

# Disassembly Instruction

## LCD Monitor

**CU34P3CV**



### **WARNING**

This disassembly information is designed for experienced repair technicians only and is not designed for use by the general public.

It does not contain warnings or cautions to advise non-technical individuals of potential dangers in attempting to service a product.

Products powered by electricity should be serviced or repaired only by experienced professional technicians. Any attempt to service or repair the product or products dealt with in this disassembly information by anyone else could result in serious injury or death.

## Content Index

General Safety Instructions .....	1
1. General Guidelines .....	1
2. Important Notice.....	1
3. How to Read this Instruction.....	3
Exploded view diagram with list of items.....	5
Disassembly SOP .....	6

## General Safety Instructions

### 1. General Guidelines

When servicing, observe the original lead dress. If a short circuit is found, replace all parts which have been overheated or damaged by the short circuit.

After servicing, see to it that all the protective devices such as insulation barriers, insulation papers shields are properly installed.

After servicing, make the following leakage current checks to prevent the customer from being exposed to shock hazards.

- 1) Leakage Current Cold Check
- 2) Leakage Current Hot Check
- 3) Prevention of Electro Static Discharge (ESD) to Electrostatically Sensitive

### 2. Important Notice

#### 2-1. Follow the regulations and warnings

Most important thing is to list up the potential hazard or risk for the service personnel to open the units and disassemble the units. For example, we need to describe properly how to avoid the possibility to get electrical shock from the live power supply or charged electrical parts (even the power is off).

#### 2-2. Be careful to the electrical shock

To prevent damage which might result in electric shock or fire, do not expose this TV set to rain or excessive moisture. This TV must not be exposed to dripping or splashing water, and objects filled with liquid, such as vases, must not be placed on top of or above the TV.

#### 2-3. Electro static discharge (ESD)

Some semiconductor (solid state) devices can be damaged easily by static electricity. Such components commonly are called Electrostatically Sensitive (ES) Devices. The following techniques should be used to help reduce the incidence of component damage caused by electrostatic discharge (ESD).

#### 2-4. About lead free solder (PbF)

This product is manufactured using lead-free solder as a part of a movement within the consumer products industry at large to be environmentally responsible. Lead-free solder must be used in the servicing and repairing of this product.

#### 2-5. Use the genuening parts (specified parts)

Special parts which have purposes of fire retardant (resistors), high-quality sound (capacitors), low noise (resistors), etc. are used.

When replacing any of components, be sure to use only manufacture's specified parts shown in the parts list.

## 2-6 Safety Check after Repairment

Confirm that the screws, parts and wiring which were removed in order to service are put in the original positions, or whether there are the positions which are deteriorated around the serviced places serviced or not. Check the insulation between the antenna terminal or external metal and the AC cord plug blades. And be sure the safety of that.

### General Servicing Precautions

1. Always unplug the receiver AC power cord from the AC power source before;
  - a. Removing or reinstalling any component, circuit board module or any other receiver assembly.
  - b. Disconnecting or reconnecting any receiver electrical plug or other electrical connection.
  - c. Connecting a test substitute in parallel with an electrolytic capacitor in the receiver.

**CAUTION:** A wrong part substitution or incorrect polarity installation of electrolytic capacitors may result in an explosion hazard.

2. Test high voltage only by measuring it with an appropriate high voltage meter or other voltage measuring device (DVM, FETVOM, etc) equipped with a suitable high voltage probe.

Do not test high voltage by "drawing an arc".

3. Do not spray chemicals on or near this receiver or any of its assemblies.
4. Do not defeat any plug/socket B+ voltage interlocks with which receivers covered by this service manual might be equipped.
5. Do not apply AC power to this instrument and/or an
6. Always connect the test receiver ground lead to the receiver chassis ground before connecting the test receiver positive lead.

Always remove the test receiver ground lead last. Capacitors may result in an explosion hazard.

7. Use with this receiver only the test fixtures specified in this service manual.

**CAUTION:** Do not connect the test fixture ground strap to any heat sink in this receiver.

8. Insulation resistance between the cord plug terminals and the external exposure metal should be more than Mohm by using the 500V insulation resistance meter.

### Electrostatically Sensitive (ES) Devices

Some semiconductor (solid-state) devices can be damaged easily by static electricity. Such components commonly are called Electrostatically Sensitive (ES) Devices. Examples of typical ES devices are integrated circuits and some field-effect transistors and semiconductor "chip" components. The following techniques should be used to help reduce the incidence of component damage caused by static by static electricity.

1. Immediately before handling any semiconductor component or semiconductor- equipped assembly, drain off any electrostatic charge on your body by touching a known earth ground. Alternatively, obtain and wear a commercially available discharging wrist strap device, which should be removed to prevent potential shock reasons prior to applying power to the unit under test.

2. After removing an electrical assembly equipped with ES devices, place the assembly on a conductive surface such as aluminum foil, to prevent electrostatic charge buildup or exposure of the assembly.
3. Use only a grounded-tip soldering iron to solder or unsolder ES devices.
4. Use only an anti-static type solder removal device. Some solder removal devices not classified as Yanti-staticY can generate electrical charges sufficient to damage ES devices.
5. Do not use freon-propelled chemicals. These can generate electrical charges sufficient to damage ES devices.
6. Do not remove a replacement ES device from its protective package until immediately before you are ready to install it.

(Most replacement ES devices are packaged with leads electrically shorted together by conductive foam, aluminum foil or comparable conductive material).

7. Immediately before removing the protective material from the leads of a replacement ES device, touch the protective material to the chassis or circuit assembly into which the device will be installed.

**CAUTION:** Be sure no power is applied to the chassis or circuit, and observe all other safety precautions.

8. Minimize bodily motions when handling unpackaged replacement ES devices. (Otherwise harmless motion such as the brushing together of your clothes fabric or the lifting of your foot from a carpeted Qoor can generate static electricity sufficient to damage an ES device.)

## 2-7. Ordering Spare Parts

Please include the following informations when you order parts. (Particularly the Version letter)

1. Model number, Serial number and Software Version

The model number and Serial number can be found on the back of each product and the Software Version can be found at the Spare Parts List.

2. Spare Part No. and Description

You can find them in the Spare Parts List

## 2-8. Photo used in this manual

The illustration and photos used in this Manual may not base on the final design of products, which may differ from your products in some way.

## 3. How to Read this Instruction

Using Icons:

Icons are used to attract the attention of the reader to specific information. The meaning of each icon is described in the table below:

### Note:

A “note” provides information that is not indispensable, but may nevertheless be valuable to the reader, such as tips and tricks.

### Caution:

A “caution” is used when there is danger that the reader, through incorrect manipulation, may damage equipment, loose data, get an unexpected result or has to restart(part of) a procedure.

**Warning:**

A “warning” is used when there is danger of personal injury.

**Reference:**

A “reference” guides the reader to other places in this binder or in this manual, where he/ she will find additional information on a specific topic.

## Exploded view diagram with list of items

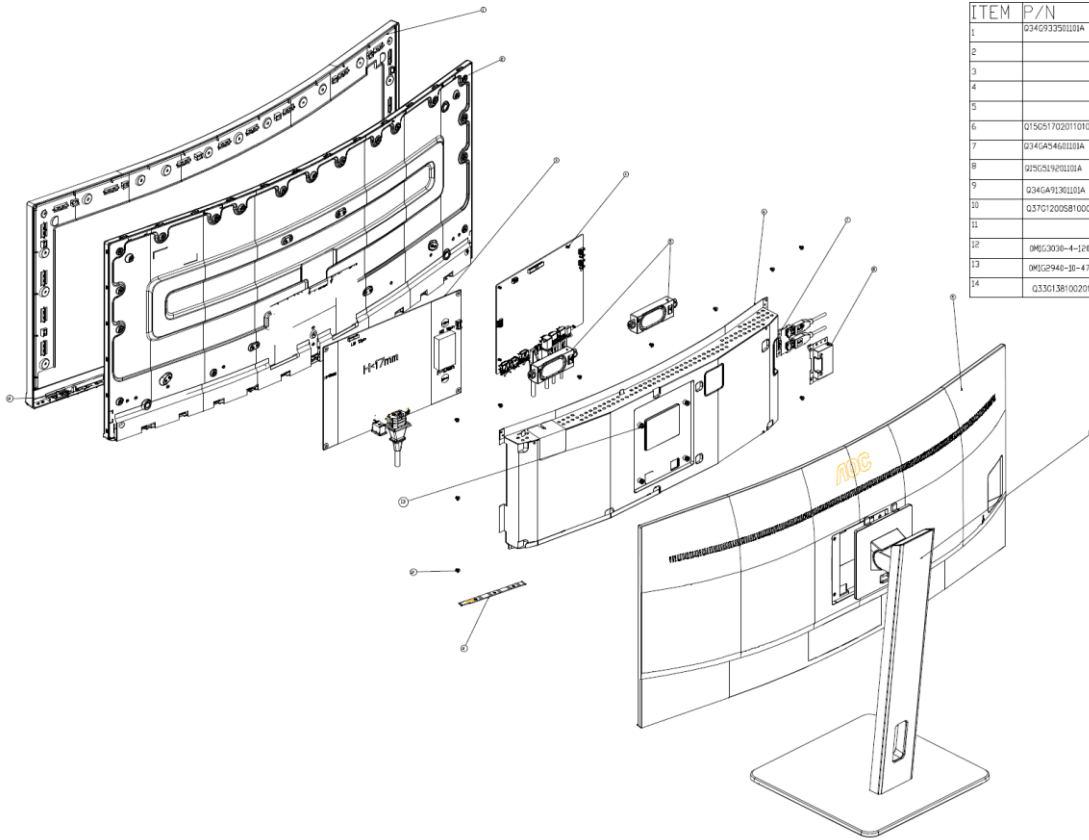

ITEM	P/N	PART NAME	Q'TY	NOTES
1	Q34G93350101A	MIDDLE_FRAME	1	
2	TPM349Y1-55R402 21B		1	
3	PV8_288x285		1	
4	pcalar_PCB_212x150		1	
5	SPK		2	
6	Q150517020110100B1	MoVFrame	1	
7	Q34GA5460101A	USB_PCB_25X44	1	
8	Q25051920101A	bbt_sH4_3s	1	
9	Q34GA9130101A	Rear_Cover	1	
10	Q37012005810000SHL	Stand_ASM	1	
11		KEY_PCB	1	
12	0M6C3030-4-128	M3X4	13	
13	0M6C940-10-47-CR3	M4X10	4	
14	Q33C138100201C0100	LENS_LED	1	

## Disassembly SOP

### 1. Suggest Tools

Here are some tools that can be used for the LCD monitor's service and repair.

#### Philips-head Screwdriver

Use a Philips-head screwdriver to fasten/remove the K- or B-typed screws



P/N: N/A

#### Gloves

To protect LCD Panel and your hand



P/N: (L) N/A (M) N/A

#### C/D Disassembly Tool

Use C/D Disassembly Tool to open cosmetic cover and avoid scratch.



P/N: N/A

#### Spacer Screwdriver

Use a spacer screwdriver to fasten/remove spacer screws or hex screws.



P/N: N/A



## 2. Disassembly Procedures

1. Remove the stand-base assy.

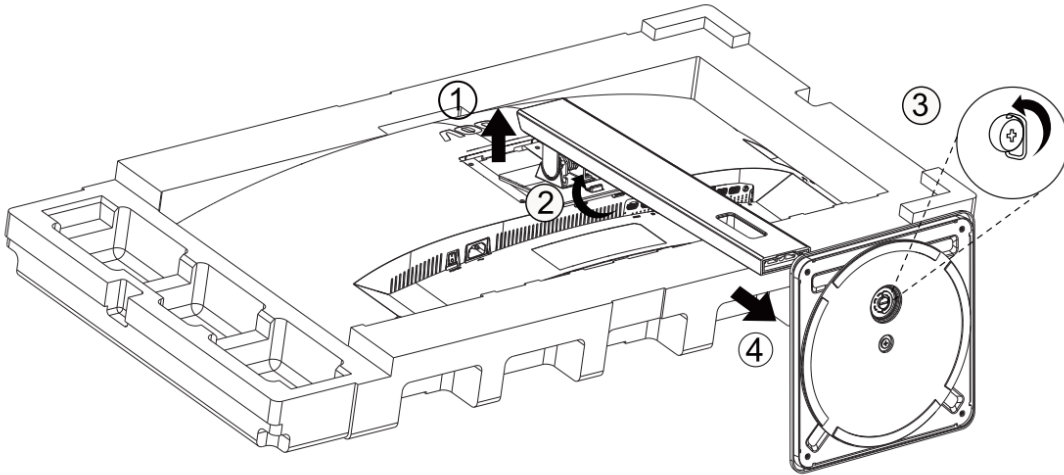

2. Remove the screws.

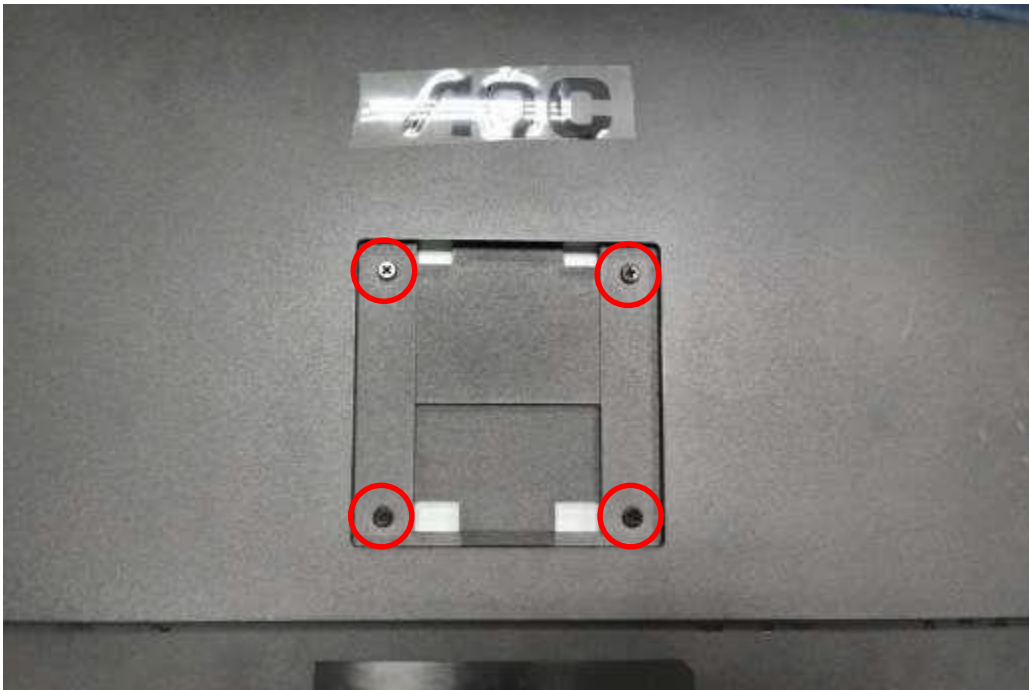

3. Use disassembly tool to open all the latches along the edge of the rear cover.



4. Take off the tape and disconnect the connector.

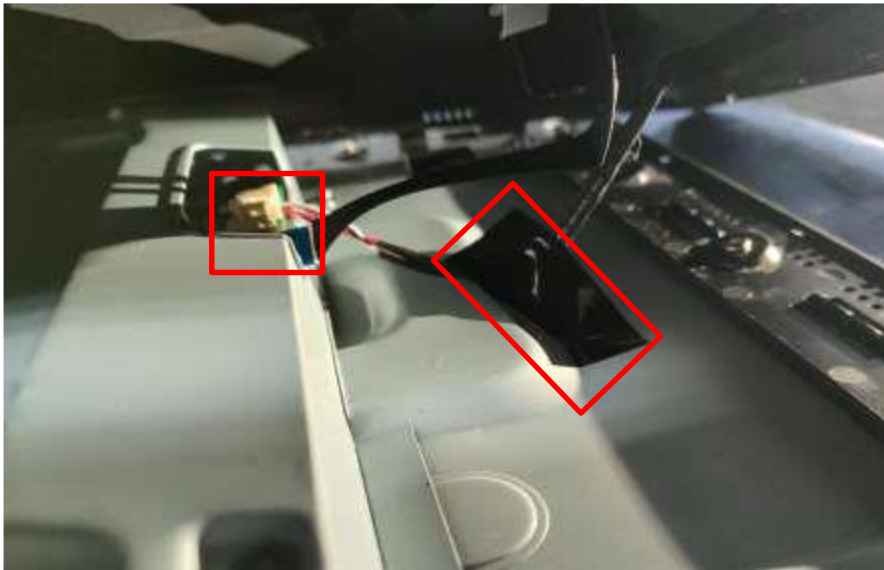

5. Take off all of the tapes and disconnect the connectors.

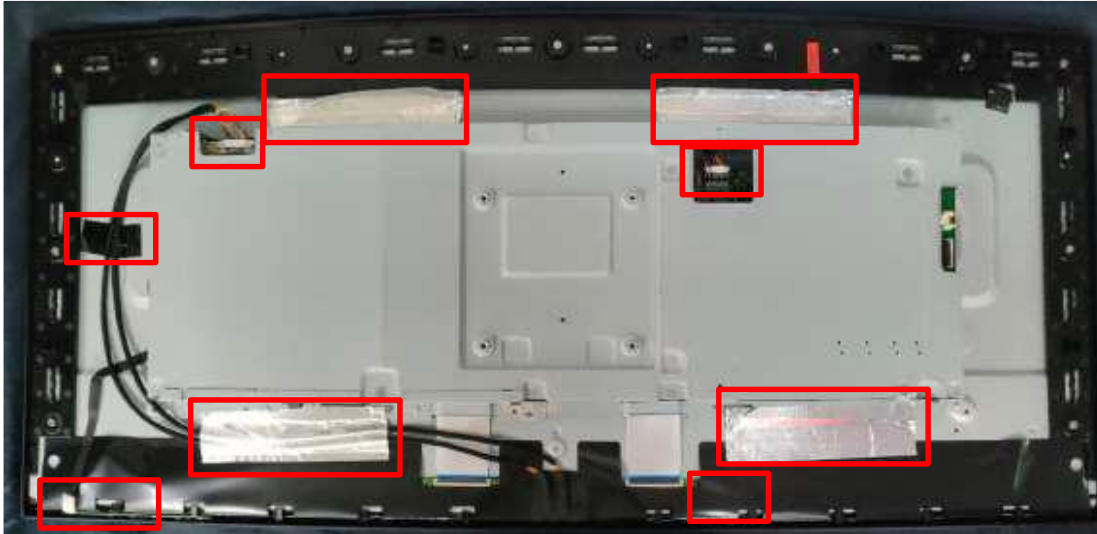

6. Remove the screws.

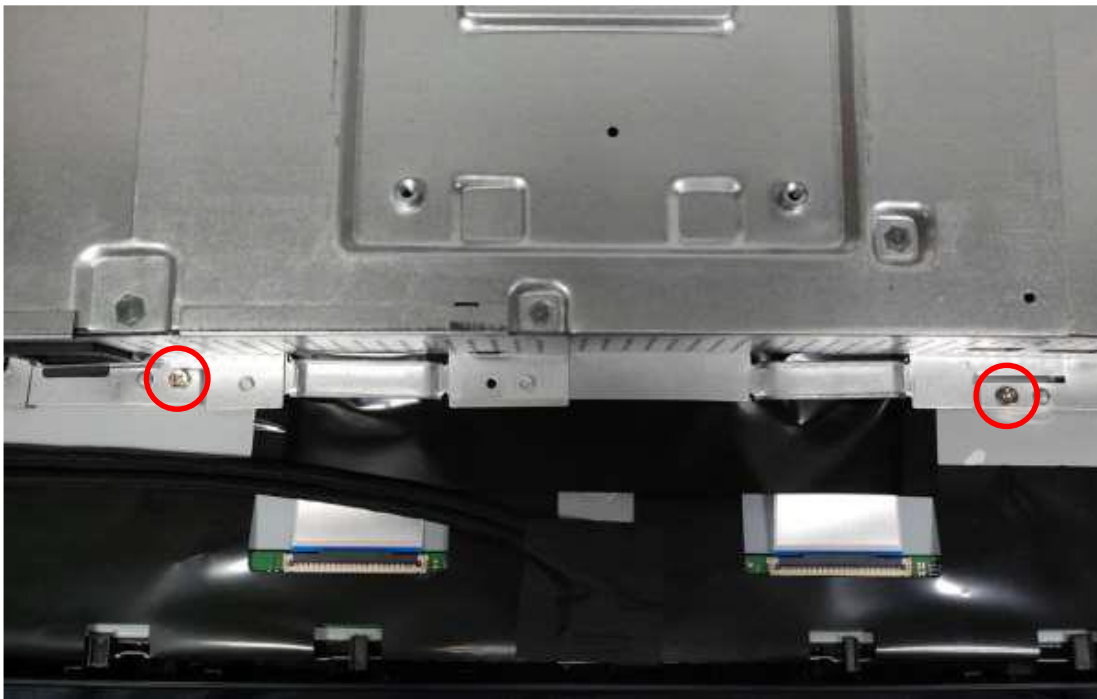

7. Take off tape and disconnect the connector.

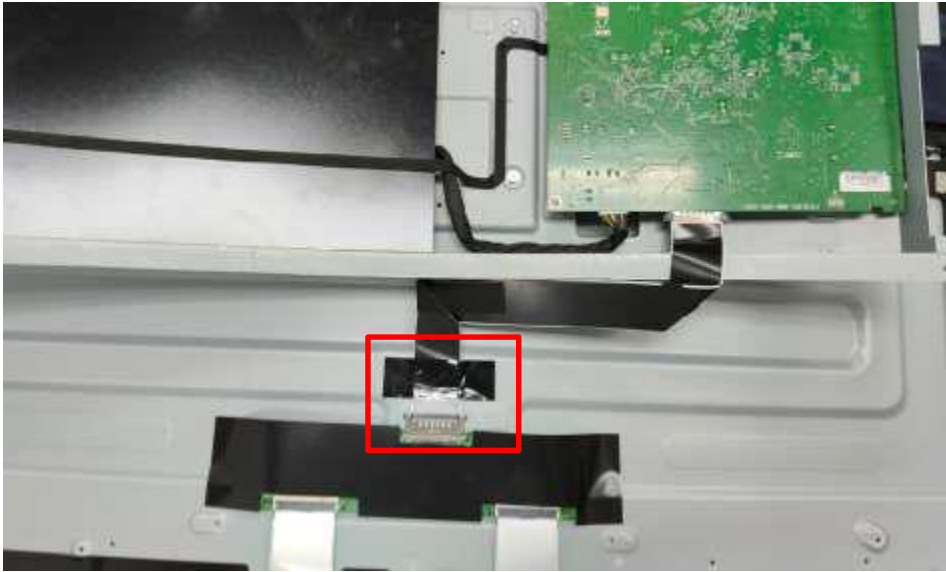

8. Remove Mylar.



9. Remove screws to get boards.

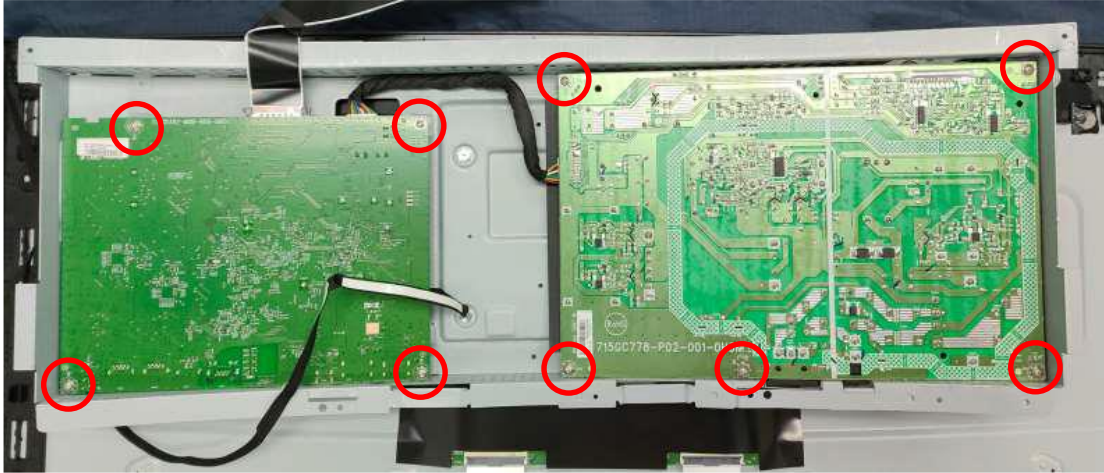

10. Remove screws to get panel and middle frame.

