

TPV Electronics (Fujian) Co., Ltd.
Mr. Xinliang Wu
RD-SE
Rongqiao Economic and
Technological Development Zone
Fuqing City, Fujian Province
P.R. China

Date : 05.05.2017
Our ref. : WangAn ZJ
Your ref.: 1140033444

Ref : CB Certificate Japan

Type of Equipment : LCD Monitor
Model Designation : See Certificate
Certificate No. : JPTUV-080331
Report No. : 17059694 001

Dear Mr. Xinliang Wu,

Thank you very much for your interest in our services.

Please find enclosed your certification documents.

We appreciate your support and would like to offer our assistance in the approval of your future products through our extensive range of technical services.

Please feel free to contact us whatever your requirements may be.

With kind regards,

Certification Body

Dipl.-Ing. Univ. S. O. Steinke 

Enclosure

证书的详细资料请登陆www.certipedia.com查阅,或拨打我司客服热线800 999 3668 / 400 883 1300咨询

IEC SYSTEM FOR MUTUAL RECOGNITION OF TEST
CERTIFICATES FOR ELECTRICAL EQUIPMENT
(IECEE) CB SCHEME

SYSTEME CEI D'ACCEPTATION MUTUELLE DE
CERTIFICATS D'ESSAIS DES EQUIPEMENTS
ELECTRIQUES (IECEE) METHODE OC

CB TEST CERTIFICATE

CERTIFICAT D'ESSAI OC

Product
Produit

LCD Monitor

Name and address of the applicant
Nom et adresse du demandeur

TPV Electronics (Fujian) Co., Ltd.
Rongqiao Economic and
Technological Development Zone, Fuqing City, Fujian Province, P.R.
China

Name and address of the manufacturer
Nom et adresse du fabricant

TPV Electronics (Fujian) Co., Ltd.
Rongqiao Economic and
Technological Development Zone, Fuqing City, Fujian Province, P.R.
China

Name and address of the factory
Nom et adresse de l'usine

See additional page(s)

Ratings and principal characteristics
Valeurs nominales et caractéristiques principales

AC 100-240V; 50/60Hz; 1.5A; Class I

Trademark (if any)
Marque de fabrique (si elle existe)

AOC

Type of Manufacturer's Testing Laboratories used
Type de programme du laboratoire d'essais constructeur

N/A

Model / Type Ref.
Ref. de type

238LM000**, **2490*****; 270LM000**, **2790*****
(* = 0-9, A-Z, a-z, +, -, /, \ or blank)

Additional information (if necessary may also be
reported on page 2)
Les informations complémentaires (si nécessaire,
peuvent être indiqués sur la 2^{ème} page)

For model differences, refer to the test report.

A sample of the product was tested and found
to be in conformity with
Un échantillon de ce produit a été essayé et a été
considéré conforme à la

IEC 60950-1:2005+A1+A2
See Test Report for National Differences

As shown in the Test Report Ref. No. which forms part
of this Certificate
Comme indiqué dans le Rapport d'essais numéro de
référence qui constitue partie de ce Certificat

17059694 001

This CB Test Certificate is issued by the National Certification Body
Ce Certificat d'essai OC est établi par l'Organisme National de Certification



TÜV Rheinland Japan Ltd.
Global Technology Assessment Center
4-25-2 Kita-Yamata, Tsuzuki-ku
Yokohama 224-0021 Japan
Phone + 81 45 914-3888
Fax + 81 45 914-3354
Mail: info@jpn.tuv.com
Web: www.tuv.com

Date: 05.05.2017

Signature:

Dipl.-Ing. Univ. S. O. Steinke

1. TPV Display Technology (Wuhan) Co., Ltd.
Unique No. 11, Zhuankou Development District of Economic Technological Development Zone, Wuhan City 430056, P.R. China
2. TPV Electronics (Fujian) Co., Ltd.
Shangzheng, Yuan Hong Road
Fuqing City, Fujian Province
P.R. China
3. Envision Industry of Electronic Products Ltd.
Rodovia Anhanguera S/N-KM 49
Tijuco Preto-Jundiaí-SP-
13.205-700, Brazil
4. L&T Display Technology (Fujian) Ltd.
Optoelectronic Park, Rongqiao Economic and Technological Development Zone
Fuqing, Fujian 350301, P.R. China
5. TPV Electronics (Fujian) Co., Ltd.
Rongqiao Economic and Technological Development Zone
Fuqing City, Fujian Province
P.R. China
6. Trend Smart CE Mexico S de RL de CV
Avenida Sor Juana Ines de la Cruz de 19602 Nueva Tijuana,
22435 Tijuana Baja California
MEXICO
7. TPV Display Technology (Beihai) Co., Ltd.
China Electronic Beihai Industry Park, Northeast of the Crossing
Between Taiwan Road and Jilin Road, Beihai City, Guangxi, P.R. China
8. TPV Technology (Qingdao) Co., Ltd.
No 99 Huoju Road, High-tech Industrial Development Zone
Qingdao City, Shandong Province, P.R. China
9. TPV Display Technology (China) Co., Ltd.
No. 106 Jinghai 3 Rd., BDA
Beijing City 100176
P.R. China

Additional information (if necessary)
Information complémentaire (si nécessaire)

Report Ref. No.: 17059694 001



Date: 05.05.2017

Signature:

Dipl.-Ing. Univ. S. O. Steinke

10. Hefei Huntkey Display Technology Co., Ltd.
South Jinxiu Road, East Qingtan Road
Economic And Technological
Development Zone, Hefei, Anhui 230601, P.R. China
11. TPV Electronics (Fujian) Co., Ltd.
Optoelectronic Park,
Rongqiao Economic and
Technological Development Zone,
Fuqing City, Fujian Province 350301, P.R. China
12. Envision Indústria de Produtos
Eletrônicos Ltda.
Av. Torquato Tapajós, 2236,
Flores - CEP 69058-830 - Manaus/AM
Brazil

Additional information (if necessary)
Information complémentaire (si nécessaire)

Report Ref. No.: 17059694 001

Date: 05.05.2017

Signature:

Dipl.-Ing Univ. S. O. Steinke



Test Report issued under the responsibility of:



TEST REPORT
IEC 60950-1
Information technology equipment – Safety –
Part 1: General requirements

Report Number..... : 17059694 001
 Date of issue..... : Apr.25. 2017
 Total number of pages : 93

Applicant's name : **TPV Electronics (Fujian) Co., Ltd.**
 Address..... : Rongqiao Economic and Technological Development Zone,
 Fuqing City, Fujian Province, P.R.China

Test specification:
 Standard : IEC 60950-1:2005 (Second Edition) + Am 1:2009 + Am 2:2013
 Test procedure..... : CB Scheme
 Non-standard test method..... : N/A

Test Report Form No. : IEC60950_1F
 Test Report Form(s) Originator.... : SGS Fimko Ltd
 Master TRF : Dated 2014-02

Copyright © 2014 IEC System of Conformity Assessment Schemes for Electrotechnical Equipment and Components (IECEE System). All rights reserved.

This publication may be reproduced in whole or in part for non-commercial purposes as long as the IECEE is acknowledged as copyright owner and source of the material. IECEE takes no responsibility for and will not assume liability for damages resulting from the reader's interpretation of the reproduced material due to its placement and context.

If this Test Report Form is used by non-IECEE members, the IECEE/IEC logo and the reference to the CB Scheme procedure shall be removed.

This report is not valid as a CB Test Report unless signed by an approved CB Testing Laboratory and appended to a CB Test Certificate issued by an NCB in accordance with IECEE 02.

General disclaimer:
 The test results presented in this report relate only to the object tested.
 This report shall not be reproduced, except in full, without the written approval of the Issuing CB Testing Laboratory. The authenticity of this Test Report and its contents can be verified by contacting the NCB, responsible for this Test Report.

Test item description..... : LCD Monitor
 Trade Mark..... : AOC
 Manufacturer : Same as applicant.
 Model/Type reference..... : 238LM000**, **2490*****, 270LM000**, **2790*****
 (* can be 0-9, A-Z, a-z, "+", "-", "/", "\" or blank, Represent different enclosure color and sales region for marketing purpose. No technology differences)
 Ratings..... : I/P: 100-240Vac, 50/60Hz, 1.5A

Testing procedure and testing location:		
<input checked="" type="checkbox"/>	CB Testing Laboratory:	TÜV Rheinland (Shenzhen) Co., Ltd.
Testing location/ address		East of F/1, F/2~F/4, Building 1, Cybio Technology Building No. 6 Langshan No.2 Road, North Hi-tech Industry Park 518057 Shenzhen Nanshan District CHINA
<input type="checkbox"/>	Associated CB Testing Laboratory:	
Testing location/ address		
Tested by (name + signature)		Anderson Wang Senior Project Manager 
Approved by (name + signature)		Aegean Li Technical Reviewer 
<input type="checkbox"/>	Testing procedure: TMP/CTF Stage 1:	
Testing location/ address		
Tested by (name + signature)		
Approved by (name + signature)		
<input type="checkbox"/>	Testing procedure: WMT/CTF Stage 2:	
Testing location/ address		
Tested by (name + signature)		
Witnessed by (name + signature)		
Approved by (name + signature)		
<input type="checkbox"/>	Testing procedure: SMT/CTF Stage 3 or 4:	
Testing location/ address		
Tested by (name + signature)		
Witnessed by (name + signature)		
Approved by (name + signature)		
Supervised by (name + signature)		

List of Attachments (including a total number of pages in each attachment):

- Photo documentation
- National Differences
- Appendix ZZ

Total number of pages in each attachment is indicated in individual attachment.

Summary of testing:**Tests performed (name of test and test clause):**

Following tests performed during evaluation

name of test	test clause number
Input Current Test	1.6.2
Durability of Marking Test	1.7.11
Access to energized parts	2.1.1.1
Energy hazard in Operator Access Area	2.1.1.5
Discharge of Capacitors	2.1.1.7
SELV limits for Normal Conditions	2.2.2
SELV limits for Abnormal Conditions	2.2.3
Limited current circuits	2.4
Limited power source	2.5
Resistance of Earthing Circuit	2.6.3.4
Humidity Conditioning	2.9.2
Working Voltage over Insulation	2.10.2
Clearance and creepage distance measurements	2.10.3 & 2.10.4
Stability test	4.1
Steady force test, 10 N	4.2.2
Steady Force Test, 30N	4.2.3
Steady Force Test, 250N	4.2.4
Impact Test (Steel Ball)	4.2.5
Stress Relief Test	4.2.7
Maximum Temperature Test	4.5.2
Ball pressure test	4.5.5
Openings in enclosures	4.6
Touch Current and PE current	5.1.6
Electric Strength Test	5.2
Fault Condition Test	5.3
Note:	

Testing location:

All tests as described in Test Case and Measurement Sections were performed at the laboratory described on page 2.

Summary of compliance with National Differences

List of countries addressed:

EU Group Differences, EU Special National Conditions, EU A-Deviations, AT, AU*, BE, CA, CH, CN, CZ, DE, DK, FI, FR, GB, GR, HU, IT, IL*, JP*, KR*, NL, NO, PL, SE, SI, SK, US

Explanation of used codes: AT=Austria, AU=Australia, BE=Belgium, CA=Canada, CH=Switzerland, CN=P.R.China, CZ=Czech Republic, DE=Germany, DK=Denmark, FI=Finland, FR=France, GB=United Kingdom, GR=Greece, HU=Hungary, IT=Italy, IL=Israel, JP=Japan, KR=Korea, NL=The Netherlands, NO=Norway, PL=Poland, SE=Sweden, SI=Slovenia, SK=Slovakia, US=United States of America

For National Differences see end of this test report.

* National differences to IEC 60950-1:2005 (Second Edition) + Am 1:2009 evaluated.

The product fulfils the requirements of EN 60950-1:2006 + A11: 2009 + A1: 2010 +A12: 2011 +A2: 2013

Copy of marking plate

The artwork below may be only a draft. The use of certification marks on a product must be authorized by the respective NCBs that own these marks.

AOC LCD monitor (LED Backlight)
 Product No./Nama Produk: I2490VXQ
 Model No.: 238LM00023
 Power Rating/Tegangan: 100V-240V~ 50/60Hz 1.5A
 AOC International Europe B.V.
 Amstelgebouw, 6th floor
 Prins Bernhardplein 200
 1097 JB Amsterdam
 The Netherlands

Envision Peripherals, Inc.
 47490 Seabridge Drive
 Fremont, CA 94538
 USA

Warning: Shock Hazard, Do Not Open.
 Pour éviter une électrocution, ne retirez pas le couvercle!
 www.aoc.com Made in China

AOC LCD monitor (LED Backlight)
 Product No./Nama Produk: I2790VH
 Model No.: 270LM00042
 Power Rating/Tegangan: 100V-240V~ 50/60Hz 1.5A
 AOC International Europe B.V.
 Amstelgebouw, 6th floor
 Prins Bernhardplein 200
 1097 JB Amsterdam
 The Netherlands

Envision Peripherals, Inc.
 47490 Seabridge Drive
 Fremont, CA 94538
 USA

Warning: Shock Hazard, Do Not Open.
 Pour éviter une électrocution, ne retirez pas le couvercle!
 www.aoc.com Made in China

The above label represents labels for model names other than above covered by the model name.

Test item particulars	
Equipment mobility	<input checked="" type="checkbox"/> movable (for unit with stand base) <input type="checkbox"/> hand-held <input type="checkbox"/> transportable <input checked="" type="checkbox"/> stationary (for unit without stand base) <input type="checkbox"/> for building-in <input type="checkbox"/> direct plug-in
Connection to the mains	<input checked="" type="checkbox"/> pluggable equipment <input checked="" type="checkbox"/> type A <input type="checkbox"/> type B <input type="checkbox"/> permanent connection <input checked="" type="checkbox"/> detachable power supply cord <input type="checkbox"/> non-detachable power supply cord <input type="checkbox"/> not directly connected to the mains
Operating condition	<input checked="" type="checkbox"/> continuous <input type="checkbox"/> rated operating / resting time:
Access location	<input checked="" type="checkbox"/> operator accessible <input type="checkbox"/> restricted access location
Over voltage category (OVC)	<input type="checkbox"/> OVC I <input checked="" type="checkbox"/> OVC II <input type="checkbox"/> OVC III <input type="checkbox"/> OVC IV <input type="checkbox"/> other:
Mains supply tolerance (%) or absolute mains supply values	±10% (requested by client)
Tested for IT power systems	<input type="checkbox"/> Yes <input checked="" type="checkbox"/> No
IT testing, phase-phase voltage (V)	
Class of equipment	<input checked="" type="checkbox"/> Class I <input type="checkbox"/> Class II <input type="checkbox"/> Class III <input type="checkbox"/> Not classified
Considered current rating of protective device as part of the building installation (A)	16A (20A for North America)
Pollution degree (PD)	<input type="checkbox"/> PD 1 <input checked="" type="checkbox"/> PD 2 <input type="checkbox"/> PD 3
IP protection class	IPX0
Altitude during operation (m)	≤5000
Altitude of test laboratory (m)	<2000
Mass of equipment (kg)	Approx. 3.63kg (for 23.8 inch model with base stand); approx. 4.52kg (for 27.0 inch model with base stand); base stand type A: 0.65kg; base stand type B: 1.69kg
Possible test case verdicts:	
- test case does not apply to the test object N/A	
- test object does meet the requirement P (Pass)	
- test object does not meet the requirement F (Fail)	
Testing	
Date of receipt of test item	Mar.08.2017
Date(s) of performance of tests	Apr.01.2017-Apr.24.2017
General remarks:	
"(See Enclosure #)" refers to additional information appended to the report. "(See appended table)" refers to a table appended to the report. Throughout this report a <input type="checkbox"/> comma / <input checked="" type="checkbox"/> point is used as the decimal separator.	

Manufacturer's Declaration per sub-clause 4.2.5 of IEC60950-1:

The application for obtaining a CB Test Certificate includes more than one factory location and a declaration from the Manufacturer stating that the sample(s) submitted for evaluation is (are) representative of the products from each factory has been provided.....

 Yes **Not applicable****When differences exist; they shall be identified in the General product information section.**

Name and address of factory (ies)	
1	TPV Display Technology (Wuhan) Co., Ltd. Unique No. 11, Zhuankou Development District of Economic Technological Development Zone, Wuhan City 430056, P.R. China
2	TPV Electronics (Fujian) Co., Ltd. Shangzheng, Yuan Hong Road, Fuqing City, Fujian Province, P.R. China
3	Envision Industry of Electronic Products Ltd. Rodovia Anhanguera S/N-KM 49 Tijuco Preto- Jundiaí-SP-13.205-700, Brazil
4	L&T Display Technology (Fujian) Ltd. Optoelectronic Park, Rongqiao Economic and Technological, Development Zone, Fuqing, Fujian 350301, P.R. China
5	TPV Electronics (Fujian) Co., Ltd. Rongqiao Economic and Technological Development Zone, Fuqing City, Fujian Province, P.R. China
6	Trend Smart CE Mexico S de RL de CV Avenida Sor Juana Ines de la Cruz de 19602 Nueva Tijuana, 22435 Tijuans Baja California, MEXICO
7	TPV Display Technology (Beihai) Co., Ltd. China Electronic Beihai Industry Park, Northeast of the Crossing Between Taiwan Road and Jilin Road, Beihai City, Guangxi, P.R. China
8	TPV Technology (Qingdao) Co., Ltd. No.99 Huoju Road, High-tech Industrial Development Zone, Qingdao City, Shandong Province, P.R. China
9	TPV Display Technology (China) Co., Ltd. No.106 Jinghai 3 Rd., BDA, Beijing City 100176, P.R. China.
10	Hefei Huntkey Display Technology Co.,Ltd. South Jinxiu Road, East Qingtan Road, Economic And Technological Development Zone, Hefei, Anhui 230601, P.R. China
11	TPV Electronics (Fujian) Co., Ltd. Optoelectronic Park, Rongqiao Economic and Technological Development Zone, Fuqing City, Fujian Province 350301, P.R. China
12	Envision Indústria de Produtos Eletrônicos Ltda. Av. Torquato Tapajós, 2236, Flores - CEP 69058-830 - Manaus/AM Brasil

General product information:

The models mentioned in cover page are LCD Monitors intended for using within the scope of information technology equipment. The unit has the following features:

1. LCD Type: TFT LCD with LED backlight;
2. Building-in power supply boards **715G7300** and **715G8852**;
3. Building-in main boards: **715G8776** with HDMI, DisplayPort, VGA, Audio-in and Audio-out ports,
715G7762 with HDMI, DisplayPort, DVI, VGA, Audio-in and Audio-out ports,
715G8853 with HDMI x 2, DisplayPort, VGA, Audio-in and Audio-out ports,
715G7778 with HDMI, VGA and Audio-out ports,
which are supplied by 19V output of power board 715G8852 or V_{out} of power board 715G7300 mentioned above;
4. USB board 715G8765, which is supplied by main board mentioned above as L.P.S.;
5. The external plastic enclosure is regarded as electrical enclosure and mechanical enclosure, made of min. HB material;
6. The internal metal chassis is considered as electrical enclosure, mechanical enclosure and fire enclosure;
7. Maximum declared ambient: 40°C;
8. The equipment is operated to 5000m sea level as declared by manufacturer.

See below table for construction details:

Model	Panel size	Power board	Main board	USB board	Plastic enclosure	Metal enclosure	Base
238LM000** **2490*****	23.8 inch	715G7300	715G8776	N/A	Type A	Type A	Type A
		715G8852 type A	715G8776	715G8765		Type B	Type B
		715G8852 type B	715G7762	N/A		Type A	
270LM000** **2790*****	27.0 inch	715G7300	715G8776 715G7778	N/A	Type A'	Type A	Type A
		715G8852 type A	715G8776	715G8765		Type B	Type B
		715G8852 type C	715G8853				

Note:

1. Base type A is stationary base, base type B is rotatable base;
2. Plastic enclosure Type A is identical to type A' except for smaller size of appearance due to different panel size;
3. Power board type B is identical to type A except for: 1) different construction of line chock L901; 2) Bridging Diode BD902 is optional; 3) X-cap C903 is optional; 4) different size of Heat sink HS901; 5) slight different in secondary circuit; 6) used without USB board;
4. Power board type C is identical to type A except for slight different in secondary circuit.

Definition of variable(s):																		
Variable:	Range of variable:	Content:																
*	0-9, A-Z, a-z, "+", "-", "/", "\" or blank	Represent different enclosure color and sales region for marketing purpose. No technology differences																
<p>Additional information:</p> <ul style="list-style-type: none"> The manufacturer declared that the product also fulfilled of the requirements of SANS 60950-1: 2014 (Edition 2.2) / IEC 60950-1: 2013 (Edition 2.2). The speaker jack has also been tested and found in compliance with the requirements of EN 50332-2. Measured output power of the speaker jack: Max. 90mV. <p>Other comments: Declaration of the manufacturer: the sample(s) submitted for evaluation is (are) representative of the products from each factory.</p>																		
<p>Abbreviations used in the report:</p> <table> <tbody> <tr> <td>- normal conditions</td> <td>N.C.</td> <td>- single fault conditions</td> <td>S.F.C</td> </tr> <tr> <td>- functional insulation</td> <td>OP</td> <td>- basic insulation</td> <td>BI</td> </tr> <tr> <td>- double insulation</td> <td>DI</td> <td>- supplementary insulation</td> <td>SI</td> </tr> <tr> <td>- between parts of opposite polarity</td> <td>BOP</td> <td>- reinforced insulation</td> <td>RI</td> </tr> </tbody> </table> <p>Indicate used abbreviations (if any)</p>			- normal conditions	N.C.	- single fault conditions	S.F.C	- functional insulation	OP	- basic insulation	BI	- double insulation	DI	- supplementary insulation	SI	- between parts of opposite polarity	BOP	- reinforced insulation	RI
- normal conditions	N.C.	- single fault conditions	S.F.C															
- functional insulation	OP	- basic insulation	BI															
- double insulation	DI	- supplementary insulation	SI															
- between parts of opposite polarity	BOP	- reinforced insulation	RI															

IEC 60950-1			
Clause	Requirement + Test	Result - Remark	Verdict
1	GENERAL		P
1.5	Components		P
1.5.1	General		P
	Comply with IEC 60950-1 or relevant component standard	(see appended table 1.5.1)	P
1.5.2	Evaluation and testing of components	Components which are certified to IEC and/or national standards are used correctly within their ratings. Components not covered by IEC standards are tested under the conditions present in the equipment.	P
1.5.3	Thermal controls	No thermal controls.	N/A
1.5.4	Transformers	Transformers used are suitable for their intended application and comply with the relevant requirements of the standard and particularly Annex C.	P
1.5.5	Interconnecting cables	Interconnecting cable does not carry voltage higher than SELV and no higher energy level than 240VA.	P
1.5.6	Capacitors bridging insulation	Between lines: X1 or X2 capacitors according to IEC 60384-14 used. Between primary and earth: Y1 or Y2 capacitors according to IEC 60384-14 used. Between primary and unearthed secondary: Y1 capacitors according to IEC 60384-14 used. (see appended table 1.5.1)	P
1.5.7	Resistors bridging insulation		P
1.5.7.1	Resistors bridging functional, basic or supplementary insulation	Only discharge resistors bridging between L-N (functional)	P
1.5.7.2	Resistors bridging double or reinforced insulation between a.c. mains and other circuits		N/A
1.5.7.3	Resistors bridging double or reinforced insulation between a.c. mains and antenna or coaxial cable		N/A
1.5.8	Components in equipment for IT power systems		N/A

IEC 60950-1			
Clause	Requirement + Test	Result - Remark	Verdict
1.5.9	Surge suppressors		N/A
1.5.9.1	General		N/A
1.5.9.2	Protection of VDRs		N/A
1.5.9.3	Bridging of functional insulation by a VDR		N/A
1.5.9.4	Bridging of basic insulation by a VDR		N/A
1.5.9.5	Bridging of supplementary, double or reinforced insulation by a VDR		N/A

1.6	Power interface		P
1.6.1	AC power distribution systems	TN power system	P
1.6.2	Input current	(see appended table 1.6.2)	P
1.6.3	Voltage limit of hand-held equipment	This appliance is not hand-held equipment.	N/A
1.6.4	Neutral conductor	The neutral conductor insulated from earth and from the body throughout the equipment as if it were a line conductor	P

1.7	Marking and instructions		P
1.7.1	Power rating and identification markings	See below.	P
1.7.1.1	Power rating marking	See below.	P
	Multiple mains supply connections.....:		N/A
	Rated voltage(s) or voltage range(s) (V)	See copy of marking plate for details	P
	Symbol for nature of supply, for d.c. only	AC source	N/A
	Rated frequency or rated frequency range (Hz)	See copy of marking plate for details	P
	Rated current (mA or A)	See copy of marking plate for details	P
1.7.1.2	Identification markings	See below.	P
	Manufacturer's name or trade-mark or identification mark	See copy of marking plate for details	P
	Model identification or type reference	See copy of marking plate for details	P
	Symbol for Class II equipment only	Class I equipment.	N/A
	Other markings and symbols	Additional symbol or marking does not give rise to misunderstanding.	P

IEC 60950-1			
Clause	Requirement + Test	Result - Remark	Verdict
1.7.1.3	Use of graphical symbols	Graphical symbols used according to IEC 60417 or ISO 3864-2 or ISO 7000.	P
1.7.2	Safety instructions and marking	English safety instruction provided.	P
1.7.2.1	General		P
1.7.2.2	Disconnect devices	AC inlet serves as disconnect device.	P
1.7.2.3	Overcurrent protective device	Not type B pluggable equipment or permanently connected equipment.	N/A
1.7.2.4	IT power distribution systems	TN power system.	N/A
1.7.2.5	Operator access with a tool	No such access required.	N/A
1.7.2.6	Ozone	Ozone not used or generated.	N/A
1.7.3	Short duty cycles	Equipment is designed for continuous operation.	N/A
1.7.4	Supply voltage adjustment	Single input voltage range without adjustment.	N/A
	Methods and means of adjustment; reference to installation instructions		N/A
1.7.5	Power outlets on the equipment	No power outlets provided.	N/A
1.7.6	Fuse identification (marking, special fusing characteristics, cross-reference)	<p>For power board 715G7300: The fuse marking is marked near fuse on PCB as follow: F901 (on primary): T3.15AL/250Vac</p> <p>CAUTION: FOR CONTINUED PROTECTION AGAINST RISK OF FIRE, REPLACE ONLY WITH SAME TYPE AND RATING OF FUSE.</p> <p>For power board 715G8852: The fuse marking is marked near fuse on PCB as follow: F901 (on primary): T4AL/250Vac</p> <p>CAUTION: FOR CONTINUED PROTECTION AGAINST RISK OF FIRE, REPLACE ONLY WITH SAME TYPE AND RATING OF FUSE.</p> <p>Not located in operator access areas.</p>	P

IEC 60950-1			
Clause	Requirement + Test	Result - Remark	Verdict
1.7.7	Wiring terminals	See below.	P
1.7.7.1	Protective earthing and bonding terminals	AC inlet used. Symbol marked beside earthing pin of AC inlet	P
1.7.7.2	Terminals for a.c. mains supply conductors	The equipment is not permanently connected or provided with a non-detachable power supply cord	N/A
1.7.7.3	Terminals for d.c. mains supply conductors	Not connected to d.c. mains	N/A
1.7.8	Controls and indicators	See below	P
1.7.8.1	Identification, location and marking	"STAND-BY" condition is indicated by the symbol according to IEC 60417-5009.	P
1.7.8.2	Colours	Colours used for LED indicate the operation status and not involved safety.	N/A
1.7.8.3	Symbols according to IEC 60417	See 1.7.8.1	P
1.7.8.4	Markings using figures	No figures used.	N/A
1.7.9	Isolation of multiple power sources	Only one supply voltage range provided.	N/A
1.7.10	Thermostats and other regulating devices	No such components.	N/A
1.7.11	Durability	The label was subjected to the permanence of marking test. The label was rubbed with cloth soaked with water for 15 sec. and then again for 15 sec. with the cloth soaked with petroleum spirit. After this test there was no damage to the label. The marking on the label did not fade. There was no curling or lifting of the label edge.	P
1.7.12	Removable parts	None.	N/A
1.7.13	Replaceable batteries	No batteries.	N/A
	Language(s)		—
1.7.14	Equipment for restricted access locations	Equipment not intended for installation in restricted access locations.	N/A
2	PROTECTION FROM HAZARDS		P
2.1	Protection from electric shock and energy hazards		P
2.1.1	Protection in operator access areas	Only SELV signal interface accessible by operator.	P

IEC 60950-1			
Clause	Requirement + Test	Result - Remark	Verdict
2.1.1.1	Access to energized parts	See below	P
	Test by inspection	Protection established by plastic enclosure.	P
	Test with test finger (Figure 2A)	Protection established by plastic enclosure.	P
	Test with test pin (Figure 2B)	No access to any energized parts with the removable stand detached.	P
	Test with test probe (Figure 2C)		N/A
2.1.1.2	Battery compartments	No battery compartment.	N/A
2.1.1.3	Access to ELV wiring	No ELV wiring in operator accessible area.	N/A
	Working voltage (V_{peak} or V_{rms}); minimum distance through insulation (mm)	(see appended table 2.10.5)	—
2.1.1.4	Access to hazardous voltage circuit wiring	No hazardous voltage wiring in operator accessible area.	N/A
2.1.1.5	Energy hazards	The energy does not exceed 240VA between any two points in accessible connector of secondary circuit. (see appended table 2.1.1.5.)	P
2.1.1.6	Manual controls	No manual controls.	N/A
2.1.1.7	Discharge of capacitors in equipment	(See appended table 2.1.1.7)	P
	Measured voltage (V); time-constant (s)	(See appended table 2.1.1.7)	—
2.1.1.8	Energy hazards – d.c. mains supply	a.c. mains supply	N/A
	a) Capacitor connected to the d.c. mains supply ...:		N/A
	b) Internal battery connected to the d.c. mains supply		N/A
2.1.1.9	Audio amplifiers		N/A
2.1.2	Protection in service access areas	No service access area.	N/A
2.1.3	Protection in restricted access locations	Equipment not intended for installation in restricted access locations	N/A

2.2	SELV circuits		P
2.2.1	General requirements	The secondary circuits were tested as SELV. See sub-clauses 2.2.1 to 2.2.4.	P
2.2.2	Voltages under normal conditions (V)	42.4V peak or 60V d.c. are not exceeded in SELV circuit under normal operation.	P

IEC 60950-1			
Clause	Requirement + Test	Result - Remark	Verdict
2.2.3	Voltages under fault conditions (V)	Single fault did not cause excessive voltage in accessible SELV circuits. Limits of 71V peak and 120V d.c. were not exceeded within 0.2 sec. and limits 42.4V peak and 60V d.c. were not exceeded for longer than 0.2 sec., see appended tables 2.2 and 5.3.	P
2.2.4	Connection of SELV circuits to other circuits	See sub-clauses 2.2.2 and 2.2.3. No direct connection between SELV and any primary circuits.	P

2.3	TNV circuits		N/A
2.3.1	Limits		N/A
	Type of TNV circuits		—
2.3.2	Separation from other circuits and from accessible parts		N/A
2.3.2.1	General requirements		N/A
2.3.2.2	Protection by basic insulation		N/A
2.3.2.3	Protection by earthing		N/A
2.3.2.4	Protection by other constructions		N/A
2.3.3	Separation from hazardous voltages		N/A
	Insulation employed		—
2.3.4	Connection of TNV circuits to other circuits		N/A
	Insulation employed		—
2.3.5	Test for operating voltages generated externally		N/A

2.4	Limited current circuits		P
2.4.1	General requirements	Primary and secondary circuits bridged by Y1 type capacitor C913. The pin connected with secondary circuits was disconnected and the measuring instrument of Figure D.1 in Annex D was connected between secondary pin and earth during the test.	P
2.4.2	Limit values	(see appended table 2.4.2)	P

IEC 60950-1			
Clause	Requirement + Test	Result - Remark	Verdict
	Frequency (Hz)		—
	Measured current (mA)		—
	Measured voltage (V)		—
	Measured circuit capacitance (nF or μ F)		—
2.4.3	Connection of limited current circuits to other circuits	Only intended to be connected with SELV circuits	P

2.5	Limited power sources		P
	a) Inherently limited output		N/A
	b) Impedance limited output		N/A
	c) Regulating network limited output under normal operating and single fault condition	<p>For power board 715G7300: Regulation network limits the output of V_{out} in compliance with table 2B, both with and without a simulated single fault in the regulating network.</p> <p>For power board 715G8852: Regulating network limits the output of +19V in compliance with table 2B, both with and without a simulated single fault in the regulating network.</p>	P
	Use of integrated circuit (IC) current limiters		—
	d) Overcurrent protective device limited output		N/A
	Max. output voltage (V), max. output current (A), max. apparent power (VA)		—
	Current rating of overcurrent protective device (A) ..		—
	Use of integrated circuit (IC) current limiters		—

2.6	Provisions for earthing and bonding		P
2.6.1	Protective earthing	Class I appliance inlet terminal provided as protective earthing terminal, and accessible metal plate is connected to earthed metal fire enclosure. The test of 2.6.3.4 complied.	P
2.6.2	Functional earthing	Functional earthing in the secondary circuit is accessible at the VGA connector and separated from the primary by reinforced insulation.	P
	Use of symbol for functional earthing		N/A

IEC 60950-1			
Clause	Requirement + Test	Result - Remark	Verdict
2.6.3	Protective earthing and protective bonding conductors		P
2.6.3.1	General	Appliance inlet used. No power cord provided with the unit.	P
2.6.3.2	Size of protective earthing conductors	AC inlet used	N/A
	Rated current (A), cross-sectional area (mm ²), AWG		—
2.6.3.3	Size of protective bonding conductors	Screws fixing earthed PCB trace to metal chassis for protective bonding.	P
	Rated current (A), cross-sectional area (mm ²), AWG	Refer to test of appended table 2.6.3.4 only.	—
	Protective current rating (A), cross-sectional area (mm ²), AWG	Refer to test of appended table 2.6.3.4 only.	—
2.6.3.4	Resistance of earthing conductors and their terminations; resistance (Ω), voltage drop (V), test current (A), duration (min)	(see appended table 2.6.3.4)	P
2.6.3.5	Colour of insulation	Protective bonding conductor as in 2.6.3 and assembled by printed wiring on power board.	N/A
2.6.4	Terminals	See below	P
2.6.4.1	General		P
2.6.4.2	Protective earthing and bonding terminals	The earth terminal of the approved appliance inlet is considered as protective earthing terminal and was evaluated by sub clause 2.6.3.4.	P
	Rated current (A), type, nominal thread diameter (mm)	Evaluation by test. See sub-clause 2.6.3.4.	—
2.6.4.3	Separation of the protective earthing conductor from protective bonding conductors	Separated PE and protective bonding conductor used.	P
2.6.5	Integrity of protective earthing	See below	P
2.6.5.1	Interconnection of equipment	Not depending on interconnection for protective earthing.	P
2.6.5.2	Components in protective earthing conductors and protective bonding conductors	No switch or overcurrent protective device in protective earthing or bonding conductor	P
2.6.5.3	Disconnection of protective earth	Appliance inlet used for disconnection of protective earth.	P
2.6.5.4	Parts that can be removed by an operator	AC inlet with PE terminal used.	P

IEC 60950-1			
Clause	Requirement + Test	Result - Remark	Verdict
2.6.5.5	Parts removed during servicing		N/A
2.6.5.6	Corrosion resistance	All safety earthing connections comply with Annex J.	P
2.6.5.7	Screws for protective bonding	No self-tapping or spaced thread screws are used. For the earth connection to the metal chassis a spring washer and a screw are used.	N/A
2.6.5.8	Reliance on telecommunication network or cable distribution system	No TNV circuit.	N/A

2.7	Overcurrent and earth fault protection in primary circuits		P
2.7.1	Basic requirements	The equipment relies on fuse or circuit breaker of the wall outlet protection of the building installation in regard to L to N short-circuits. A built-in fuse provided as overcurrent protection device (see 5.3)	P
	Instructions when protection relies on building installation	Pluggable equipment type A.	N/A
2.7.2	Faults not simulated in 5.3.7	The protection devices are well dimensioned and mounted.	P
2.7.3	Short-circuit backup protection	Building installation is considered as providing short-circuit backup protection.	P
2.7.4	Number and location of protective devices :	Overcurrent protection by one built-in fuse	P
2.7.5	Protection by several devices	Protection by one fuse only.	N/A
2.7.6	Warning to service personnel :	No service work necessary.	N/A

2.8	Safety interlocks		N/A
2.8.1	General principles		N/A
2.8.2	Protection requirements		N/A
2.8.3	Inadvertent reactivation		N/A
2.8.4	Fail-safe operation		N/A
	Protection against extreme hazard		N/A
2.8.5	Moving parts		N/A
2.8.6	Overriding		N/A
2.8.7	Switches, relays and their related circuits		N/A

IEC 60950-1			
Clause	Requirement + Test	Result - Remark	Verdict
2.8.7.1	Separation distances for contact gaps and their related circuits (mm)		N/A
2.8.7.2	Overload test		N/A
2.8.7.3	Endurance test		N/A
2.8.7.4	Electric strength test		N/A
2.8.8	Mechanical actuators		N/A

2.9	Electrical insulation		P
2.9.1	Properties of insulating materials	Natural rubber, asbestos or hygroscopic material not used.	P
2.9.2	Humidity conditioning	Performed at 40 °C, 95% R.H. for 120 h by client's request.	P
	Relative humidity (%), temperature (°C)	See above.	—
2.9.3	Grade of insulation	See above.	P
2.9.4	Separation from hazardous voltages	The adequate levels of safety insulation provided and maintained to comply with the requirements of this standard.	P
	Method(s) used	SELV separated from primary by reinforced or double insulation.	—

2.10	Clearances, creepage distances and distances through insulation		P
2.10.1	General	See sub-clauses 2.10.3, 2.10.4 and 2.10.5.	P
2.10.1.1	Frequency	Considered	P
2.10.1.2	Pollution degrees	2	P
2.10.1.3	Reduced values for functional insulation	Considered	P
2.10.1.4	Intervening unconnected conductive parts	Considered	P
2.10.1.5	Insulation with varying dimensions	Insulation kept homogenous.	N/A
2.10.1.6	Special separation requirements	Not applied.	N/A
2.10.1.7	Insulation in circuits generating starting pulses	No such circuits.	N/A
2.10.2	Determination of working voltage		P

IEC 60950-1			
Clause	Requirement + Test	Result - Remark	Verdict
2.10.2.1	General	The rms and the peak voltage were measured with unit connected to a 240V TN power system. The input neutral and secondary ground were connected during measurement. Pollution Degree 2 and Overvoltage Category II considered.	P
2.10.2.2	RMS working voltage	See table 2.10.2	P
2.10.2.3	Peak working voltage	See table 2.10.2	P
2.10.3	Clearances	See below and advantage of annex G is not considered.	P
2.10.3.1	General	Considered.	P
2.10.3.2	Mains transient voltages		P
	a) AC mains supply	240V a.c. and Overvoltage Category II	P
	b) Earthed d.c. mains supplies		N/A
	c) Unearthed d.c. mains supplies		N/A
	d) Battery operation		N/A
2.10.3.3	Clearances in primary circuits	(see appended table 2.10.3 and 2.10.4)	P
2.10.3.4	Clearances in secondary circuits	Sub-clause 5.3.4 considered.	P
2.10.3.5	Clearances in circuits having starting pulses		N/A
2.10.3.6	Transients from a.c. mains supply	Normal transient voltage considered (overvoltage category II for primary circuit).	N/A
2.10.3.7	Transients from d.c. mains supply		N/A
2.10.3.8	Transients from telecommunication networks and cable distribution systems		N/A
2.10.3.9	Measurement of transient voltage levels		N/A
	a) Transients from a mains supply		N/A
	For an a.c. mains supply		N/A
	For a d.c. mains supply		N/A
	b) Transients from a telecommunication network :		N/A
2.10.4	Creepage distances		P
2.10.4.1	General		P
2.10.4.2	Material group and comparative tracking index		P
	CTI tests	Material group IIIb is assumed to be used.	—

IEC 60950-1			
Clause	Requirement + Test	Result - Remark	Verdict
2.10.4.3	Minimum creepage distances	(see appended table 2.10.3 and 2.10.4)	P
2.10.5	Solid insulation		P
2.10.5.1	General		P
2.10.5.2	Distances through insulation	(see appended table 2.10.5)	P
2.10.5.3	Insulating compound as solid insulation	Only inside approved optocoupler.	N/A
2.10.5.4	Semiconductor devices	Approved optocoupler complies to IEC 60747-5-2 and having dti. 0.4mm.	P
2.10.5.5.	Cemented joints	Not applied.	N/A
2.10.5.6	Thin sheet material – General		P
2.10.5.7	Separable thin sheet material	Used in transformer.	P
	Number of layers (pcs)	(see appended table C.2)	—
2.10.5.8	Non-separable thin sheet material	Not applied for.	N/A
2.10.5.9	Thin sheet material – standard test procedure		N/A
	Electric strength test		—
2.10.5.10	Thin sheet material – alternative test procedure		P
	Electric strength test	(see appended table 5.2)	—
2.10.5.11	Insulation in wound components	See only 2.10.5.6.	P
2.10.5.12	Wire in wound components	Approved triple insulation wire provided for secondary windings on transformer T901 of power board 715G8852.	P
	Working voltage	Exceeds 71 V.	P
	a) Basic insulation not under stress		N/A
	b) Basic, supplementary, reinforced insulation	Reinforced.	P
	c) Compliance with Annex U	Approved triple insulated wire used.	P
	Two wires in contact inside wound component; angle between 45° and 90°	Physical separation provided by teflon tube and insulation tape to relieve mechanical stress at the crossover point.	P
2.10.5.13	Wire with solvent-based enamel in wound components	Not applied.	N/A
	Electric strength test		—
	Routine test		N/A
2.10.5.14	Additional insulation in wound components	Not applied.	N/A
	Working voltage		N/A
	- Basic insulation not under stress		N/A

IEC 60950-1			
Clause	Requirement + Test	Result - Remark	Verdict
	- Supplementary, reinforced insulation		N/A
2.10.6	Construction of printed boards		P
2.10.6.1	Uncoated printed boards	(see appended table 2.10.3 and 2.10.4)	P
2.10.6.2	Coated printed boards	Not applied.	N/A
2.10.6.3	Insulation between conductors on the same inner surface of a printed board	Not multi-layer printed board.	N/A
2.10.6.4	Insulation between conductors on different layers of a printed board	See above.	N/A
	Distance through insulation		N/A
	Number of insulation layers (pcs)		N/A
2.10.7	Component external terminations	Coatings not used over terminations to increase effective clearance and creepage distance.	N/A
2.10.8	Tests on coated printed boards and coated components		N/A
2.10.8.1	Sample preparation and preliminary inspection		N/A
2.10.8.2	Thermal conditioning		N/A
2.10.8.3	Electric strength test		N/A
2.10.8.4	Abrasion resistance test		N/A
2.10.9	Thermal cycling		N/A
2.10.10	Test for Pollution Degree 1 environment and insulating compound	Pollution Degree 2.	N/A
2.10.11	Tests for semiconductor devices and cemented joints	Photo couplers are approved components. No other components applied for.	N/A
2.10.12	Enclosed and sealed parts	No hermetically sealed component.	N/A
3	WIRING, CONNECTIONS AND SUPPLY		P
3.1	General		P
3.1.1	Current rating and overcurrent protection	All internal wires are UL approved and PVC insulated. Rated VW-1, min 80°C, 300V. Internal wiring gauge is suitable for current intended to be carried. (See appended table 4.5.1) No internal wire for primary power distribution.	P

IEC 60950-1			
Clause	Requirement + Test	Result - Remark	Verdict
3.1.2	Protection against mechanical damage	Wires do not touch sharp edges which could damage the insulation and cause hazard.	P
3.1.3	Securing of internal wiring	Wires with only basic insulation are routed so that they are not close to any live bare components. Wires are secured by soldering method and additionally fixed by glue or by connectors.	P
3.1.4	Insulation of conductors	The insulation of the individual conductors suitable for the application and the working voltage. For the insulation material see 3.1.1.	P
3.1.5	Beads and ceramic insulators	Not used.	N/A
3.1.6	Screws for electrical contact pressure	Only metal screw is used for electrical connection between protective earth and metal chassis, and engages more than 2 complete threads.	P
3.1.7	Insulating materials in electrical connections	The integrity of protective bonding made by screw, PCB trace and spring washer.	P
3.1.8	Self-tapping and spaced thread screws	No self-tapping or spaced thread screws are used.	N/A
3.1.9	Termination of conductors	All conductors are reliably secured.	P
	10 N pull test		P
3.1.10	Sleeving on wiring	No sleeving used on wiring for supplementary insulation.	N/A

3.2	Connection to a mains supply		P
3.2.1	Means of connection	See below.	P
3.2.1.1	Connection to an a.c. mains supply	Appliance inlet used.	P
3.2.1.2	Connection to a d.c. mains supply	Only a.c. mains supply.	N/A
3.2.2	Multiple supply connections	Only for one mains connection.	N/A
3.2.3	Permanently connected equipment	Unit is not a permanently connected equipment.	N/A
	Number of conductors, diameter of cable and conduits (mm)		—
3.2.4	Appliance inlets	Approved appliance inlet used.	P

IEC 60950-1			
Clause	Requirement + Test	Result - Remark	Verdict
3.2.5	Power supply cords	See below.	N/A
3.2.5.1	AC power supply cords	Not provided.	N/A
	Type		—
	Rated current (A), cross-sectional area (mm ²), AWG		—
3.2.5.2	DC power supply cords	Not provided.	N/A
3.2.6	Cord anchorages and strain relief	Appliance inlet used	N/A
	Mass of equipment (kg), pull (N)		—
	Longitudinal displacement (mm)		—
3.2.7	Protection against mechanical damage		N/A
3.2.8	Cord guards	No cord guards	N/A
	Diameter or minor dimension D (mm); test mass (g)		—
	Radius of curvature of cord (mm).....		—
3.2.9	Supply wiring space	Not permanent connection or non-detachable power cord type.	N/A

3.3	Wiring terminals for connection of external conductors		N/A
3.3.1	Wiring terminals	AC inlet used.	N/A
3.3.2	Connection of non-detachable power supply cords		N/A
3.3.3	Screw terminals		N/A
3.3.4	Conductor sizes to be connected		N/A
	Rated current (A), cord/cable type, cross-sectional area (mm ²).....		—
3.3.5	Wiring terminal sizes		N/A
	Rated current (A), type, nominal thread diameter (mm)		—
3.3.6	Wiring terminal design		N/A
3.3.7	Grouping of wiring terminals		N/A
3.3.8	Stranded wire		N/A

3.4	Disconnection from the mains supply		P
3.4.1	General requirement	Disconnect device provided	P
3.4.2	Disconnect devices	Appliance coupler used as disconnect device.	P
3.4.3	Permanently connected equipment	Not permanently connected equipment	N/A

IEC 60950-1			
Clause	Requirement + Test	Result - Remark	Verdict
3.4.4	Parts which remain energized	When AC coupler is disconnected from inlet, there are no parts remaining with hazardous voltage or energy in the equipment.	P
3.4.5	Switches in flexible cords	No such switch in flexible cords	N/A
3.4.6	Number of poles - single-phase and d.c. equipment	The appliance coupler disconnects both poles simultaneously.	P
3.4.7	Number of poles - three-phase equipment	Single-phase equipment	N/A
3.4.8	Switches as disconnect devices	No such switch	N/A
3.4.9	Plugs as disconnect devices	Plug not used	N/A
3.4.10	Interconnected equipment	Only interconnected with other unit through SELV interface.	P
3.4.11	Multiple power sources	Single power source	N/A

3.5	Interconnection of equipment		P
3.5.1	General requirements	This power supply is not considered for connection to TNV.	P
3.5.2	Types of interconnection circuits	Interconnection circuits of SELV through the connector. No ELV interconnection circuits.	P
3.5.3	ELV circuits as interconnection circuits	No ELV interconnection	N/A
3.5.4	Data ports for additional equipment	All data ports are supplied by LPS.	P

4	PHYSICAL REQUIREMENTS		P
4.1	Stability		P
	Angle of 10°	No overturn.	P
	Test force (N)	Equipment is not a floor standing unit.	N/A

4.2	Mechanical strength		P
4.2.1	General	See below. After tests, unit comply with 2.1.1, 2.6.1 and 2.10.	P
	Rack-mounted equipment.		N/A

IEC 60950-1			
Clause	Requirement + Test	Result - Remark	Verdict
4.2.2	Steady force test, 10 N	Test performed on internal components. No components located such that distances according to 2.10 can be reduced.	P
4.2.3	Steady force test, 30 N	Test performed on internal metal enclosure.	P
4.2.4	Steady force test, 250 N	Test performed on plastic enclosure.	P
4.2.5	Impact test	500g steel ball falls freely from 1.3m on top, back and bottom of plastic enclosure, no access to hazardous parts.	P
	Fall test		P
	Swing test		N/A
4.2.6	Drop test; height (mm) :		N/A
4.2.7	Stress relief test	70°C, 7 hours, no deformation on all sources of plastic enclosure.	P
4.2.8	Cathode ray tubes	No CRT	N/A
	Picture tube separately certified :		N/A
4.2.9	High pressure lamps	No high pressure lamps	N/A
4.2.10	Wall or ceiling mounted equipment; force (N) :		N/A

4.3	Design and construction		P
4.3.1	Edges and corners	Edges and corners of the enclosure are rounded.	P
4.3.2	Handles and manual controls; force (N) :	No safety relevant handles or manual controls.	N/A
4.3.3	Adjustable controls	No such controls.	N/A
4.3.4	Securing of parts	All parts secured properly. Spring washer used for securing screws.	P
4.3.5	Connection by plugs and sockets		N/A
4.3.6	Direct plug-in equipment	Not such equipment.	N/A
	Torque :		—
	Compliance with the relevant mains plug standard :		N/A
4.3.7	Heating elements in earthed equipment	None.	N/A
4.3.8	Batteries	No batteries.	N/A
	- Overcharging of a rechargeable battery		N/A

IEC 60950-1			
Clause	Requirement + Test	Result - Remark	Verdict
	- Unintentional charging of a non-rechargeable battery		N/A
	- Reverse charging of a rechargeable battery		N/A
	- Excessive discharging rate for any battery		N/A
4.3.9	Oil and grease	None.	N/A
4.3.10	Dust, powders, liquids and gases	Equipment in intended use not considered to be exposed to these.	N/A
4.3.11	Containers for liquids or gases	None	N/A
4.3.12	Flammable liquids	None	N/A
	Quantity of liquid (l)		N/A
	Flash point (°C)		N/A
4.3.13	Radiation		P
4.3.13.1	General	See below	P
4.3.13.2	Ionizing radiation	No ionizing radiation.	N/A
	Measured radiation (pA/kg)		—
	Measured high-voltage (kV)		—
	Measured focus voltage (kV)		—
	CRT markings		—
4.3.13.3	Effect of ultraviolet (UV) radiation on materials	No ultraviolet radiation	N/A
	Part, property, retention after test, flammability classification		N/A
4.3.13.4	Human exposure to ultraviolet (UV) radiation	No ultraviolet radiation	N/A
4.3.13.5	Lasers (including laser diodes) and LEDs	See below.	P
4.3.13.5.1	Lasers (including laser diodes)	Not used.	N/A
	Laser class		—
4.3.13.5.2	Light emitting diodes (LEDs)	The following parts are considered complied without tests: Indicating lights; Optocouplers; For LED backlight, the luminance is far less than 10000 cd/m ² . With reference to sub clause 4.1 of IEC 62471:2006 no further test is necessary.	P
4.3.13.6	Other types		N/A
4.4	Protection against hazardous moving parts		N/A

IEC 60950-1			
Clause	Requirement + Test	Result - Remark	Verdict
4.4.1	General		N/A
4.4.2	Protection in operator access areas		N/A
	Household and home/office document/media shredders		N/A
4.4.3	Protection in restricted access locations		N/A
4.4.4	Protection in service access areas		N/A
4.4.5	Protection against moving fan blades		N/A
4.4.5.1	General		N/A
	Not considered to cause pain or injury. a)		N/A
	Is considered to cause pain, not injury. b)		N/A
	Considered to cause injury. c)		N/A
4.4.5.2	Protection for users		N/A
	Use of symbol or warning		N/A
4.4.5.3	Protection for service persons		N/A
	Use of symbol or warning		N/A

4.5	Thermal requirements		P
4.5.1	General		P
4.5.2	Temperature tests		P
	Normal load condition per Annex L	Equipment loaded with rated output current.	—
4.5.3	Temperature limits for materials	(see appended table 4.5)	P
4.5.4	Touch temperature limits	(see appended table 4.5)	P
4.5.5	Resistance to abnormal heat	Bobbin materials of all transformers and some of line chokes are Phenolic that is accepted without further tests. Others see appended table 4.5.5.	P

4.6	Openings in enclosures		P
4.6.1	Top and side openings	(see appended table 4.6.1 and 4.6.2)	P
	Dimensions (mm)		—
4.6.2	Bottoms of fire enclosures	(see appended table 4.6.1 and 4.6.2)	P
	Construction of the bottom, dimensions (mm) ..		—
4.6.3	Doors or covers in fire enclosures	No doors or covers.	N/A
4.6.4	Openings in transportable equipment	Not transportable equipment.	N/A

IEC 60950-1			
Clause	Requirement + Test	Result - Remark	Verdict
4.6.4.1	Constructional design measures		N/A
	Dimensions (mm) :		—
4.6.4.2	Evaluation measures for larger openings		N/A
4.6.4.3	Use of metallized parts		N/A
4.6.5	Adhesives for constructional purposes	The adhesive used to secure mylar sheet on metal enclosure.	P
	Conditioning temperature (°C), time (weeks) :	<p>The tests were performed as below procedure:</p> <ol style="list-style-type: none"> 1. 100°C±2°C for one week 2. Remove from oven and leave at 25°C for 1 h. 3. Place in freezer at -40°C for 4 h. 4. Remove from freezer and allow come to 25°C for 8 h. 5. Place in a compartment at 95% relative humidity for 72 h. 6. Remove and leave at 25°C for 1 h. 7. Place in oven at 100°C for 4 h. 8. Remove and allow sample to reach 25°C over 8 h. <p>For source of adhesive, material, see appended table 1.5.1.</p>	—

4.7	Resistance to fire		P
4.7.1	Reducing the risk of ignition and spread of flame	No excessive temperatures. No easily burning materials employed. Fire enclosure provided. Safety relevant components used within their specified temperature limits.	P
	Method 1, selection and application of components wiring and materials	(see appended table 4.7)	P
	Method 2, application of all of simulated fault condition tests		N/A

IEC 60950-1			
Clause	Requirement + Test	Result - Remark	Verdict
4.7.2	Conditions for a fire enclosure	With having the following parts: - Components in primary; - Components in secondary not supplied by LPS; - Components in secondary supplied by LPS but not mounted on class V-1 or better material; - Insulated wiring. Internal metal enclosure used as fire enclosure.	P
4.7.2.1	Parts requiring a fire enclosure	See above.	P
4.7.2.2	Parts not requiring a fire enclosure	For components in secondary circuits supplied by LPS and mounted on PCB of class V-1 or better material.	P
4.7.3	Materials		P
4.7.3.1	General	PCB rated V-1	P
4.7.3.2	Materials for fire enclosures	Earthed metal enclosure is considered as fire enclosure, which complies without test.	P
4.7.3.3	Materials for components and other parts outside fire enclosures	HB plastic enclosure used, which is outside the fire enclosure.	P
4.7.3.4	Materials for components and other parts inside fire enclosures	Internal components except small parts are V-2, HF-2 or better.	P
4.7.3.5	Materials for air filter assemblies	No air filter.	N/A
4.7.3.6	Materials used in high-voltage components	No such high voltage components in this meaning	N/A

5	ELECTRICAL REQUIREMENTS AND SIMULATED ABNORMAL CONDITIONS		P
5.1	Touch current and protective conductor current		P
5.1.1	General	See sub-clauses 5.1.2 to 5.1.6.	P
5.1.2	Configuration of equipment under test (EUT)	See below.	P
5.1.2.1	Single connection to an a.c. mains supply	EUT has only one mains connection.	P
5.1.2.2	Redundant multiple connections to an a.c. mains supply		N/A
5.1.2.3	Simultaneous multiple connections to an a.c. mains supply		N/A
5.1.3	Test circuit	Using figure 5A.	P

IEC 60950-1			
Clause	Requirement + Test	Result - Remark	Verdict
5.1.4	Application of measuring instrument	Using measuring instrument in annex D.	P
5.1.5	Test procedure		P
5.1.6	Test measurements	(see appended table 5.1.6)	P
	Supply voltage (V)		—
	Measured touch current (mA)		—
	Max. allowed touch current (mA)		—
	Measured protective conductor current (mA)		—
	Max. allowed protective conductor current (mA) ...		—
5.1.7	Equipment with touch current exceeding 3,5 mA	Touch current does not exceed 3.5mA.	N/A
5.1.7.1	General		N/A
5.1.7.2	Simultaneous multiple connections to the supply		N/A
5.1.8	Touch currents to telecommunication networks and cable distribution systems and from telecommunication networks	No TNV circuits.	N/A
5.1.8.1	Limitation of the touch current to a telecommunication network or to a cable distribution system		N/A
	Supply voltage (V)		—
	Measured touch current (mA)		—
	Max. allowed touch current (mA)		—
5.1.8.2	Summation of touch currents from telecommunication networks		N/A
	a) EUT with earthed telecommunication ports		N/A
	b) EUT whose telecommunication ports have no reference to protective earth		N/A
5.2	Electric strength		P
5.2.1	General	(see appended table 5.2)	P
5.2.2	Test procedure	(see appended table 5.2)	P
5.3	Abnormal operating and fault conditions		P
5.3.1	Protection against overload and abnormal operation	Ventilation openings blocked, output of power supply board overloaded, no unaccepted overheating of parts (see appended table 5.3)	P
5.3.2	Motors	Motors not used.	N/A

IEC 60950-1			
Clause	Requirement + Test	Result - Remark	Verdict
5.3.3	Transformers	(see appended Annex C and table 5.3)	P
5.3.4	Functional insulation	By short-circuited, results see appended table 5.3.	P
5.3.5	Electromechanical components	No electromechanical component.	N/A
5.3.6	Audio amplifiers in ITE		N/A
5.3.7	Simulation of faults	(see appended table 5.3.)	P
5.3.8	Unattended equipment	No such equipment.	N/A
5.3.9	Compliance criteria for abnormal operating and fault conditions		P
5.3.9.1	During the tests	No fire or molten metal occurred and no deformation of enclosure during the tests.	P
5.3.9.2	After the tests	No reduction of clearance and creepage distance. Electric strength test is made on basic, supplementary and reinforced insulation after test.	P

6	CONNECTION TO TELECOMMUNICATION NETWORKS		N/A
6.1	Protection of telecommunication network service persons, and users of other equipment connected to the network, from hazards in the equipment		N/A
6.1.1	Protection from hazardous voltages		N/A
6.1.2	Separation of the telecommunication network from earth		N/A
6.1.2.1	Requirements		N/A
	Supply voltage (V)		—
	Current in the test circuit (mA)		—
6.1.2.2	Exclusions		N/A

6.2	Protection of equipment users from overvoltages on telecommunication networks		N/A
6.2.1	Separation requirements		N/A
6.2.2	Electric strength test procedure		N/A
6.2.2.1	Impulse test		N/A
6.2.2.2	Steady-state test		N/A
6.2.2.3	Compliance criteria		N/A

6.3	Protection of the telecommunication wiring system from overheating		N/A
	Max. output current (A)		—

IEC 60950-1			
Clause	Requirement + Test	Result - Remark	Verdict

	Current limiting method		—
--	-------------------------------	--	---

7	CONNECTION TO CABLE DISTRIBUTION SYSTEMS		N/A
7.1	General		N/A
7.2	Protection of cable distribution system service persons, and users of other equipment connected to the system, from hazardous voltages in the equipment		N/A
7.3	Protection of equipment users from overvoltages on the cable distribution system		N/A
7.4	Insulation between primary circuits and cable distribution systems		N/A
7.4.1	General		N/A
7.4.2	Voltage surge test		N/A
7.4.3	Impulse test		N/A

A	ANNEX A, TESTS FOR RESISTANCE TO HEAT AND FIRE		N/A
A.1	Flammability test for fire enclosures of movable equipment having a total mass exceeding 18 kg, and of stationary equipment (see 4.7.3.2)		N/A
A.1.1	Samples.....		—
	Wall thickness (mm)		—
A.1.2	Conditioning of samples; temperature (°C)		N/A
A.1.3	Mounting of samples		N/A
A.1.4	Test flame (see IEC 60695-11-3)		N/A
	Flame A, B, C or D		—
A.1.5	Test procedure		N/A
A.1.6	Compliance criteria		N/A
	Sample 1 burning time (s)		—
	Sample 2 burning time (s)		—
	Sample 3 burning time (s)		—
A.2	Flammability test for fire enclosures of movable equipment having a total mass not exceeding 18 kg, and for material and components located inside fire enclosures (see 4.7.3.2 and 4.7.3.4)		N/A
A.2.1	Samples, material.....		—
	Wall thickness (mm)		—
A.2.2	Conditioning of samples; temperature (°C)		N/A
A.2.3	Mounting of samples		N/A

IEC 60950-1			
Clause	Requirement + Test	Result - Remark	Verdict
A.2.4	Test flame (see IEC 60695-11-4)		N/A
	Flame A, B or C		—
A.2.5	Test procedure		N/A
A.2.6	Compliance criteria		N/A
	Sample 1 burning time (s)		—
	Sample 2 burning time (s)		—
	Sample 3 burning time (s)		—
A.2.7	Alternative test acc. to IEC 60695-11-5, cl. 5 and 9		N/A
	Sample 1 burning time (s)		—
	Sample 2 burning time (s)		—
	Sample 3 burning time (s)		—
A.3	Hot flaming oil test (see 4.6.2)		N/A
A.3.1	Mounting of samples		N/A
A.3.2	Test procedure		N/A
A.3.3	Compliance criterion		N/A

B	ANNEX B, MOTOR TESTS UNDER ABNORMAL CONDITIONS (see 4.7.2.2 and 5.3.2)		N/A
B.1	General requirements		N/A
	Position		—
	Manufacturer		—
	Type		—
	Rated values		—
B.2	Test conditions		N/A
B.3	Maximum temperatures		N/A
B.4	Running overload test		N/A
B.5	Locked-rotor overload test		N/A
	Test duration (days)		—
	Electric strength test: test voltage (V)		—
B.6	Running overload test for d.c. motors in secondary circuits		N/A
B.6.1	General		N/A
B.6.2	Test procedure		N/A
B.6.3	Alternative test procedure		N/A
B.6.4	Electric strength test; test voltage (V)		N/A

IEC 60950-1			
Clause	Requirement + Test	Result - Remark	Verdict
B.7	Locked-rotor overload test for d.c. motors in secondary circuits		N/A
B.7.1	General		N/A
B.7.2	Test procedure		N/A
B.7.3	Alternative test procedure		N/A
B.7.4	Electric strength test; test voltage (V)		N/A
B.8	Test for motors with capacitors		N/A
B.9	Test for three-phase motors		N/A
B.10	Test for series motors		N/A
	Operating voltage (V)		—
C	ANNEX C, TRANSFORMERS (see 1.5.4 and 5.3.3)		P
	Position	See appended table 1.5.1.	—
	Manufacturer	See appended table 1.5.1.	—
	Type	See appended table 1.5.1.	—
	Rated values	See appended table 1.5.1.	—
	Method of protection	By protection circuit.	—
C.1	Overload test	(see appended table 5.3)	P
C.2	Insulation	(see appended table 5.2)	P
	Protection from displacement of windings	Fixed by insulation tape.	P
D	ANNEX D, MEASURING INSTRUMENTS FOR TOUCH-CURRENT TESTS (see 5.1.4)		P
D.1	Measuring instrument		P
D.2	Alternative measuring instrument		N/A
E	ANNEX E, TEMPERATURE RISE OF A WINDING (see 1.4.13)		N/A
F	ANNEX F, MEASUREMENT OF CLEARANCES AND CREEPAGE DISTANCES (see 2.10 and Annex G)		P
G	ANNEX G, ALTERNATIVE METHOD FOR DETERMINING MINIMUM CLEARANCES		N/A
G.1	Clearances		N/A
G.1.1	General		N/A
G.1.2	Summary of the procedure for determining minimum clearances		N/A

IEC 60950-1			
Clause	Requirement + Test	Result - Remark	Verdict
G.2	Determination of mains transient voltage (V)		N/A
G.2.1	AC mains supply		N/A
G.2.2	Earthed d.c. mains supplies		N/A
G.2.3	Unearthed d.c. mains supplies		N/A
G.2.4	Battery operation		N/A
G.3	Determination of telecommunication network transient voltage (V)		N/A
G.4	Determination of required withstand voltage (V)		N/A
G.4.1	Mains transients and internal repetitive peaks		N/A
G.4.2	Transients from telecommunication networks		N/A
G.4.3	Combination of transients		N/A
G.4.4	Transients from cable distribution systems		N/A
G.5	Measurement of transient voltages (V)		N/A
	a) Transients from a mains supply		N/A
	For an a.c. mains supply		N/A
	For a d.c. mains supply		N/A
	b) Transients from a telecommunication network		N/A
G.6	Determination of minimum clearances		N/A
H	ANNEX H, IONIZING RADIATION (see 4.3.13)		N/A
J	ANNEX J, TABLE OF ELECTROCHEMICAL POTENTIALS (see 2.6.5.6)		P
	Metal(s) used	The internal metal enclosure is made of mild steel, screw spring washer are made of Ni on steel, the combined electrochemical potential is below 0.6V according to Table J.1.	—
K	ANNEX K, THERMAL CONTROLS (see 1.5.3 and 5.3.8)		N/A
K.1	Making and breaking capacity		N/A
K.2	Thermostat reliability; operating voltage (V)		N/A
K.3	Thermostat endurance test; operating voltage (V)		N/A
K.4	Temperature limiter endurance; operating voltage (V)		N/A
K.5	Thermal cut-out reliability		N/A
K.6	Stability of operation		N/A

IEC 60950-1			
Clause	Requirement + Test	Result - Remark	Verdict
L	ANNEX L, NORMAL LOAD CONDITIONS FOR SOME TYPES OF ELECTRICAL BUSINESS EQUIPMENT (see 1.2.2.1 and 4.5.2)		P
L.1	Typewriters		N/A
L.2	Adding machines and cash registers		N/A
L.3	Erasers		N/A
L.4	Pencil sharpeners		N/A
L.5	Duplicators and copy machines		N/A
L.6	Motor-operated files		N/A
L.7	Other business equipment	See 1.6.2.	P
M	ANNEX M, CRITERIA FOR TELEPHONE RINGING SIGNALS (see 2.3.1)		N/A
M.1	Introduction		N/A
M.2	Method A		N/A
M.3	Method B		N/A
M.3.1	Ringling signal		N/A
M.3.1.1	Frequency (Hz)		—
M.3.1.2	Voltage (V)		—
M.3.1.3	Cadence; time (s), voltage (V)		—
M.3.1.4	Single fault current (mA)		—
M.3.2	Tripping device and monitoring voltage		N/A
M.3.2.1	Conditions for use of a tripping device or a monitoring voltage		N/A
M.3.2.2	Tripping device		N/A
M.3.2.3	Monitoring voltage (V)		N/A
N	ANNEX N, IMPULSE TEST GENERATORS (see 1.5.7.2, 1.5.7.3, 2.10.3.9, 6.2.2.1, 7.3.2, 7.4.3 and Clause G.5)		N/A
N.1	ITU-T impulse test generators		N/A
N.2	IEC 60065 impulse test generator		N/A
P	ANNEX P, NORMATIVE REFERENCES		—
Q	ANNEX Q, Voltage dependent resistors (VDRs) (see 1.5.9.1)		N/A
	- Preferred climatic categories		N/A
	- Maximum continuous voltage		N/A
	- Combination pulse current		N/A

IEC 60950-1			
Clause	Requirement + Test	Result - Remark	Verdict
	Body of the VDR Test according to IEC60695-11-5		N/A
	Body of the VDR. Flammability class of material (min V-1)		N/A
R	ANNEX R, EXAMPLES OF REQUIREMENTS FOR QUALITY CONTROL PROGRAMMES		N/A
R.1	Minimum separation distances for unpopulated coated printed boards (see 2.10.6.2)		N/A
R.2	Reduced clearances (see 2.10.3)		N/A
S	ANNEX S, PROCEDURE FOR IMPULSE TESTING (see 6.2.2.3)		N/A
S.1	Test equipment		N/A
S.2	Test procedure		N/A
S.3	Examples of waveforms during impulse testing		N/A
T	ANNEX T, GUIDANCE ON PROTECTION AGAINST INGRESS OF WATER (see 1.1.2)		N/A
			—
U	ANNEX U, INSULATED WINDING WIRES FOR USE WITHOUT INTERLEAVED INSULATION (see 2.10.5.4)		P
		Approved triple insulated wire used in main transformer.	—
V	ANNEX V, AC POWER DISTRIBUTION SYSTEMS (see 1.6.1)		P
V.1	Introduction		P
V.2	TN power distribution systems		P
W	ANNEX W, SUMMATION OF TOUCH CURRENTS		N/A
W.1	Touch current from electronic circuits		N/A
W.1.1	Floating circuits		N/A
W.1.2	Earthed circuits		N/A
W.2	Interconnection of several equipments		N/A
W.2.1	Isolation		N/A
W.2.2	Common return, isolated from earth		N/A
W.2.3	Common return, connected to protective earth		N/A

IEC 60950-1			
Clause	Requirement + Test	Result - Remark	Verdict
X	ANNEX X, MAXIMUM HEATING EFFECT IN TRANSFORMER TESTS (see clause C.1)		N/A
X.1	Determination of maximum input current		N/A
X.2	Overload test procedure		N/A
Y	ANNEX Y, ULTRAVIOLET LIGHT CONDITIONING TEST (see 4.3.13.3)		N/A
Y.1	Test apparatus		N/A
Y.2	Mounting of test samples		N/A
Y.3	Carbon-arc light-exposure apparatus		N/A
Y.4	Xenon-arc light exposure apparatus		N/A
Z	ANNEX Z, OVERVOLTAGE CATEGORIES (see 2.10.3.2 and Clause G.2)		P
AA	ANNEX AA, MANDREL TEST (see 2.10.5.8)		N/A
BB	ANNEX BB, CHANGES IN THE SECOND EDITION		—
CC	ANNEX CC, Evaluation of integrated circuit (IC) current limiters		N/A
CC.1	General		N/A
CC.2	Test program 1		N/A
CC.3	Test program 2		N/A
CC.4	Test program 3		N/A
CC.5	Compliance		N/A
DD	ANNEX DD, Requirements for the mounting means of rack-mounted equipment		N/A
DD.1	General		N/A
DD.2	Mechanical strength test, variable N.....		N/A
DD.3	Mechanical strength test, 250 N, including end stops.....		N/A
DD.4	Compliance.....		N/A
EE	ANNEX EE, Household and home/office document/media shredders		N/A
EE.1	General		N/A
EE.2	Markings and instructions		N/A
	Use of markings or symbols.....		N/A

IEC 60950-1			
Clause	Requirement + Test	Result - Remark	Verdict
	Information of user instructions, maintenance and/or servicing instructions.....:		N/A
EE.3	Inadvertent reactivation test.....:		N/A
EE.4	Disconnection of power to hazardous moving parts:		N/A
	Use of markings or symbols.....:		N/A
EE.5	Protection against hazardous moving parts		N/A
	Test with test finger (Figure 2A):		N/A
	Test with wedge probe (Figure EE1 and EE2):		N/A

IEC 60950-1			
Clause	Requirement + Test	Result - Remark	Verdict

1.5.1	TABLE: List of critical components					P
Object/part No.	Manufacturer/ trademark	Type/model	Technical data	Standard (Edition / year)	Mark(s) of conformity ¹⁾	
LCD Panel with LED backlight for 23.8 inch models	L&T	LM238***_**** (* can be 0-9, A-Z or blank for marketing purpose only)	23.8 inch TFT type, with LED back light, power consumption: 12.1W; LED Array Voltage: 38.8V	--	Tested in equipment	
	BOE	MV238***_*** (* can be 0-9, A-Z or blank for marketing purpose only)	23.8 inch TFT type, with LED back light, power consumption: 16.9W; LED Array Voltage: 51.5V	--	Tested in equipment	
	LG Display	LM238WF*_**** (* can be 0-9, A-Z or blank for marketing purpose only)	23.8 inch TFT type, with LED back light, power consumption: 17.76W; LED Array Voltage: 58.9V	--	Tested in equipment	
	TPV	TPM238WF* (* can be 0-9, A-Z or blank for marketing purpose only)	23.8 inch TFT type, with LED back light, power consumption: 15.11W; LED Array Voltage: 52.7V	--	Tested in equipment	
LCD Panel with LED backlight for 27.0 inch models	TPV	TPM270WF*-***** (* can be 0-9, A-Z or blank for marketing purpose only)	27 inch TFT type, with LED back light, power consumption: 21.95W; LED Array Voltage: 65V	--	Tested in equipment	
	CHIMEI INNOLUX	M270HGE-*** (* can be 0-9, A-Z or blank for marketing purpose only)	27 inch TFT type, with LED back light, power consumption: 22.72W; LED Array Voltage: 60V	--	Tested in equipment	
	SAMSUNG	LTM270HP** (* can be 0-9, A-Z or blank for marketing purpose only)	27 inch TFT type, with LED back light, power consumption: 21.3W; LED Array Voltage: 47.0V	--	Tested in equipment	

IEC 60950-1					
Clause	Requirement + Test		Result - Remark		Verdict
	LG Display	LM270WQ* (* can be 0-9, A-Z or blank for marketing purpose only)	27 inch TFT type, with LED back light, power consumption: 24.1W; LED Array Voltage: 54.7V	--	Tested in equipment
	INNOLUX	M270K**-*** (* can be 0-9, A-Z or blank for marketing purpose only)	27 inch TFT type, with LED back light, power consumption: 27.9W; LED Array Voltage: 36.3V	--	Tested in equipment
	L&T	LM270W**-**** (* can be 0-9, A-Z or blank for marketing purpose only)	27 inch TFT type, with LED back light, power consumption: 14.75W; LED Array Voltage: 47.3V	--	Tested in equipment
Plastic Enclosure	LOTTE ADVANCED MATERIALS CO LTD	SD-0150(+), VH-0810(+), VE-0812(+), NH-1000T(+)(&), GC-0700(++)(RR28), GC-0700A(RR), GC-0750(+)(RR70), GC-1017(+)(RR30), VE-1890(+), BF-0675(+), BF-0670(+), NH-1017(p), NH-1017T, NH-1017SG(+), BF-0677(+), HS-7000(+), HG-0760(+), NE-1030(+), HR-1360(+), LX-0951(+), LX-0957(+), TH-1100(+), TN-1100(+)	HB or better, 2.0mm thickness min. 60°C	UL 94	UL (E115797)
	GRAND PACIFIC PETROCHEMICAL CORP	D-150, D-1000, D-1000A	HB or better, 2.0mm thickness min. 60°C	UL 94	UL (E88637)

IEC 60950-1					
Clause	Requirement + Test		Result - Remark		Verdict
	CHI MEI CORPORATION	PA-757(+), PH-88, PA-756S	HB or better, 2.0mm thickness min. 60°C	UL 94	UL (E56070)
	ALBIS PLASTIC GMBH	GP-35, GP-22, 495F	HB or better, 2.0mm thickness min. 60°C	UL 94	UL (E80168)
	COVESTRO DEUTSCHLAND AG [PC RESINS]	FR3000 series, FR3005 series	HB or better, 2.0mm thickness min. 60°C	UL 94	UL (E41613)
	LG CHEM LTD	HF350(#), HF380(m), HF380NS, HF380(#), HF-380(#), HF-380(m), HF-380, HF-380NS, HF380X, AF312T1, AF342T1, LUPOY GN-5001TF(#), GN-5001RFD, LUPOY GN-5008HF(#), LUPOY GP-5008BF(#), SE750(#), XG568(#), XG569(#), GP-1000L, GP-1000F(#), GP-1000(m)(#), LUMILOY GP-1000(#), SE750(#), LUPOY GN-5001RF(T), SE885(#), HF388(#)	HB or better, 2.0mm thickness min. 60°C	UL 94	UL (E171666)
	CHI LIN	GA-1535	HB or better, 2.0mm thickness min. 60°C	UL 94	UL (E177071)

IEC 60950-1					
Clause	Requirement + Test		Result - Remark	Verdict	
	KINGFA SCI & TECH CO LTD	4418, 5197, FRABS-518, HIPS-5197, HF-606, HF-626, FRABS-518, GAR-011C, JH960 6(M), FRHIPS-960, RS-900, RS-300, RS-400, GAR-011, GAR-011(L65), GAR-011(L85), GAR-011(HG6), CK-100, CK-900, CK-55111, JH960 6(M), FRHIPS-960, HIPS-4418, HIPS-3399, HIPS-CM(ee), HIPS-HG(ee), HIPS-510 (o), HIPS-550, CK-61(M) (##), RS-(hh)0, HP-126, ABS-660, ABS-122, GAR-322, GAR-332, GAR-220, H12, G360, CK-55(M) (##), CK-58(M) (##), GAR-011C, GAR-011(ww)	HB or better, 2.0mm thickness min. 60°C	UL 94	UL (E230779)
	QINGDAO HAIER NEW MATERIAL R & D CO LTD	HRABS-RS, HRABS-HG, CR-3002	HB or better, 2.0mm thickness min. 60°C	UL 94	UL (E328304)
	DONGGUAN HINGLONG PLASTIC TECHNOLOGY CO LTD	HL-ABS-PCR85, HL-ABS-PCR65, HL-ABS-PCR35	HB or better, 2.0mm thickness min. 60°C	UL 94	UL (E471190)

IEC 60950-1					
Clause	Requirement + Test		Result - Remark		Verdict
	ORINKO (HEFEI) ADVANCED PLASTIC CO LTD	ABS-3070H, HIPS-2000	HB or better, 2.0mm thickness min. 60°C	UL 94	UL (E471190)
	WISTRON ADVANCED MATERIALS (KUNSHAN) CO LTD	GA(M)(b)(c)	HB or better, 2.0mm thickness min. 60°C	UL 94	UL (E310240)
	UNIC TECHNOLOGY CORP	UR- 3006+(RXX), UR-200+	HB or better, 2.0mm thickness min. 60°C	UL 94	UL (E135175)
	GUO HENG (DONGGUAN)	YOUHO(####)(Y)	HB or better, 2.0mm thickness min. 60°C	UL 94	UL (E471190)
	HUIZHOU WOTE	2100	HB or better, 2.0mm thickness min. 60°C	UL 94	UL (E135175)
	TEIJIN LIMITED RESIN AND PLASTIC	TN-7500(c), TN-7500F(#), MN-3600V(#), MN-3600H(#)	HB or better, 2.0mm thickness min. 60°C	UL 94	UL (E98529)
	INEOS STYROLUTION GROUP GMBH	495F GR2, 495F KG2, 495F GR21, 495F KG21, PC2065	HB or better, 2.0mm thickness min. 60°C	UL 94	UL (E108538)
	STYRON	STYRON A- TECH 1200	HB or better, 2.0mm thickness min. 60°C	UL 94	UL (E162447)
	TOTAL PETROCHEMIC ALS SOUTH EAST ASIA PTE LTD	3441; 260-XX	HB or better, 2.0mm thickness min. 60°C	UL 94	UL (E314268)
	DOOSAN CORPORATION ELECTRO- MATERIALS BG	DS-1107A; DS-1202G; DS-7106	HB or better, 2.0mm thickness min. 60°C	UL 94	UL (E103670)
	SABIC JAPAN L L C	C6600(GG)(X)(V S), C6600E (VS)(X)	HB or better, 2.0mm thickness min. 60°C	UL 94	UL (E207780)
Base stand	Interchangeable	Interchangeable	HB or better	UL 94	UL

IEC 60950-1					
Clause	Requirement + Test			Result - Remark	Verdict
Metal enclosure (except part under power board)	Interchangeable	Interchangeable	Metal thickness: min. 0.6mm	--	--
Metal enclosure (under power board)	Interchangeable	Interchangeable	Metal thickness: min. 0.81mm	--	--
PCB	Interchangeable	Interchangeable	V-1 or better, min. 105°C, thickness: 1.50mm	UL 94	UL
Mylar sheet between power board and panel plate	SUZHOU OMA Y OPTICAL MATERIALS CO LTD	SE42B, SE42B-F	min. 0.4mm thickness, min. V-1, 105°C	UL 94	UL
	SICHUAN LONGHUA FILM CO LTD	PC-770F, PC-770F-A, PC-770	min. 0.4mm thickness, min. V-1, 105°C	UL 94	UL
	SICHUAN DONGFANG INSULATING MATERIAL CO LTD	DFR700, DFR700F	min. 0.4mm thickness, min. V-1, 105°C	UL 94	UL
	CHENGDU KANGLONGXIN PLASTICS CO LTD	KLX FRPC-1860B, KLX FRPC-1870B	min. 0.4mm thickness, min. V-1, 105°C	UL 94	UL
	CHENGDU KANGLONGXIN PLASTICS CO LTD	KLX FRPC-870B	min. 0.4mm thickness, min. V-1, 105°C	UL 94	UL
	SICHUAN DONGFANG INSULATING MATERIAL CO LTD	DFR117ECOC, DFR117ECOB	min. 0.4mm thickness, min. V-1, 105°C	UL 94	UL
	SICHUAN DONGFANG INSULATING MATERIAL CO LTD	DFR117ECO	min. 0.4mm thickness, min. V-1, 105°C	UL 94	UL
	JINGMEN GORUN TECHNOLOGY CO LTD	HF70	min. 0.4mm thickness, min. V-1, 105°C	UL 94	UL

IEC 60950-1					
Clause	Requirement + Test			Result - Remark	Verdict
	SICHUAN DONGFANG INSULATING MATERIAL CO LTD	DFR3A(d)	min. 0.4mm thickness, min. V-1, 105°C	UL 94	UL
	CHENGDU KANGLONGXIN PLASTICS CO LTD	KLX PP BK-10	min. 0.4mm thickness, min. V-1, 105°C	UL 94	UL
Mylar sheet (used to cover the right side opening of metal enclosure)	Interchangeable	Interchangeable	V-0 or better, 105°C, adhered to metal enclosure by below adhesive or glue	--	UL
Adhesive of Mylar sheet	Ningbo Fenghua	RF-0345	Thickness 0.05mm	--	--
	SYMBIL	DS50-A DS50L	Thickness 0.05mm	--	--
Speaker (2 sets) (optional)	Interchangeable	Interchangeable	Max. 8Ω, max. 4.5 W	--	--
Power supply with DC/DC converter circuit: 715G7300					
AC-Inlet (CN901)	Solteam	ST-01	10A, 250Vac	IEC/ EN 60320-1 UL60320-1	VDE, UL
	Zhang Jia Gang-Hua Jie	SA-4S, SA-4S-1, SA-4D	10A, 250Vac	IEC/ EN 60320-1 UL60320-1	VDE, UL
	Rong Feng	SS-120, SS-7B	10A, 250Vac	IEC/ EN 60320-1 UL60320-1	VDE, UL
	Inalways	0707-1, 0711-2, 0714	10A, 250Vac	IEC/ EN 60320-1 UL60320-1	VDE, UL
	DELIKANG	CDJ-3, CDJ-3-1	10A, 250Vac	IEC/ EN 60320-1 UL60320-1	VDE, UL
	TECX	TU-301 series	10A, 250Vac	IEC/ EN 60320-1 UL60320-1	VDE, UL
	Yueqing Hongchang	DB-14	10A, 250Vac	IEC/ EN 60320-1 UL60320-1	VDE, UL
Fuse (F901)	Littelfuse, Inc. Wickmann	382-series, 392	T3.15AL, 250Vac	IEC/ EN 60127-1 IEC/ EN 60127-3 UL 248-1	VDE, UL
	Littelfuse Phils. Inc.	TE5 400 series	T3.15AL, 250Vac	IEC/ EN 60127-1 IEC/ EN 60127-3	VDE
	Conquer	MET series, MST series, PTU	T3.15AL, 250Vac	IEC/ EN 60127-1 IEC/ EN 60127-3 UL 248-1	VDE, UL

IEC 60950-1					
Clause	Requirement + Test		Result - Remark		Verdict
	Cooper Bussmann	SR-5, SS-5	T3.15AL, 250Vac	IEC/ EN 60127-1 IEC/ EN 60127-3 UL 248-1	VDE, UL
	Ever Island Electric Co., Ltd. & Walter Electric	2000, 2010 series	T3.15AL, 250Vac	IEC/ EN 60127-1 IEC/ EN 60127-3 UL 248-1	VDE, UL
	Littelfuse Phils. Inc.	877	T3.15AL, 250Vac	IEC/ EN 60127-1 IEC/ EN 60127-3 UL 248-1	VDE, UL
Y- Capacitor (C902, C903) Y1 or Y2 type (optional)	Walsin	AC, AH	Max. 1000pF, 250Vac, 85°C	IEC/EN 60384-14 UL 60384-14	VDE, UL
	TDK	CS, CD	Max. 1000pF, 250Vac, 85°C	IEC/EN 60384-14 UL 60384-14	VDE, UL
	Murata	KH, KX	Max. 1000pF, 250Vac, 85°C	IEC/EN 60384-14 UL 60384-14	VDE, UL
	JYA-NAY	JY, JN	Max. 1000pF, 250Vac, 85°C	IEC/EN 60384-14 UL 60384-14	VDE, UL
	Hongming	F	Max. 1000pF, 250Vac, 85°C	IEC/EN 60384-14 UL 60384-14	VDE, UL
	Wansheng	CT7	Max. 1000pF, 250Vac, 85°C	IEC/EN 60384-14 UL 60384-14	VDE, UL
	Haohua	CT7	Max. 1000pF, 250Vac, 85°C	IEC/EN 60384-14 UL 60384-14	VDE, UL
	Samwha	SD	Max. 1000pF, 250Vac, 85°C	IEC/EN 60384-14 UL 60384-14	VDE, UL
	Matsushita	NS-A, NS-B	Max. 1000pF, 250Vac, 85°C	IEC/EN 60384-14 UL 60384-14	VDE, UL
	Success	SB, SE	Max. 1000pF, 250Vac, 85°C	IEC/EN 60384-14 UL 60384-14	VDE, UL
	Yinan Don's	CT81	Max. 1000pF, 250Vac, 85°C	IEC/EN 60384-14 UL 60384-14	VDE, UL

IEC 60950-1					
Clause	Requirement + Test			Result - Remark	Verdict
Y- Capacitor (C913) Y1 type (optional)	Walsin	AH	Max. 1000pF, 250Vac, 85°C	IEC/EN 60384-14 UL 60384-14	VDE, UL
	TDK	CD	Max. 1000pF, 250Vac, 85°C	IEC/EN 60384-14 UL 60384-14	VDE, UL
	Murata	KX	Max. 1000pF, 250Vac, 85°C	IEC/EN 60384-14 UL 60384-14	VDE, UL
	JYA-NAY	JN	Max. 1000pF, 250Vac, 85°C	IEC/EN 60384-14 UL 60384-14	VDE, UL
	Hongming	F	Max. 1000pF, 250Vac, 85°C	IEC/EN 60384-14 UL 60384-14	VDE, UL
	Wansheng	CT7	Max. 1000pF, 250Vac, 85°C	IEC/EN 60384-14 UL 60384-14	VDE, UL
	Haohua	CT7	Max. 1000pF, 250Vac, 85°C	IEC/EN 60384-14 UL 60384-14	VDE, UL
	Samwha	SD	Max. 1000pF, 250Vac, 85°C	IEC/EN 60384-14 UL 60384-14	VDE, UL
	Matsushita	NS-A	Max. 1000pF, 250Vac, 85°C	IEC/EN 60384-14 UL 60384-14	VDE, UL
	Success	SB, SE	Max. 1000pF, 250Vac, 85°C	IEC/EN 60384-14 UL 60384-14	VDE, UL
	Yinan Don's	CT81	Max. 1000pF, 250Vac, 85°C	IEC/EN 60384-14 UL 60384-14	VDE, UL
X-Capacitor (X1 or X2 type) (C901) (optional)	Ultra Tech Xiphi	HQX	Max. 0.22μF, Min. 250Vac, 85°C	IEC/EN 60384-14 UL 60384-14	VDE, UL
	Faratronic	MKP62	Max. 0.22μF, Min. 250Vac, 85°C	IEC/EN 60384-14 UL 60384-14	VDE, UL
	Hua Jung	MKP	Max. 0.22μF, Min. 250Vac, 85°C	IEC/EN 60384-14 UL 60384-14	ENEC(Sem ko), UL
	Nanjing Tengen Rongguangda	MKP	Max. 0.22μF, Min. 250Vac, 85°C	IEC/EN 60384-14 UL 60384-14	VDE, UL

IEC 60950-1					
Clause	Requirement + Test			Result - Remark	Verdict
	Europtronic	MPX, MPX2	Max. 0.22 μ F, Min. 250Vac, 85°C	IEC/EN 60384-14 UL 60384-14	VDE, UL
	Liow Gu	GS-L	Max. 0.22 μ F, Min. 250Vac, 85°C	IEC/EN 60384-14 UL 60384-14	VDE, UL
	Arcotronics (KEMET)	R.46	Max. 0.22 μ F, Min. 250Vac, 85°C	IEC/EN 60384-14 UL 60384-14	ENEC(IMQ), UL
	EPCOS	B3292#	Max. 0.22 μ F, Min. 250Vac, 85°C	IEC/EN 60384-14 UL 60384-14	VDE, UL
	ZhuHai Sung Ho Electronics Co., Ltd.	CMPP	Max. 0.22 μ F, Min. 250Vac, 85°C	IEC/EN 60384-14 UL 60384-14	VDE, UL
Photo Coupler (U902)	Sharp	PC123	Di=0.7mm, int. cr=thermal cycling ³ , ext. cr=8.0mm, min.3000Vac, 100°C	DIN EN 60747-5-2, UL1577	VDE, UL, Semko, Nemko, Fimko
	Vishay Semiconductor	TCET1103	Di=0.6mm, int. cr=thermal cycling ³ , ext. cr=8.4mm, min.3000Vac, 100°C	DIN EN 60747-5-2, UL1577	VDE, UL, Semko, Fimko
	Everlight Electronics Co., Ltd.	EL817, EL817M	Di=0.5mm, int. cr=6.0mm, ext. cr=7.7mm, min.3000Vac, 100°C	DIN EN 60747-5-2, UL1577	VDE, UL, Semko, Nemko, Fimko
	Everlight Electronics Co., Ltd.	EL1013	Di=0.4mm, int. cr=thermal cycling ³ , ext. cr=8.0mm, min.3000Vac, 100°C	DIN EN 60747-5-2, UL1577	VDE, UL, Semko
	Lite-on	LTV-817	Di=0.4mm, int. cr=thermal cycling ³ , ext. cr=8.0mm, min.3000Vac, 100°C	DIN EN 60747-5-2, UL1577	VDE, UL
	Renesas	PS2561-1 PS2561L-1 PS2561L1-1 PS2561L2-1 PS2561DL1-1	Di=0.4mm, int. cr=thermal cycling ³ , ext. cr=8.0mm, min.3000Vac, 100°C	DIN EN 60747-5-2, UL1577	VDE, UL, Nemko, Fimko

IEC 60950-1					
Clause	Requirement + Test		Result - Remark		Verdict
	TOSHIBA	TLP781F TLP781 TLP421F	Di=0.4mm, int. cr=thermal cycling ³ . ext. cr=8.0mm, min.3000Vac, 100°C	DIN EN 60747-5- 2, UL1577	VDE, UL, Semko, Fimko
Thermistor (NR901)	Interchangeable	Interchangeable	Min. 3Ω at 25°C, min. 2A	--	--
Bleeder Resistor (R907, R908, R909)	Interchangeable	Interchangeable	Max. 1MΩ, min. 1/4W	--	--
Current sensor resistor (R931)	Interchangeable	Interchangeable	Min. 0.68Ω, 2W	--	--
Bridging Diode (BD901)	Interchangeable	Interchangeable	Min.500V, min.2A	--	--
Ripple Capacitor (C907)	Interchangeable	Interchangeable	50-150μF, max. 450V, 105°C	--	--
Transistor (Q901)	Interchangeable	Interchangeable	Min.500V, min.2A	--	--
Line Choke (L901) (optional)	TAICHANG	73G-174-192-S	105°C	--	--
	ASET	073G174192X	105°C	--	--
	DADON	73G-174-192-H	105°C	--	--
	FRONTIER	73G-174-192-F	105°C	--	--
	LI TAI	73G-174-192-L	105°C	--	--
	YUVA	73G-174-192-N	105°C	--	--
	DARFON	73G-174-192- DN	105°C	--	--
Transformer (T901) (Alt.)	Li Tai	380GL19P533L	Class 130 material (B)	Applicable parts of IEC 60950-1 and according to IEC 60085	Accepted by TÜV Rheinland
Bobbin	Sumitomo	PM-9820	V-0, Phenolic, 150°C	UL 94	UL
Margin tape	SYMBIO INC	No.35661\$	130°C	UL510	UL
Insulation Tape	3M	No.44(a)	130°C	UL510	UL
	SYMBIO INC	No.35660Y*(%)	130°C	UL510	UL
Transformer (T901) (Alt.)	JINGJIANG	No.CT(c)	130°C	UL510	UL
	YUVA	380GL19P533N	Class 130 material (B)	Applicable parts of IEC 60950-1 and according to IEC 60085	Accepted by TÜV Rheinland
Bobbin	Sumitomo	PM-9820	V-0, Phenolic, 150°C	UL 94	UL

IEC 60950-1					
Clause	Requirement + Test			Result - Remark	Verdict
Margin tape	SYMBIO INC	No.35661\$	130°C	UL510	UL
	3M	No.44(a)	130°C	UL510	UL
Insulation Tape	SYMBIO INC	No.35660Y*(%)	130°C	UL510	UL
	JINGJIANG YAHUA	No.CT(c)	130°C	UL510	UL
Transformer (T901) (Alt.)	TPV	S80GL19P533V	Class 130 material (B)	Applicable parts of IEC 60950-1 and according to IEC 60085	Accepted by TÜV Rheinland
Bobbin	Sumitomo	PM-9820	V-0, Phenolic, 150°C	UL 94	UL
Margin tape	SYMBIO INC	No.35661\$	130°C	UL510	UL
	JINGJIANG YAHUA	No.WF(c)	130°C	UL510	UL
Insulation Tape	JINGJIANG YAHUA	No.CT(c)	130°C	UL510	UL
	SYMBIO INC	No.35660Y*(%)	130°C	UL510	UL
Transformer (T901) (Alt.)	LFDJ	380GL19P533J	Class 130 material (B)	Applicable parts of IEC 60950-1 and according to IEC 60085	Accepted by TÜV Rheinland
Bobbin	Sumitomo	PM-9820	V-0, Phenolic, 150°C	UL 94	UL
Margin tape	SYMBIO INC	No.35661\$	130°C	UL510	UL
	3M	No.44(a)	130°C	UL510	UL
Insulation Tape	JINGJIANG YAHUA	No.CT(c)	130°C	UL510	UL
Transformer (T901) (Alt.)	PHOENIX	380GL19P533P	Class 130 material (B)	Applicable parts of IEC 60950-1 and according to IEC 60085	Accepted by TÜV Rheinland
Bobbin	Sumitomo	PM-9820	V-0, Phenolic, 150°C	UL 94	UL
Margin tape	JINGJIANG YAHUA	No.WF(c)	130°C	UL510	UL
Insulation Tape	JINGJIANG YAHUA	No.CT(c)	130°C	UL510	UL
Transformer (T901) Alt.)	Channelon	380GL19P533H	Class 130 material (B)	Applicable parts of IEC 60950-1 and according to IEC 60085	Accepted by TÜV Rheinland
- Bobbin	Sumitomo	PM-9820	V-0, Phenolic, 150°C	UL 94	UL
- Margin tape	SYMBIO INC	No.35661\$	130°C	UL510	UL
- Insulation Tape	JINGJIANG YAHUA	No.CT(c)	130°C	UL510	UL

IEC 60950-1					
Clause	Requirement + Test			Result - Remark	Verdict
	SYMBIO INC	No.35660Y*(%)	130°C	UL510	UL
Transformer (T901) Alt.)	Taichang	380GL19P533S	Class 130 material (B)	Applicable parts of IEC 60950-1 and according to IEC 60085	Accepted by TÜV Rheinland
- Bobbin	Sumitomo	PM-9820	V-0, Phenolic, 150°C	UL 94	UL
- Margin tape	JINGJIANG YAHUA	No.WF(c)	130°C	UL510	UL
- Insulation Tape	JINGJIANG YAHUA	No.CT(c)	130°C	UL510	UL
Power supply with DC/DC converter circuit: 715G8852					
Power switch (SW901) (optional)	Rong Feng	RF-1003	10A, 250Vac	IEC 61058-1, UL 1054	VDE, UL
	Solteam Electronics Co Ltd	Series MR-21	10A, 250Vac	IEC 61058-1, UL 1054	ENEC, UL
	Solteam Electronics Co Ltd	MR-21S	ENEC: 6A, 250V, UL:10A, 125/250Vac	IEC 61058-1, UL 1054	ENEC, UL
	Solteam Electronics Co Ltd	OR-L, OR-P	ENEC: 6A, 250V, UL: 10A/125Vac, 6A/250Vac	IEC 61058-1, UL 1054	ENEC, UL
	Solteam Electronics Co Ltd	MR-22	ENEC: 12(4)A, 250V, UL:12A, 125/250Vac	IEC 61058-1, UL 1054	ENEC, UL
	Chily	3024 series	Nemko: 16(4)A, 250Vac, UL: 15A, 250Vac	IEC 61058-1, UL 1054	Nemko, UL
	Zhangjiagang Huajie Electronic Co.,Ltd	PS8	VDE: 6(4)A, 250Vac; 10A, 125Vac UL: 6 (4)A, 125/250Vac	IEC 61058-1, UL 1054	VDE, UL
	YUEQING HONGCHANG RADIO CO LTD	RS series RT Series	ENEC: 6A, 250V, UL: 10A/125Vac, 6A/250Vac	IEC 61058-1, UL 1054	ENEC, UL
AC-Inlet (CN901)	Solteam	ST-01	10A, 250Vac	IEC/ EN 60320-1 UL60320-1	VDE, UL
	Zhang Jia Gang-Hua Jie	SA-4S, SA-4S-1, SA-4D	10A, 250Vac	IEC/ EN 60320-1 UL60320-1	VDE, UL
	Rong Feng	SS-120, SS-7B	10A, 250Vac	IEC/ EN 60320-1 UL60320-1	VDE, UL
	Inalways	0707-1, 0711-2, 0714	10A, 250Vac	IEC/ EN 60320-1 UL60320-1	VDE, UL

IEC 60950-1					
Clause	Requirement + Test			Result - Remark	Verdict
	DELIKANG	CDJ-3, CDJ-3-1	10A, 250Vac	IEC/ EN 60320-1 UL60320-1	VDE, UL
	TECX	TU-301 series	10A, 250Vac	IEC/ EN 60320-1 UL60320-1	VDE, UL
	Yueqing Hongchang	DB-14	10A, 250Vac	IEC/ EN 60320-1 UL60320-1	VDE, UL
Fuse (F901)	Littelfuse, Inc. Wickmann	382-series, 392	T4AL, 250Vac	IEC/ EN 60127-1 IEC/ EN 60127-3 UL 248-1	VDE, UL
	Littelfuse Phils. Inc.	TE5 400 series	T4AL, 250Vac	IEC/ EN 60127-1 IEC/ EN 60127-3 UL 248-1	VDE
	Conquer	MET series, MST series, PTU	T4AL, 250Vac	IEC/ EN 60127-1 IEC/ EN 60127-3 UL 248-1	VDE, UL
	Cooper Bussmann	SR-5, SS-5	T4AL, 250Vac	IEC/ EN 60127-1 IEC/ EN 60127-3 UL 248-1	VDE, UL
	Ever Island Electric Co., Ltd. & Walter Electric	2000, 2010 series	T4AL, 250Vac	IEC/ EN 60127-1 IEC/ EN 60127-3 UL 248-1	VDE, UL
	Littelfuse Phils. Inc.	877	T4AL, 250Vac	IEC/ EN 60127-1 IEC/ EN 60127-3 UL 248-1	VDE, UL
Y- Capacitor (C902, C901) Y1 or Y2 type (optional)	Walsin	AC, AH	Max. 3300pF, 250Vac, 85°C	IEC/EN 60384- 14 UL 60384-14	VDE, UL
	TDK	CS, CD	Max. 3300pF, 250Vac, 85°C	IEC/EN 60384- 14 UL 60384-14	VDE, UL
	Murata	KH, KX	Max. 3300pF, 250Vac, 85°C	IEC/EN 60384- 14 UL 60384-14	VDE, UL
	JYA-NAY	JY, JN	Max. 3300pF, 250Vac, 85°C	IEC/EN 60384- 14 UL 60384-14	VDE, UL
	Hongming	F	Max. 3300pF, 250Vac, 85°C	IEC/EN 60384- 14 UL 60384-14	VDE, UL
	Wansheng	CT7	Max. 3300pF, 250Vac, 85°C	IEC/EN 60384- 14 UL 60384-14	VDE, UL
	Haohua	CT7	Max. 3300pF, 250Vac, 85°C	IEC/EN 60384- 14 UL 60384-14	VDE, UL

IEC 60950-1					
Clause	Requirement + Test			Result - Remark	Verdict
	Samwha	SD	Max. 3300pF, 250Vac, 85°C	IEC/EN 60384-14 UL 60384-14	VDE, UL
	Matsushita	NS-A, NS-B	Max. 3300pF, 250Vac, 85°C	IEC/EN 60384-14 UL 60384-14	VDE, UL
	Success	SB, SE	Max. 3300pF, 250Vac, 85°C	IEC/EN 60384-14 UL 60384-14	VDE, UL
	Yinan Don's	CT81	Max. 3300pF, 250Vac, 85°C	IEC/EN 60384-14 UL 60384-14	VDE, UL
Y- Capacitor (C913) Y1 type (optional)	Walsin	AH	Max. 2200pF, 250Vac, 85°C	IEC/EN 60384-14 UL 60384-14	VDE, UL
	TDK	CD	Max. 2200pF, 250Vac, 85°C	IEC/EN 60384-14 UL 60384-14	VDE, UL
	Murata	KX	Max. 2200pF, 250Vac, 85°C	IEC/EN 60384-14 UL 60384-14	VDE, UL
	JYA-NAY	JN	Max. 2200pF, 250Vac, 85°C	IEC/EN 60384-14 UL 60384-14	VDE, UL
	Hongming	F	Max. 2200pF, 250Vac, 85°C	IEC/EN 60384-14 UL 60384-14	VDE, UL
	Wansheng	CT7	Max. 2200pF, 250Vac, 85°C	IEC/EN 60384-14 UL 60384-14	VDE, UL
	Haohua	CT7	Max. 2200pF, 250Vac, 85°C	IEC/EN 60384-14 UL 60384-14	VDE, UL
	Samwha	SD	Max. 2200pF, 250Vac, 85°C	IEC/EN 60384-14 UL 60384-14	VDE, UL
	Matsushita	NS-A	Max. 2200pF, 250Vac, 85°C	IEC/EN 60384-14 UL 60384-14	VDE, UL
	Success	SB, SE	Max. 2200pF, 250Vac, 85°C	IEC/EN 60384-14 UL 60384-14	VDE, UL
	Yinan Don's	CT81	Max. 2200pF, 250Vac, 85°C	IEC/EN 60384-14 UL 60384-14	VDE, UL

IEC 60950-1					
Clause	Requirement + Test			Result - Remark	Verdict
X-Capacitor (X1 or X2 type) (C922, C903) (optional)	Ultra Tech Xiphi	HQX	Max. 0.22 μ F, Min. 250Vac, 85°C	IEC/EN 60384-14 UL 60384-14	VDE, UL
	Faratronic	MKP62	Max. 0.22 μ F, Min. 250Vac, 85°C	IEC/EN 60384-14 UL 60384-14	VDE, UL
	Hua Jung	MKP	Max. 0.22 μ F, Min. 250Vac, 85°C	IEC/EN 60384-14 UL 60384-14	ENEC(Semko), UL
	Nanjing Tengen Rongguangda	MKP	Max. 0.22 μ F, Min. 250Vac, 85°C	IEC/EN 60384-14 UL 60384-14	VDE, UL
	Europtronic	MPX, MPX2	Max. 0.22 μ F, Min. 250Vac, 85°C	IEC/EN 60384-14 UL 60384-14	VDE, UL
	Liow Gu	GS-L	Max. 0.22 μ F, Min. 250Vac, 85°C	IEC/EN 60384-14 UL 60384-14	VDE, UL
	Arcotronics (KEMET)	R.46	Max. 0.22 μ F, Min. 250Vac, 85°C	IEC/EN 60384-14 UL 60384-14	ENEC(IMQ), UL
	EPCOS	B3292#	Max. 0.22 μ F, Min. 250Vac, 85°C	IEC/EN 60384-14 UL 60384-14	VDE, UL
	ZhuHai Sung Ho Electronics Co., Ltd.	CMPP	Max. 0.22 μ F, Min. 250Vac, 85°C	IEC/EN 60384-14 UL 60384-14	VDE, UL
Photo Coupler (U902)	Sharp	PC123	Di=0.7mm, int. cr=thermal cycling ³ , ext. cr=8.0mm, min.3000Vac, 100°C	DIN EN 60747-5-2, UL1577	VDE, UL, Semko, Nemko, Fimko
	Vishay Semiconductor	TCET1103	Di=0.6mm, int. cr=thermal cycling ³ , ext. cr=8.4mm, min.3000Vac, 100°C	DIN EN 60747-5-2, UL1577	VDE, UL, Semko, Fimko
	Everlight Electronics Co., Ltd.	EL817, EL817M	Di=0.5mm, int. cr=6.0mm, ext. cr=7.7mm, min.3000Vac, 100°C	DIN EN 60747-5-2, UL1577	VDE, UL, Semko, Nemko, Fimko
	Everlight Electronics Co., Ltd.	EL1013	Di=0.4mm, int. cr=thermal cycling ³ , ext. cr=8.0mm, min.3000Vac, 100°C	DIN EN 60747-5-2, UL1577	VDE, UL, Semko

IEC 60950-1					
Clause	Requirement + Test		Result - Remark		Verdict
	Lite-on	LTV-817	Di=0.4mm, int. cr=thermal cycling ³ . ext. cr=8.0mm, min.3000Vac, 100°C	DIN EN 60747-5- 2, UL1577	VDE, UL
	Renesas	PS2561-1 PS2561L-1 PS2561L1-1 PS2561L2-1 PS2561DL1-1	Di=0.4mm, int. cr=thermal cycling ³ . ext. cr=8.0mm, min.3000Vac, 100°C	DIN EN 60747-5- 2, UL1577	VDE, UL, Nemko, Fimko
	TOSHIBA	TLP781F TLP781 TLP421F	Di=0.4mm, int. cr=thermal cycling ³ . ext. cr=8.0mm, min.3000Vac, 100°C	DIN EN 60747-5- 2, UL1577	VDE, UL, Semko, Fimko
Thermistor (NR901)	Interchangeable	Interchangeable	Min. 0.2Ω at 25°C, min. 2A	--	--
Bleeder Resistor (R907, R908, R909)	Interchangeable	Interchangeable	Max. 1MΩ, min. 1/4W	--	--
Current sensor resistor (R916)	Interchangeable	Interchangeable	Min. 0.33Ω, 2W	--	--
Bridging Diode (BD901, BD902) (Optional)	Interchangeable	Interchangeable	Min.500V, min.2A	--	--
Ripple Capacitor (C904)	Interchangeable	Interchangeable	45-150μF, max. 450V, 105°C	--	--
Transistor (Q901)	Interchangeable	Interchangeable	Min.600V, min.6A	--	--
Line Choke (L901) for power board type A & C (optional)	CHANNELON	373G0174563H	105°C	--	--
	LDFJ	373G0174563J	105°C	--	--
	LZ	373G0174563Z	105°C	--	--
Line Choke (L901) for power board type B (optional)	HA	73G174-65-H	105°C	--	--
	Taichang	73G174-65-S	105°C	--	--
Transformer (T901) (Alt.)	CHANNELON	380GL32P559H	Class 130 material (B)	Applicable parts of IEC 60950-1 and according to IEC 60085	Accepted by TÜV Rheinland
Bobbin	CHANG CHUN	T200NA	V-0, Phenolic, 150°C	UL 94	UL

IEC 60950-1					
Clause	Requirement + Test			Result - Remark	Verdict
Triple insulation wire	Cosmolink	TIW-M	Max.130°C	IEC/EN 60950-1, VDE0805 Teil1, UL 2353	UL, VDE
Teflon tube	GREAT HOLDING	TEFLON TUBE TFL	200°C	UL 224	UL
Transformer (T901) (Alt.)	LFDJ	380GL32P559J	Class 130 material (B)	Applicable parts of IEC 60950-1 and according to IEC 60085	Accepted by TÜV Rheinland
Bobbin	CHANG CHUN	T200NA	V-0, Phenolic, 150°C	UL 94	UL
Triple insulation wire	Cosmolink	TIW-M	Max.130°C	IEC/EN 60950-1, VDE0805 Teil1, UL 2353	UL, VDE
Teflon tube	GREAT HOLDING	TEFLON TUBE TFL	200°C	UL 224	UL
Transformer (T901) (Alt.)	PHOENIX	380GL32P559P	Class 130 material (B)	Applicable parts of IEC 60950-1 and according to IEC 60085	Accepted by TÜV Rheinland
Bobbin	Sumitomo	PM-9750	V-0, Phenolic, 150°C	UL 94	UL
Triple insulation wire	YUSHENG	TIW-B(x)	Max.130°C	IEC/EN 60950-1, VDE0805 Teil1, UL 2353	UL, VDE
Teflon tube	GREAT HOLDING	TEFLON TUBE TFL	200°C	UL 224	UL
Supplementary information:					
<ol style="list-style-type: none"> 1. Provided evidence ensures the agreed level of compliance. 2. 'Di' means distance through insulation, 'int.' Means internal distance of creepage and 'ext.' Means external distance of creepage. 3. There is no any internal creepage distance. Test according to IEC60950-1:2001, cl. 2.10.8 (same as requirement in IEC60950-1:2005, cl. 2.10.9) has been carried out ten times for the components at 100°C / 25°C / 0°C / 25°C. Humidity treatment of 48 hours as well as electric strength tests at 3000V / 1 minute was carried out to the component after thermal cycling test. 4. All sources of photo coupler were certified according to DIN EN60747-5-2 which in compliance with the requirements and provisions of IEC 60747-5-5. 5. All sources of photo coupler were in compliance with CTL DSH 759 decision. 6. All sources of transformer were checked with same construction. 					

IEC 60950-1			
Clause	Requirement + Test	Result - Remark	Verdict
1.5.1	TABLE: Opto Electronic Devices		P
Manufacturer : See appended table 1.5.1 (List of critical components)			
Type..... : See appended table 1.5.1 (List of critical components)			
Separately tested..... : Tested with appliance			
Bridging insulation : Reinforced insulation.			
External creepage distance : See appended table 1.5.1 (List of critical components)			
Internal creepage distance : See appended table 1.5.1 (List of critical components)			
Distance through insulation : See appended table 1.5.1 (List of critical components)			
Tested under the following conditions :			
Input..... : Tested with appliance			
Output..... : Tested with appliance			
Supplementary information:			

1.6.2	TABLE: Electrical data (in normal conditions)						P
U (V)	I (A)	Irated (A)	P (W)	Fuse #	Ifuse (A)	Condition/status	
Tested on with Panel LM238WF*-**** (LG Display), power board: 715G7300 and main board: 715G8776							
DP mode							
90V/50Hz	0.37	--	20.7	F901	0.37	Normal load condition	
90V/60Hz	0.37	--	20.8	F901	0.37	Normal load condition	
100V/50Hz	0.34	1.5	20.5	F901	0.34	Normal load condition	
100V/60Hz	0.34	1.5	20.6	F901	0.34	Normal load condition	
240V/50Hz	0.20	1.5	20.4	F901	0.20	Normal load condition	
240V/60Hz	0.20	1.5	20.3	F901	0.20	Normal load condition	
264V/50Hz	0.19	--	20.7	F901	0.19	Normal load condition	
264V/60Hz	0.19	--	20.8	F901	0.19	Normal load condition	
HDMI mode							
90V/50Hz	0.36	--	19.5	F901	0.36	Normal load condition	
90V/60Hz	0.36	--	19.4	F901	0.36	Normal load condition	
100V/50Hz	0.33	1.5	19.2	F901	0.33	Normal load condition	
100V/60Hz	0.33	1.5	19.2	F901	0.33	Normal load condition	
240V/50Hz	0.19	1.5	19.0	F901	0.19	Normal load condition	

IEC 60950-1						
Clause	Requirement + Test				Result - Remark	Verdict
240V/60Hz	0.19	1.5	19.1	F901	0.19	Normal load condition
264V/50Hz	0.18	--	19.1	F901	0.18	Normal load condition
264V/60Hz	0.18	--	18.9	F901	0.18	Normal load condition
VGA mode						
90V/50Hz	0.35	--	18.0	F901	0.35	Normal load condition
90V/60Hz	0.35	--	18.1	F901	0.35	Normal load condition
100V/50Hz	0.32	1.5	18.2	F901	0.32	Normal load condition
100V/60Hz	0.32	1.5	18.2	F901	0.32	Normal load condition
240V/50Hz	0.18	1.5	18.0	F901	0.18	Normal load condition
240V/60Hz	0.18	1.5	18.1	F901	0.18	Normal load condition
264V/50Hz	0.17	--	18.1	F901	0.17	Normal load condition
264V/60Hz	0.17	--	18.0	F901	0.17	Normal load condition
Tested on with Panel M270K**-*** (INNOLUX), power board: 715G7300 and main board: 715G8776						
DP mode						
90V/50Hz	0.43	--	27.7	F901	0.43	Normal load condition
90V/60Hz	0.43	--	27.7	F901	0.43	Normal load condition
100V/50Hz	0.38	1.5	27.5	F901	0.38	Normal load condition
100V/60Hz	0.38	1.5	27.6	F901	0.38	Normal load condition
240V/50Hz	0.23	1.5	27.6	F901	0.23	Normal load condition
240V/60Hz	0.23	1.5	27.6	F901	0.23	Normal load condition
264V/50Hz	0.21	--	27.8	F901	0.21	Normal load condition
264V/60Hz	0.22	--	27.7	F901	0.22	Normal load condition
HDMI mode						
90V/50Hz	0.42	--	26.5	F901	0.42	Normal load condition
90V/60Hz	0.43	--	26.5	F901	0.43	Normal load condition
100V/50Hz	0.38	1.5	26.4	F901	0.38	Normal load condition
100V/60Hz	0.38	1.5	26.3	F901	0.38	Normal load condition
240V/50Hz	0.22	1.5	26.2	F901	0.22	Normal load condition
240V/60Hz	0.22	1.5	25.3	F901	0.22	Normal load condition
264V/50Hz	0.21	--	26.4	F901	0.21	Normal load condition
264V/60Hz	0.21	--	26.3	F901	0.21	Normal load condition
VGA mode						
90V/50Hz	0.41	--	24.8	F901	0.41	Normal load condition

IEC 60950-1						
Clause	Requirement + Test				Result - Remark	Verdict
90V/60Hz	0.41	--	25.0	F901	0.41	Normal load condition
100V/50Hz	0.37	1.5	24.7	F901	0.37	Normal load condition
100V/60Hz	0.37	1.5	24.6	F901	0.37	Normal load condition
240V/50Hz	0.21	1.5	24.8	F901	0.21	Normal load condition
240V/60Hz	0.21	1.5	24.8	F901	0.21	Normal load condition
264V/50Hz	0.20	--	24.7	F901	0.20	Normal load condition
264V/60Hz	0.20	--	24.8	F901	0.20	Normal load condition
Tested on with Panel M270K**-*** (INNOLUX), power board: 715G7300 and main board: 715G7778						
HDMI mode						
90V/50Hz	0.40	--	22.4	F901	0.40	Normal load condition
90V/60Hz	0.40	--	22.5	F901	0.40	Normal load condition
100V/50Hz	0.36	1.5	22.3	F901	0.36	Normal load condition
100V/60Hz	0.36	1.5	22.3	F901	0.36	Normal load condition
240V/50Hz	0.20	1.5	22.4	F901	0.20	Normal load condition
240V/60Hz	0.20	1.5	22.5	F901	0.20	Normal load condition
264V/50Hz	0.19	--	22.3	F901	0.19	Normal load condition
264V/60Hz	0.19	--	22.3	F901	0.19	Normal load condition
VGA mode						
90V/50Hz	0.39	--	21.4	F901	0.39	Normal load condition
90V/60Hz	0.39	--	21.5	F901	0.39	Normal load condition
100V/50Hz	0.35	1.5	21.6	F901	0.35	Normal load condition
100V/60Hz	0.35	1.5	21.6	F901	0.35	Normal load condition
240V/50Hz	0.19	1.5	21.4	F901	0.19	Normal load condition
240V/60Hz	0.20	1.5	21.5	F901	0.20	Normal load condition
264V/50Hz	0.18	--	21.3	F901	0.18	Normal load condition
264V/60Hz	0.18	--	21.4	F901	0.18	Normal load condition
Tested on with Panel LM238WF*-**** (LG Display), power board: 715G8852 type B and main board: 715G7762						
VGA mode						
90V/50Hz	0.34	--	17.2	F901	0.34	Normal load condition
90V/60Hz	0.34	--	17.3	F901	0.34	Normal load condition
100V/50Hz	0.32	1.5	17.1	F901	0.32	Normal load condition
100V/60Hz	0.31	1.5	17.2	F901	0.31	Normal load condition
240V/50Hz	0.18	1.5	17.4	F901	0.18	Normal load condition

IEC 60950-1						
Clause	Requirement + Test				Result - Remark	Verdict
240V/60Hz	0.18	1.5	17.3	F901	0.18	Normal load condition
264V/50Hz	0.17	--	17.0	F901	0.17	Normal load condition
264V/60Hz	0.17	--	17.1	F901	0.19	Normal load condition
HDMI mode						
90V/50Hz	0.35	--	18.7	F901	0.35	Normal load condition
90V/60Hz	0.35	--	18.7	F901	0.35	Normal load condition
100V/50Hz	0.32	1.5	18.5	F901	0.32	Normal load condition
100V/60Hz	0.32	1.5	18.5	F901	0.32	Normal load condition
240V/50Hz	0.19	1.5	18.8	F901	0.19	Normal load condition
240V/60Hz	0.19	1.5	18.5	F901	0.19	Normal load condition
264V/50Hz	0.18	--	18.9	F901	0.18	Normal load condition
264V/60Hz	0.18	--	18.9	F901	0.18	Normal load condition
DP mode						
90V/50Hz	0.37	--	19.9	F901	0.37	Normal load condition
90V/60Hz	0.37	--	20.1	F901	0.37	Normal load condition
100V/50Hz	0.38	1.5	20.0	F901	0.38	Normal load condition
100V/60Hz	0.37	1.5	19.8	F901	0.37	Normal load condition
240V/50Hz	0.21	1.5	19.7	F901	0.21	Normal load condition
240V/60Hz	0.21	1.5	19.6	F901	0.21	Normal load condition
264V/50Hz	0.21	--	19.9	F901	0.21	Normal load condition
264V/60Hz	0.20	--	20.2	F901	0.20	Normal load condition
Tested on with Panel LM238WF*-**** (LG Display), power board: 715G8852 type A and main board: 715G8776, USB board 715G8765						
VGA mode						
90V/50Hz	0.65	--	34.2	F901	0.65	Normal load condition
90V/60Hz	0.65	--	34.1	F901	0.65	Normal load condition
100V/50Hz	0.60	1.5	33.6	F901	0.60	Normal load condition
100V/60Hz	0.60	1.5	33.7	F901	0.60	Normal load condition
240V/50Hz	0.34	1.5	33.5	F901	0.34	Normal load condition
240V/60Hz	0.33	1.5	33.6	F901	0.33	Normal load condition
264V/50Hz	0.32	--	33.5	F901	0.32	Normal load condition
264V/60Hz	0.31	--	33.6	F901	0.31	Normal load condition
HDMI mode						
90V/50Hz	0.65	--	34.9	F901	0.65	Normal load condition

IEC 60950-1						
Clause	Requirement + Test				Result - Remark	Verdict
90V/60Hz	0.65	--	35.0	F901	0.65	Normal load condition
100V/50Hz	0.60	1.5	34.4	F901	0.60	Normal load condition
100V/60Hz	0.60	1.5	34.2	F901	0.60	Normal load condition
240V/50Hz	0.34	1.5	34.3	F901	0.34	Normal load condition
240V/60Hz	0.33	1.5	34.1	F901	0.33	Normal load condition
264V/50Hz	0.32	--	34.5	F901	0.32	Normal load condition
264V/60Hz	0.31	--	34.6	F901	0.31	Normal load condition
DP mode						
90V/50Hz	0.65	--	35.9	F901	0.65	Normal load condition
90V/60Hz	0.65	--	35.7	F901	0.65	Normal load condition
100V/50Hz	0.60	1.5	35.6	F901	0.60	Normal load condition
100V/60Hz	0.60	1.5	35.2	F901	0.60	Normal load condition
240V/50Hz	0.34	1.5	35.8	F901	0.34	Normal load condition
240V/60Hz	0.33	1.5	35.7	F901	0.33	Normal load condition
264V/50Hz	0.32	--	35.8	F901	0.32	Normal load condition
264V/60Hz	0.31	--	35.9	F901	0.31	Normal load condition
Tested on with Panel M270K**-*** (INNOLUX), power board: 715G8852 type A and main board: 715G8776, USB board 715G8765						
VGA mode						
90V/50Hz	0.72	--	37.3	F901	0.72	Normal load condition
90V/60Hz	0.72	--	37.0	F901	0.72	Normal load condition
100V/50Hz	0.66	1.5	37.1	F901	0.66	Normal load condition
100V/60Hz	0.66	1.5	37.2	F901	0.66	Normal load condition
240V/50Hz	0.37	1.5	37.2	F901	0.37	Normal load condition
240V/60Hz	0.36	1.5	37.3	F901	0.36	Normal load condition
264V/50Hz	0.34	--	37.3	F901	0.34	Normal load condition
264V/60Hz	0.34	--	37.1	F901	0.34	Normal load condition
HDMI mode						
90V/50Hz	0.72	--	38.9	F901	0.72	Normal load condition
90V/60Hz	0.72	--	39.0	F901	0.72	Normal load condition
100V/50Hz	0.66	1.5	38.7	F901	0.66	Normal load condition
100V/60Hz	0.66	1.5	38.9	F901	0.66	Normal load condition
240V/50Hz	0.37	1.5	38.2	F901	0.37	Normal load condition
240V/60Hz	0.36	1.5	38.5	F901	0.36	Normal load condition

IEC 60950-1						
Clause	Requirement + Test				Result - Remark	Verdict
264V/50Hz	0.34	--	38.3	F901	0.34	Normal load condition
264V/60Hz	0.34	--	38.4	F901	0.34	Normal load condition
DP mode						
90V/50Hz	0.72	--	39.9	F901	0.72	Normal load condition
90V/60Hz	0.72	--	39.8	F901	0.72	Normal load condition
100V/50Hz	0.66	1.5	39.8	F901	0.66	Normal load condition
100V/60Hz	0.66	1.5	39.9	F901	0.66	Normal load condition
240V/50Hz	0.37	1.5	39.8	F901	0.37	Normal load condition
240V/60Hz	0.36	1.5	39.8	F901	0.36	Normal load condition
264V/50Hz	0.34	--	39.6	F901	0.34	Normal load condition
264V/60Hz	0.34	--	39.7	F901	0.34	Normal load condition
Tested on with Panel M270K**-*** (INNOLUX), power board: 715G8852 type C and main board: 715G8853, USB board 715G8765						
VGA mode						
90V/50Hz	1.10	--	63.5	F901	1.10	Normal load condition
90V/60Hz	1.10	--	63.4	F901	1.10	Normal load condition
100V/50Hz	1.01	1.5	63.3	F901	1.01	Normal load condition
100V/60Hz	1.01	1.5	63.3	F901	1.01	Normal load condition
240V/50Hz	0.57	1.5	63.2	F901	0.57	Normal load condition
240V/60Hz	0.57	1.5	63.1	F901	0.57	Normal load condition
264V/50Hz	0.53	--	63.4	F901	0.53	Normal load condition
264V/60Hz	0.53	--	63.5	F901	0.53	Normal load condition
HDMI mode						
90V/50Hz	1.10	--	65.6	F901	1.10	Normal load condition
90V/60Hz	1.10	--	65.5	F901	1.10	Normal load condition
100V/50Hz	1.01	1.5	64.3	F901	1.01	Normal load condition
100V/60Hz	1.01	1.5	64.3	F901	1.01	Normal load condition
240V/50Hz	0.57	1.5	63.7	F901	0.57	Normal load condition
240V/60Hz	0.57	1.5	63.7	F901	0.57	Normal load condition
264V/50Hz	0.53	--	63.8	F901	0.53	Normal load condition
264V/60Hz	0.53	--	63.9	F901	0.53	Normal load condition
DP mode						
90V/50Hz	1.11	--	66.9	F901	1.11	Normal load condition
90V/60Hz	1.10	--	67.0	F901	1.10	Normal load condition

IEC 60950-1						
Clause	Requirement + Test				Result - Remark	Verdict
100V/50Hz	1.01	1.5	66.8	F901	1.01	Normal load condition
100V/60Hz	1.01	1.5	66.6	F901	1.01	Normal load condition
240V/50Hz	0.58	1.5	67.7	F901	0.58	Normal load condition
240V/60Hz	0.58	1.5	66.7	F901	0.58	Normal load condition
264V/50Hz	0.54	--	66.8	F901	0.54	Normal load condition
264V/60Hz	0.53	--	66.8	F901	0.53	Normal load condition
Supplementary information:						
1. Operated under 100% brightness, 100% contrast, full white screen, optimal resolution@60Hz, 2 pieces of speakers loaded with 1KHz noise and turned to maximum volume, each USB 3.0 port loaded with 5V/0.9A, USB 3.0 port with fast charging function loaded 5V/1.5A, which consumed maximum output power consumption.						

2.1.1.5 c) 1)	TABLE: max. V, A, VA test				P
Voltage (rated) (V)	Current (rated) (A)	Voltage (max.) (V)	Current (max.) (A)	VA (max.) (VA)	
Tested with power board 715G7300					
V _{out} output	--	17.8	2.6	44.3	
Supplementary information: Test voltage is 264Vac, 60Hz.					

2.1.1.5	TABLE: max. V, A, VA test				P
Voltage (rated) (V)	Current (rated) (A)	Voltage (max.) (V)	Current (max.) (A)	VA (max.) (VA)	
Tested with power board 715G8852					
19V	--	18.7	3.7	68.9	
Supplementary information: Test voltage is 264Vac, 60Hz.					

2.1.1.5 c) 2)	TABLE: stored energy		N/A
Capacitance C (μF)	Voltage U (V)	Energy E (J)	
Supplementary information:			

IEC 60950-1					
Clause	Requirement + Test			Result - Remark	Verdict
2.1.1.7	TABLE: discharge test				P
Condition	τ calculated (s)	τ measured (s)	t u→ 0V (s)	Comments	
Tested with power board 715G7300					
System on (with fuse in, L-N)	0.66	0.62	--	Vo=373Vpk, 37% of Vo=138Vpk.	
Supplementary information: Overall capacity: C901 = 0.22 μ F, Discharge resistor: R907 (1M Ω) + R908 (1M Ω) + R909 (1M Ω) =3M Ω , Supplied with 264V/60Hz.					

2.1.1.7	TABLE: discharge test				P
Condition	τ calculated (s)	τ measured (s)	t u→ 0V (s)	Comments	
Tested with power board 715G8852					
System on (with fuse in, L-N)	0.86	0.2	--	Vo=375Vpk, 37% of Vo=138.75Vpk.	
Supplementary information: Overall capacity: C903=C922 = 0.22 μ F, Discharge resistor: 1.95M Ω (R901=R902=R903=R933=R934=R935=1.3M Ω) Supplied with 264V/60Hz.					

2.2	TABLE: evaluation of voltage limiting components in SELV circuits			P
Component (measured between)	max. voltage (V) (normal operation)		Voltage Limiting Components	
	V peak	V d.c.		
Tested with power board 715G7300				
T901: Pin 7 - pin 9	69.0	--	--	
After R916 to GND	69.0	--	R916	
After C915/D901 to GND	--	20.2	C915/D901	
After L801 to GND	--	17.9	--	
After D802 (converter board) to GND	--	37.8	--	
Fault test performed on voltage limiting components	Voltage measured (V) in SELV circuits (V peak or V d.c.)			
D901 (S-c)	0V (V _{out} output)			
C915 (S-c)	19.5V (V _{out} output)			

IEC 60950-1			
Clause	Requirement + Test	Result - Remark	Verdict
R916 (S-c)		19.5V (V _{out} output)	
C916 (S-c)		0V (V _{out} output)	
D802 (S-c)		0V (converter output)	
Supplementary information: Input Voltage is 240Vac, 60Hz. S-c = short circuit.			

2.2	TABLE: Hazardous voltage measurement			P
Component (measured between)	max. voltage (V) (normal operation)		Voltage Limiting Components	
	V peak	V d.c.		
Tested with power board 715G8852				
T901 Pin 7,8 to pin 9,10	69	--		
After R917	69	--		
After D905/C914	--	44		
After L801	--	18.9		
After D801	--	40.7		
Fault test performed on voltage limiting components	Voltage measured (V) in SELV circuits (V peak or V d.c.)			
D905 s-c	0 (for +19V output)			
C914 s-c	18.8 (for +19V output)			
D801 s-c	0 (for +19V output)			
L801 s-c	0 (for +19V output)			
Supplementary information: Input Voltage is 240Vac, 60Hz				

2.4.2	TABLE: limited current circuit measurement					P
Location	Voltage (V)	Current (mA)	Freq. (kHz)	Limit (mA)	Comments	
Tested with power board 715G7300						
C913	--	0.27	--	0.7	--	
Supplementary information:						
1. Measured with figure D.1 instrument.						

IEC 60950-1			
Clause	Requirement + Test	Result - Remark	Verdict

2.4.2	TABLE: limited current circuit measurement					P
Location	Voltage (V)	Current (mA)	Freq. (kHz)	Limit (mA)	Comments	
Tested with power board 715G8852						
C913 Secondary pin to Earth	--	0.35	--	0.7	--	
Supplementary information:						
1. Measured with figure D.1 instrument.						

2.5	TABLE: Limited power sources					P
Circuit output tested: V_{out} output on power board 715G7300						
Note: Measured Uoc (V) with all load circuits disconnected:						
Components	Test condition (Single fault)	Uoc (V)	I _{sc} (A)		VA	
			Meas.	Limit	Meas.	Limit
Normal condition	--	17.8	2.6	8	44.3	100
R931	Sc	17.8	5.0	8	88.1	100
U903 A-K	Sc	0 ^{2.}	0 ^{2.}	8	0 ^{2.}	100
R932	Sc	0 ^{2.}	0 ^{2.}	8	0 ^{2.}	100
U902 Pin 1-2	Sc	0 ^{2.}	0 ^{2.}	8	0 ^{2.}	100
U902 Pin 1	Oc	0 ^{2.}	0 ^{2.}	8	0 ^{2.}	100
Supplementary information: Sc=Short circuit, Oc=Open circuit.						
1. Input Voltage is 264Vac, 60Hz.						
2. Unit shut down.						

2.5	TABLE: Limited power sources					P
Circuit output tested: +19V output of power board 715G8852						
Note: Measured Uoc (V) with all load circuits disconnected: See below						
Components	Test condition (Single fault)	Uoc (V)	I _{sc} (A)		VA	
			Meas.	Limit	Meas.	Limit
Normal	--	18.7	3.7	8	68.9	100
R917	Sc	18.7	3.7	8	68.6	100
R927	Sc	18.7	3.7	8	68.1	100
R929	Sc	18.7	3.7	8	68.4	100
R916	Sc	18.7	4.7	8	87.0	100

IEC 60950-1						
Clause	Requirement + Test			Result - Remark		Verdict
R926 short	Sc	18.7	3.8	8	70.5	100
U903 A-K	Sc	18.7	3.7	8	68.3	100
U902 Pin 1-2	Sc	0 ² .	0 ² .	8	0 ² .	100
Supplementary information: Sc=Short circuit, Oc=Open circuit.						
1. Input Voltage is 264Vac, 60Hz.						
2. Unit shut down.						

2.6.3.4	TABLE: ground continue test			P
Location	Resistance measured (mΩ)		Comments	
Tested with power board 715G7300				
PE terminal of AC inlet to internal metal enclosure	4.0		Test with 32A, 2 minutes	
PE terminal of AC inlet to internal metal enclosure	4.0		Test with 40A, 2 minutes	
PE terminal of AC inlet to C902/C903 trace	4.0		Test with 32A, 2 minutes	
PE terminal of AC inlet to C902/C903 trace	4.0		Test with 40A, 2 minutes	
Supplementary information:				

2.6.3.4	TABLE: Resistance of earthing measurement			P
Location	Resistance measured (mΩ)		Comments	
Tested with power board 715G8852				
PE terminal of AC inlet to internal metal enclosure	3.0		Test with 32A, 2 minutes	
PE terminal of AC inlet to internal metal enclosure	3.0		Test with 40A, 2 minutes	
PE terminal of AC inlet to C901/C902 trace	4.0		Test with 32A, 2 minutes	
PE terminal of AC inlet to C901/C902 trace	4.0		Test with 40A, 2 minutes	
Supplementary information:				

2.10.2	Table: working voltage measurement			P
Location	Peak voltage (V)	RMS voltage (V)	Comments	
Tested with power board 715G7300				
T901: Pin 1 to pin 7	400	237		

IEC 60950-1			
Clause	Requirement + Test	Result - Remark	Verdict
T901: Pin 1 to pin 9	378	237	
T901: Pin 2 to pin 7	387	237	
T901: Pin 2 to pin 9	444	237	
T901: Pin 3 to pin 7	438	237	
T901: Pin 3 to pin 9	378	237	
T901: Pin 5 to pin 7	512	260	
T901: Pin 5 to pin 9	531	276	Max. Vpeak & Vrms
C913 primary pin – secondary pin	381	238	
U902 1-3	394	248	
U902 1-4	394	248	
U902 2-3	393	248	
U902 2-4	395	249	
Supplementary information: Input Voltage is 240Vac, 60Hz			

2.10.2	Table: working voltage measurement			P
Location	Peak voltage (V)	RMS voltage (V)	Comments	
Tested with power board 715G8852				
T901 pin 1 to pin 7,8	378	189		
T901 pin 1 to pin 9,10	428	187		
T901 pin 2 to pin 7,8	400	188		
T901 pin 2 to pin 9,10	372	187		
T901 pin 4 to pin 7,8	441	271		
T901 pin 4 to pin 9,10	378	271		
T901 pin 6 to pin 7,8	500	271		
T901 pin 6 to pin 9,10	519	282	The Max. Vrms and Vpeak	
C913	375	188		
U902 1-3	394	197		
U902 1-4	391	196		
U902 2-3	395	197		
U902 2-4	391	195		
supplementary information: Input Voltage is 240Vac, 60Hz				

IEC 60950-1						
Clause	Requirement + Test	Result - Remark				Verdict
2.10.3 and 2.10.4	TABLE: clearance and creepage distance measurements					P
Clearance cl and creepage distance dcr at/of:	U p (V)	U r.m.s. (V)	Required cl (mm)	cl (mm)	Required dcr (mm)	dcr (mm)
Tested with power board 715G7300						
Functional:						
Under fuse (F901) ¹ .	420	250	2.3	2.7	2.5	3.7
Before fuse (between L-N)	420	250	2.3	3.2	2.5	3.2
Basic / supplementary:						
Line-GND ¹ .	420	250	3.0	3.1	3.0	3.3
Neutral-GND	420	250	3.0	3.1	3.0	3.1
Under C902	420	250	3.0	3.8	3.0	3.8
Under C903 ¹ .	420	250	3.0	3.4	3.0	4.8
Primary heatsink HS1 to core of T901	531	276	3.3	4.0	3.3	4.0
Secondary component D901 to core of T901	531	276	3.3	8.8	3.3	8.8
Primary component HS1 to metal enclosure	420	250	3.0	3.8	3.0	3.8
T901 core to metal enclosure	531	276	3.3	6.7	3.3	6.7
Reinforced:						
Under T901	531	276	6.6	8.2	6.6	8.2
U902 primary pin to U902 secondary pin (trace side) ¹ .	420	250	6.0	8.0	6.0	8.2
Under C913 ¹ .	420	250	3.0	7.6	3.0	11.0
Supplementary information:						
1. There is one slot measured 1mm width.						
2. Core of main transformer T901 consider as floating.						
3. One mylar sheet is fixed between primary component trace and panel plate to fulfill the requirement for reinforced insulation. See table 5.2 for the electric strength test for mylar.						
4. Glued component: C907.						
5. Considered altitude correction factor 1.48 for clearances for an altitude of 5000m.						
6. For clearance and creepage that did not describe above are far larger than limit above.						

IEC 60950-1						
Clause	Requirement + Test	Result - Remark				Verdict
2.10.3 and 2.10.4	TABLE: clearance and creepage distance measurements					P
Clearance cl and creepage distance dcr at/of:	U p (V)	U r.m.s. (V)	Required cl (mm)	cl (mm)	Required dcr (mm)	dcr (mm)
Tested with power board 715G8852						
Functional:						
Under fuse (F901) ⁶⁾	420	250	2.3	2.8	2.5	4.4
Before fuse (between L-N) ⁶⁾	420	250	2.3	5.9	2.5	7.2
Basic / supplementary:						
Line-GND ⁶⁾	420	250	3.0	3.1	3.0	3.7
Neutral-GND ⁶⁾	420	250	3.0	3.1	3.0	3.7
Under C901	420	250	3.0	3.6	3.0	6.4
Under C902	420	250	3.0	3.6	3.0	6.4
Primary component (main transformer) to metal enclosure	519	282	3.3	²⁾	3.3	²⁾
Primary component to metal enclosure	519	282	3.3	²⁾	3.3	²⁾
Primary component to solder side to panel	519	282	3.3	³⁾	3.3	³⁾
Reinforced:						
Under T901	519	282	6.3	7.9	6.3	7.9
Under C913	420	250	6.0	7.6	6.0	7.6
Secondary trace to primary trace	519	282	6.6	7.6	6.6	7.6
Secondary component C914 to core of T901	519	282	6.6	8.5	6.6	8.5
U902 primary pin to U902 secondary pin (trace side) ^{1.}	420	250	6.0	8.0	6.0	8.0
Primary conductor of power switch to user accessible area (evaluated for all source of power switch)	420	250	6.0	14.5	6.0	14.5

IEC 60950-1			
Clause	Requirement + Test	Result - Remark	Verdict

Supplementary information:

1. Core of main transformer T901 considered as primary part.
2. There is one mylar sheet fixed between primary components of power board and metal enclosure to fulfill the requirement for basic insulation. See table 5.2 for the electric strength test for mylar.
3. There is one mylar sheet fixed between power board trace and panel plate to fulfill the requirement for basic insulation. See table 5.2 for the electric strength test for mylar.
4. Glued component: C901.
5. Considered altitude correction factor for clearances for an altitude of 5000m (based on IEC 60664-1:1992): 1.48
6. There is one slot measured 1mm width.

2.10.5	TABLE: Distance through insulation measurements				P
Distance through insulation DTI at/of:	U peak (V)	U rms (V)	Test voltage (V)	Required DTI (mm)	DTI (mm)
Photo coupler (reinforced insulation)	420	250	3000	0.4	1.
Mylar sheet between power board trace side and metal plate of panel (reinforced insulation)	420	250	3000	0.4	min. 0.4

Supplementary information:

1. For approved component source see appended table 1.5.1.

4.3.8	TABLE: Batteries								N/A
The tests of 4.3.8 are applicable only when appropriate battery data is not available									
Is it possible to install the battery in a reverse polarity position?									
	Non-rechargeable batteries			Rechargeable batteries					
	Discharging		Un-intentional charging	Charging		Discharging		Reversed charging	
	Meas. current	Manuf. Specs.		Meas. current	Manuf. Specs.	Meas. current	Manuf. Specs.	Meas. current	Manuf. Specs.
Max. current during normal condition									
Max. current during fault condition									
Test results:									Verdict

IEC 60950-1			
Clause	Requirement + Test	Result - Remark	Verdict
	- Chemical leaks		
	- Explosion of the battery		
	- Emission of flame or expulsion of molten metal		
	- Electric strength tests of equipment after completion of tests		
Supplementary information:			

4.3.8	TABLE: Batteries	
Battery category..... : (Lithium, NiMh, NiCad, Lithium Ion ...)		
Manufacturer		
Type / model.....		
Voltage		
Capacity..... : mAh		
Tested and Certified by (incl. Ref. No.)		
Circuit protection diagram:		

MARKINGS AND INSTRUCTIONS (1.7.13)	
Location of replaceable battery	
Language(s)	
Close to the battery	
In the servicing instructions	
In the operating instructions	

4.5	TABLE: Thermal requirements						P
	Supply voltage (V)	90V/ 60Hz	264V/ 60Hz	--	--	--	—
	Ambient T _{min} (°C)	22.9	22.5	--	--	--	—
	Ambient T _{max} (°C)	22.9	22.5	--	--	--	—
Maximum measured temperature T of part/at.....:		T (°C)					Allowed T _{max} (°C)
Tested on with Panel LM238WF*-**** (LG Display), power board: 715G7300 and main board: 715G8776, DP mode							
	AC Inlet body CN901 (on power board)	30.9	29.6	--	--	--	52.5
	PCB near NR901 (on power board)	45.2	36.0	--	--	--	87.5
	L901 Coil body (on power board)	43.9	35.2	--	--	--	87.5

IEC 60950-1							
Clause	Requirement + Test			Result - Remark			Verdict
C902 body (on power board)	33.9	32.3	--	--	--	67.5	
C901 body (on power board)	35.2	32.2	--	--	--	67.5	
PCB near BD901 (on power board)	37.7	34.7	--	--	--	87.5	
C907 body (on power board)	45.9	38.1	--	--	--	87.5	
PCB near Q901 body (on power board)	46.2	43.9	--	--	--	87.5	
T901 coil (on power board)	50.7	53.6	--	--	--	92.5	
T901 core (on power board)	51.1	52.9	--	--	--	92.5	
C913 Body (on power board)	41.2	38.6	--	--	--	67.5	
U902 Body (on power board)	40.4	38.6	--	--	--	82.5	
PCB near D901 (on power board)	53.5	54.8	--	--	--	87.5	
PCB near L801 (on power board)	51.1	50.2	--	--	--	87.5	
PCB near U401 (on main board)	35.6	35.2	--	--	--	87.5	
PCB near U801 (on power board)	48.6	46.5				87.5	
Metal enclosure	32.0	31.4	--	--	--	52.5	
Plastic enclosure inside near T901	29.5	29.0	--	--	--	--	
Plastic enclosure outside	26.4	26.2	--	--	--	77.5	
Panel surface	29.5	29.1	--	--	--	77.5	
Supplementary information:							
Temperature T of winding:	t ₁ (°C)	R ₁ (Ω)	t ₂ (°C)	R ₂ (Ω)	T (°C)	Allowed T _{max} (°C)	Insulation class
Supplementary information:							
1. The temperatures were measured under the worst case normal mode defined in 1.2.2.1 and as described in sub-clause 1.6.2 at voltages as described above.							
2. With a specified ambient temperature of 40°C. Temperature limits are calculated as follows:							
Winding components providing safety isolation:							
- Class B: T _{max} = 120 - 10 - 40 + T _{amb}							
Components with maximum absolute temperature of others:							
- T _{max} = T _{max} of component - 40 + T _{amb}							

IEC 60950-1							
Clause	Requirement + Test	Result - Remark					Verdict
4.5	TABLE: Thermal requirements						P
	Supply voltage (V)	90V/ 60Hz	264V/ 60Hz	--	--	--	—
	Ambient T _{min} (°C)	22.9	22.5	--	--	--	—
	Ambient T _{max} (°C)	22.9	22.5	--	--	--	—
Maximum measured temperature T of part/at.....:		T (°C)					Allowed T _{max} (°C)
Tested on with Panel M270K**-*** (INNOLUX), power board: 715G7300 and main board: 715G8776, DP mode							
	AC Inlet body CN901 (on power board)	30.9	30.3	--	--	--	52.5
	PCB near NR901 (on power board)	36.9	44.7	--	--	--	87.5
	L901 Coil body (on power board)	36.2	43.4	--	--	--	87.5
	C902 body (on power board)	33.7	33.3	--	--	--	67.5
	C901 body (on power board)	33.3	35.0	--	--	--	67.5
	PCB near BD901 (on power board)	36.2	37.3	--	--	--	87.5
	C907 body (on power board)	39.8	46.1	--	--	--	87.5
	PCB near Q901 body (on power board)	45.8	45.4	--	--	--	87.5
	T901 coil (on power board)	54.2	50.8	--	--	--	92.5
	T901 core (on power board)	54.7	51.2	--	--	--	92.5
	C913 Body (on power board)	40.0	41.2	--	--	--	67.5
	U902 Body (on power board)	40.5	39.9	--	--	--	82.5
	PCB near D901 (on power board)	57.3	53.5	--	--	--	87.5
	PCB near L801 (on power board)	50.1	49.5	--	--	--	87.5
	PCB near U401 (on main board)	38.6	37.0	--	--	--	87.5
	PCB near U801 (on power board)	46.3	46.8				87.5
	Metal enclosure	32.3	31.5	--	--	--	52.5
	Plastic enclosure inside near T901	29.3	28.5	--	--	--	--
	Plastic enclosure outside	26.9	26.0	--	--	--	77.5
	Panel surface	30.3	29.1	--	--	--	77.5
Supplementary information:							
Temperature T of winding:	t ₁ (°C)	R ₁ (Ω)	t ₂ (°C)	R ₂ (Ω)	T (°C)	Allowed T _{max} (°C)	Insulation class

IEC 60950-1			
Clause	Requirement + Test	Result - Remark	Verdict

Supplementary information:

- The temperatures were measured under the worst case normal mode defined in 1.2.2.1 and as described in sub-clause 1.6.2 at voltages as described above.
- With a specified ambient temperature of 40°C. Temperature limits are calculated as follows:

Winding components providing safety isolation:

 - Class B: $T_{max} = 120 - 10 - 40 + T_{amb}$

Components with maximum absolute temperature of others:

 - $T_{max} = T_{max} \text{ of component} - 40 + T_{amb}$

4.5	TABLE: Thermal requirements					P
	Supply voltage (V)	90V/ 60Hz horizontal	264V/ 60Hz horizontal	90V/ 60Hz vertical	264V/ 60Hz vertical	—
	Ambient Tmin (°C)	19.2	18.4	19.6	18.8	—
	Ambient Tmax (°C)	19.2	18.4	19.6	18.8	—
Maximum measured temperature T of part/at.....:		T (°C)				Allowed T _{max} (°C)
Tested on with Panel LM238WF*_*_*_*_* (LG Display), power board: 715G8852 type A and main board: 715G8776, USB board 715G8765, DP mode						
	Line pin of AC Inlet CN901(on power board)	33.1	31.2	32.3	30.7	48.4
	C913 body (on power board)	46.0	48.3	40.5	41.7	63.4
	PCB near NR901 (on power board)	60.3	44.6	53.5	41.5	83.4
	C901 body (on power board)	36.8	33.2	35.6	32.8	63.4
	C902 body (on power board)	35.7	35.0	36.5	34.0	63.4
	L901 coil (on power board)	46.3	37.4	40.7	33.9	83.4
	PCB near BD901 (on power board)	54.4	44.6	52.5	41.7	83.4
	C904 body (on power board)	45.0	41.0	40.9	37.8	83.4
	Transformer coil (on power board)	52.3	56.0	50.3	53.2	98.4
	Transformer core(on power board)	48.7	51.9	45.2	47.3	98.4
	U902 body (on power board)	43.0	43.1	36.6	36.9	78.4
	PCB near Q901 (on power board)	53.0	52.3	47.9	48.4	83.4
	PCB near D901 (on power board)	49.9	56.8	50.7	55.8	83.4
	PCB near U401 body (main board)	40.0	39.7	41.2	41.5	83.4
	PCB near L801 (on power board)	54.1	52.9	56.2	55.7	83.4
	PCB near U801 (on power board)	43.3	41.2	38.9	38.4	83.4
	Plastic enclosure inside near Transformer	31.8	31.3	30.3	29.8	--
	Plastic enclosure outside	29.6	28.0	28.1	27.6	38.4

IEC 60950-1							
Clause	Requirement + Test				Result - Remark		Verdict
Panel surface	29.4	29.6	27.7	28.9	73.4		
Metal enclosure	33.6	32.4	31.4	30.7	48.4		
Tested on with Panel LM238WF*-**** (LG Display), power board: 715G8852 type B and main board: 715G7762, DP mode							
L901 coil (on power board)	37.9	40.1	35.5	38.2	83.4		
Supplementary information:							
Temperature T of winding:	t ₁ (°C)	R ₁ (Ω)	t ₂ (°C)	R ₂ (Ω)	T (°C)	Allowed T _{max} (°C)	Insulation class
Supplementary information:							
1. The temperatures were measured under the worst case normal mode defined in 1.2.2.1 and as described in sub-clause 1.6.2 at voltages as described above.							
2. With a specified ambient temperature of 40°C. Temperature limits are calculated as follows:							
Winding components providing safety isolation:							
- Class B: T _{max} = 120 - 10 - 40 + T _{amb}							
Components with maximum absolute temperature of others:							
- T _{max} = T _{max} of component - 40 + T _{amb}							

4.5	TABLE: Thermal requirements					P
Supply voltage (V)	90V/ 60Hz horizontal	264V/ 60Hz horizontal	90V/ 60Hz vertical	264V/ 60Hz vertical	—	
Ambient T _{min} (°C)	19.2	18.4	19.6	18.8	—	
Ambient T _{max} (°C)	19.2	18.4	19.6	18.8	—	
Maximum measured temperature T of part/at.....:	T (°C)				Allowed T _{max} (°C)	
Tested on with Panel M270K**-*** (INNOLUX), power board: 715G8852 type C and main board: 715G8853, USB board 715G8765, DP mode						
Line pin of AC Inlet CN901(on power board)	42.0	39.8	39.9	37.4	48.4	
C913 body (on power board)	62.9	64.1	58.9	61.8	63.4	
PCB near NR901 (on power board)	79.5	60.2	71.2	55.6	83.4	
C901 body (on power board)	48.0	43.0	46.3	42.1	63.4	
C902 body (on power board)	47.9	46.1	48.3	44.0	63.4	
L901 coil (on power board)	75.5	54.0	68.9	50.0	83.4	
PCB near BD901 (on power board)	82.8	66.7	82.8	62.5	83.4	
C904 body (on power board)	58.8	49.7	56.1	47.1	83.4	

IEC 60950-1							
Clause	Requirement + Test			Result - Remark	Verdict		
Transformer coil (on power board)	78.2	77.5	74.8	72.6	98.4		
Transformer core(on power board)	73.3	74.2	69.8	67.7	98.4		
U902 body (on power board)	65.0	65.0	62.1	60.9	78.4		
PCB near Q901 (on power board)	90.0	80.2	81.5	72.7	83.4		
PCB near D901 (on power board)	73.5	79.8	77.1	80.0	83.4		
PCB near U401 body (main board)	52.8	53.7	58.3	57.4	83.4		
PCB near L801 (on power board)	69.7	65.6	50.2	49.2	83.4		
PCB near U801 (on power board)	70.4	66.7	61.9	60.4	83.4		
Plastic enclosure inside near Transformer	31.0	33.6	32.7	31.6	--		
Plastic enclosure outside	34.9	34.2	31.7	31.9	38.4		
Panel surface	37.4	37.3	37.0	37.1	73.4		
Metal enclosure	36.7	35.2	37.4	37.8	48.4		
Supplementary information:							
Temperature T of winding:	t ₁ (°C)	R ₁ (Ω)	t ₂ (°C)	R ₂ (Ω)	T (°C)	Allowed T _{max} (°C)	Insulation class
Supplementary information:							
1. The temperatures were measured under the worst case normal mode defined in 1.2.2.1 and as described in sub-clause 1.6.2 at voltages as described above.							
2. With a specified ambient temperature of 40°C. Temperature limits are calculated as follows:							
Winding components providing safety isolation:							
- Class B: T _{max} = 120 - 10 - 40 + Tamb							
Components with maximum absolute temperature of others:							
- T _{max} = T _{max} of component - 40 + Tamb							

4.5.5	TABLE: Ball pressure test of thermoplastic parts		P
	Allowed impression diameter (mm)	≤ 2 mm	—
Part	Test temperature (°C)	Impression diameter (mm)	
Line choke (L901), Chang Chun, type PBT-4115	125	1.0	
Line choke (L901), Chang Chun, type PBT-5630	125	1.0	
Plastic enclosure, Kingfa: HIPS-5197, 2.5mm	90	1.59	
Plastic enclosure, Kingfa: GAR-011(L85), 2.5mm	85	1.31	
Plastic enclosure, Kingfa: GAR-011(L65), 2.5mm	85	1.29	
Plastic enclosure, Kingfa: HIPS-510(H), 2.5mm	80	1.29	

IEC 60950-1			
Clause	Requirement + Test	Result - Remark	Verdict
	Plastic enclosure, Kingfa: FRHIPS-960, 2.5mm	85	1.88
	Plastic enclosure, Cheil: GC-0750(+), 2.5mm	80	1.61
	Plastic enclosure, Cheil: GC-0700(+), 2.5mm	80	1.94
	Plastic enclosure, Cheil: HG-0760(+), 2.5mm	85	1.73
	Plastic enclosure, Cheil: LX-0951(+), 2.5mm	85	1.83
	Plastic enclosure, Cheil: SD-0150, 2.5mm	85	1.48
	Plastic enclosure, Cheil: HR-1360, 2.5mm	85	1.71
	Plastic enclosure, Cheil: BF-0670F, 2.5mm	80	1.59
	Plastic enclosure, LG: HF380, 2.5mm	85	1.48
	Plastic enclosure, LG: SE885, 2.5mm	80	1.42
	Plastic enclosure, LG: LUPOY GP-1000(#), 2.5mm	95	1.21
	Plastic enclosure, LG: XG568, 2.5mm	80	1.81
	Plastic enclosure, LG: XG569C, 2.5mm	80	1.85
	Plastic enclosure, LG: HF388H, 2.5mm	85	1.39
	Plastic enclosure, LG: SE750, 2.5mm	80	1.5
	Plastic enclosure, Teijin: TN-7500, 2.5mm	85	1.57
	Plastic enclosure, ORINKO: HIPS-2000, 2.5mm	85	1.48
	Plastic enclosure, Kingfa: GAR-011C, 2.5mm	90	1.91
Supplementary information: Above mentioned plastic enclosure material was tested by client's request.			

4.6.1, 4.6.2	Table: Enclosure opening measurements		P
Location	Size (mm)	Comments	
External Plastic enclosure type A and type A'			
Top	No opening.	--	
Rear	Numerous oval openings: 4.2mm x 2.0mm	No hazardous part within vertical projection of 5° from the opening.	
Right	No opening.	--	
Left	No opening.	--	
Bottom	No opening.	--	

IEC 60950-1			
Clause	Requirement + Test	Result - Remark	Verdict
Internal metal enclosure type A			
Top	1) One rectangle opening above main board: 39.4mm x 5.2mm 2) Numerous circle openings above main board: Ø4.8mm.	1) Opening is covered by plastic enclosure. No hazards. 2) Openings do not exceed 5mm in any dimension. No hazards.	
Rear	1) One rectangle opening near power board: 40.0mm x 34.9mm; 2) One rectangle opening near main board: 50.1mm x 30.1mm (Optional) 3) Numerous circle openings above main board: Ø3.9mm. 4) Circle openings above main board: 2xØ13.9mm. 5) Circle openings above main board: Ø9.5mm (Optional).	1)-2) No hazardous part within vertical projection of 5° from the opening. 3) Openings do not exceed 5mm in any dimension. No hazards. 4)-5) No hazardous part within vertical projection of 5° from the opening.	
Left	One rectangle opening near main board: 35.9mm x 12.1mm	No hazardous part within vertical projection of 5° from the opening.	
Right	One opening near power board for secondary connector to LED backlight: 40.0mm x 21.7mm.	The opening is filled by V-1 material connector CN801, no hazards.	
Bottom	Under power board: numerous Ø1.7mm holes; spacing of holes (centre to centre): 5.2 mm; thickness of metal: min.0.81mm	Metal enclosure is considered to satisfy the requirement for bottom openings of fire enclosure.	

IEC 60950-1			
Clause	Requirement + Test	Result - Remark	Verdict
Internal metal enclosure type B: a) horizontal orientation, b) vertical orientation (power board on bottom)			
a) Top b) Right	1) One rectangle opening above main board: 39.4mm x 5.2mm 2) Two rectangle opening above power board: 15.5mm x 7.9mm 3) Numerous circle openings above main board: Ø4.8mm.	1) Opening is covered by plastic enclosure. No hazards. 2) No hazardous part within vertical projection of 5° from the opening. 3) Openings do not exceed 5mm in any dimension. No hazards.	
a) Rear b) Rear	1) One rectangle opening near power board: 40.0mm x 34.9mm; 2) One rectangle opening near main board: 50.1mm x 30.1mm (Optional) 3) Numerous circle openings above main board: Ø3.9mm. 4) Circle openings above main board: 2xØ13.9mm. 5) Circle openings above main board: Ø9.5mm (Optional).	1) The opening is filled by V-1 Mylar sheet, no hazards. 2) No hazardous part within vertical projection of 5° from the opening. 3) Openings do not exceed 5mm in any dimension. No hazards. 4)-5) No hazardous part within vertical projection of 5° from the opening.	
a) Left b) Top	One rectangle opening near main board: 35.9mm x 12.1mm	The opening is filled by plastic enclosure, no hazards.	
a) Right b) Bottom	One opening near power board for secondary connector to LED backlight: 40.0mm x 21.7mm.	The opening is filled by V-1 Mylar sheet, no hazards.	
a) Bottom b) Left	Under power board: numerous Ø1.7mm holes; spacing of holes (centre to centre): 5.2 mm; thickness of metal: min.0.81mm	Metal enclosure is considered to satisfy the requirement for bottom openings of fire enclosure.	
Supplementary information:			

IEC 60950-1					
Clause	Requirement + Test			Result - Remark	Verdict
4.7	TABLE: Resistance to fire				P
Part	Manufacturer of material	Type of material	Thickness (mm)	Flammability class	Evidence
PCB	--	--	--	V-1	UL
Plastic enclosure *	--	--	--	HB	UL
Mylar sheet	--	--	--	V-1	UL
Supplementary information: See table 1.5.1.					

5.1	TABLE: touch current measurement			P
Measured between:	Measured (mA)	Limit (mA)	Comments/conditions	
Tested with power board 715G7300				
L – metal enclosure	0.22	3.5	Switch “e” open	
N – metal enclosure	0.22	3.5	Switch “e” open	
L – signal connector	0.01	0.25	Switch “e” close *	
N – signal connector	0.01	0.25	Switch “e” close *	
L – plastic enclosure	0.01	0.25	Switch “e” close	
N – plastic enclosure	0.01	0.25	Switch “e” close	
Supplementary information: Supplied with 264V/60Hz.				
* Test performed with functional earthing disconnected.				

5.1	TABLE: touch current measurement			P
Measured between:	Measured (mA)	Limit (mA)	Comments/conditions	
Tested with power board 715G8852				
L – metal enclosure	0.29	3.5	Switch “e” open	
N – metal enclosure	0.27	3.5	Switch “e” open	
L – signal connector	0.01	0.25	Switch “e” close *	
N – signal connector	0.01	0.25	Switch “e” close *	
L – plastic enclosure	0.01	0.25	Switch “e” close	
N – plastic enclosure	0.01	0.25	Switch “e” close	
Supplementary information: Supplied with 264V/60Hz.				
* Test performed with functional earthing disconnected.				

IEC 60950-1				
Clause	Requirement + Test	Result - Remark	Verdict	
5.2	TABLE: Electric strength tests, impulse tests and voltage surge tests		P	
Test voltage applied between:		Voltage shape (AC, DC, impulse, surge)	Test voltage (V)	Breakdown Yes / No
Tested with power board 715G7300				
Basic/supplementary:				
Unit primary to earthed metal part		AC	1803	No
T901 ¹⁾ : primary to core		AC	1803	No
T901 ¹⁾ : secondary to core		AC	1803	No
Reinforced:				
Unit: primary and Plastic enclosure with metal foil		AC	3000	No
Mylar sheet between power board trace side and panel plate ²⁾		AC	3000	No
Unit primary to secondary (output)		DC	4242	No
T901 ¹⁾ : primary to secondary		AC	3000	No
T901 ¹⁾ : each layer of insulation tape		AC	3000	No
Supplementary information:				
1. For all sources of T901;				
2. For all sources of mylar sheet;				
3. The test mentioned above were performed after humidity conditioning test.				

IEC 60950-1				
Clause	Requirement + Test	Result - Remark	Verdict	
5.2	TABLE: Electric strength tests, impulse tests and voltage surge tests		P	
Test voltage applied between:		Voltage shape (AC, DC, impulse, surge)	Test voltage (V)	Breakdown Yes / No
Tested with power board 715G8852				
Basic/supplementary:				
Unit: primary and earth metal part		AC	1772	no
Reinforced:				
Unit: primary and Plastic enclosure with metal foil		AC	3000	no
Unit: primary to secondary(output)		DC	4242	no
T901 ¹⁾ : secondary and core		AC	3000	no
T901 ¹⁾ : two layers of three layers insulation tape		AC	3000	no
T901 ¹⁾ : Primary and Secondary		AC	3000	no

IEC 60950-1			
Clause	Requirement + Test	Result - Remark	Verdict

Mylar sheet between power board trace side and panel plate ²⁾	AC	3000	No
Supplementary information:			
1. For all sources of T901;			
2. For all sources of mylar sheet;			
3. The test mentioned above were performed after humidity conditioning test.			

5.3	TABLE: Fault condition tests						P
	Ambient temperature (°C)					See below	—
	Power source for EUT: ManuFacterer, model/type, output rating						—
Component No.	Fault	Supply voltage (V)	Test time	Fuse #	Fuse current (A)	Observation	
Tested on with Panel LM238WF*-**** (LG Display), power board: 715G7300 and main board: 715G8776, DP mode							
BD901 pin 2-4	s-c	264	<1 sec	F901	--	Fuse F901 opened instantly, no hazard.	
C907	s-c	264	<1 sec	F901	--	Fuse F901 opened instantly, no hazard.	
Q901 pin G-S	s-c	264	5 min	F901	0.04	Unit shut down, no hazard.	
Q901 pin D-G	s-c	264	5 min	F901	0.04	R928, Q901 and U901 damaged, no hazards. This test was repeated twice (three tests total) with same result.	
Q901 pin D-S	s-c	264	5 min	F901	0.04	R931 and Q901 damaged, no hazards. This test was repeated twice (three tests total) with same result.	
U901 Pin 1 to Pin 5	s-c	264	5 min	F901	0.04	Unit shut down, no hazard.	
U901 Pin 2 to Pin 5	s-c	264	5 min	F901	0.04	Unit shut down, no hazard.	
U902 pin 1 - 2	s-c	264	5 min	F901	0.04	Unit shut down, no hazard.	
U902 pin 3 - 4	s-c	264	5 min	F901	0.04	Unit shut down, no hazard.	
U902 pin 1	o-c	264	5 min	F901	0.04	Unit shut down, no hazard.	

IEC 60950-1						
Clause	Requirement + Test			Result - Remark		Verdict
U902 pin 3	o-c	264	5 min	F901	0.04	Unit shut down, no hazard.
C916	s-c	264	5 min	F901	0.04	Unit shut down, no hazard.
D901	s-c	264	5 min	F901	0.04	Unit shut down, no hazard.
T901 pin 1 to pin 2	s-c	264	5 min	F901	0.06	Unit shut down, no hazard.
T901 pin 3 to pin 5	s-c	264	5 min	F901	0.06	Unit shut down, no hazard.
T901 pin 7 to pin 9	s-c	264	5 min	F901	0.03	Unit shut down, no hazard.
V _{out} output to earth	s-c	264	5 min	F901	0.04	Unit shut down, no hazard.
Converter output to earth	s-c	264	5 min	F901	0.04	Unit shut down, no hazard.
Ventilation openings	blocked	264	4 hrs	F901	0.19	Unit operated normally, no hazards, no damage. After temperature reached stable, max. measured temp. in T901 coil=73.0°C, T901 core=72.7°C, U902 body=59.2°C, ambient=23.1°C.
T901 pin 7 to 9 (after D901) (V _{out} output)	o-l	240	6.5 hrs	F901	0.67	Max. measured temp.in T901 coil=115.8°C, T901 core=112.7°C, U902 body=78.2°C, ambient=24.2°C. before shutdown winding is loaded to 2.1A. No damage, no hazards.
Supplementary information:						
<ol style="list-style-type: none"> The unit passed 3000V hi-pot test between primary and accessible output connector after single fault test above. In fault column, where s-c=short-circuited, o-c=open-circuited, o-l = overload. For fuse opened conditions were tested with each source of fuse. For component damaged conditions have been repeated twice (three tests total) with same result. Temp. limit of transformer according to table C.1 is 150°C - 10 - (40°C - Tamb) for Class A. 						

IEC 60950-1						
Clause	Requirement + Test				Result - Remark	Verdict
5.3	TABLE: Fault condition tests					P
	Ambient temperature (°C)				See below	—
	Power source for EUT: Manufacturer, model/type, output rating					—
Component No.	Fault	Supply voltage (V)	Test time	Fuse #	Fuse current (A)	Observation
Tested on with Panel M270K**_*** (INNOLUX), power board: 715G8852 type C and main board: 715G8853, USB board 715G8765, DP mode						
BD901 pin 2-4	s-c	264	<1 sec	F901	--	Fuse F901 opened instantly, no hazard.
C901	s-c	264	<1 sec	F901	--	Fuse F901 opened instantly, no hazard.
Q901 pin G-S	s-c	264	5 min	F901	0.04	Unit shut down, no hazard.
Q901 pin D-G	s-c	264	5 min	F901	--	R914, Q901 damaged. No hazards. This test was repeated twice (three tests total) with same result.
Q901 pin D-S	s-c	264	5 min	F901	--	Q901 damaged. No hazards. This test was repeated twice (three tests total) with same result.
U901 Pin 1 to Pin 5	s-c	264	5 min	F901	--	R911 damaged. No hazards. This test was repeated twice (three tests total) with same result.
U901 Pin 2 to Pin 5	s-c	264	5 min	F901	--	C912, U901 damaged. No hazards. This test was repeated twice (three tests total) with same result.
U901 Pin 2 to Pin 6	s-c	264	5 min	F901	--	C912, U901 damaged. No hazards. This test was repeated twice (three tests total) with same result.
U902 pin 1 - 2	s-c	264	5 min	F901	0.04	Unit shut down, no hazard.
U902 pin 3 - 4	s-c	264	5 min	F901	0.04	Unit shut down, no hazard.
U902 pin 1	s-c	264	5 min	F901	0.04	Unit shut down, no hazard.

IEC 60950-1						
Clause	Requirement + Test				Result - Remark	Verdict
R916	s-c	264	5 min	F901	0.51	Unit operated normally, no hazards
C911	s-c	264	5 min	F901	0.03	Unit shut down, no hazard.
D902	s-c	264	5 min	F901	0.03	Unit shut down, no hazard.
D901	s-c	264	5 min	F901	0.03	Unit shut down, no hazard.
+19V output to earth	s-c	264	5 min	F901	0.05	Unit shut down, no hazard.
T901 pin 1 to pin 2	s-c	264	5 min	F901	0.04	Unit shut down, no hazard.
T901 pin 4 to pin 6	s-c	264	5 min	F901	0.04	Unit shut down, no hazard.
T901 pin 7,8 to pin 9,10	s-c	264	5 min	F901	0.06	Unit shut down, no hazard.
Ventilation openings	blocked	240	4.7 hrs	F901	0.54	Unit operated normally, no hazards, no damaged. After temperature reached stable, max. measured temp. in T901 coil = 86.5°C, T901 core = 76.7°C, U902 = 69.0°C ambient = 21.9°C.
T901 pin 7,8 to pin 9,10 after D905 (+19V)	o-l	264	8.5 hrs	F901	0.65	Max. measured temp. in T901 coil = 92.5°C, T901 core = 80.4°C, U902 = 69.4°C ambient = 24.4°C, before shut down winding is loaded to 1.2A. No hazards.
USB 3.0 output	o-l	264	4 hrs	F901	0.57	Max. measured temp. in T901 coil = 84.2°C, T901 core = 80.9°C, U902 = 65.6°C ambient = 25.9°C. Before shutdown USB is loaded to 2.4A. No damage, no hazards.

IEC 60950-1			
Clause	Requirement + Test	Result - Remark	Verdict

Supplementary information:

6. The unit passed 3000V hi-pot test between primary and accessible output connector after single fault test above.
7. In fault column, where s-c=short-circuited, o-c=open-circuited, o-l = overload.
8. For fuse opened conditions were tested with each source of fuse.
9. For component damaged conditions have been repeated twice (three tests total) with same result.
10. Temp. limit of transformer according to table C.1 is 175°C-10-(40°C-Tamb) (worst case) for Class B.

IEC 60950-1							
Clause	Requirement + Test			Result - Remark			Verdict
C.2	TABLE: transformers (for power board 715G7300)						P
Loc.	Tested insulation	Working voltage peak / V (2.10.2)	Working voltage rms / V (2.10.2)	Required electric strength (5.2)	Required clearance / mm (2.10.3)	Required creepage distance / mm (2.10.4)	Required distance thr. insul. (2.10.5)
T901	Input terminal to output winding (RI)	531	276	AC 3000V	6.6	6.6	Min. 2 layers tape
T901	Input terminal to output terminal (RI)	531	276	AC 3000V	6.6	6.6	Min. 2 layers tape
T901	Input winding to output winding (RI)	531	276	AC 3000V	6.6	6.6	Min. 2 layers tape
T901	Input winding to output terminal (RI)	531	276	AC 3000V	6.6	6.6	Min. 2 layers tape
T901	Input winding to Core (BI)	531	276	AC 1803V	3.3	3.3	--
T901	Input terminal to Core (BI)	531	276	AC 1803V	3.3	3.3	--
T901	Output winding to Core (BI)	531	276	AC 1803V	3.3	3.3	--
T901	Output terminal to Core (BI)	531	276	AC 1803V	3.3	3.3	--
Loc.	Tested insulation			Test voltage/ V	Measured clearance / mm	Measured creepage dist./ mm	Measured distance thr. insul. / mm; number of layers
T901	Input terminal to output winding (RI)			AC 3000V	7.6	7.6	3 layers tape
T901	Input terminal to output terminal (RI)			AC 3000V	22.5	22.5	3 layers tape
T901	Input winding to output winding (RI)			AC 3000V	8.4	8.4	3 layers tape
T901	Input winding to output terminal (RI)			AC 3000V	8.0	8.0	3 layers tape
T901	Input terminal to Core (BI)			AC 1803V	5.5	5.5	--
T901	Input winding to Core (BI)			AC 1803V	4.2	4.2	--
T901	Output terminal to Core (BI)			AC 1803V	5.5	5.5	--

IEC 60950-1

Clause	Requirement + Test	Result - Remark			Verdict
T901	Output winding to Core (BI)	AC 1803V	4.2	4.2	--
Supplementary information: All sources of transformer were checked with same construction.					

C.2 **TABLE: transformers** **P**

Construction:

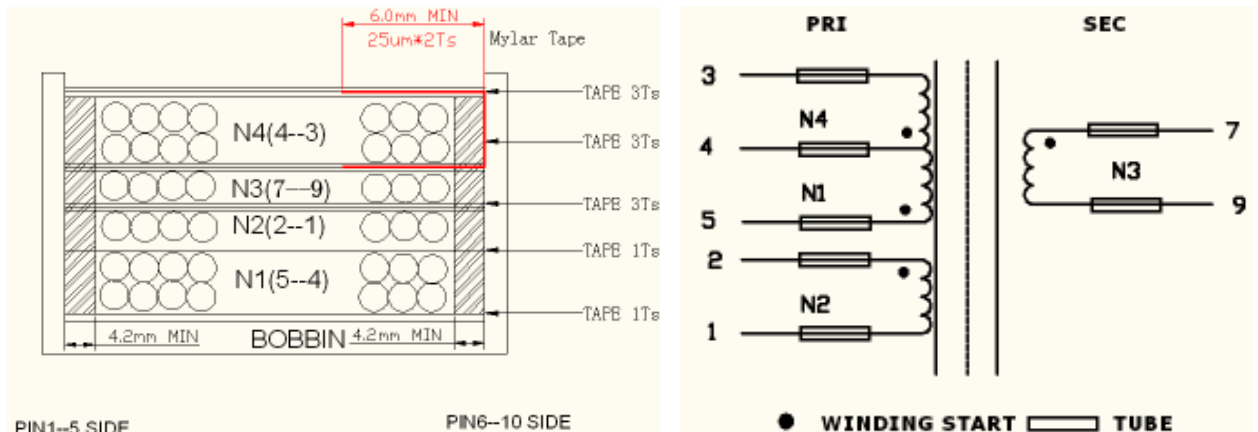

NO.	Winding	Terminal	Wire	Turns	Remark	MARGIN mm	TAPE
							1T
1	N1	5—4	UEW φ0.35	23	CLOSED	4.2mm/4.2mm	1T
2	N2	2—1	UEW φ0.35*3	7	CLOSED	4.2mm/4.2mm	3Ts
3	N3	7—9	UEW φ0.35*3	7	CLOSED	4.2mm/4.2mm	3Ts
4	N4	4--3	UEW φ0.35	22	CLOSED	4.2mm/4.2mm	3Ts

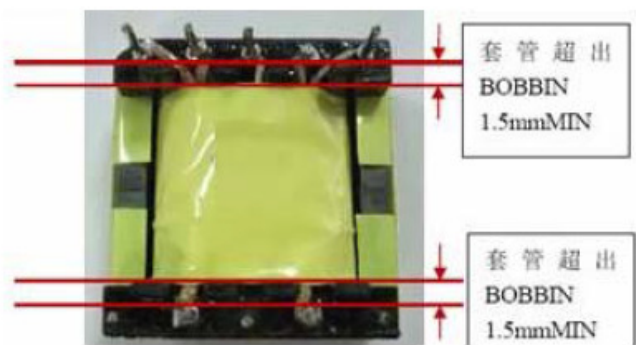
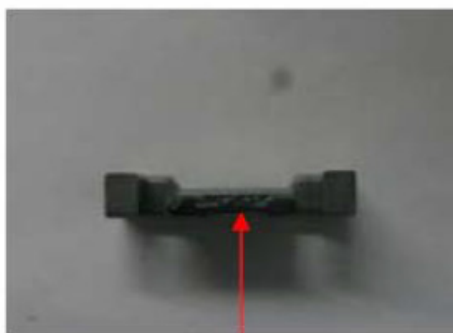

EPOXY WEIGHT: 0.05g REF(軟膠)

IEC 60950-1			
Clause	Requirement + Test	Result - Remark	Verdict

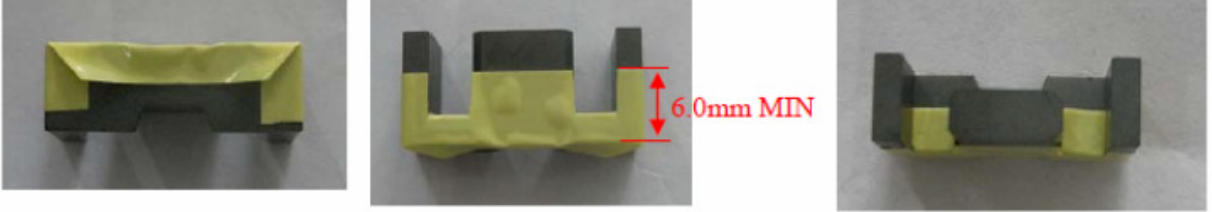
<p style="text-align: center; color: red;">磁芯背膠</p>  <p>Concentric windings on phenolic bobbin. Three layers of insulation tape are provided around outer winding and outer winding is primary. Three layers of insulation tape are provided between the primary windings and secondary windings. The core is considered as floating part. At least 4.2mm margin tape at both primary solder pin side and secondary solder pin side. Two layers of fold back insulation tape provided on primary winding N4 at secondary pin side. All winding leads are covered by tube.</p>			
---	--	--	--

IEC 60950-1							
Clause	Requirement + Test			Result - Remark			Verdict
C.2	TABLE: transformers (for power board 715G8852)						P
Loc.	Tested insulation	Working voltage peak / V (2.10.2)	Working voltage rms / V (2.10.2)	Required electric strength (5.2)	Required clearance / mm (2.10.3)	Required creepage distance / mm (2.10.4)	Required distance thr. insul. (2.10.5)
T901	Input terminal to output winding (RI)	519	282	AC 3000V	6.6	6.6	Min. 2 layers tape
T901	Input terminal to output terminal (RI)	519	282	AC 3000V	6.6	6.6	Min. 2 layers tape
T901	Input winding to output winding (RI)	519	282	AC 3000V	6.6	6.6	Min. 2 layers tape
T901	Input winding to output terminal (RI)	519	282	AC 3000V	6.6	6.6	Min. 2 layers tape
T901	Output winding to Core (RI)	519	282	AC 3000V	6.6	6.6	--
T901	Output terminal to Core (RI)	519	282	AC 3000V	6.6	6.6	--
Loc.	Tested insulation			Test voltage / V	Measured clearance / mm	Measured creepage dist. / mm	Measured distance thr. insul. / mm; number of layers
T901	Input terminal to output winding (RI)			AC 3000V	Triple insulated wire used for secondary	Triple insulated wire used for secondary	--
T901	Input terminal to output terminal (RI)			AC 3000V	28.5	28.5	2 layers tape
T901	Input winding to output winding (RI)			AC 3000V	Triple insulated wire used for secondary	Triple insulated wire used for secondary	--
T901	Input winding to output terminal (RI)			AC 3000V	8.0	8.0	2 layers tape
T901	Output winding to Core (RI)			AC 3000V	Triple insulated wire used for secondary	Triple insulated wire used for secondary	--

IEC 60950-1

Clause	Requirement + Test	Result - Remark	Verdict
--------	--------------------	-----------------	---------

T901	Output terminal to Core (RI)	AC 3000V	7.5	7.5	--
------	------------------------------	----------	-----	-----	----

Supplementary information: All sources of transformer were checked with same construction.

C.2 **TABLE: transformers** **P**

Construction:

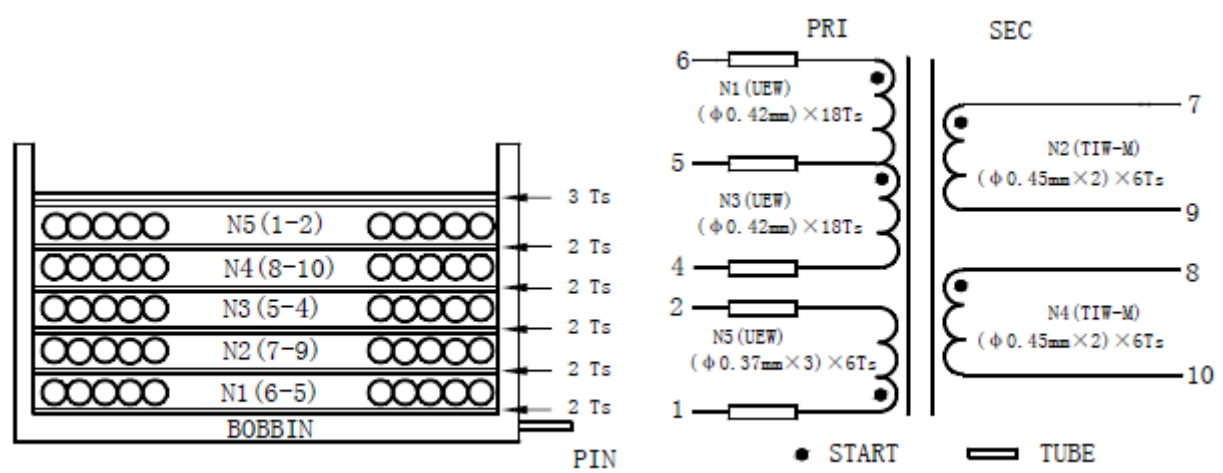

No.	COIL	TERMINAL	WIRE GAUGE	WIRE TYPE	TUNS	WINDING METHOD	TAPE/2Ts
1	N1	6-5	φ 0.42 mm	UEW	18	CLOSED	2Ts
2	N2	7-9	φ 0.45mm×2	TIW-M	6	CLOSED	2Ts
3	N3	5-4	φ 0.42 mm	UEW	18	CLOSED	2Ts
4	N4	8-10	φ 0.45mm×2	TIW-M	6	CLOSED	2Ts
5	N5	1-2	φ 0.37 mm×3	UEW	6	CLOSED	3Ts

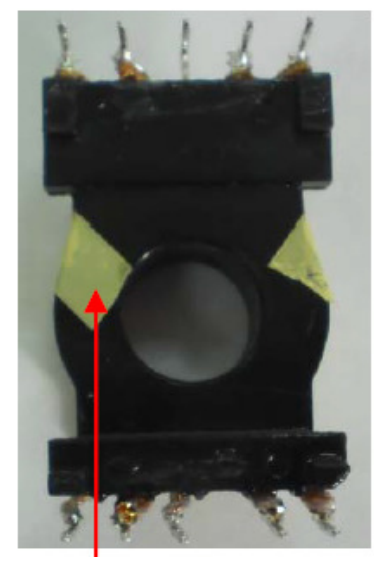
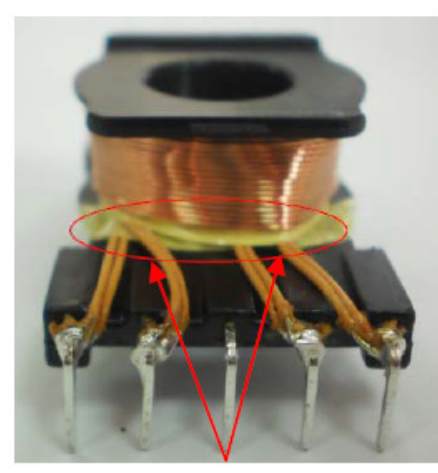

Concentric windings on phenolic bobbin. Three layers of insulation tape are provided around outer winding and outer winding is primary. Triple insulated wire used for secondary, therefore core is considered as primary. All winding leads are covered by tube.

IEC60950_1F - ATTACHMENT			
Clause	Requirement + Test	Result - Remark	Verdict

ATTACHMENT TO TEST REPORT IEC 60950-1 EUROPEAN GROUP DIFFERENCES AND NATIONAL DIFFERENCES Information technology equipment – Safety – Part 1: General requirements			
Differences according to: EN 60950-1:2006/A11:2009/A1:2010/A12:2011/A2:2013			
Attachment Form No.: EU_GD_IEC60950_1F			
Attachment Originator: SGS Fimko Ltd			
Master Attachment: Date 2014-02			
Copyright © 2014 IEC System for Conformity Testing and Certification of Electrical Equipment (IECEE), Geneva, Switzerland. All rights reserved.			

EN 60950-1:2006/A11:2009/A1:2010/A12:2011/A2:2013 – CENELEC COMMON MODIFICATIONS			
--	--	--	--

IEC 60950-1, GROUP DIFFERENCES (CENELEC common modifications EN)			
Clause	Requirement + Test	Result - Remark	Verdict
	Clauses, subclauses, notes, tables and figures which are additional to those in IEC60950-1 and it's amendmets are prefixed "Z"		P
Contents (A2:2013)	Add the following annexes: Annex ZA (normative) Normative references to international publications with their corresponding European publications Annex ZB (normative) Special national conditions Annex ZD (informative) IEC and CENELEC code designations for flexible cords		P
General	Delete all the "country" notes in the reference document (IEC 60950-1:2005) according to the following list: 1.4.8 Note 2 1.5.1 Note 2 & 3 1.5.7.1 Note 1.5.8 Note 2 1.5.9.4 Note 1.7.2.1 Note 4, 5 & 6 2.2.3 Note 2.2.4 Note 2.3.2 Note 2.3.2.1 Note 2 2.3.4 Note 2 2.6.3.3 Note 2 & 3 2.7.1 Note 2.10.3.2 Note 2 2.10.5.13 Note 3 3.2.1.1 Note 3.2.4 Note 3. 2.5.1 Note 2 4.3.6 Note 1 & 2 4.7 Note 4 4.7.2.2 Note 4.7.3.1Note 2 5.1.7.1 Note 3 & 4 5.3.7 Note 1 6 Note 2 & 5 6.1.2.1 Note 2 6.1.2.2 Note 6.2.2 Note 6.2.2.1 Note 2 6.2.2.2 Note 7.1 Note 3 7.2 Note 7.3 Note 1 & 2 G.2.1 Note 2 Annex H Note 2		P
General (A1:2010)	Delete all the "country" notes in the reference document (IEC 60950-1:2005/A1:2010) according to the following list: 1.5.7.1 Note 6.1.2.1 Note 2 6.2.2.1 Note 2 EE.3 Note		P

IEC60950_1F - ATTACHMENT			
Clause	Requirement + Test	Result - Remark	Verdict

IEC 60950-1, GROUP DIFFERENCES (CENELEC common modifications EN)			
Clause	Requirement + Test	Result - Remark	Verdict
General (A2:2013)	Delete all the "country" notes in the reference document (IEC 60950-1:2005/A2:2013) according to the following list: 2.7.1 Note * 2.10.3.1 Note 2 6.2.2. Note * Note of secretary: Text of Common Modification remains unchanged.		P
1.1.1 (A1:2010)	Replace the text of NOTE 3 by the following. NOTE 3 The requirements of EN 60065 may also be used to meet safety requirements for multimedia equipment. See IEC Guide 112, Guide on the safety of multimedia equipment. For television sets EN 60065 applies.		P
1.3.Z1	Add the following subclause: 1.3.Z1 Exposure to excessive sound pressure The apparatus shall be so designed and constructed as to present no danger when used for its intended purpose, either in normal operating conditions or under fault conditions, particularly providing protection against exposure to excessive sound pressures from headphones or earphones. NOTE Z1 A new method of measurement is described in EN 50332-1, Sound system equipment: Headphones and earphones associated with portable audio equipment - Maximum sound pressure level measurement methodology and limit considerations - Part 1: General method for "one package equipment", and in EN 50332-2, Sound system equipment: Headphones and earphones associated with portable audio equipment - Maximum sound pressure level measurement methodology and limit considerations - Part 2: Guidelines to associate sets with headphones coming from different manufacturers.	Added.	N/A
(A12:2011)	In EN 60950-1:2006/A12:2011 Delete the addition of 1.3.Z1 / EN 60950-1:2006 Delete the definition 1.2.3.Z1 / EN 60950-1:2006 /A1:2010	Deleted.	N/A
1.5.1 (Added info*)	Add the following NOTE: NOTE Z1 The use of certain substances in electrical and electronic equipment is restricted within the EU: see Directive 2002/95/EC. New Directive 2011/65/11 *	Added.	P
1.7.2.1 (A1:2010)	In addition, for a PORTABLE SOUND SYSTEM, the instructions shall include a warning that excessive sound pressure from earphones and headphones can cause hearing loss.	Added.	N/A
1.7.2.1 (A12:2011)	In EN 60950-1:2006/A12:2011 Delete NOTE Z1 and the addition for Portable Sound System. Add the following clause and annex to the existing standard and amendments.		N/A
	Zx Protection against excessive sound pressure from personal music players		N/A

IEC60950_1F - ATTACHMENT			
Clause	Requirement + Test	Result - Remark	Verdict

IEC 60950-1, GROUP DIFFERENCES (CENELEC common modifications EN)			
Clause	Requirement + Test	Result - Remark	Verdict
	<p>Zx.1 General</p> <p>This sub-clause specifies requirements for protection against excessive sound pressure from personal music players that are closely coupled to the ear. It also specifies requirements for earphones and headphones intended for use with personal music players.</p> <p>A personal music player is a portable equipment for personal use, that:</p> <ul style="list-style-type: none"> – is designed to allow the user to listen to recorded or broadcast sound or video; and – primarily uses headphones or earphones that can be worn in or on or around the ears; and – allows the user to walk around while in use. <p>NOTE 1 Examples are hand-held or body-worn portable CD players, MP3 audio players, mobile phones with MP3 type features, PDA's or similar equipment.</p> <p>A personal music player and earphones or headphones intended to be used with personal music players shall comply with the requirements of this sub-clause.</p> <p>The requirements in this sub-clause are valid for music or video mode only.</p> <p>The requirements do not apply:</p> <ul style="list-style-type: none"> – while the personal music player is connected to an external amplifier; or – while the headphones or earphones are not used. <p>NOTE 2 An external amplifier is an amplifier which is not part of the personal music player or the listening device, but which is intended to play the music as a standalone music player.</p> <p>The requirements do not apply to:</p> <ul style="list-style-type: none"> – hearing aid equipment and professional equipment; <p>NOTE 3 Professional equipment is equipment sold through special sales channels. All products sold through normal electronics stores are considered not to be professional equipment.</p>	Not personal music player	N/A

IEC60950_1F - ATTACHMENT			
Clause	Requirement + Test	Result - Remark	Verdict

IEC 60950-1, GROUP DIFFERENCES (CENELEC common modifications EN)			
Clause	Requirement + Test	Result - Remark	Verdict
	<p>– analogue personal music players (personal music players without any kind of digital processing of the sound signal) that are brought to the market before the end of 2015.</p> <p>NOTE 4 This exemption has been allowed because this technology is falling out of use and it is expected that within a few years it will no longer exist. This exemption will not be extended to other technologies.</p> <p>For equipment which is clearly designed or intended for use by young children, the limits of EN 71-1 apply.</p>		
	<p>Zx.2 Equipment requirements</p> <p>No safety provision is required for equipment that complies with the following:</p> <ul style="list-style-type: none"> – equipment provided as a package (personal music player with its listening device), where the acoustic output $L_{Aeq,T}$ is ≤ 85 dBA measured while playing the fixed “programme simulation noise” as described in EN 50332-1; and – a personal music player provided with an analogue electrical output socket for a listening device, where the electrical output is ≤ 27 mV measured as described in EN 50332-2, while playing the fixed “programme simulation noise” as described in EN 50332-1. <p>NOTE 1 Wherever the term acoustic output is used in this clause, the 30 s A-weighted equivalent sound pressure level $L_{Aeq,T}$ is meant. See also Zx.5 and Annex Zx.</p> <p>All other equipment shall:</p> <ol style="list-style-type: none"> a) protect the user from unintentional acoustic outputs exceeding those mentioned above; and b) have a standard acoustic output level not exceeding those mentioned above, and automatically return to an output level not exceeding those mentioned above when the power is switched off; and 	Not such equipment.	N/A

IEC60950_1F - ATTACHMENT			
Clause	Requirement + Test	Result - Remark	Verdict

IEC 60950-1, GROUP DIFFERENCES (CENELEC common modifications EN)			
Clause	Requirement + Test	Result - Remark	Verdict
	<p>c) provide a means to actively inform the user of the increased sound pressure when the equipment is operated with an acoustic output exceeding those mentioned above. Any means used shall be acknowledged by the user before activating a mode of operation which allows for an acoustic output exceeding those mentioned above. The acknowledgement does not need to be repeated more than once every 20 h of cumulative listening time; and</p> <p>NOTE 2 Examples of means include visual or audible signals. Action from the user is always required.</p> <p>NOTE 3 The 20 h listening time is the accumulative listening time, independent how often and how long the personal music player has been switched off.</p> <p>d) have a warning as specified in Zx.3; and</p> <p>e) not exceed the following:</p> <ol style="list-style-type: none"> 1) equipment provided as a package (player with its listening device), the acoustic output shall be ≤ 100 dBA measured while playing the fixed "programme simulation noise" described in EN 50332-1; and 2) a personal music player provided with an analogue electrical output socket for a listening device, the electrical output shall be ≤ 150 mV measured as described in EN 50332-2, while playing the fixed "programme simulation noise" described in EN 50332-1. <p>For music where the average sound pressure (long term $L_{Aeq,T}$) measured over the duration of the song is lower than the average produced by the programme simulation noise, the warning does not need to be given as long as the average sound pressure of the song is below the basic limit of 85 dBA. In this case T becomes the duration of the song.</p> <p>NOTE 4 Classical music typically has an average sound pressure (long term $L_{Aeq,T}$) which is much lower than the average programme simulation noise. Therefore, if the player is capable to analyse the song and compare it with the programme simulation noise, the warning does not need to be given as long as the average sound pressure of the song is below the basic limit of 85 dBA.</p> <p>For example, if the player is set with the programme simulation noise to 85 dBA, but the average music level of the song is only 65 dBA, there is no need to give a warning or ask an acknowledgement as long as the average sound level of the song is not above the basic limit of 85 dBA.</p>		

IEC60950_1F - ATTACHMENT			
Clause	Requirement + Test	Result - Remark	Verdict

IEC 60950-1, GROUP DIFFERENCES (CENELEC common modifications EN)			
Clause	Requirement + Test	Result - Remark	Verdict
	<p>Zx.3 Warning</p> <p>The warning shall be placed on the equipment, or on the packaging, or in the instruction manual and shall consist of the following:</p> <ul style="list-style-type: none"> – the symbol of Figure 1 with a minimum height of 5 mm; and – the following wording, or similar: <p>“To prevent possible hearing damage, do not listen at high volume levels for long periods.”</p> <div style="text-align: center;">  </div> <p>Figure 1 – Warning label (IEC 60417-6044)</p> <p>Alternatively, the entire warning may be given through the equipment display during use, when the user is asked to acknowledge activation of the higher level.</p>	Not such equipment	N/A
	<p>Zx.4 Requirements for listening devices (headphones and earphones)</p>		N/A
	<p>Zx.4.1 Wired listening devices with analogue input</p> <p>With 94 dBA sound pressure output $L_{Aeq,T}$, the input voltage of the fixed “programme simulation noise” described in EN 50332-2 shall be ≥ 75 mV.</p> <p>This requirement is applicable in any mode where the headphones can operate (active or passive), including any available setting (for example built-in volume level control).</p> <p>NOTE The values of 94 dBA – 75 mV correspond with 85dBA – 27 mV and 100 dBA – 150 mV.</p>	Not such equipment	N/A

IEC60950_1F - ATTACHMENT			
Clause	Requirement + Test	Result - Remark	Verdict

IEC 60950-1, GROUP DIFFERENCES (CENELEC common modifications EN)			
Clause	Requirement + Test	Result - Remark	Verdict
	<p>Zx.4.2 Wired listening devices with digital input</p> <p>With any playing device playing the fixed “programme simulation noise” described in EN 50332-1 (and respecting the digital interface standards, where a digital interface standard exists that specifies the equivalent acoustic level), the acoustic output $L_{Aeq,T}$ of the listening device shall be ≤ 100 dBA.</p> <p>This requirement is applicable in any mode where the headphones can operate, including any available setting (for example built-in volume level control, additional sound feature like equalization, etc.).</p> <p>NOTE An example of a wired listening device with digital input is a USB headphone.</p>	Not such equipment	N/A
	<p>Zx.4.3 Wireless listening devices</p> <p>In wireless mode:</p> <ul style="list-style-type: none"> – with any playing and transmitting device playing the fixed programme simulation noise described in EN 50332-1; and – respecting the wireless transmission standards, where an air interface standard exists that specifies the equivalent acoustic level; and – with volume and sound settings in the listening device (for example built-in volume level control, additional sound feature like equalization, etc.) set to the combination of positions that maximize the measured acoustic output for the abovementioned programme simulation noise, the acoustic output $L_{Aeq,T}$ of the listening device shall be ≤ 100 dBA. <p>NOTE An example of a wireless listening device is a Bluetooth headphone.</p>	Not such equipment	N/A
	<p>Zx.5 Measurement methods</p> <p>Measurements shall be made in accordance with EN 50332-1 or EN 50332-2 as applicable. Unless stated otherwise, the time interval T shall be 30 s.</p> <p>NOTE Test method for wireless equipment provided without listening device should be defined.</p>	Not such equipment	N/A

IEC60950_1F - ATTACHMENT			
Clause	Requirement + Test	Result - Remark	Verdict

IEC 60950-1, GROUP DIFFERENCES (CENELEC common modifications EN)									
Clause	Requirement + Test	Result - Remark	Verdict						
2.7.1	<p>Replace the subclause as follows:</p> <p>Basic requirements</p> <p>To protect against excessive current, short-circuits and earth faults in PRIMARY CIRCUITS, protective devices shall be included either as integral parts of the equipment or as parts of the building installation, subject to the following, a), b) and c):</p> <p>a) except as detailed in b) and c), protective devices necessary to comply with the requirements of 5.3 shall be included as parts of the equipment;</p> <p>b) for components in series with the mains input to the equipment such as the supply cord, appliance coupler, r.f.i. filter and switch, short-circuit and earth fault protection may be provided by protective devices in the building installation;</p>	Replaced.	P						
	<p>c) it is permitted for PLUGGABLE EQUIPMENT TYPE B or PERMANENTLY CONNECTED EQUIPMENT, to rely on dedicated overcurrent and short-circuit protection in the building installation, provided that the means of protection, e.g. fuses or circuit breakers, is fully specified in the installation instructions.</p> <p>If reliance is placed on protection in the building installation, the installation instructions shall so state, except that for PLUGGABLE EQUIPMENT TYPE A the building installation shall be regarded as providing protection in accordance with the rating of the wall socket outlet.</p>	No such equipment	N/A						
2.7.2	This subclause has been declared 'void'.		N/A						
3.2.3	Delete the NOTE in Table 3A, and delete also in this table the conduit sizes in parentheses.	Unit is not a permanently connected equipment.	N/A						
3.2.5.1	<p>Replace "60245 IEC 53" by "H05 RR-F";</p> <p>"60227 IEC 52" by "H03 VV-F or H03 VVH2-F";</p> <p>"60227 IEC 53" by "H05 VV-F or H05 VVH2-F2".</p> <p>In Table 3B, replace the first four lines by the following:</p> <table style="margin-left: 40px;"> <tr> <td>Up to and including 6 </td> <td>0,75^{a)} </td> </tr> <tr> <td>Over 6 up to and including 10 </td> <td>(0,75)^{b)} 1,0 </td> </tr> <tr> <td>Over 10 up to and including 16 </td> <td>(1,0)^{c)} 1,5 </td> </tr> </table> <p>In the conditions applicable to Table 3B delete the words "in some countries" in condition^{a)}.</p> <p>In NOTE 1, applicable to Table 3B, delete the second sentence.</p>	Up to and including 6	0,75 ^{a)}	Over 6 up to and including 10	(0,75) ^{b)} 1,0	Over 10 up to and including 16	(1,0) ^{c)} 1,5	No power supply cord provided.	N/A
Up to and including 6	0,75 ^{a)}								
Over 6 up to and including 10	(0,75) ^{b)} 1,0								
Over 10 up to and including 16	(1,0) ^{c)} 1,5								
3.2.5.1 (A2:2013)	NOTE Z1 The harmonised code designations corresponding to the IEC cord types are given in Annex ZD		N/A						

IEC60950_1F - ATTACHMENT			
Clause	Requirement + Test	Result - Remark	Verdict

IEC 60950-1, GROUP DIFFERENCES (CENELEC common modifications EN)			
Clause	Requirement + Test	Result - Remark	Verdict
3.3.4	In Table 3D, delete the fourth line: conductor sizes for 10 to 13 A, and replace with the following: Over 10 up to and including 16 1,5 to 2,5 1,5 to 4 Delete the fifth line: conductor sizes for 13 to 16 A		N/A
4.3.13.6 (A1:2010)	Replace the existing NOTE by the following: NOTE Z1 Attention is drawn to: 1999/519/EC: Council Recommendation on the limitation of exposure of the general public to electromagnetic fields 0 Hz to 300 GHz, and 2006/25/EC: Directive on the minimum health and safety requirements regarding the exposure of workers to risks arising from physical agents (artificial optical radiation).		N/A
	Standards taking into account mentioned Recommendation and Directive which demonstrate compliance with the applicable EU Directive are indicated in the OJEC.		N/A
Annex H	Replace the last paragraph of this annex by: At any point 10 cm from the surface of the OPERATOR ACCESS AREA, the dose rate shall not exceed 1 µSv/h (0,1 mR/h) (see NOTE). Account is taken of the background level. Replace the notes as follows: NOTE These values appear in Directive 96/29/Euratom. Delete NOTE 2.		N/A
Bibliography	Additional EN standards.		—

ZA	NORMATIVE REFERENCES TO INTERNATIONAL PUBLICATIONS WITH THEIR CORRESPONDING EUROPEAN PUBLICATIONS	—
-----------	--	---

ZB ANNEX (normative) SPECIAL NATIONAL CONDITIONS (EN)			
1.2.4.1	In Denmark , certain types of Class I appliances (see 3.2.1.1) may be provided with a plug not establishing earthing conditions when inserted into Danish socket-outlets.		N/A
1.2.13.14 (A11:2009)	In Norway and Sweden , for requirements see 1.7.2.1 and 7.3 of this annex.		N/A
1.5.7.1 (A11:2009)	In Finland , Norway and Sweden , resistors bridging BASIC INSULATION in CLASS I PLUGGABLE EQUIPMENT TYPE A must comply with the requirements in 1.5.7.1. In addition when a single resistor is used, the resistor must withstand the resistor test in 1.5.7.2.	No such resistors.	N/A

IEC60950_1F - ATTACHMENT			
Clause	Requirement + Test	Result - Remark	Verdict
1.5.8	In Norway , due to the IT power system used (see annex V, Figure V.7), capacitors are required to be rated for the applicable line-to-line voltage (230 V).		P
1.5.9.4	In Finland, Norway and Sweden , the third dashed sentence is applicable only to equipment as defined in 6.1.2.2 of this annex.		N/A
1.7.2.1	In Finland, Norway and Sweden , CLASS I PLUGGABLE EQUIPMENT TYPE A intended for connection to other equipment or a network shall, if safety relies on connection to protective earth or if surge suppressors are connected between the network terminals and accessible parts, have a marking stating that the equipment must be connected to an earthed mains socket-outlet. The marking text in the applicable countries shall be as follows: In Finland : "Laitte on liitettävä suojakoskettimilla varustettuun pistorasiaan" In Norway : "Apparatet må tilkoples jordet stikkontakt" In Sweden : "Apparaten skall anslutas till jordat uttag"		P
1.7.2.1 (A11:2009)	In Norway and Sweden , the screen of the cable distribution system is normally not earthed at the entrance of the building and there is normally no equipotential bonding system within the building. Therefore the protective earthing of the building installation need to be isolated from the screen of a cable distribution system. It is however accepted to provide the insulation external to the equipment by an adapter or an interconnection cable with galvanic isolator, which may be provided by e.g. a retailer. The user manual shall then have the following or similar information in Norwegian and Swedish language respectively, depending on in what country the equipment is intended to be used in: "Equipment connected to the protective earthing of the building installation through the mains connection or through other equipment with a connection to protective earthing – and to a cable distribution system using coaxial cable, may in some circumstances create a fire hazard. Connection to a cable distribution system has therefore to be provided through a device providing electrical isolation below a certain frequency range (galvanic isolator, see EN 60728-11)."		

IEC60950_1F - ATTACHMENT			
Clause	Requirement + Test	Result - Remark	Verdict
	<p>NOTE In Norway, due to regulation for installations of cable distribution systems, and in Sweden, a galvanic isolator shall provide electrical insulation below 5 MHz. The insulation shall withstand a dielectric strength of 1,5 kV r.m.s., 50 Hz or 60 Hz, for 1 min.</p> <p>Translation to Norwegian (the Swedish text will also be accepted in Norway):</p> <p>“Utstyr som er koplet til beskyttelsesjord via nettplugg og/eller via annet jordtilkople</p> <p>utstyr – og er tilkople et kabel-TV nett, kan forårsake brannfare. For å unngå dette skal det ved tilkopling av utstyret til kabel-TV nettet installeres en galvanisk isolator mellom utstyret og kabel- TV nettet.”</p> <p>Translation to Swedish:</p> <p>”Utrustning som är kopplad till skyddsjord via jordat vägguttag och/eller via annan</p> <p>utrustning och samtidigt är kopplad till kabel-TV nät kan i vissa fall medföra risk för</p> <p>brand. För att undvika detta skall vid anslutning av utrustningen till kabel-TV nät</p> <p>galvanisk isolator finnas mellan utrustningen och kabel-TV nätet.”</p>		
1.7.2.1 (A2:2013)	<p>In Denmark, CLASS I PLUGGABLE EQUIPMENT TYPE A intended for connection to other equipment or a network shall, if safety relies on connection to protective earth or if surge suppressors are connected between the network terminals and accessible parts, have a marking stating that the equipment must be connected to an earthed mains socket-outlet.</p> <p>The marking text in Denmark shall be as follows: In Denmark: “Apparatets stikprop skal tilsluttes en stikkontakt med jord, som giver forbindelse til stikproppens jord.”</p>		P
1.7.5 1.7.5 (A11:2009)	<p>In Denmark, socket-outlets for providing power to other equipment shall be in accordance with the Heavy Current Regulations, Section 107-2-D1, Standard Sheet DK 1-3a, DK 1-5a or DK 1-7a, when used on Class I equipment. For STATIONARY EQUIPMENT the socket-outlet shall be in accordance with Standard Sheet DK 1-1b or DK 1-5a.</p> <p>For CLASS II EQUIPMENT the socket outlet shall be in accordance with Standard Sheet DKA 1-4a.</p>	No socket-outlet provided.	N/A

IEC60950_1F - ATTACHMENT			
Clause	Requirement + Test	Result - Remark	Verdict
1.7.5 (A2:2013)	<p>In Denmark, socket-outlets for providing power to other equipment shall be in accordance with the DS 60884-2-D1:2011.</p> <p>For class I equipment the following Standard Sheets are applicable: DK 1-3a, DK 1-1c, DK 1-1d, DK 1-5a or DK 1-7a, with the exception for STATIONARY EQUIPMENT where the socket-outlets shall be in accordance with Standard Sheet DK 1-1b, DK 1-1c, DK 1-1d or DK 1-5a.</p> <p>Socket outlets intended for providing power to Class II apparatus with a rated current of 2,5 A shall be in accordance with DS 60884-2-D1 standard sheet DKA 1-4a. Other current rating socket outlets shall be in compliance with by DS 60884-2-D1 Standard Sheet DKA 1-3a or DKA 1-3b.</p> <p>Justification the Heavy Current Regulations, 6c</p>	No socket-outlet provided.	N/A
2.2.4	In Norway , for requirements see 1.7.2.1, 6.1.2.1 and 6.1.2.2 of this annex.	No TNV.	N/A
2.3.2	In Finland, Norway and Sweden there are additional requirements for the insulation. See 6.1.2.1 and 6.1.2.2 of this annex.	No TNV.	N/A
2.3.4	In Norway , for requirements see 1.7.2.1, 6.1.2.1 and 6.1.2.2 of this annex.	No TNV.	N/A
2.6.3.3	In the United Kingdom , the current rating of the circuit shall be taken as 13 A, not 16 A.		P
2.7.1	In the United Kingdom , to protect against excessive currents and short-circuits in the PRIMARY CIRCUIT of DIRECT PLUG-IN EQUIPMENT, tests according to 5.3 shall be conducted, using an external protective device rated 30 A or 32 A. If these tests fail, suitable protective devices shall be included as integral parts of the DIRECT PLUG-IN EQUIPMENT, so that the requirements of 5.3 are met.	Not direct plug-in equipment	N/A
2.10.5.13	In Finland, Norway and Sweden , there are additional requirements for the insulation, see 6.1.2.1 and 6.1.2.2 of this annex.		N/A
3.2.1.1	<p>In Switzerland, supply cords of equipment having a RATED CURRENT not exceeding 10 A shall be provided with a plug complying with SEV 1011 or IEC 60884-1 and one of the following dimension sheets:</p> <p>SEV 6532-2.1991 Plug Type 15 3P+N+PE 250/400 V, 10 A</p>	No supply cords provided.	N/A

IEC60950_1F - ATTACHMENT			
Clause	Requirement + Test	Result - Remark	Verdict
	<p>SEV 6533-2.1991 Plug Type 11 L+N 250 V, 10 A</p> <p>SEV 6534-2.1991 Plug Type 12 L+N+PE 250 V, 10 A</p> <p>In general, EN 60309 applies for plugs for currents exceeding 10 A. However, a 16 A plug and socket-outlet system is being introduced in Switzerland, the plugs of which are according to the following dimension sheets, published in February 1998: SEV 5932-2.1998: Plug Type 25 , 3L+N+PE 230/400 V, 16 A</p> <p>SEV 5933-2.1998: Plug Type 21, L+N, 250 V, 16A</p> <p>SEV 5934-2.1998: Plug Type 23, L+N+PE 250 V, 16 A</p>		
3.2.1.1	<p>In Denmark, supply cords of single-phase equipment having a rated current not exceeding 13 A shall be provided with a plug according to the Heavy Current Regulations, Section 107-2-D1. CLASS I EQUIPMENT provided with socket-outlets with earth contacts or which are intended to be used in locations where protection against indirect contact is required according to the wiring rules shall be provided with a plug in accordance with standard sheet DK 2-1a or DK 2-5a. If poly-phase equipment and single-phase equipment having a RATED CURRENT exceeding 13 A is provided with a supply cord with a plug, this plug shall be in accordance with the Heavy Current Regulations, Section 107-2-D1 or EN 60309-2.</p>	No supply cords provided.	N/A
3.2.1.1 (A2:2013)	<p>In Denmark, supply cords of single-phase equipment having a rated current not exceeding 13 A shall be provided with a plug according to DS 60884-2-D1. CLASS I EQUIPMENT provided with socket-outlets with earth contacts or which are intended to be used in locations where protection against indirect contact is required according to the wiring rules shall be provided with a plug in accordance with standard sheet DK 2-1a or DK 2-5a. If a single-phase equipment having a RATED CURRENT exceeding 13 A or if a poly-phase equipment is provided with a supply cord with a plug, this plug shall be in accordance with the standard sheets DK 6-1a in DS 60884-2-D1 or EN 60309-2. Justification the Heavy Current Regulations, 6c</p>	No supply cords provided.	N/A

IEC60950_1F - ATTACHMENT			
Clause	Requirement + Test	Result - Remark	Verdict
3.2.1.1	<p>In Spain, supply cords of single-phase equipment having a rated current not exceeding 10 A shall be provided with a plug according to UNE 20315:1994.</p> <p>Supply cords of single-phase equipment having a rated current not exceeding 2,5 A shall be provided with a plug according to UNE-EN 50075:1993.</p> <p>CLASS I EQUIPMENT provided with socket-outlets with earth contacts or which are intended to be used in locations where protection against indirect contact is required according to the wiring rules, shall be provided with a plug in accordance with standard UNE 20315:1994.</p> <p>If poly-phase equipment is provided with a supply cord with a plug, this plug shall be in accordance with UNE-EN 60309-2.</p>	No supply cords provided.	N/A
3.2.1.1	<p>In the United Kingdom, apparatus which is fitted with a flexible cable or cord and is designed to be connected to a mains socket conforming to BS 1363 by means of that flexible cable or cord and plug, shall be fitted with a 'standard plug' in accordance with Statutory Instrument 1768:1994 - The Plugs and Sockets etc. (Safety) Regulations 1994, unless exempted by those regulations.</p> <p>NOTE 'Standard plug' is defined in SI 1768:1994 and essentially means an approved plug conforming to BS 1363 or an approved conversion plug.</p>	No supply cords provided.	N/A
3.2.1.1	<p>In Ireland, apparatus which is fitted with a flexible cable or cord and is designed to be connected to a mains socket conforming to I.S. 411 by means of that flexible cable or cord and plug, shall be fitted with a 13 A plug in accordance with Statutory Instrument 525:1997 - National Standards Authority of Ireland (section 28) (13 A Plugs and Conversion Adaptors for Domestic Use) Regulations 1997.</p>	No supply cords provided.	N/A
3.2.4	<p>In Switzerland, for requirements see 3.2.1.1 of this annex.</p>		N/A
3.2.5.1	<p>In the United Kingdom, a power supply cord with conductor of 1,25 mm² is allowed for equipment with a rated current over 10 A and up to and including 13 A.</p>	No supply cords provided.	N/A
3.3.4	<p>In the United Kingdom, the range of conductor sizes of flexible cords to be accepted by terminals for equipment with a RATED CURRENT of over 10 A up to and including 13 A is:</p> <ul style="list-style-type: none"> • 1,25 mm² to 1,5 mm² nominal cross-sectional area. 	No supply cords provided.	N/A

IEC60950_1F - ATTACHMENT			
Clause	Requirement + Test	Result - Remark	Verdict
4.3.6	In the United Kingdom , the torque test is performed using a socket outlet complying with BS 1363 part 1:1995, including Amendment 1:1997 and Amendment 2:2003 and the plug part of DIRECT PLUG-IN EQUIPMENT shall be assessed to BS 1363: Part 1, 12.1, 12.2, 12.3, 12.9, 12.11, 12.12, 12.13, 12.16 and 12.17, except that the test of 12.17 is performed at not less than 125 °C. Where the metal earth pin is replaced by an Insulated Shutter Opening Device (ISOD), the requirements of clauses 22.2 and 23 also apply.	Not direct plug-in equipment.	N/A
4.3.6	In Ireland , DIRECT PLUG-IN EQUIPMENT is known as plug similar devices. Such devices shall comply with Statutory Instrument 526:1997 - National Standards Authority of Ireland (Section 28) (Electrical plugs, plug similar devices and sockets for domestic use) Regulations, 1997.	Not direct plug-in equipment.	N/A
5.1.7.1	In Finland, Norway and Sweden TOUCH CURRENT measurement results exceeding 3,5 mA r.m.s. are permitted only for the following equipment: <ul style="list-style-type: none"> • STATIONARY PLUGGABLE EQUIPMENT TYPE A that <ul style="list-style-type: none"> is intended to be used in a RESTRICTED ACCESS LOCATION where equipotential bonding has been applied, for example, in a telecommunication centre; and has provision for a permanently connected PROTECTIVE EARTHING CONDUCTOR; and is provided with instructions for the installation of that conductor by a SERVICE PERSON; • STATIONARY PLUGGABLE EQUIPMENT TYPE B; • STATIONARY PERMANENTLY CONNECTED EQUIPMENT. 	Measured touch current not exceeding 3,5 mA r.m.s.	N/A
6.1.2.1 (A1:2010)	In Finland, Norway and Sweden , add the following text between the first and second paragraph of the compliance clause: If this insulation is solid, including insulation forming part of a component, it shall at least consist of either <ul style="list-style-type: none"> - two layers of thin sheet material, each of which shall pass the electric strength test below, or - one layer having a distance through insulation of at least 0,4 mm, which shall pass the electric strength test below. Alternatively for components, there is no distance through insulation requirements for the insulation consisting of an insulating compound completely filling the casing, so that CLEARANCES and CREEPAGE DISTANCES do not exist, if the component passes the electric strength test in accordance with the compliance clause below and	No connection to telecommunication networks.	N/A

IEC60950_1F - ATTACHMENT			
Clause	Requirement + Test	Result - Remark	Verdict
	<p>in addition</p> <ul style="list-style-type: none"> - passes the tests and inspection criteria of 2.10.11 with an electric strength test of 1,5 kV multiplied by 1,6 (the electric strength test of 2.10.10 shall be performed using 1,5 kV), and - is subject to ROUTINE TESTING for electric strength during manufacturing, using a test voltage of 1,5 kV. 		
	<p>It is permitted to bridge this insulation with an optocoupler complying with 2.10.5.4 b).</p> <p>It is permitted to bridge this insulation with a capacitor complying with EN 60384-14:2005, subclass Y2.</p> <p>A capacitor classified Y3 according to EN 60384-14:2005, may bridge this insulation under the following conditions:</p> <ul style="list-style-type: none"> - the insulation requirements are satisfied by having a capacitor classified Y3 as defined by EN 60384-14, which in addition to the Y3 testing, is tested with an impulse test of 2,5 kV defined in EN 60950-1:2006, 6.2.2.1; - the additional testing shall be performed on all the test specimens as described in EN 60384-14: - the impulse test of 2,5 kV is to be performed before the endurance test in EN 60384-14, in the sequence of tests as described in EN 60384-14. 		N/A
6.1.2.2	<p>In Finland, Norway and Sweden, the exclusions are applicable for PERMANENTLY CONNECTED EQUIPMENT, PLUGGABLE EQUIPMENT TYPE B and equipment intended to be used in a RESTRICTED ACCESS LOCATION where equipotential bonding has been applied, e.g. in a telecommunication centre, and which has provision for a permanently connected PROTECTIVE EARTHING CONDUCTOR and is provided with instructions for the installation of that conductor by a SERVICE PERSON.</p>	No connection to telecommunication networks.	N/A
7.2	<p>In Finland, Norway and Sweden, for requirements see 6.1.2.1 and 6.1.2.2 of this annex.</p> <p>The term TELECOMMUNICATION NETWORK in 6.1.2 being replaced by the term CABLE DISTRIBUTION SYSTEM.</p>	Not connected to cable distribution system.	N/A
7.3 (A11:2009)	<p>In Norway and Sweden, for requirements see 1.2.13.14 and 1.7.2.1 of this annex.</p>	Not connected to cable distribution system.	N/A

IEC60950_1F - ATTACHMENT			
Clause	Requirement + Test	Result - Remark	Verdict

**Annex ZD
(informative)**

IEC and CENELEC code designations for flexible cords

Type of flexible cord	Code designations	
	IEC	CENELEC
PVC insulated cords		
Flat twin tinsel cord	60227 IEC 41	H03VH-Y
Light polyvinyl chloride sheathed flexible cord	60227 IEC 52	H03VV-F H03VVH2-F
Ordinary polyvinyl chloride sheathed flexible cord	60277 IEC 53	H05VV-F H05VVH2-F
Rubber insulated cords		
Braided cord	60245 IEC 51	H03RT-F
Ordinary tough rubber sheathed flexible cord	60245 IEC 53	H05RR-F
Ordinary polychloroprene sheathed flexible cord	60245 IEC 57	H05RN-F
Heavy polychloroprene sheathed flexible cord	60245 IEC 66	H07RN-F
Cords having high flexibility		
Rubber insulated and sheathed cord	60245 IEC 86	H03RR-H
Rubber insulated, crosslinked PVC sheathed cord	60245 IEC 87	H03RV4-H
Crosslinked PVC insulated and sheathed cord	60245 IEC 88	H03V4V4-H

IEC60950_1F - ATTACHMENT			
Clause	Requirement + Test	Result - Remark	Verdict

CANADA NATIONAL DIFFERENCES Information technology equipment – Safety – Part 1: General requirements
Differences according to.....: CAN/CSA C22.2 No. 60950-1-07 + A1:2011 + A2: 2014

	Speial national conditions		
1.1.1	All equipment is to be designed to allow installation in accordance with the National Electrical Code (NEC), ANSI/NFPA 70, the Canadian Electrical Code (CEC), Part I, CAN/CSA C22.1, and when applicable, the National Electrical Safety Code, IEEE C2.		N/A
	Also, unless marked or otherwise identified, installation is allowed per the Standard for the Protection of Electronic Computer/Data-Processing Equipment, ANSI/NFPA 75.		N/A
1.1.2	Baby monitors are required to comply with ASTM F2951, Consumer Safety Specification for Baby Monitors		N/A
1.4.14	For Pluggable Equipment Type A, the protection in the installation is assumed to be 20A.		N/A
1.5.5	For lengths exceeding 3.05 m, external interconnecting flexible cord and cable assemblies are required to be a suitable cable type (e.g., DP, CL2) specified in the CEC/NEC.	No external cable provided.	N/A
	For lengths 3.05 m or less, external interconnecting flexible cord and cable assemblies that are not types specified in the CEC are required to have special construction features and identification markings.		N/A
1.7.1	Equipment for use on a.c. mains supply systems with a neutral and more than one phase conductor (e.g. 120/240 V, 3-wire) require a special marking format for electrical ratings.		N/A
	A voltage rating that exceeds an attachment plug cap rating is only permitted if it does not exceed the extreme operating conditions in Table 2 of CAN/CSA C22.2 No. 235, and		N/A
	- if it is part of a range that extends into the Table 2 "Normal Operating Conditions."		N/A
	A voltage rating is not be lower than the specified "Normal Operating Conditions," unless it is part of a range that extends into the "Normal Operating Conditions."		N/A

IEC60950_1F - ATTACHMENT			
Clause	Requirement + Test	Result - Remark	Verdict
1.7.7	Wiring terminals intended to supply Class 2 outputs in accordance with CEC Part 1 or NEC are marked with the voltage rating and "Class 2" or equivalent.	No wiring terminals.	N/A
	- Marking is located adjacent to the terminals		N/A
	- Marking is visible during wiring		N/A
2.5	Where a fuse is used to provide Class 2, Limited Power Source, or TNV current limiting, it shall not be operator-accessible unless it is not interchangeable.		N/A
2.6	Equipment with isolated ground (earthing) receptacles is required to comply with NEC 250.146(D) and CEC 10-112 and 10-906(8).		N/A
2.7.1	Suitable NEC/CEC branch circuit protection rated at the maximum circuit rating is provided for all standard supply outlets and receptacles (such as supplied in power distribution units) if the supply branch circuit protection is not suitable.	No such components provided.	N/A
	Power distribution transformers distributing power at 100 volts or more, and rated 10 kVA or more, provided with special transformer overcurrent protection.		N/A
3.2	Wiring methods (terminals, leads, etc.) used for the connection of the equipment to the mains is in accordance with the NEC/CEC.		N/A
3.2.1	Power supply cords are required to have attachment plugs rated not less than 125 percent of the rated current of the equipment.	No power supply cord provided.	N/A
3.2.1.2	Equipment connected to a centralized d.c. power system, and having one pole of the DC mains input terminal connected to the main protective earthing terminal in the equipment comply with special earthing, wiring, marking and installation instruction requirements.	No connection to a centralized d.c. power system.	N/A
3.2.3	Permanent connection of equipment to the mains supply by a power supply cord is not permitted, except for certain equipment, such as ATMs.		N/A
3.2.5	Power supply cords are no longer than 4.5 m in length.	No power supply cord provided.	N/A
	Minimum cord length is 1.5 m, with certain constructions such as external power supplies allowed to consider both input and output cord lengths into the requirement.		N/A
	Flexible power supply cords are compatible with Article 400 of the NEC, and Tables 11 and 12 of the CEC.		N/A
3.2.9	Permanently connected equipment have a suitable wiring compartment and wire bending space.		N/A

IEC60950_1F - ATTACHMENT			
Clause	Requirement + Test	Result - Remark	Verdict
3.3	Wiring terminals and associated spacings for field wiring connections comply with CSA C22.2 No. 0.		N/A
3.3.3	Wire binding screws are not permitted to attach conductors larger than 10 AWG (5.3 mm ²).		N/A
3.3.4	Terminals for permanent wiring, including protective earthing terminals, are suitable for Canadian/US wire gauge sizes, are		N/A
	- rated 125 percent of the equipment rating, and		N/A
	- are specially marked when specified (1.7.7).		N/A
3.3.5	First column of Table 3E revised to require "Smaller of the RATED CURRENT of the equipment or the PROTECTIVE CURRENT RATING of the circuit under consideration."		N/A
3.4.2	Motor control devices are provided for cord-connected equipment with a motor if the equipment is rated more than 12 A,	Equipment is not such a device.	N/A
	- or if the motor has a nominal voltage rating greater than 120 V		N/A
	- or is rated more than 1/3 hp (locked rotor current over 43 A)		N/A
3.4.8	Vertically-mounted disconnect switches and circuit breakers have the "on" position indicated by the handle in the up position.	No such devices incorporated.	N/A
3.4.11	For computer room applications, equipment with battery systems capable of supplying 750 VA for five minutes have a battery disconnect means that may be connected to the computer room remote power-off circuit.	Not such an application.	N/A
4.3.12	The maximum quantity of flammable liquid stored in equipment complies with NFPA 30.	No liquids.	N/A
4.3.13.5.1	Equipment with lasers meet the Canadian Radiation Emitting Devices Act, REDR C1370 and/or Code of Federal Regulations 21 CFR 1040, as applicable.	No lasers.	N/A
4.7	For computer room applications, automated information storage systems with combustible media greater than 0.76 m ³ (27 cu ft) have a provision for connection of either automatic sprinklers or a gaseous agent extinguishing system with an extended discharge.	Not such an application.	N/A
4.7.3.1	For computer room applications, enclosures with combustible material measuring greater than 0.9 m ² (10 sq ft) or a single dimension greater than 1.8 m (6 ft) have a flame spread rating of 50 or less.	Not such an application.	N/A
	For other applications, enclosures with the same dimensions require a flame spread rating of 200 or less.		N/A

IEC60950_1F - ATTACHMENT			
Clause	Requirement + Test	Result - Remark	Verdict
Annex H	Equipment that produces ionizing radiation comply with the Canadian Radiation Emitting Devices Act, REDR C1370 and/or Code of Federal Regulations, 21 CFR 1020, as applicable.	Equipment is not such a device.	N/A
	Other National Differences		
1.5.1	Some components and materials associated with the risk of fire, electric shock, or personal injury have component or material ratings in accordance with the applicable national (Canadian and/or U.S.) component or material standard requirements. These components include: attachment plugs, battery packs (rechargeable type, used with transportable equipment), cathode ray tubes, circuit breakers, communication circuit accessories, connectors (used for current interruption of non-LPS circuits), cord sets and power supply cords, direct plug-in equipment, enclosures (outdoor), flexible cords and cables, fuses (branch circuit), fuseholders, ground-fault current interrupters, industrial control equipment, insulating tape, interconnecting cables, lampholders, limit controls, printed wiring, protectors for communications circuits, receptacles, solid state controls, supplementary protectors, switches (including interlock switches), thermal cutoffs, thermostats, (multi-layer) transformer winding wire, transient voltage surge suppressors, tubing, wire connectors, and wire and cables.	Complied. See table 1.5.1	P
1.6.1.2	A circuit for connection to the DC Mains Supply is classified as either a SELV Circuit, TNV-2 Circuit or Hazardous Voltage Circuit depending on the maximum operating voltage of the supply.	No connection to the DC Mains Supply.	N/A
	This maximum operating voltage includes consideration of the battery charging "float voltage" associated with the intended supply system, regardless of the marked power rating of the equipment.		N/A
2.3.1	For TNV-2 and TNV-3 circuits with other than ringing signals and with voltages exceeding 42.4 V _{peak} or 60 V _{d.c.} , the maximum acceptable current through a 2000 ohm resistor (or greater) connected across the voltage source with other loads disconnected is 7.1 mA peak or 30 mA d.c. under normal operating conditions.	No TNV circuits.	N/A
2.3.2.1	In the event of a single fault between TNV and SELV circuits, the limits of 2.2.3 apply to SELV Circuits and accessible conductive parts.	No TNV circuits.	N/A
2.6.2	Equipment with functional earthing is required to be marked with the functional earthing symbol (IEC 60417-6092)		P

IEC60950_1F - ATTACHMENT			
Clause	Requirement + Test	Result - Remark	Verdict
2.6.3.4	Protective bonding conductors of non-standard protective bonding constructions (e.g., printed circuit traces) may be subjected to the additional limited short circuit test conditions specified.	The 200A limited short circuit test performed and passed. Test between AC Inlet earth pin and bonding terminal: The Grounding test 12V, 40A, 120 sec.: before short circuit: 8mΩ; after short circuit: 8mΩ	P
4.2.8.1	Enclosures around CRTs with a face diameter of 160 mm or more reduce the risk of injury due to the implosion of the CRT.	No CRTs.	N/A
4.3.2	Equipment with handles complies with special loading tests.	No handles.	N/A
4.3.8	Battery packs for both portable and stationary applications are required to comply with special component requirements.		N/A
5.1.8.3	Equipment intended to receive telecommunication ringing signals comply with a special touch current measurement tests.	No TNV	N/A
5.3.7	Internal (e.g., card cage) SELV circuit connectors and printed wiring board connectors that are accessible to the operator and that deliver power are overloaded.		N/A
	During abnormal operating testing, if a circuit is interrupted by the opening of a component, the test shall be repeated twice (three tests total) using new components as necessary		N/A
6.4	Equipment intended for connection to telecommunication network outside plant cable is protected against overvoltage from power line crosses in accordance with 6.4 and Annex NAC.	No TNV.	N/A
Annex EE	Articulated accessibility probe (Fig EE.3) is used for assessing accessibility to document/media shredders instead of the Figure 2A test finger.	Equipment is not such a device.	N/A
M.2	Continuous ringing signals up to 16 mA only are permitted if the equipment is subjected to special installation and performance restrictions.	No TNV.	N/A
Annex NAD	Equipment connected to a telecommunication and cable distribution networks and supplied with an earphone intended to be held against, or in the ear comply with special acoustic pressure requirements.	No TNV.	N/A

IEC60950_1F - ATTACHMENT			
Clause	Requirement + Test	Result - Remark	Verdict

ATTACHMENT TO TEST REPORT IEC 60950-1 FINLAND NATIONAL DIFFERENCES Information technology equipment – Safety – Part 1: General requirements			
Differences according to: EN 60950-1:2006/A11:2009/A1:2010			
Attachment Form No.: FI_ND_IEC60950_1C			
Attachment Originator: SGS Fimko Ltd			
Master Attachment: Date (2010-04)			
Copyright © 2010 IEC System for Conformity Testing and Certification of Electrical Equipment (IECEE), Geneva, Switzerland. All rights reserved.			

	National Differences		
General	See also Group Differences (EN 60950-1:2006/A11/A1)		
1.5.7.1	In Finland resistors bridging BASIC INSULATION in CLASS I PLUGGABLE EQUIPMENT TYPE A must comply with the requirements in 1.5.7.1. In addition when a single resistor is used, the resistor must withstand the resistor test in 1.5.7.2.		N/A
1.5.9.4	In Finland , the third dashed sentence is applicable only to equipment as defined in 6.1.2.2 of this annex.	No such construction.	N/A
1.7.2.1	In Finland , CLASS I PLUGGABLE EQUIPMENT TYPE A intended for connection to other equipment or a network shall, if safety relies on connection to protective earth or if surge suppressors are connected between the network terminals and accessible parts, have a marking stating that the equipment must be connected to an earthed mains socket-outlet. The marking text in in Finland shall be as follows: "Laitte on liitettävä suojakoskettimilla varustettuun pistorasiaan"		N/A
2.3.2	In Finland , there are additional requirements for the insulation. See 6.1.2.1 and 6.1.2.2 of this annex.	No TNV.	N/A
2.10.5.13	In Finland , there are additional requirements for the insulation, see 6.1.2.1 and 6.1.2.2 of this annex.	No TNV.	N/A

IEC60950_1F - ATTACHMENT			
Clause	Requirement + Test	Result - Remark	Verdict
5.1.7.1	<p>In Finland, TOUCH CURRENT measurement results exceeding 3,5 mA r.m.s. are permitted only for the following equipment:</p> <ul style="list-style-type: none"> • STATIONARY PLUGGABLE EQUIPMENT TYPE A that <ul style="list-style-type: none"> - is intended to be used in a RESTRICTED ACCESS LOCATION where equipotential bonding has been applied, for example, in a telecommunication centre; and - has provision for a permanently connected PROTECTIVE EARTHING CONDUCTOR; and - is provided with instructions for the installation of that conductor by a SERVICE PERSON; • STATIONARY PLUGGABLE EQUIPMENT TYPE B; • STATIONARY PERMANENTLY CONNECTED EQUIPMENT. 	Not exceed 3.5mA.	N/A
6.1.2.1 (A1:2010)	<p>In Finland, add the following text between the first and second paragraph of the compliance clause:</p> <p>If this insulation is solid, including insulation forming part of a component, it shall at least consist of either</p> <ul style="list-style-type: none"> - two layers of thin sheet material, each of which shall pass the electric strength test below, or - one layer having a distance through insulation of at least 0,4 mm, which shall pass the electric strength test below. <p>Alternatively for components, there is no distance through insulation requirement for the insulation consisting of an insulating compound completely filling the casing, so that CLEARANCES and CREEPAGE DISTANCES do not exist, if the component passes the electric strength test in accordance with the compliance clause below and in addition</p> <ul style="list-style-type: none"> - passes the tests and inspection criteria of 2.10.11 with an electric strength test of 1,5 kV multiplied by 1,6 (the electric strength test of 2.10.10 shall be performed using 1,5 kV), and - is subject to ROUTINE TESTING for electric strength during manufacturing, using a test voltage of 1,5 kV. 	No TNV.	N/A

IEC60950_1F - ATTACHMENT			
Clause	Requirement + Test	Result - Remark	Verdict
	<p>It is permitted to bridge this insulation with an optocoupler complying with 2.10.5.4 b).</p> <p>It is permitted to bridge this insulation with a capacitor complying with EN 60384-14:2005, subclass Y2.</p> <p>A capacitor classified Y3 according to EN 60384-14:2005, may bridge this insulation under the following conditions:</p> <ul style="list-style-type: none"> - the insulation requirements are satisfied by having a capacitor classified Y3 as defined by EN 60384-14:2005 which in addition to the Y3 testing, is tested with an impulse test of 2,5 kV defined in EN 60950-1:2006, 6.2.2.1; - the additional testing shall be performed on all the test specimens as described in EN 60384-14:2005; - the impulse test of 2,5 kV is to be performed before the endurance test in EN 60384-14:2005, in the sequence of tests as described in EN 60384-14:2005. 		
6.1.2.2	<p>In Finland, the exclusions are applicable for PERMANENTLY CONNECTED EQUIPMENT, PLUGGABLE EQUIPMENT TYPE B and equipment intended to be used in a RESTRICTED ACCESS LOCATION where equipotential bonding has been applied, e.g. in a telecommunication centre, and which has provision for a permanently connected PROTECTIVE EARTHING CONDUCTOR and is provided with instructions for the installation of that conductor by a SERVICE PERSON.</p>	No TNV.	N/A
7.2	<p>In Finland, for requirements see 6.1.2.1 and 6.1.2.2 of this annex.</p> <p>The term TELECOMMUNICATION NETWORK in 6.1.2 being replaced by the term CABLE DISTRIBUTION SYSTEM.</p>	Not connected to cable distribution system.	N/A

IEC60950_1F - ATTACHMENT			
Clause	Requirement + Test	Result - Remark	Verdict

<p>ATTACHMENT TO TEST REPORT IEC 60950-1 GERMANY NATIONAL DIFFERENCES Information technology equipment – Safety – Part 1: General requirements</p>			
Differences according to.....: VDE 0805-1:2011-01			

Annex ZC, 1.7.2.1	According to GPSG, section 2, clause 4: If certain rules on the use, supplementation or maintenance of an item of technical work equipment or ready-to-use commodity must be observed in order to guarantee safety and health, instructions for use in German must be supplied when it is brought into circulation.		N/A
----------------------	--	--	------------

IEC60950_1F - ATTACHMENT			
Clause	Requirement + Test	Result - Remark	Verdict

**ATTACHMENT TO TEST REPORT IEC 60950-1
ISRAEL NATIONAL DIFFERENCES**

Information technology equipment – Safety –

Part 1: General requirements

Differences according to.....: SI 60950 Part 1

1.1.1	Replace the the text of Note 3 as follows: The requirements of Israel Standard SI 60065 may also be used to meet safety requirements for multimedia equipment. See IEC Guide 112, Guide on the safety of multimedia equipment.	Replaced.	P
1.6	The clause is applicable with the following addition:		N/A
1.6.1	Add following note: In Israel, this clause is applicable subject to the Electricity Law, 1954, its regulations and revisions.	Added	N/A
1.7	The clause is applicable with the following additions: Subclause 1.7.201 shall be added at the beginning of the clause as follows:	Added	N/A
1.7.201	Marking in the Hebrew language The marking in the Hebrew language shall be in accordance with the Consumer Protection Order (Marking of goods), 1983. In addition to the marking required by clause 1.7.1, the following details shall be marked in the Hebrew language. The details shall be marked on the apparatus or on its package, or on a label properly attached to the apparatus or on the package, by bonding or sewing, in a manner that the label cannot be easily removed. 1. Name of the apparatus and it commercial designation; 2. Manufacturer's name and address. If the apparatus is imported, the importer's name and address; 3. Manufacturer's registered trademark, if any; 4. Name of the model and serial number, if any; 5. Country of manufacture.		N/A
1.7.2.1	The following shall be added to the clause: All the instructions and warnings related to safety shall also be written in the Hebrew language.	Added	N/A
2	The clause is applicable with the following additions:		P

IEC60950_1F - ATTACHMENT			
Clause	Requirement + Test	Result - Remark	Verdict
2.9.4	<p>The following shall be added at the beginning of the clause:</p> <p>In Israel, according to the Electricity Law, 1954, and the Electricity Regulations (Earthing and means of protection against electricity of voltages up to 1,000V) 1991, seven means of protection against electrocution are permitted, as follows:</p> <ol style="list-style-type: none"> 1) TN-S - Network system earthing; TN-C-S - Network system earthing; 2) TT - Network system earthing; 3) IT - Network Insulation Terre; 4) Isolated transformer; 5) Safety extra low voltage (SELV or ELV); 6) Residual current circuit breaker (30 mA = IΔ); 7) Reinforced insulation; Double insulation (class II) 	Added.	P
2.201	<p>Prevention of electromagnetic interference</p> <p>- Prior to carrying out the tests in accordance with the clauses of this Standard, the compliance of the apparatus with the relevant requirements specified in the appropriate part of the Standard series, SI 961, shall be checked.</p> <p><u>The apparatus shall meet the requirements in the appropriate part of the Standard series, SI 961.</u></p> <p>- If there are components in the apparatus for the prevention of electromagnetic interference, these components shall not reduce the safety level of the apparatus as required by this Standard.</p>		N/A
3	The clause is applicable with the following additions:		
3.2.1.1	<p>Connection to an a.c. mains supply</p> <p>After the note, the following note shall be added:</p> <p>Note:</p> <p>In Israel, the feed plug shall comply with the requirements of Israel Standard SI 32 Part 1.1.</p>	No feed plug provided.	N/A
3.2.1.2	<p>Connection to a d.c. mains supply</p> <p>At the end of the first paragraph, the following note shall be added:</p> <p>Note:</p> <p>At the time of issue of this Standard, there is no Israel Standard for connection accessories to d.c.</p>	No connected to d.c. mains supply	N/A
Annex P	<p>Normative references</p> <p>(List of relevant Israel Standards that have been inserted in place of some of the International Standards)</p>	Inserted	P

IEC60950_1F - ATTACHMENT			
Clause	Requirement + Test	Result - Remark	Verdict

ATTACHMENT TO TEST REPORT IEC 60950-1 KOREA NATIONAL DIFFERENCES Information technology equipment – Safety – Part 1: General requirements			
Differences according to.....: K 60950-1			

1.5.101	Plugs for the connection of the apparatus to the supply mains shall comply with the Korean requirement (KSC 8305)	No power supply cord provided.	N/A
8	EMC The apparatus shall comply with the relevant CISPR standards.		N/A

IEC60950_1F - ATTACHMENT			
Clause	Requirement + Test	Result - Remark	Verdict

ATTACHMENT TO TEST REPORT IEC 60950-1 with A1: 2009 and A2:2013 U.S.A. NATIONAL DIFFERENCES Information technology equipment – Safety – Part 1: General requirements	
Differences according to	UL 60950-1-07(Second Edition) + A1: 2011 + A2: 2014
Attachment Form No.....	US_ND_IEC60950_1F
Attachment Originator	UL
Master Attachment	Date 2014-07
Copyright © 2014 IEC System for Conformity Testing and Certification of Electrical Equipment (IECEE), Geneva, Switzerland. All rights reserved.	

	Special national conditions		
1.1.1	All equipment is designed as to allow installation in accordance with the National Electrical Code (NEC), ANSI/NFPA 70, Canadian Electrical Code (CEC), Part I, CAN/CSA C22.1, and if applicable, the National Electrical Safety Code, IEEE C2	In accordance with the National Electrical Code (NEC), ANSI/NFPA 70, and unless marked or otherwise identified, the Standard for Electronic Computer/Data-Processing Equipment, ANSI/NFPA 75.	P
	Also, unless marked or otherwise identified, installation is allowed per the Standard for the Protection of Electronic Computer/Data-Processing Equipment, ANSI/NFPA 75		P
1.1.2	Baby monitors are required to additionally comply with ASTM F2951, Consumer Safety Specification for Baby Monitors		N/A
1.4.14	For Pluggable Equipment Type A, the protection in the installation is assumed to be 20A	Considered.	P
1.5.5	For lengths exceeding 3.05 m, external interconnecting flexible cord and cable assemblies are required to be a suitable cable type (e.g., DP, CL2) specified in the /NEC	No external cable provided.	N/A
	For lengths 3.05 m or less, external interconnecting flexible cord and cable assemblies that are not types specified in the NEC are required to have special construction features and identification markings		N/A
1.7.1	Equipment for use on a.c. mains supply systems with a neutral and more than one phase conductor (e.g. 120/240 V, 3-wire) require a special marking format for electrical ratings	Single-phase equipment.	N/A
	A voltage rating that exceeds an attachment plug cap rating is only permitted if it does not exceed the extreme operating conditions in Table 2 of CAN/CSA C22.2 No. 235, and		N/A
	- if it is part of a range that extends into the Table 2 "Normal Operating Conditions"		N/A

IEC60950_1F - ATTACHMENT			
Clause	Requirement + Test	Result - Remark	Verdict
	Likewise, a voltage rating is not to be lower than the specified "Normal Operating Conditions," unless it is part of a range that extends into the "Normal Operating Conditions"		N/A
1.7.7	Wiring terminals intended to supply Class 2 outputs in accordance with NEC or CEC Part 1 or NEC are marked with the voltage rating and "Class 2" or equivalent	No wiring terminals.	N/A
	- Marking is located adjacent to the terminals		N/A
	- Marking is visible during wiring		N/A
2.5	Fuse providing Class 2, Limited Power Source, or TNV current limiting is not operator-accessible unless it is not interchangeable	Not operator-accessible.	P
2.6	Equipment with isolated ground (earthing) receptacles is in compliance with NEC 250.146(D) and CEC 10-112 and 10-906(8)		N/A
2.7.1	Suitable NEC/CEC branch circuit protection rated at the maximum circuit rating is provided for all standard supply outlets and receptacles (such as supplied in power distribution units) if the supply branch circuit protection is not suitable.	No such components provided.	N/A
	Power distribution transformers distributing power at 100 volts or more, and rated 10 kVA or more, provided with special transformer overcurrent protection		N/A
3.2	Wiring methods (terminals, leads, etc.) used for the connection of the equipment to the mains is in accordance with the NEC/CEC		N/A
3.2.1	Attachment plugs of power supply cords are rated not less than 125 percent of the rated current of the equipment		N/A
3.2.1.2	Equipment connected to a centralized d.c. power system, and having one pole of the DC mains input terminal connected to the main protective earthing terminal in the equipment comply with special earthing, wiring, marking and installation instruction requirements	No power supply cord provided.	N/A
3.2.3	Permanent connection of equipment to the mains supply by a power supply cord is not permitted, except for certain equipment, such as ATMs	No connection to a centralized d.c. power system.	N/A
3.2.5	Power supply cords are no longer than 4.5 m in length	Pluggable equipment type A.	N/A
	Minimum cord length is 1.5 m, with certain constructions such as external power supplies allowed to consider both input and output cord lengths into the requirement		N/A

IEC60950_1F - ATTACHMENT			
Clause	Requirement + Test	Result - Remark	Verdict
	Flexible power supply cords are compatible with Article 400 of the NEC, and Tables 11 and 12 of the CEC		N/A
3.2.9	Permanently connected equipment has a suitable wiring compartment and wire bending space	Pluggable equipment type A.	N/A
3.3	Wiring terminals and associated spacings for field wiring connections comply with CSA C22.2 No. 0	No wiring terminals.	N/A
3.3.3	Wire binding screws are not attached with conductors larger than 10 AWG (5.3 mm ²)	No wire binding screws.	N/A
3.3.4	Terminals for permanent wiring, including protective earthing terminals, are suitable for Canadian/US wire gauge sizes, are	Pluggable equipment type A.	N/A
	- rated 125 per cent of the equipment rating, and		N/A
	- are specially marked when specified (1.7.7)		N/A
3.3.5	Revise first column of Table 3E to "Smaller of the RATED CURRENT of the equipment or the PROTECTIVE CURRENT RATING of the circuit under consideration"	Considered.	P
3.4.2	Motor control devices are provided for cord-connected equipment with a motor if the equipment is rated more than 12 A,	Equipment is not such a device.	N/A
	- or if the motor has a nominal voltage rating greater than 120 V		N/A
	- or is rated more than 1/3 hp (locked rotor current over 43 A)		N/A
3.4.8	Vertically-mounted disconnect switches and circuit breakers have the "on" position indicated by the handle in the up position	No such devices incorporated.	N/A
3.4.11	For computer room applications, equipment with battery systems capable of supplying 750 VA for five minutes have a battery disconnect means that may be connected to the computer room remote power-off circuit	Not such an application.	N/A
4.3.12	The maximum quantity of flammable liquid stored in equipment complies with NFPA 30	No liquids.	N/A
4.3.13.5.1	Equipment with lasers meets the U.S. Code of Federal Regulations 21 CFR 1040 (and the Canadian Radiation Emitting Devices Act, REDR C1370).	No lasers.	N/A
4.7	For computer room applications, automated information storage systems with combustible media greater than 0.76 m ³ (27 cu ft) have a provision for connection of either automatic sprinklers or a gaseous agent extinguishing system with an extended discharge	Not such an application.	N/A
4.7.3.1	For computer room applications, enclosures with combustible material measuring greater than 0.9m ² (10 sq ft) or a single dimension greater than 1.8 m (6 ft) have a flame spread rating of 50 or less	Not such an application.	N/A

IEC60950_1F - ATTACHMENT			
Clause	Requirement + Test	Result - Remark	Verdict
	For other applications, enclosures with the same dimensions require a flame spread rating of 200 or less		N/A
4.7.3.1	Non-metallic enclosures of equipment for use in spaces used for environmental air (plenums) are required to comply with UL 2043		N/A
Annex H	Equipment that produces ionizing radiation complies with U.S. Code of Federal Regulations, 21 CFR 1020 (and the Canadian Radiation Emitting Devices Act, REDR C1370)	Equipment is not such a device.	N/A
Other National Differences			
1.5.1	Some components and materials associated with the risk of fire, electric shock, or personal injury have component or material ratings in accordance with the applicable national (Canadian and/or U.S.) component or material standard requirements. These components include: attachment plugs, battery backup systems, battery packs, cathode ray tubes, circuit breakers, communication circuit accessories, connectors (used for current interruption of non-LPS circuits), cord sets and power supply cords, direct plug-in equipment, electrochemical capacitor modules (energy storage modules with ultracapacitors), enclosures (outdoor), flexible cords and cables, fuses (branch circuit), fuseholders, ground-fault current interrupters, industrial control equipment, insulating tape, interconnecting cables, lampholders, limit controls, printed wiring, protectors for communications circuits, receptacles, solid state controls, supplementary protectors, switches (including interlock switches), thermal cut-offs, thermostats, (multi-layer) transformer winding wire, surge protective devices, tubing, vehicle battery adapters, wire connectors, and wire and cables	Complied. See table 1.5.1	P
1.6.1.2	A circuit for connection to the DC Mains Supply is classified as a SELV Circuit, TNV-2 Circuit or Hazardous Voltage Circuit depending on the maximum operating voltage of the supply	No connection to the DC Mains Supply.	N/A
	This maximum operating voltage includes consideration of the battery charging "float voltage" associated with the intended supply system, regardless of the marked power rating of the equipment		N/A
2.3.1	For TNV-2 and TNV-3 circuits with other than ringing signals and with voltages exceeding $42.4 V_{peak}$ or 60 Vd.c., the maximum acceptable current through a 2000 ohm resistor (or greater) connected across the voltage source with other loads disconnected is 7.1 mA peak or 30 mA d.c. under normal operating conditions	No TNV circuits.	N/A

IEC60950_1F - ATTACHMENT			
Clause	Requirement + Test	Result - Remark	Verdict
2.3.2.1	In the event of a single fault between TNV and SELV circuits, the limits of 2.2.3 apply to SELV Circuits and accessible conductive parts	No TNV circuits.	N/A
2.6.2	Equipment with functional earthing marked with the functional earthing symbol (IEC 60417-6092)		N/A
2.6.3.4	Protective bonding conductors of non-standard protective bonding constructions (e.g., printed circuit traces) may be subjected to the additional limited short circuit test conditions specified	The 200A limited short circuit test performed and passed. Test between AC Inlet earth pin and bonding terminal: The Grounding test 12V, 40A, 120 sec.: before short circuit: 8mΩ; after short circuit: 8mΩ	P
4.2.8.1	Enclosures around CRTs with a face diameter of 160 mm or more reduce the risk of injury due to the implosion of the CRT	No CRTs.	N/A
4.3.2	Equipment with handles complies with special loading tests	No handles.	N/A
4.3.8	Battery packs for both portable and stationary applications comply with special component requirements		N/A
5.1.8.3	Equipment intended to receive telecommunication ringing signals comply with a special touch current measurement tests	No TNV.	N/A
5.3.7	Internal (e.g., card cage) SELV circuit connectors and printed wiring board connectors that are accessible to the operator and that deliver power are overloaded		N/A
	During abnormal operating testing, if a circuit is interrupted by the opening of a component, the test is repeated twice (three tests total) using new components as necessary		N/A
6.4	Equipment intended for connection to telecommunication network outside plant cable is protected against overvoltage from power line crosses in accordance with 6.4 and Annex NAC	No TNV.	N/A
Annex EE	Articulated accessibility probe (Fig EE.3) is used for assessing accessibility to document/media shredders instead of the Figure 2A test finger	No document (paper) shredder.	N/A
Annex M.2	Continuous ringing signals up to 16 mA only are permitted if the equipment is subjected to special installation and performance restrictions	No TNV.	N/A
Annex NAD	Equipment connected to a telecommunication and cable distribution networks and supplied with an earphone intended to be held against, or in the ear comply with special acoustic pressure requirements	No TNV.	N/A

IEC60950_1F - ATTACHMENT			
Clause	Requirement + Test	Result - Remark	Verdict

**ATTACHMENT TO TEST REPORT IEC 60950-1
AUSTRALIA and NEW ZEALAND NATIONAL DIFFERENCES**

Information technology equipment – Safety –
Part 1: General requirements

Differences according to.....: AS/NZS 60950.1:2011 and Amendment No. 1
To AS/NZS 60950.1:2011

1.2	Insert the following between 'person, service' and 'range, rated frequency': POTENTIAL IGNITION SOURCE 1.2.12		N/A
1.2.12.201	Insert a new Clause 1.2.12.201 after Clause 1.2.12.15 as follows: 1.2.12.201 POTENTIAL IGNITION SOURCE Possible fault which can start a fire if the open-circuit voltage measured across an interruption or faulty contact exceeds a value of 50 V (peak) a.c. or d.c. and the product of the peak value of this voltage and the measured r.m.s. current under normal operating conditions exceeds 15 VA. Such a faulty contact or interruption in an electrical connection includes those which may occur in CONDUCTIVE PATTERNS on PRINTED BOARDS. NOTE 201 An electronic protection circuit may be used to prevent such a fault from becoming a POTENTIAL IGNITION SOURCE. NOTE 202 This definition is from AS/NZS 60065:2003.		N/A
1.5.1	1. Add the following to the end of the first paragraph: 'or the relevant Australian/New Zealand Standard.' 2. In NOTE 1, add the following after the word 'standard': 'or an Australian/New Zealand Standard'	Added.	P
1.5.2	Add the following to the end of the first and third dash items: 'or the relevant Australian/New Zealand Standard'	Added.	P

IEC60950_1F - ATTACHMENT																				
Clause	Requirement + Test	Result - Remark	Verdict																	
3.2.5.1	<p>Modify Table 3B as follows:</p> <p>1. Delete the first four rows and replace with the following:</p> <table border="1"> <thead> <tr> <th rowspan="2">RATED CURRENT of equipment A</th> <th colspan="2">Minimum conductor sizes</th> </tr> <tr> <th>Nominal cross-sectional area mm²</th> <th>AWG or kcmil [cross-sectional area in mm²] see Note 2</th> </tr> </thead> <tbody> <tr> <td>Over 0.2 up to and including 3</td> <td>0,5 ^a</td> <td>18 [0,8]</td> </tr> <tr> <td>Over 3 up to and including 7.5</td> <td>0,75</td> <td>16 [1,3]</td> </tr> <tr> <td>Over 7.5 up to and including 10</td> <td>(0,75) ^b 1,00</td> <td>16 [1,3]</td> </tr> <tr> <td>Over 10 up to and including 16</td> <td>(1,0) ^c 1,5</td> <td>14 [2]</td> </tr> </tbody> </table> <p>2. Delete NOTE 1.</p> <p>3. Delete Footnote ^a and replace with the following: ^a This nominal cross-sectional area is only allowed for Class II appliances if the length of the power supply cord, measured between the point where the cord, or cord guard, enters the appliance, and the entry to the plug does not exceed 2 m (0,5 mm² three-core supply flexible cords are not permitted; see AS/NZS 3191).</p>	RATED CURRENT of equipment A	Minimum conductor sizes		Nominal cross-sectional area mm ²	AWG or kcmil [cross-sectional area in mm ²] see Note 2	Over 0.2 up to and including 3	0,5 ^a	18 [0,8]	Over 3 up to and including 7.5	0,75	16 [1,3]	Over 7.5 up to and including 10	(0,75) ^b 1,00	16 [1,3]	Over 10 up to and including 16	(1,0) ^c 1,5	14 [2]	Replaced.	N/A
RATED CURRENT of equipment A	Minimum conductor sizes																			
	Nominal cross-sectional area mm ²	AWG or kcmil [cross-sectional area in mm ²] see Note 2																		
Over 0.2 up to and including 3	0,5 ^a	18 [0,8]																		
Over 3 up to and including 7.5	0,75	16 [1,3]																		
Over 7.5 up to and including 10	(0,75) ^b 1,00	16 [1,3]																		
Over 10 up to and including 16	(1,0) ^c 1,5	14 [2]																		
4.1.201	<p>Insert a new Clause 4.1.201 after Clause 4.1 as follows:</p> <p>4.1.201 Display devices used for television purposes</p> <p>Display devices which may be used for television purposes, with a mass of 7 kg or more, shall comply with the requirements for stability and mechanical hazards, including the additional stability requirements for television receivers, specified in AS/NZS 60065.</p>	No such device.	N/A																	
4.3.6	<p>Delete the third paragraph and replace with the following:</p> <p><i>Equipment with a plug portion, suitable for insertion into a 10 A 3-pin flatpin socket-outlet complying with AS/NZS 3112 shall comply with the requirements in AS/NZS 3112 for equipment with integral pins for insertion into socket-outlets.</i></p>		N/A																	
4.3.13.5.1	<p>Add the following to the end of the first paragraph: 'or AS/NZS 2211.1'</p>	Added.	N/A																	

IEC60950_1F - ATTACHMENT			
Clause	Requirement + Test	Result - Remark	Verdict
4.7	Add the following new paragraph to the end of the clause: 'For alternate tests refer to Clause 4.7.201.'	Added.	P
4.7.201	Insert a new Clause 4.7.201 after Clause 4.7.3.6 as follows: 4.7.201 Resistance to fire – Alternative tests	Added. Alternative tests not applied for	N/A
4.7.201.1	<p>4.7.201.1 General</p> <p>Parts of non-metallic material shall be resistant to ignition and spread of fire.</p> <p>This requirement does not apply to decorative trims, knobs and other parts unlikely to be ignited or to propagate flames from inside the apparatus, or the following:</p> <p>(a) Components that are contained in an enclosure having a flammability category of V-0 according to AS/NZS 60695.11.10 and having openings only for the connecting wires filling the openings completely, and for ventilation not exceeding 1mm in width regardless of length.</p> <p>(b) The following parts which would contribute negligible fuel to a fire:</p> <ul style="list-style-type: none"> - small mechanical parts, the mass of which does not exceed 4g, such as mounting parts, gears, cams, belts and bearings; - small electrical components, such as capacitors with a volume not exceeding 1,750 mm³, integrated circuits, transistors and optocoupler packages, if these components are mounted on material of flammability category V-1, or better, according to AS/NZS 60695.11.10. <p>NOTE In considering how to minimize propagation of fire and what 'small parts' are, account should be taken of the cumulative effect of small parts adjacent to each other for the possible effect of propagating the fire from one part to another.</p> <p>Compliance shall be checked by the tests of 4.7.201.2, 4.7.201.3, 4.7.201.4 and 4.7.201.5.</p> <p>For the base material of printed boards, compliance shall be checked by the test of 4.7.201.5.</p> <p>The tests shall be carried out on parts of non-metallic material which have been removed from the apparatus. When the glow-wire test is carried out, the parts shall be placed in the same orientation as they would be in normal use.</p> <p>These tests are not carried out on internal wiring.</p>		N/A

IEC60950_1F - ATTACHMENT									
Clause	Requirement + Test	Result - Remark	Verdict						
4.7.201.2	<p>4.7.201.2 Testing of non-metallic materials</p> <p>Parts of non-metallic material shall be subject to the glow-wire test of AS/NZS 60695.2.11 which shall be carried out at 550 °C.</p> <p>Parts for which the glow-wire test cannot be carried out, such as those made of soft or foamy material, shall meet the requirements specified in ISO 9772 for category FH-3 material. The glow-wire test shall be not carried out on parts of material classified at least FH-3 according to ISO 9772 provided that the sample tested was not thicker than the relevant part.</p>		N/A						
4.7.201.3	<p>4.7.201.3 Testing of insulating materials</p> <p>Parts of insulating material supporting POTENTIAL IGNITION SOURCES shall be subject to the glow-wire test of AS/NZS 60695.2.11 which shall be carried out at 750 °C.</p> <p>The test shall be also carried out on other parts of insulating material which are within a distance of 3 mm of the connection.</p> <p>NOTE Contacts in components such as switch contacts are considered to be connections.</p> <p>For parts which withstand the glow-wire test but produce a flame, other parts above the connection within the envelope of a vertical cylinder having a diameter of 20 mm and a height of 50 mm shall be subjected to the needle-flame test. However, parts shielded by a barrier which meets the needle-flame test shall not be tested.</p> <p>The needle-flame test shall be made in accordance with AS/NZS 60695.11.5 with the following modifications:</p> <table border="1"> <tr> <td>Clause of AS/NZS 60695.11.5</td> <td>Change</td> </tr> <tr> <td colspan="2">9 Test procedure</td> </tr> <tr> <td>9.2 Application of needleflame</td> <td> <p>Replace the first paragraph with:</p> <p>The specimen shall be arranged so that the flame can be applied to a vertical or horizontal edge as shown in the examples of figure 1. If possible the flame shall be applied at least 10 mm from a corner</p> <p>Replace the second paragraph with:</p> <p>The duration of application of the test flame shall be 30 s</p> </td> </tr> </table>	Clause of AS/NZS 60695.11.5	Change	9 Test procedure		9.2 Application of needleflame	<p>Replace the first paragraph with:</p> <p>The specimen shall be arranged so that the flame can be applied to a vertical or horizontal edge as shown in the examples of figure 1. If possible the flame shall be applied at least 10 mm from a corner</p> <p>Replace the second paragraph with:</p> <p>The duration of application of the test flame shall be 30 s</p>		N/A
Clause of AS/NZS 60695.11.5	Change								
9 Test procedure									
9.2 Application of needleflame	<p>Replace the first paragraph with:</p> <p>The specimen shall be arranged so that the flame can be applied to a vertical or horizontal edge as shown in the examples of figure 1. If possible the flame shall be applied at least 10 mm from a corner</p> <p>Replace the second paragraph with:</p> <p>The duration of application of the test flame shall be 30 s</p>								

IEC60950_1F - ATTACHMENT									
Clause	Requirement + Test	Result - Remark	Verdict						
	<table border="1"> <tr> <td></td> <td>±1 s.</td> </tr> <tr> <td>9.3 Number of test specimens</td> <td>Replace with: The test shall be made on one specimen. If the specimen does not withstand the test, the test may be repeated on two further specimens, both of which shall withstand the test.</td> </tr> <tr> <td>11 Evaluation of test results</td> <td>Replace with: The duration of burning (t_b) shall not exceed 30 s. However, for printed circuit boards, it shall not exceed 15 s.</td> </tr> </table> <p>The needle-flame test shall not be carried out on parts of material classified as V-0 or V-1 according to AS/NZS 60695.11.10, provided that the sample tested was not thicker than the relevant part.</p>		±1 s.	9.3 Number of test specimens	Replace with: The test shall be made on one specimen. If the specimen does not withstand the test, the test may be repeated on two further specimens, both of which shall withstand the test.	11 Evaluation of test results	Replace with: The duration of burning (t_b) shall not exceed 30 s. However, for printed circuit boards, it shall not exceed 15 s.		
	±1 s.								
9.3 Number of test specimens	Replace with: The test shall be made on one specimen. If the specimen does not withstand the test, the test may be repeated on two further specimens, both of which shall withstand the test.								
11 Evaluation of test results	Replace with: The duration of burning (t_b) shall not exceed 30 s. However, for printed circuit boards, it shall not exceed 15 s.								
4.7.201.4	<p>4.7.201.4 Testing in the event of non-extinguishing material</p> <p>If parts, other than enclosures, do not withstand the glow wire tests of 4.7.201.3, by failure to extinguish within 30 s after the removal of the glowwire tip, the needle-flame test detailed in 4.7.201.3 shall be made on all parts of non-metallic material which are within a distance of 50 mm or which are likely to be impinged upon by flame during the tests of 4.7.201.3. Parts shielded by a separate barrier which meets the needle-flame test need not be tested.</p> <p>NOTE 1 If the enclosure does not withstand the glow-wire test the equipment is considered to have failed to meet the requirements of Clause 4.7.201 without the need for consequential testing.</p> <p>NOTE 2 If other parts do not withstand the glow-wire test due to ignition of the tissue paper and if this indicates that burning or glowing particles can fall onto an external surface underneath the equipment, the equipment is considered to have failed to meet the requirements of Clause 4.7.201 without the need for consequential testing.</p> <p>NOTE 3 Parts likely to be impinged upon by the flame are considered to be those within the envelope of a vertical cylinder having a radius of 10 mm and a height equal to the height of the flame, positioned above the point of the material supporting, in contact with, or in close proximity to, connections.</p>		N/A						
4.7.201.5	<p>4.7.201.5 Testing of printed boards</p> <p>The base material of printed boards shall be subjected to the needle-flame test of Clause 4.7.201.3. The flame shall be applied to the edge of the board where the heat sink effect is lowest</p>		N/A						

IEC60950_1F - ATTACHMENT			
Clause	Requirement + Test	Result - Remark	Verdict
	<p>when the board is positioned as in normal use. The flame shall not be applied to an edge, consisting of broken perforations, unless the edge is less than 3 mm from a POTENTIAL IGNITION SOURCE.</p> <p>The test is not carried out if the —</p> <ul style="list-style-type: none"> - Printed board does not carry any POTENTIAL IGNITION SOURCE; - Base material of printed boards, on which the available apparent power at a connection exceeds 15 VA operating at a voltage exceeding 50 V and equal or less than 400 V (peak) a.c. or d.c. under normal operating conditions, is of flammability category V-1 or better according to AS/NZS 60695.11.10, or the printed boards are protected by an enclosure meeting the flammability category V-0 according to AS/NZS 60695.11.10, or made of metal, having openings only for connecting wires which fill the openings completely; or - Base material of printed boards, on which the available apparatus power at a connection exceeds 15 VA operating at a voltage exceeding 400 V (peak) a.c. or d.c. under normal operating conditions, and base material of printed boards supporting spark gaps which provides protection against overvoltages, is of flammability category V-0 according to AS/NZS 60695.11.10 or the printed boards are contained in a metal enclosure, having openings only for connecting wires which fill the openings completely. <p>Compliance shall be determined using the smallest thickness of the material.</p> <p>NOTE Available apparent power is the maximum apparent power which can be drawn from the supplying circuit through a resistive load whose value is chosen to maximise the apparent power for more than 2 min when the circuit supplied is disconnected.</p>		
6.2.2	<p>For Australia only, delete the first paragraph and Note, and replace with the following:</p> <p>In Australia only, compliance with 6.2.2 shall be checked by the tests of both 6.2.2.1 and 6.2.2.2.</p>	No TNV.	N/A

IEC60950_1F - ATTACHMENT			
Clause	Requirement + Test	Result - Remark	Verdict
6.2.2.1	<p>For Australia only, delete the first paragraph including the Notes, and replace with the following:</p> <p><i>In Australia only, the electrical separation is subjected to 10 impulses of alternating polarity, using the impulse test generator reference 1 of Table N.1. The interval between successive impulses is 60 s and the initial voltage, U_c, is:</i></p> <p><i>(i) for 6.2.1 a): 7.0 kV for hand-held telephones and for headsets and 2.5 kV for other equipment; and</i></p> <p><i>(ii) for 6.2.1 b) and 6.2.1 c): 1.5 kV.</i></p> <p>NOTE 201 The 7 kV impulse simulates lightning surges on typical rural and semi-rural network lines.</p> <p>NOTE 202 The value of 2.5 kV for 6.2.1 a) was chosen to ensure the adequacy of the insulation concerned and does not necessarily simulate likely overvoltages.</p>	No TNV.	N/A
6.2.2.2	<p>For Australia only, delete the second paragraph including the Note, and replace with the following:</p> <p><i>In Australia only, the a.c. test voltage is:</i></p> <p><i>(i) for 6.2.1 a): 3 kV; and</i></p> <p><i>(ii) for 6.2.1 b) and 6.2.1 c): 1.5 kV.</i></p> <p>NOTE 201 Where there are capacitors across the insulation under test, it is recommended that d.c. test voltages are used.</p> <p>NOTE 202 The 3 kV and 1.5 kV values have been determined considering the low frequency induced voltages from the power supply distribution system.</p>	No TNV.	N/A
7.3	<p>Add the following before the first paragraph:</p> <p>Equipment providing functions that fall only within the scope of AS/NZS 60065 and that incorporate a PSTN interface, are not required to comply with this Clause where the only ports provided on the equipment, in addition to a coaxial cable connection and a PSTN interface, are audio or video ports and analogue or data ports not intended to be used for telecommunications purposes.</p>	Not connected to cable distribution system.	N/A
Annex P	<p>Normative references</p> <p>(List of relevant Australia/New Zealand Standards that have been inserted in place of some of the International Standards)</p>	Added.	P

IEC60950_1F - ATTACHMENT			
Clause	Requirement + Test	Result - Remark	Verdict

J 60950-1(H27) TEST REPORT

(Deviations from IEC 60950-1:2005+A1:2009)

Special National conditions, National deviation and other information according to MITI Ordinance No. 85.

Japanese unique deviations in J60950-1(H27) (=JIS C 6950-1:2014)

1.2.4.1	<p>Replace the existing NOTE as NOTE 1, and add NOTE 2 as following:</p> <p>NOTE 2: Even if the equipment is designed as CLASS I EQUIPMENT, if a 2-pin plug adaptor with a protective earthing lead wire (adaptor which converts a plug for CLASS I EQUIPMENT to a 2-pin plug with no earthing contact) or a cord set having a 2-pin plug with a protective earthing lead wire is packed as accessory together with the equipment or if use of those is recommended to the users, the equipment is considered as CLASS 0I EQUIPMENT.</p>	Added.	P
1.2.4.3A	<p>Add 1.2.4.3A as following:</p> <p>1.2.4.3A CLASS 0I EQUIPMENT</p> <p>Equipment having a mains plug without earthing contact, which protection against electric shock is achieved by:</p> <ul style="list-style-type: none"> - using BASIC INSULATION; and - for the measures to connect conductive part(s) regarded as part at HAZARDIOUS VOLTAGE in the event of fault of BASIC INSULATION to PROTECTIVE EARTHING CONDUCTOR, equipping any one of the following: <ul style="list-style-type: none"> a) mains plug with a protective earthing lead wire, this includes the following cases: <ul style="list-style-type: none"> - where a 2-pin plug adaptor with a protective earthing lead wire is packed as accessory together with the equipment; or - where use of it is recommended. b) independent protective earthing terminal (see 2.6.5.8A) if the equipment uses a power supply cord of two conductors (exclude earthing conductor) <p>NOTE - CLASS 0I EQUIPMENT may have a part constructed with DOUBLE INSULATION or REINFORCED INSULATION.</p>	Added.	P

IEC60950_1F - ATTACHMENT			
Clause	Requirement + Test	Result - Remark	Verdict
1.3.2	<p>Add the following NOTES after first paragraph:</p> <p>NOTE 1 TRANSPORTABLE or similar equipment that are relocated frequently for intended usage it is recommended not to design as CLASS I or CLASS 0I EQUIPMENT unless it is intended to be installed by a SERVICE PERSON or installation personnel.</p> <p>NOTE 2 Considering wiring circumstance in Japan, equipment intended to be installed where the provision for earthing connection is unlikely should not be designed as CLASS I or CLASS 0I EQUIPMENT unless it is intended to be installed by a SERVICE PERSON or installation personnel.</p>	Added.	N/A
1.5.1	<p>Replace the first paragraph with the following:</p> <p>Where safety is involved, components shall comply either with the requirements of this standard, with the safety aspects of the relevant JIS component standards, or IEC component standards in case there is no applicable JIS component standard available. However, a component that falls within the scope of METI Ministerial ordinance No. 85 is properly used in accordance with its marked ratings, requirements of 1.5.4, 2.8.7 and 3.2.5 apply, and in addition, for connector of power cord set which is capable of insertion to one of appliance inlets specified in either IEC 60320-1 or JIS C 8283-1, the connector shall comply with the dimensions of the appropriate connector specified in IEC 60320-1 or JIS C 8283-1.</p> <p>Replace NOTE 1 with the following:</p> <p>NOTE 1 A JIS or an IEC component standard is considered relevant only if the component in question clearly falls within its scope.</p>	Replaced.	P

IEC60950_1F - ATTACHMENT			
Clause	Requirement + Test	Result - Remark	Verdict
1.5.2	<p>Replace first sentence in the first dashed paragraph with the following:</p> <ul style="list-style-type: none"> - a component that has been demonstrated to comply with a JIS component standard harmonized with the relevant IEC component standard, or where such JIS component standard is not available, a component that has been demonstrated to comply with the relevant IEC component standard shall be checked for correct application and use in accordance with its rating. <p>Replace existing NOTE to NOTE 1 without modification of the sentence in the second dashed paragraph.</p> <p>Replace “where no relevant IEC component standard exists” to “where neither the relevant IEC component standard nor JIS standard corresponding to the relevant IEC component standard exists” in the third dashed paragraph.</p> <p>Add NOTE 2 as follows: NOTE 2 If an appliance inlet with a rated current of 10A, which is of STANDARD SHEET C14 specified in JIS C 8283-1, is used for equipment with a rated voltage of 125V or less; and with a rated current of exceeding 10A, refer to 1.7.5A.</p>	Considered.	P
1.5.9.1	<p>General</p> <p>Replace the following at first dash of NOTE 2:</p> <p>JIS C5381-21 [Part 21 of Low pressure surge protection device : Performance requirement and test method of surge protection device (SPD) which connected with communication channel and signal]</p>	No gas discharge tube.	N/A
1.5.9.4	<p>Add the following at last paragraph:</p> <p>It is permitted to use a gas discharge tube (GDT) in series with a VDR that bridges BASIC INSULATION in accordance with the conditions in this subclause if the GDT complies with the requirements for FUNCTIONAL INSULATION.</p>		N/A

IEC60950_1F - ATTACHMENT			
Clause	Requirement + Test	Result - Remark	Verdict
1.7.1	<p>Replace the existing dashed items for manufacturer's name etc. and for model identification etc. with the following respectively:</p> <ul style="list-style-type: none"> - manufacturer's (or responsible business operator's) name or trade-mark or identification mark; - manufacturer's (or responsible business operator's) model identification or type reference; <p>In the last paragraph, replace "ISO 7000 or IEC 60417" with "JIS S 0101, ISO 7000 or IEC 60417".</p>	Added.	P
1.7.2.1	<p>Add the following: Instructions and the marking(s) on equipment, which related to safety, shall be made in Japanese.</p>		N/A
1.7.5	<p>Replace IEC 60083 with JIS C 8303 in the second paragraph.</p>	No such outlets.	N/A
1.7.5A	<p>Add the following new clause after 1.7.5</p> <p>1.7.5.A Power supply cord set</p> <p>If an appliance inlet with a rated current of 10 A, which is of STANDARD SHEET C14 specified in JIS C 8283-1, is used for equipment with a rated voltage of 125 V or less and with a rated current of exceeding 10 A, the operating instructions shall provide the following or equivalent instruction:</p> <p>"この機器に同こん(梱)した指定の電源コードセットだけを使用する。"</p> <p>For equipment with an appliance inlet, if a power supply cord set is not provided by packing together with the equipment, the operating instructions shall provide information on the applicable power supply cord set.</p> <p>NOTE For the combination of CLASS 01 EQUIPMENT equipped with an appliance inlet with earthing contact and a power supply cord set of two conductors (exclude earthing conductor), to pack the power supply cord set together with the equipment and to provide a sentence calling attention of the following purport in the operating instructions are recommended, because such power supply cord set is a special kind of cord set:</p> <ul style="list-style-type: none"> - this is usable only for this equipment; and - to use this for other equipment is not allowed. 	No appliance coupler.	N/A

IEC60950_1F - ATTACHMENT			
Clause	Requirement + Test	Result - Remark	Verdict
1.7.14A	<p>Add the following new clause after 1.7.14</p> <p>1.7.14A Marking for protective earthing connection for CLASS 0I EQUIPMENT</p> <p>CLASS 0I EQUIPMENT shall be provided with the following or equivalent instruction:</p> <ul style="list-style-type: none"> - on the mains-plug or the easily visible section of equipment, the following instruction: 必ず接地接続を行って下さい。 - in the easily visible section of equipment or in the operating instructions, the following instruction: 接地接続は必ず、電源プラグを電源につなぐ前に行って下さい。 また、接地接続を外す場合は、必ず電源プラグを電源から切り離してから行って下さい。 	Added. Class I equipment considered.	N/A
1.7.14B	<p>Add the following new clause after 1.7.14</p> <p>1.7.14B Protective earth wire used for CLASS 0I EQUIPMENT</p> <p>For CLASS 0I EQUIPMENT equipped with a separate protective earthing terminal as main protective earthing terminal, if a protective earth wire is not provided by packing together with the equipment, the operating instructions shall provide information on the applicable protective earth wire. (See 2.6.3.2.)</p>	Added. Class I equipment considered.	N/A
2.1.1.1	In b) of the fifth paragraph, replace "IEC 60083, IEC 60309, IEC 60320, IEC 60906-1 or IEC 60906-2" with "JIS C 8303, (the Ministerial Ordinance establishing Technical Requirements for Electrical Appliances and Materials, METI Ordinance No. 85, Clause 1 (METI Ordinance No. 34 of 2013), JIS C 8285, the IEC 60309 series of standards, the JIS C 8283 series of standards, the IEC 60320 series of standards".	Replaced.	P
2.6.3.2	<p>Add the following:</p> <p>If the conductor of protective earthing lead wire or the protective earth wire of CLASS 0I EQUIPMENT is of single-core, it shall be one of the following:</p> <ul style="list-style-type: none"> - annealed copper wire of 1,6 mm in diameter, or metallic wire having the same or more strength and diameter and being not easily corrosive; or - single-core cord or single-core cable (sheathed flexible cable), which have a cross-sectional area of at least 1,25 mm². 	Added. Class I equipment considered.	N/A
2.6.3.5	<p>Add the following:</p> <p>However, this requirement does not apply to the inside conductor of power supply cord (or power supply cord set), which has been molded together with a plug and a connector and has been sheathed.</p>	Added.	N/A

IEC60950_1F - ATTACHMENT			
Clause	Requirement + Test	Result - Remark	Verdict
2.6.4.2	Add the following: For CLASS 0I EQUIPMENT equipped with a separate protective earthing terminal, the protective earthing terminal may be used as the main protective earthing terminal.	Added. Class I equipment considered.	N/A
2.6.5.4	Replace 1st sentence with the following. "Protective earthing conductors" with "Protective earthing conductors of CLASS I EQUIPMENT".	Replaced.	P
2.6.5.6	Replace "protective earthing terminals" with "protective earthing and protective bonding terminals".	Replaced.	P
2.6.5.8A	Add the following new clause. after 2.6.5.8A 2.6.5.8A Earthing of CLASS 0I EQUIPMENT Plugs with a lead wire for earthing shall not be used for equipment having a rated voltage exceeding 150V. For plugs with a lead wire for earthing, the lead wire shall not be earthed by a clip. CLASS 0I EQUIPMENT shall be provided with an earthing terminal or lead wire for earthing in the external location where easily visible.	Added. Class I equipment considered.	N/A
2.9.3 Table 2H	Deleted the following mark of Figure 2H: B13 e) and S2 d)	Deleted	N/A
2.9.3 Figure 2H	Addition of marking for table 2H: B8, B9, B12, B13, S1	Added	N/A
2.10.3.1	In the third paragraph, replace IEC 60664-1 with JIS C 60664-1. Replace the 8th paragraph with the following: The above minimum CLEARANCES for connectors do not apply to: - connectors that comply with JIS C 8285, the IEC 60309 series of standards, the JIS C 8283 series of standards, the IEC 60320 series of standards or JIS C 8303; and - connectors that comply with the Ministerial Ordinance establishing Technical Requirements for Electrical Appliances and Materials MEIT Ordinance No. 85, Clause 1 (METI Ordinance No. 34 of 2013), and comply with the dimensions specified in the JIS C 8283 series of standards, JIS C 8303 or IEC 60309-2; see also 1.5.2.	Replaced.	P
2.10.3.2	In the bottom column of Table 2J, add the following: In Japan, the MAINS TRANSIENT VOLTAGE value against the nominal AC MAINS SUPPLY voltage of 100 V is decided by applying the columns for the AC MAINS SUPPLY voltage of 150 V.	Added.	P

IEC60950_1F - ATTACHMENT			
Clause	Requirement + Test	Result - Remark	Verdict
2.10.3.3	In Table 2L, add the following into the column specifying the additional CLEARANCES and at the end: For intermediate voltage values between the PEAK WORKING VOLTAGE values given in this table, linear interpolation is permitted between the nearest two points, the calculated additional minimum CLEARANCE being rounded up to the next higher 0,1 mm increment.	Added.	P
2.10.4.3	Replace the 6th paragraph with the following: The above minimum CLEEPAGE DISTANCES for connectors do not apply to: - connectors that comply with JIS C 8285, the IEC 60309 series of standards, the JIS C 8283 series of standards, the IEC 60320 series of standards or JIS C 8303; and - connectors that comply with the Ministerial Ordinance establishing Technical Requirements for Electrical Appliances and Materials MEIT Ordinance No. 85, Clause 1 (METI Ordinance No. 34 of 2013), and comply with the dimensions specified in the JIS C 8283 series of standards, JIS C8303 or IEC 60309-2; see also 1.5.2.	Replaced.	P
2.10.9	Replace clause which as test method of T^1 from 1.4.5 to 1.4.12.	Replaced.	N/A
3.2.1.1	Add the following: When equipment with an appliance inlet connects to AC mains supply, see clause 1.7.5A for the relevant mark of power supply cord set.	Added.	N/A
3.2.3	Add the following after Table 3A: Table 3A applies when cables complying JIS C 3662 or JIS C 3663 are used. In case of other cables, cable entries shall be so designed that a conduit suitable for the cable used can be fitted.	Added.	N/A
3.2.4	Add the following: The equipment shall have a structure of which the soldered sections of the terminals of appliance inlet are not subjected to mechanical stress during the insertion or removal of the connector, except the case fixing the appliance inlet itself mechanically but not only by soldering.	Body of appliance inlet secured to metal chassis by screws and lock washer, and wire soldered to inlet pins.	P
3.2.5.1	At the end of the first dashed item, replace “; and” with “, or be a sheathed cord complying with Appendix 1 specified in the Interpretation for the Ministerial Ordinance establishing Technical Requirements for Electrical Appliances and Materials MEIT Ordinance No. 85, Clause 1 (METI Ordinance No. 34 of 2013); and”.	Added.	N/A

IEC60950_1F - ATTACHMENT			
Clause	Requirement + Test	Result - Remark	Verdict
	In the second dashed item, replace “insulated:” with “insulated, be a cord of the following or be a sheathed cord complying with Appendix 1 specified in the Interpretation for the Ministerial Ordinance establishing Technical Requirements for Electrical Appliances and Materials MEIT Ordinance No. 85, Clause 1 (METI Ordinance No. 34 of 2013), :”	Replaced.	N/A
	In the third dashed item, add the following: However, the coating of the protective earth conductor inside covered with sheath (cord set) power cord integrally formed with the connector and the plug need not be a combination of green and yellow. In addition, the power cord of CLASS OI EQUIPMENT having a protective earth conductor separately, it is not necessary to provide a protective earth conductor.	Added.	N/A
	Replace the existing fourth dashed item with the following: - if those complying with JIS C 3662-5 or JIS C 3663-4, have conductors with cross-sectional areas not less than those specified in Table 3B, and if others, comply with the relevant wiring rules. In Table 3B, replace “IEC 60320” with “the JIS C8283 series of standards or the IEC 60320 series of standards”.	Replaced.	N/A
3.3.4	Add the following note to Table 3D: For cables other than those complying with JIS C 3662 or JIS C 3663, terminals shall be suitable for the size of the intended cables.	Added.	N/A
3.3.7	Add the following after the first sentence: This requirement is not applicable to the external earthing terminal of CLASS OI EQUIPMENT.	Added.	N/A
4.3.4	Add the following after the first sentence: This requirement also applies to those connections in CLASS OI EQUIPMENT, where CLEARANCE or CREEPAGE DISTANCES of BASIC INSULATION would be reduced to less than the values specified in 2.10.	Added. Class I equipment considered.	N/A
4.3.5	In the paragraph, replace “IEC 60083 or IEC 60320” with “the JIS C 8283 series of standards, JIS C 8303 or JIS C 8358”.	Replaced.	N/A

IEC60950_1F - ATTACHMENT																																							
Clause	Requirement + Test	Result - Remark	Verdict																																				
4.5.3	In the item b in Table 4B, add the following: NOTE If no data of material is available, Appendix 4, 1(1), ^p ,3 specified in the Interpretation for “the Ministerial Ordinance establishing Technical Requirements for Electrical Appliances and Materials MEIT Ordinance No. 85, Clause 1 (METI Ordinance No. 34 of 2013)” is applicable. In the item c in Table 4B, replace IEC 60085 with JIS C 4003.	Replaced.	P																																				
5.1.3	Add a note after the first paragraph as follows: NOTE In Japan, three-phase power distribution systems of delta connection are typical, therefore, in such case, test is conducted using the test circuit from IEC 60990, figure 13.	Added.	P																																				
5.1.6	Replace Table 5A as follows	Replaced.	P																																				
	<table border="1"> <thead> <tr> <th>Type of equipment</th> <th>Terminal A of measuring instrument connected to:</th> <th>Maximum TOUCH CURRENT mA r.m.s.^a</th> <th>Maximum PROTECTIVE CONDUCTOR CURRENT</th> </tr> </thead> <tbody> <tr> <td>All equipment</td> <td>Accessible parts and circuits not connected to protective earth^b</td> <td>0,25</td> <td>–</td> </tr> <tr> <td rowspan="2">HAND-HELD</td> <td>Class I equipment main protective earthing terminal</td> <td>0,75</td> <td>–</td> </tr> <tr> <td>Class 0I equipment main protective earthing terminal</td> <td>0,5</td> <td>–</td> </tr> <tr> <td rowspan="2">MOVABLE (other than HAND-HELD, but including TRANSPORTABLE EQUIPMENT)</td> <td>Class I equipment main protective earthing terminal</td> <td>3,5</td> <td>–</td> </tr> <tr> <td>Class 0I equipment main protective earthing terminal</td> <td>1,0</td> <td>–</td> </tr> <tr> <td rowspan="2">STATIONARY, PLUGGABLE TYPE A</td> <td>Class I equipment main protective earthing terminal</td> <td>3,5</td> <td>–</td> </tr> <tr> <td>Class 0I equipment main protective earthing terminal</td> <td>1,0</td> <td>–</td> </tr> <tr> <td rowspan="2">All other STATIONARY EQUIPMENT – not subject to the conditions of 5.1.7 – subject to the conditions of 5.1.7</td> <td>Class I equipment main protective earthing terminal</td> <td>3,5 –</td> <td>– 5 % of input current</td> </tr> <tr> <td>Class 0I equipment main protective earthing terminal</td> <td>1,0 –</td> <td>– –</td> </tr> </tbody> </table> <p>^a If peak values of TOUCH CURRENT are measured, the maximum values are obtained by multiplying the r.m.s. values in the table by 1,414.</p> <p>^b Some unearthed accessible parts are covered in 1.5.6 and 1.5.7 and the requirements of 2.4 apply. These may be different from those in 5.1.6.</p>			Type of equipment	Terminal A of measuring instrument connected to:	Maximum TOUCH CURRENT mA r.m.s. ^a	Maximum PROTECTIVE CONDUCTOR CURRENT	All equipment	Accessible parts and circuits not connected to protective earth ^b	0,25	–	HAND-HELD	Class I equipment main protective earthing terminal	0,75	–	Class 0I equipment main protective earthing terminal	0,5	–	MOVABLE (other than HAND-HELD, but including TRANSPORTABLE EQUIPMENT)	Class I equipment main protective earthing terminal	3,5	–	Class 0I equipment main protective earthing terminal	1,0	–	STATIONARY, PLUGGABLE TYPE A	Class I equipment main protective earthing terminal	3,5	–	Class 0I equipment main protective earthing terminal	1,0	–	All other STATIONARY EQUIPMENT – not subject to the conditions of 5.1.7 – subject to the conditions of 5.1.7	Class I equipment main protective earthing terminal	3,5 –	– 5 % of input current	Class 0I equipment main protective earthing terminal	1,0 –	– –
Type of equipment	Terminal A of measuring instrument connected to:	Maximum TOUCH CURRENT mA r.m.s. ^a	Maximum PROTECTIVE CONDUCTOR CURRENT																																				
All equipment	Accessible parts and circuits not connected to protective earth ^b	0,25	–																																				
HAND-HELD	Class I equipment main protective earthing terminal	0,75	–																																				
	Class 0I equipment main protective earthing terminal	0,5	–																																				
MOVABLE (other than HAND-HELD, but including TRANSPORTABLE EQUIPMENT)	Class I equipment main protective earthing terminal	3,5	–																																				
	Class 0I equipment main protective earthing terminal	1,0	–																																				
STATIONARY, PLUGGABLE TYPE A	Class I equipment main protective earthing terminal	3,5	–																																				
	Class 0I equipment main protective earthing terminal	1,0	–																																				
All other STATIONARY EQUIPMENT – not subject to the conditions of 5.1.7 – subject to the conditions of 5.1.7	Class I equipment main protective earthing terminal	3,5 –	– 5 % of input current																																				
	Class 0I equipment main protective earthing terminal	1,0 –	– –																																				
6	Add following in the end of NOTE 1: For suitable additional measures, see Annex JB.	No TNV.	N/A																																				
6.1.2.1	Add the following: NOTE 3 For example, the highest nominal voltage is 230 V in Europe and 120 V in North America.	No TNV.	N/A																																				

IEC60950_1F - ATTACHMENT			
Clause	Requirement + Test	Result - Remark	Verdict
Annex G.6	<p>Replace the existing 8th paragraph with the following: The above minimum CLEARANCES for connectors do not apply to:</p> <ul style="list-style-type: none"> - connectors that comply with JIS C 8285, the IEC 60309 series of standards, the JIS C 8283 series of standards, the IEC 60320 series of standards or JIS C 8303; and - connectors that with the Ministerial Ordinance establishing Technical Requirements for Electrical Appliances and Materials (MEIT Ordinance No. 34 of 2013) and comply with the dimensions specified in the JIS C 8283 series of standards, JIS C 8303 or IEC 60309-2; <p>see also 1.5.2.</p>	<p>Replaced. The alternative method was not considered.</p>	N/A
Annex M	<p>In M.1, replace the existing paragraph with the following: One of the two methods specified in this annex shall be applied. NOTE Method A specified in the annex is typical of analogue telephone network in Europe and Method B of those in North America.</p>	No telephone ringing signals.	N/A
Annex P	<p>Replace the existing Annex P with the following:</p>	Replaced.	P
	<p style="text-align: center;">Annex P (normative)</p> <p style="text-align: center;">Normative references</p> <p>The following reference documents are indispensable for the application of this standard. If the date of the reference document is given, only that edition applies, and any newer edition and subsequent amendments do not apply. If the date of the reference document is not given, the latest edition including the amendments applies.</p> <p>Further information on the reference documents, including how to obtain copies, can be found on the following internet sites:</p> <p style="text-align: center;"> http://www.jisc.go.jp/ http://www.iec.ch http://www.iso.org http://www.itu.int </p> <p>JIS B 0205-2, ISO general purpose metric screw threads - Part2: General plan NOTE Corresponding IS: ISO 261, ISO general purpose metric screw threads – General plan (IDT)</p> <p>JIS B 0205-3, ISO general purpose metric screw threads - Part3 : Selected sizes for screws, bolts and nuts NOTE Corresponding IS: ISO 262, ISO general purpose metric screw threads - Selected sizes for screws, bolts and nuts (IDT)</p> <p>JIS C 0448, Coding of indicating devices and actuators by colours and supplementary means NOTE Corresponding IS: IEC 60073, Basic and safety principles for man-machine interface, marking and identification - Coding principles for indicator devices and actuators (IDT)</p> <p>JIS C 2134, Method for the determination of the proof and the comparative tracking indices of solid insulating materials NOTE Corresponding IS: IEC 60112, Method for the determination of the proof and the comparative tracking indices of insulating materials (IDT)</p> <p>JIS C 3215 (all parts), Specifications for particular types of winding wires NOTE Corresponding IS: IEC 60317 (all parts), Specifications for particular types of winding wires (IDT)</p> <p>JIS C 3661-1:1998, Electrical test methods for electric cables - Part 1: Electrical tests for cables, cords and wires for voltages up to and including 450/750V NOTE Corresponding IS: IEC 60885-1:1987, Electrical test methods for electric cables. Part 1: Electrical tests for cables, cords and wires for voltages up to and including 450/750 V (IDT)</p> <p>JIS C 3662 (all parts), Polyvinyl chloride insulated cables of rated voltages up to and including 450/750V - Part 1 : General requirements</p>		

IEC60950_1F - ATTACHMENT			
Clause	Requirement + Test	Result - Remark	Verdict
	<p>NOTE Corresponding IS: IEC 60227 (all parts), Polyvinyl chloride insulated cables of rated voltages up to and including 450/750 V (MOD)</p> <p>JIS C 3663 (all parts), Rubber insulated cables - Rated voltages up to and including 450/750 V</p> <p>NOTE Corresponding IS: IEC 60245 (all parts), Rubber insulated cables - Rated voltages up to and including 450/750 V (MOD)</p> <p>JIS C 4003, Electrical insulation-Thermal evaluation and designation</p> <p>NOTE Corresponding IS: IEC 60085:2004, Electrical insulation - Thermal classification (MOD)</p> <p>JIS C 4526-1:2005, Switches for appliances - Part 1: General requirements</p> <p>NOTE Corresponding IS: IEC 61058-1:2000, Switches for appliances - Part 1: General requirements (MOD)</p> <p>JIS C 5101-14:2009, Fixed capacitors for use in electronic equipment - Part 14: Sectional specification: Fixed capacitors for electromagnetic interference suppression and connection to the supply mains</p> <p>NOTE Corresponding IS: IEC 60384-14:2005, Fixed capacitors for use in electronic equipment - Part 14: Sectional specification: Fixed capacitors for electromagnetic interference suppression and connection to the supply mains (IDT)</p> <p>JIS C 6065:2007 and Amendment 1:2009, Audio, video and similar electronic apparatus - Safety requirements</p> <p>NOTE Corresponding IS: IEC 60065:2001, Audio, video and similar electronic apparatus - Safety requirements and Amendment 1:2005 (MOD)</p> <p>JIS C 6802, Safety of laser products</p> <p>NOTE Corresponding IS: IEC 60825-1, Safety of laser products-Part 1: Equipment classification and requirements (IDT)</p> <p>JIS C 6803, Safety of laser products-Safety of optical fiber communication systems</p> <p>NOTE Corresponding IS: IEC 60825-2, Safety of laser products-Part 2: Safety of optical fiber communication systems (OFCS) (IDT)</p> <p>JIS C 6804, Safety of laser products-Safety of free space optical communication systems used for transmission of information</p> <p>NOTE Corresponding IS: IEC 60825-12, Safety of laser products - Part 12: Safety of free space optical communication systems used for transmission of information (IDT)</p> <p>JIS C 8201-1:2007, Low-voltage switchgear and controlgear-Part 1: General rules</p> <p>NOTE Corresponding IS: IEC 60947-1:2004, Low-voltage switchgear and controlgear - Part 1: General rules (MOD)</p> <p>JIS C 8283 (all parts), Appliance couplers for household and similar general purposes</p> <p>NOTE Corresponding IS: IEC 60320 (all parts), Appliances couplers for household and similar general purposes (MOD)</p> <p>JIS C 8285, Plugs, socket-outlets and couplers for industrial purposes</p> <p>NOTE Corresponding IS: IEC 60309-1, Plugs, socket-outlets and couplers for industrial purposes - Part 1: General requirements (MOD)</p> <p>JIS C 8303, Plugs and receptacles for domestic and similar general use</p> <p>JIS C 8358:1994, Appliance couplers for domestic and similar use</p> <p>JIS C 9730-1:2010, Automatic electrical controls for household and similar use - Part 1:General requirements</p> <p>NOTE Corresponding IS: IEC 60730-1:1999, Automatic electrical controls for household and similar use - Part 1: General requirements and Amendment 1:2003 (MOD)</p> <p>JIS C 60068-2-78, Environmental testing - Test Cab:Damp heat,steady state</p> <p>NOTE Corresponding IS: IEC 60068-2-78, Environmental testing - Part 2-78: Tests - Test Cab: Damp heat, steady state (IDT)</p> <p>JIS C 60364-1:2006, Low-voltage electrical installations - Part 1: Fundamental principles, assessment of general characteristics, definitions</p> <p>NOTE Corresponding IS: IEC 60364-1:2001, Electrical installations of buildings - Part 1: Fundamental principles, assessment of general characteristics, definitions (IDT)</p> <p>JIS C 60664-1:2009, Insulation coordination for equipment within low-voltage systems - Part 1:Principles,requirements and tests</p> <p>NOTE Corresponding IS: IEC 60664-1:1992, Insulation coordination for equipment within low-voltage systems - Part 1: Principles, requirements and tests, Amendment 1:2000 and Amendment 2:2002 (IDT)</p> <p>JIS C 60695-2-11, Fire hazard testing - Glow-wire flammability test method for end-products</p> <p>NOTE Corresponding IS: IEC 60695-2-11, Fire hazard testing - Part 2-11: Glowing/hot-wire based test methods - Glow-wire flammability test method for end-products (IDT)</p> <p>JIS C 60695-2-20, Fire hazard testing—Part 2 : Glowing /Hot wire based test methods—Section 20 : Hot-wire coil ignitability test on materials</p> <p>NOTE Corresponding IS: IEC/TS 60695-2-20, Fire hazard testing - Part 2-20: Glowing/hot wire based test methods - Hot-wire coil ignitability - Apparatus test method and guidance (IDT)</p> <p>JIS C 60695-10-2, Fire hazard testing-Part 10-2: Abnormal heat-Ball pressure test</p> <p>NOTE Corresponding IS: IEC 60695-10-2, Fire hazard testing - Part 10-2: Abnormal heat - Ball pressure test (IDT)</p> <p>JIS C 60695-11-5:2007, Fire hazard testing-Part 11-5:Test flames-Needle-flame test method - Apparatus, confirmatory test arrangement and guidance</p> <p>NOTE Corresponding IS: IEC 60695-11-5:2004, Fire hazard testing - Part 11-5: Test flames - Needle-flame test method - Apparatus, confirmatory test arrangement and guidance (IDT)</p>		

IEC60950_1F - ATTACHMENT			
Clause	Requirement + Test	Result - Remark	Verdict
	<p>JIS C 60695-11-10, Fire hazard testing-Part 11-10:Test flames - 50 W horizontal and vertical flame test methods NOTE Corresponding IS: IEC 60695-11-10, Fire hazard testing - Part 11-10: Test flames - 50 W horizontal and vertical flame test methods (IDT)</p> <p>JIS C 60695-11-20, Fire hazard testing-Part 11-20: Test flames - 500 W flame test methods NOTE Corresponding IS: IEC 60695-11-20, Fire hazard testing - Part 11-20: Test flames - 500 W flame test methods (IDT)</p> <p>JIS C 7550:2011, Safety for lighting of lamp and lamp system on biology</p> <p>JIS C 60695-10-3:2005, Fire resistance test – Electrical . Electronic – Part 10-3 : Thermal caused abnormal – Deformation test of molded stress after released NOTE Corresponding IS: IEC 60695-10-3:2002, Fire hazard testing – Part 10-3 : Abnormal heat – Mould stress relief distortion test (IDT)</p> <p>JIS K 7110, Plastics - Determinaion of Izod impact strength NOTE Corresponding IS: ISO 180, Plastics - Determination of Izod impact strength (MOD)</p> <p>JIS K 7111 (all parts), Plastics-Determination of Charpy impact properties - Part 1: Non-instrumented impact test NOTE Corresponding IS: ISO 179 (all parts), Plastics - Determination of Charpy impact properties (MOD)</p> <p>JIS K 7127, Plastics - Determination of tensile properties—Part 3 : Test conditions for films and sheets NOTE Corresponding IS: ISO 527-3, Plastics - Determination of tensile properties - Part 3: Test conditions for films and sheets (IDT)</p> <p>JIS K 7160, Plastics—Determination of tensile-impact strength NOTE Corresponding IS: ISO 8256, Plastics - Determination of tensile-impact strength (IDT)</p> <p>JIS K 7161, Plastics—Determination of tensile properties—Part 1 : General principles NOTE Corresponding IS: ISO 527-1, Plastics - Determination of tensile properties - Part 1: General principles (IDT)</p> <p>JIS K 7162, Plastics - Determination of tensile properties - Part 2 : Test conditions for moulding and extrusion plastics NOTE Corresponding IS: ISO 527-2, Plastics - Determination of tensile properties - Part 2: Test conditions for moulding and extrusion plastics (IDT)</p> <p>JIS K 7164, Plastics - Determination of tensile properties - Test conditions for isotropic and orthotropic fibre-reinforced plastic composites NOTE Corresponding IS: ISO 527-4, Plastics - Determination of tensile properties - Part 4: Test conditions for isotropic and orthotropic fibre-reinforced plastic composites (MOD)</p> <p>JIS K 7165, Plastics-Determination of tensile properties-Part 5: Test conditions for unidirectional fibre-reinforced plastic composites NOTE Corresponding IS: ISO 527-5, Plastics - Determination of tensile properties - Part 5: Test conditions for unidirectional fibre-reinforced plastic composites (MOD)</p> <p>JIS K 7171, Plastics - Determination of flexural properties NOTE Corresponding IS: ISO 178, Plastics - Determination of flexural properties (IDT)</p> <p>JIS K 7241, Cellular plastics-Determination of horizontal burning characteristics of small specimens subjected to a small flame NOTE Corresponding IS: ISO 9772, Cellular plastics - Determination of horizontal burning characteristics of small specimens subjected to a small flame (IDT)</p> <p>JIS K 7341, Plastics-Determination of burning behaviour of thin flexible vertical specimens in contact with a small-flame ignition source NOTE Corresponding IS: ISO 9773, Plastics - Determination of burning behaviour of thin flexible vertical specimens in contact with a small-flame ignition source (IDT)</p> <p>JIS K 7350-1, Plastics - Methods of exposure to laboratory light sources - Part 1: General guidance NOTE Corresponding IS: ISO 4892-1, Plastics - Methods of exposure to laboratory light sources - Part 1: General guidance (IDT)</p> <p>JIS K 7350-2, Plastics - Methods of exposure to laboratory light sources - Part 2 : Xenon-arc lamps NOTE Corresponding IS: ISO 4892-2, Plastics - Methods of exposure to laboratory light sources - Part 2: Xenon-arc lamps (MOD)</p> <p>JIS K 7350-4, Plastics - Methods of exposure to laboratory light sources - Part 4: Open-flame carbon-arc lamps NOTE Corresponding IS: ISO 4892-4, Plastics - Methods of exposure to laboratory light sources - Part 4: Open-flame carbon-arc lamps (MOD)</p> <p>JIS S 0101:2000, Graphical warning symbols for consumers</p> <p>TS C 60695-11-3, Fire hazard testing - Part 11-3: Test flames - 500 W flames - Apparatus and confirmational test methods NOTE Corresponding IS: IEC 60695-11-3, Fire hazard testing - Part 11-3: Test flames - 500 W flames - Apparatus and confirmational test methods (IDT)</p> <p>TS C 60695-11-4, Fire hazard testing - Part 11-4: Test flames - 50 W flames - Apparatus and confirmational test methods NOTE Corresponding IS: IEC 60695-11-4, Fire hazard testing - Part 11-4: Test flames - 50 W flames - Apparatus and confirmational test methods (IDT)</p> <p>IEC 60216-4-1, Electrical insulating materials - Thermal endurance properties - Part 4-1: Ageing ovens - Single-chamber ovens</p>		

IEC60950_1F - ATTACHMENT			
Clause	Requirement + Test	Result - Remark	Verdict
	<p>IEC 60309 (all parts), Plugs, socket-outlets and couplers for industrial purposes</p> <p>IEC 60317 (all parts), Specifications for particular types of winding wires</p> <p>IEC 60317-43, Specifications for particular types of winding wires - Part 43: Aromatic polyimide tape wrapped round copper wire, class 240</p> <p>IEC 60320 (all parts), Appliance couplers for household and similar general purposes</p> <p>IEC 60417-DB:2002, Graphical symbols for use on equipment (For DB, see the online database of the IEC.)</p> <p>IEC 60747-5-5, Semiconductor devices - Discrete devices - Part 5-5: Optoelectronic devices – Photocouplers</p> <p>IEC/TR 60825-9, Safety of laser products - Part 9: Compilation of maximum permissible exposure to incoherent optical radiation</p> <p>IEC 60851-3:1996, Winding wires - Test methods - Part 3: Mechanical properties and Amendment 1:1997</p> <p>IEC 60851-5:1996, Winding wires - Test methods - Part 5: Electrical properties, Amendment 1:1997 and Amendment 2:2004</p> <p>IEC 60851-6:1996, Methods of test for winding wires - Part 6: Thermal properties</p> <p>IEC 60947-1:2004, Low-voltage switchgear and controlgear - Part 1: General rules</p> <p>IEC 60990:1999, Methods of measurement of touch current and protective conductor current</p> <p>IEC 61051-2, Varistors for use in electronic equipment - Part 2: Sectional specification for surge suppression varistors</p> <p>ISO 180, Plastics - Determination of Izod impact strength</p> <p>ISO 3864-2:2004, Graphical symbols – Safety colours and safety signs – Part 2: principles for product safety labels.</p> <p>ISO 4892-1:2004, Plastics - Methods of exposure to laboratory light sources - Part 1: General guidance</p> <p>ISO 7000-DB:2004, Graphical symbols for use on equipment - Index and synopsis (For DB, see the online database of the IEC.)</p> <p>ISO 8256, Plastics - Determination of tensile-impact strength</p> <p>ITU-T Recommendation K.44, Resistibility tests for telecommunication equipment exposed to overvoltages and overcurrents - Basic Recommendation</p>		
Annex U.2.4	<p>Replace the existing NOTE as NOTE1, add NOTE 2 as follows:</p> <p>NOTE 2 by taking into account environmental impact, “(for example, 1.1.1-trichloroethane)” described in the corresponding IEC standard was deleted.</p>		N/A
Annex V.1	<p>Replace “In 3.1.2 of IEC 60364-1” with “312 of JIS C 60364-1”.</p>		N/A
Annex W.1	<p>Replace second and third sentence in the first paragraph with the following:</p> <p>This distinction between earthed and unearthed (floating) circuit is not the same as between CLASS I EQUIPMENT, CLASS 0I EQUIPMENT and CLASS II EQUIPMENT. Floating circuits can exist in CLASS I EQUIPMENT or CLASS 0I EQUIPMENT and earthed circuits in CLASS II EQUIPMENT.</p>	Added.	P
Annex AA	<p>Replace figure AA.3 which correct the position of insulating metal sheet.</p>	Replaced.	N/A
Annex BB	<p>(Reference) [Change point which from IEC 60950-1 : 2001 (v1) to IEC 60950-1 : 2005 (v2)]</p> <p>(Deleted text body)</p>		—
Annex CC	<p>Evaluation of integrated circuit (IC) current limiters</p>	No circuit (IC) current limiters	N/A
CC.2	<p>Test program 1</p>		N/A

IEC60950_1F - ATTACHMENT			
Clause	Requirement + Test	Result - Remark	Verdict
	10 000 cycles of turning enable on and off with an iron-core inductor having (0.35± 0.1) mH inductance at 1 kHz and less than 1 Ω DC resistance value connected in the output circuit;		N/A
	10 000 cycles of turning enable on and off with the input connected to a capacitor rated 425 μF ± 10 μF and shorting the output;		N/A
	10 000 cycles of turning the input pin on and off with an iron-core inductor having (0.35 ± 0.1) mH inductance at 1 kHz and less than 1 Ω DC resistance value connected to the input supply and return while keeping enable active and shorting the output;		N/A
CC.3	Test program 2		N/A
	Note: It's advisable to use that in conformity with IEC 60127-2 for quick-fusing type fuse.		N/A
Annex EE	Household and home/office document/media shredders		N/A
	Note: Delete requirements of this Annex which corresponding IS and replace this Annex by Annex JA.		N/A
	Foreword of Annex JA (Requirements for shredder) was replaced by following: It shall conformity with requirements of this Annex for that add to body with Household and home/office document /media shredders.		N/A
Annex JA	Add a new annex JA with the following contents. Annex JA (normative) Requirements for document shredding machines (see 1.7, 2.8.3, 3.4 and 4.4) Introduction This annex specifies the safety requirements for document shredding machines, except those of STATIONARY EQUIPMENT used by connecting directly to 3-phase AC MAINS SUPPLY of a voltage not the than 200V. Document shredding machines shall comply with the requirements of this annex in addition to other requirements specified in this standard, except those of STATIONARY EQUIPMENT used by connecting directly to three-phase AC MAINS SUPPLY of a voltage not less than 200V.	Not document shredding machine.	N/A

IEC60950_1F - ATTACHMENT			
Clause	Requirement + Test	Result - Remark	Verdict
JA.1	<p>Markings and instructions</p> <p>In the easily visible part near to the slot for documents, by a method of clearly legible and permanent and by using easily understandable terms, document shredding machines shall have markings of the symbol  specified in 6.2.1 (general cautions) of JIS S 0101:2000, Graphical warning symbols for consumers, and also the following precautions for use:</p> <ul style="list-style-type: none"> - that use by an infants/children may cause a hazard of injury etc.; - that a hand can be drawn into the mechanical section for shredding when touching the document-slot; - that clothing can be drawn into the mechanical section for shredding when touching the document-slot; - that hairs can be drawn into the mechanical section for shredding when touching the document-slot; - in case of equipment incorporating a commutator motor, that equipment may catch fire or explode by spraying of flammable gas. 	Not document shredding machine.	N/A
JA.2	<p>Inadvertent reactivation</p> <p>Any safety interlock that can be operated by means of the test finger, Figure JA.1, is considered to be likely to cause inadvertent reactivation of the hazard.</p> <p>Compliance is checked by inspection and, where necessary, by a test with the test finger, Figure JA.1</p>	Not document shredding machine.	N/A
JA.3	<p>Disconnect switch</p> <p>Document shredding machines shall incorporate an isolating switch complying with sub-clause 3.4.2 as the device disconnecting the power of hazardous moving parts. For this switch, two-position (single-use) switch or multi-position (multifunction) switch (e.g., slide switch) may be used.</p> <p>If two-position switch, the positions for "ON" and "OFF" shall be indicated in accordance with sub-clause 1.7.8. If multi-position switch, the position for "OFF" shall be indicated in accordance with sub-clause 1.7.8 and other positions shall be indicated with proper terms or symbols.</p> <p>Compliance is checked by inspection.</p>	Not document shredding machine.	N/A

IEC60950_1F - ATTACHMENT			
Clause	Requirement + Test	Result - Remark	Verdict
JA.4	<p>Protection in operator access area</p> <p>Any warning shall not be used instead of the structure for preventing access to hazardous moving parts.</p> <p>Document shredding machines shall comply with the following requirements.</p> <p>Insert the test finger, Figure JA.1, into all openings in MECHANICAL ENCLOSURES without applying appreciable force. It shall not be possible to touch hazardous moving parts with the test finger. This consideration applies to all sides of MECHANICAL ENCLOSURES when the equipment is mounted as intended. Before testing with the test finger, remove the parts detachable without a tool.</p> <p>Insert the wedge-probe, Figure JA.2, into the document-slot. And, against all directions of openings, if straight-cutting type, a force of 45 N shall apply to the probe, and 90 N if cross-cutting type. In this case, the weight of the probe is to be factored into the overall applied force. Before testing with the wedge-probe, remove the parts detachable without a tool. It shall not be possible to touch any hazardous moving parts, including the shredding roller or the mechanical section for shedding, with the probe.</p>	See above.	N/A

IEC60950_1F - ATTACHMENT

Clause	Requirement + Test	Result - Remark	Verdict
--------	--------------------	-----------------	---------

Dimensions in millimeters

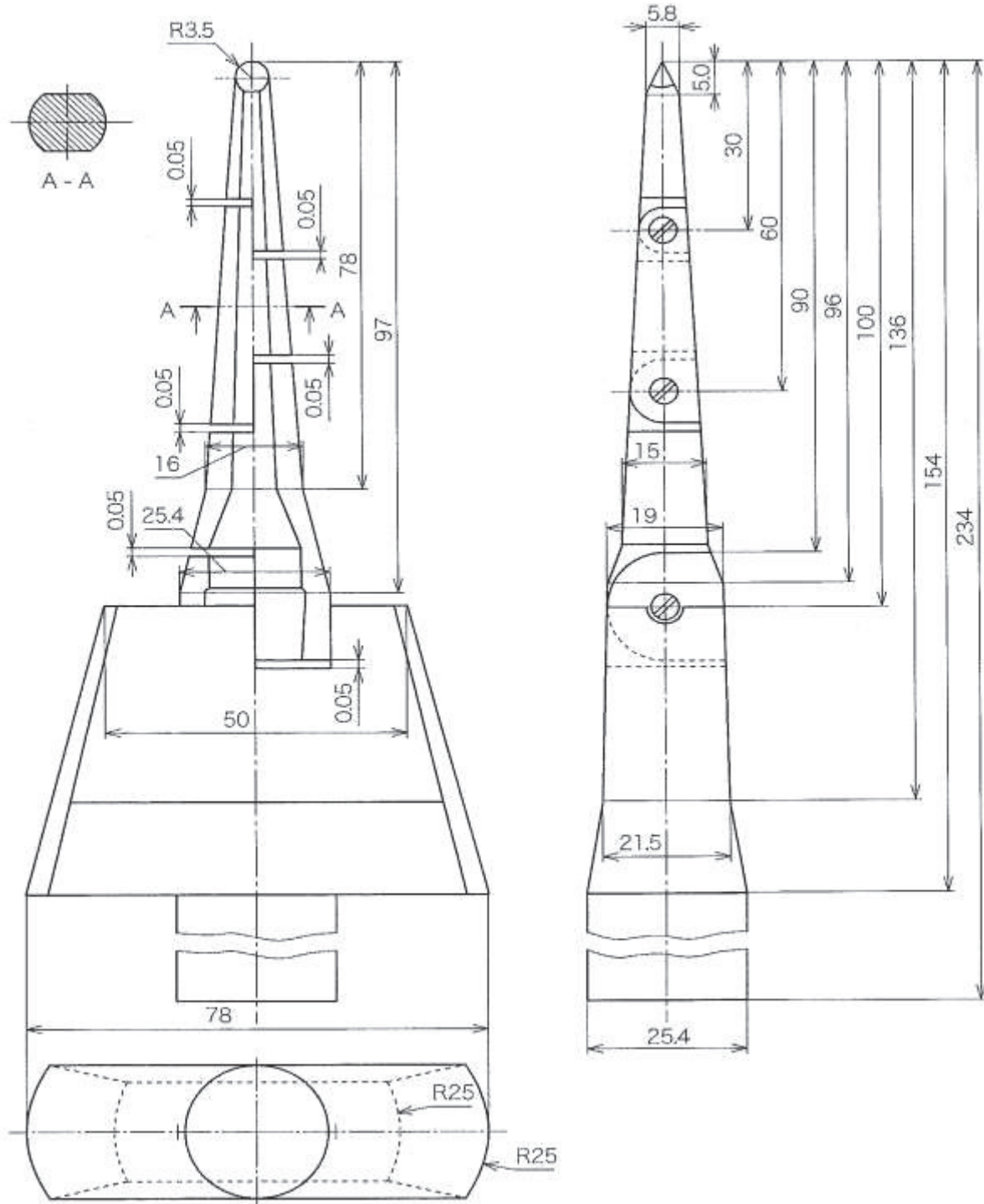
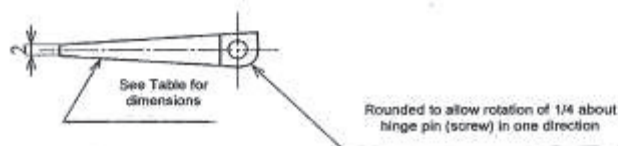
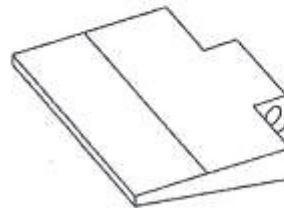
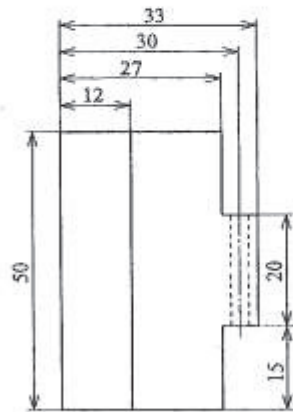
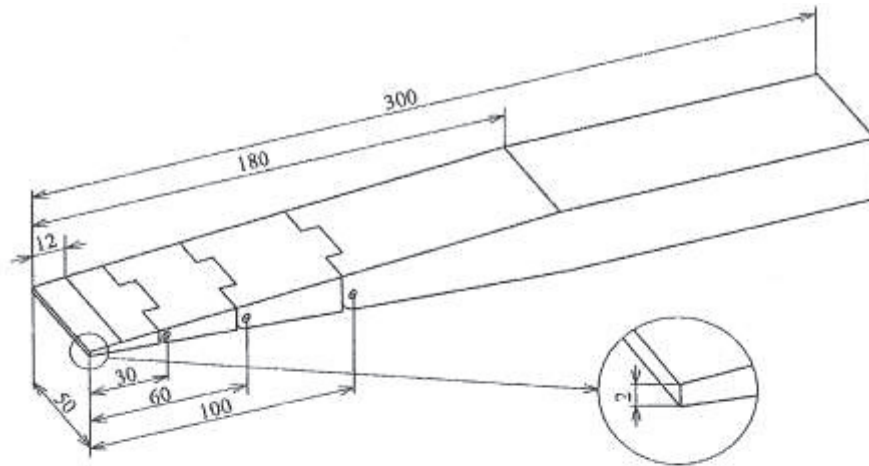

Figure JA.1 Test finger

IEC60950_1F - ATTACHMENT

Clause	Requirement + Test	Result - Remark	Verdict
--------	--------------------	-----------------	---------



Details of the tip of wedge

Dimensions in millimeters

Distance from the tip	Thickness of probe
0	2
12	4
180	24

The thickness of the probe varies linearly, except changing the slope at the respective points shown in the table. The allowable dimensional tolerance of the probe shall be +/- 0,127 mm.

Figure JA.2 Wedge-probe.

IEC60950_1F - ATTACHMENT			
Clause	Requirement + Test	Result - Remark	Verdict
Annex JB	<p>Add Annex JB as follows:</p> <p style="text-align: center;">Annex JB (informative)</p> <p>Current conditions Installation environment on overvoltages and overcurrents, and the measures (see NOTE 1 in Clause 6)</p> <p>Introduction This standard is based on “ITU-T Recommendation K.11:1993” to stipulate requirement for equipment on a premise to install in the environment where appropriate measures were taken for so that overvoltage more than peak 1.5kV does not hang to the apparatus. But in Japan due to environment is difficult to integrate with “ITU-T Recommendation K.11:1993”, in here explain for desirable environment and show actions to be taken how to make a desirable setting environment.</p>	Added.	N/A

IEC60950_1F - ATTACHMENT			
Clause	Requirement + Test	Result - Remark	Verdict
JB.1	<p>A desirable setting environment</p> <p>When lead electric wires in building for any kind service of metal wire, for overvoltage restraint and overcurrent restraint, it is desirable that be close to each other including grounding conductor. It is important to make it close each other especially the lead in point of power line, communication line and grounding conductor. In that case, attention is necessary for electromagnetic induction where occurred between a communication line and the power line which are not covered. It is desirable that set up main grounding terminal which close to lead in point of power line and communication line in building as much as possible. Due to minimize the surge current in building for all shielding conductor of cable which lead in building, it shall connected directly with main grounding terminal in lead in point via surge protection device (SPD) e.g. arrester and so on. It shall be considered corrosion measures in joint if necessary.</p> <p>It is desirable that SPD which set on communication line is close to lead in point toward the building as much as possible. Furthermore set the SPD near the main power line, and it may make the distance from SPD to a grounding conductor as short as possible. It is effective if use a short grounding conductor with low impedance for that decrease surge voltage between electric power system protection conductor and the communication line.</p>		N/A
	<p>Desirable setting environment for TT electric power system is as figure JB.1. Established SPD as that excessive potential difference does not occur between communication side and the electricity side, and recommend that ground wire of both are connected with a short conductor. Concerning the detail for recommend setting environment, see ITU-T Recommendation K.11:1993, K.21:1996, K.27:1996, K.31:1993 and K.66:2004.</p>		N/A

IEC60950_1F - ATTACHMENT

Clause	Requirement + Test	Result - Remark	Verdict
--------	--------------------	-----------------	---------

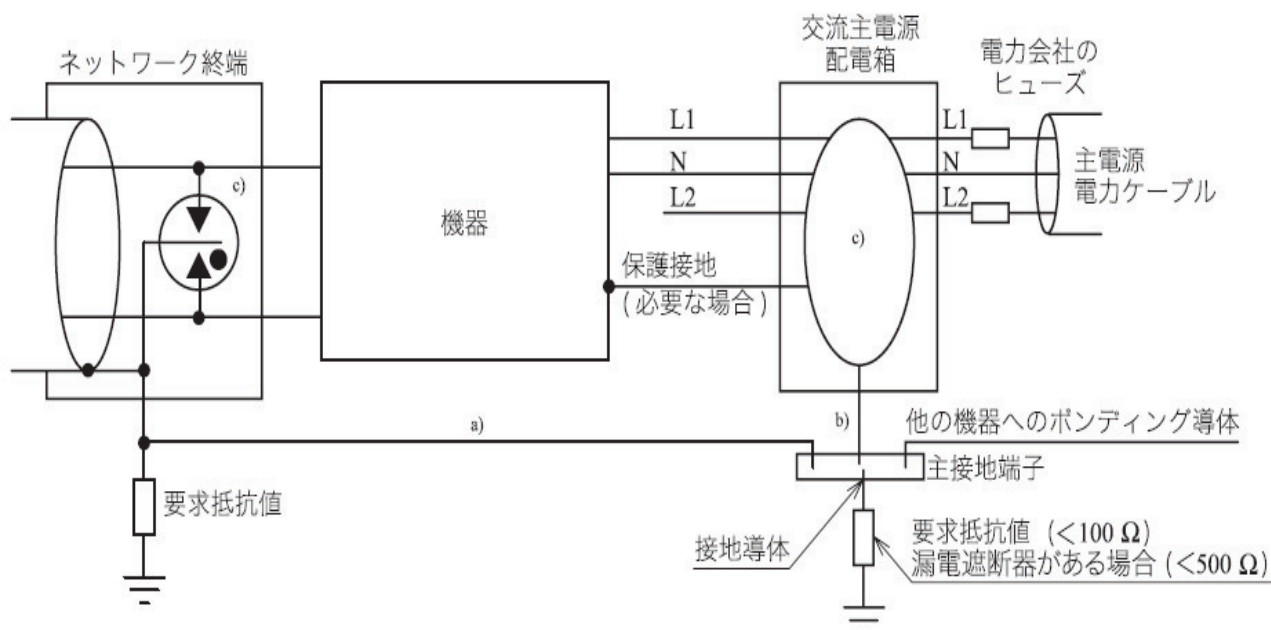

Note:

- All bonding line to a main grounding terminal makes it as short as possible (Less than 1.5m in the place that danger of direct lightning is high).
- The connected line which from SPD to main grounding terminal is as short as possible (less 1.5m).
- Setting for SPD (omitted the detail). All SPD connected line is short as possible (less 0.5m).

Figure JB.1 – Sample of desirable setting for TT electric power system of single phase three-wire type + neutral line
(From ITU-T Recommendation K.66:2004)

JB.2	<p>Situation and countermeasure of setting environment for overvoltage and overcurrent</p> <p>In Japan, TT type often adopted for electric power system. Typical example is as figure JB.2. For this TT type, on condition that it shall be an electric power system which does not wired with grounding conductor except neutral line, and it shall be connected with grounding terminal which have an electrically independent different from this grounding terminal of neutral line by user for equipment which need to connect with ground.</p>		N/A
------	---	--	-----

IEC60950_1F - ATTACHMENT

Clause	Requirement + Test	Result - Remark	Verdict
--------	--------------------	-----------------	---------

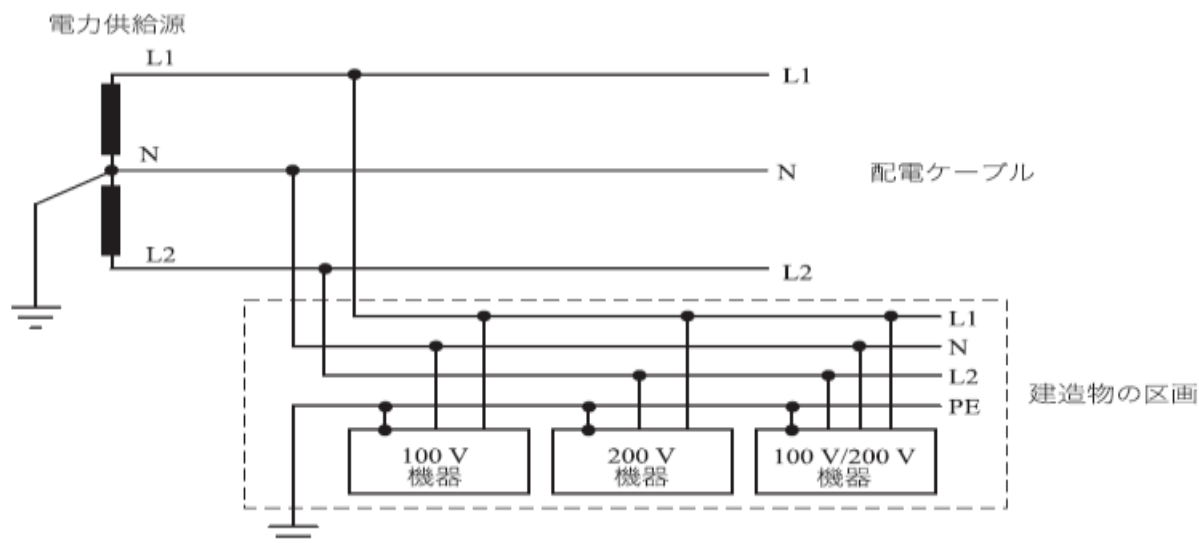

Grounded electric wire and grounded equipment in particularly

Figure JB.2 – Example of three-wire type TT electric power system

	<p>But as thing are stand, there are a lot of cases that an outlet is not prepared with the grounding terminal which is appropriate in the setting place of the equipment. On the other hand, grounding resistance value of SPD where set at lead-in point of communication line sometime is not enough low, it make that dielectric breakdown was occurred due to the voltage that a thunder surge current evoked for grounding resistance which flow into the communication line and drift to the ground through SPD. The same result is expected that grounding resistance value is not enough low too if set SPD on electric power system. This status is as figure JB.3.</p> <p>As figure JB.1, it can decrease effectively by connecting both with the conductor of the low resistance value when excessive potential difference occurred in internal equipment.</p>		N/A
--	--	--	-----

IEC60950_1F - ATTACHMENT

Clause	Requirement + Test	Result - Remark	Verdict
--------	--------------------	-----------------	---------

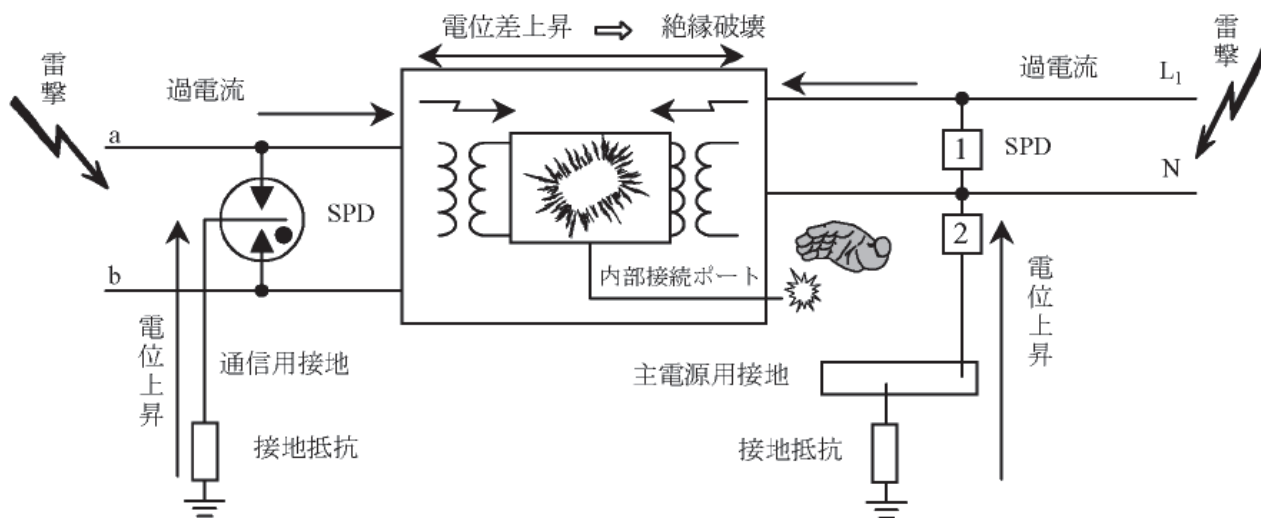

Figure JB.3 - Insufficient grounding and setting environment of bonding
 (From ITU-T Recommendation K.66:2004)

	<p>It is desirable that provide the information for set environment which appropriate measures were given based on ITU-T Recommendation K.11:1993 when perform design and sale network connected equipment.</p>		<p>N/A</p>
--	---	--	------------

IEC60950_1F - ATTACHMENT			
Clause	Requirement + Test	Result - Remark	Verdict
Appendix	Appendix 12, J3000(H25) Special National conditions, National deviation and other information according to MITI Ordinance No. 85.		—
1	General requirement When equipment provides with appliance inlet complying with JIS C 8283-1(2008), soldered parts of appliance inlet is not applied by force during insert or removal of connector. This is not applied when inlet body is fixed itself and not fixed by solder.	Inlet is fixed by adequate mechanical construction, not rely on soldering.	P
2	Requirement for equipment		—
2.1	Heater Appliances When diode is used in parallel at the power sources for adjustment of power consumption, the equipment shall remain safe for operation under open condition of one diode.		N/A
	The current rating of one diode shall be more than main current. The diodes connected in parallel are same type.		N/A
	The heating test specified by clause 11 of JIS C 9335-1(2003) and a specified in applicable individual requirements under open condition of one diode of parallel shall comply with the requirements.		N/A
2.2	Electric heater with glowing heating elements	Not electric stove.	N/A
	Surface treatment by paint or adhesive on protective frame or protective mesh shall not be used.		N/A
	Caution marking like below shall be on - easily visible place of the equipment or - Instruction manual 「注意 当該機器から、使用初期段階で揮発性有機化合物及びカルボニル化合物が最も放散するおそれがあるため、その際には十分換気を行うこと。」		N/A
3	Components used in equipment	No relevant equipment or component.	N/A
3.1	Motor capacitors used in ventilating fan, electric fan, air conditioner, electric washing machine, refrigerator or electric freezer shall be comply with - capacitors with protective elements or protective mechanism complying with JIS C 4908(2007) - P2 capacitor complying with IEC 60252-1(2001) Capacitor complying with below is acceptable		N/A
	Enclosed by metal or ceramic		N/A
	No non-metallic materials within 50 mm from capacitor surface		N/A

IEC60950_1F - ATTACHMENT			
Clause	Requirement + Test	Result - Remark	Verdict
	Non-metallic material within 50mm from capacitor surface comply with needle frame test of JIS C 9335-1(2003), Annex E		N/A
	Non-metallic material within 50 mm from capacitor surface comply with V-1 test of JIS C 60965-11-10(2006).		N/A
3.2	<p>Plug directly inserted to outlet used refrigerator or electric freezer.</p> <p>Shall comply with</p> <ul style="list-style-type: none"> - Face contact with outlet shall have CTI with more than 400 according to JIS C 2134(2007) or - Supporting material of blades shall comply with glow wire test by temperature of 750°C according to JIS C 60695-2-11(2004) or JIS C 60695-2-12(2004). <p>Materials having glow wire frame temperature of 775 °C are acceptable.</p>		N/A

IEC60950_1F - ATTACHMENT			
Clause	Requirement + Test	Result - Remark	Verdict
Appendix	J3000(H25) Interpretation for METI Ordinance of Technical Requirements (H26.04.14), Appendix 12		—
1	General requirement When equipment provides with appliance inlet complying with JIS C 8283-1(2008), soldered parts of appliance inlet is not applied by force during insert or removal of connector. This is not applied when inlet body is fixed itself and not fixed by solder.	Inlet is fixed by adequate mechanical construction, not rely on soldering only.	P
2	Requirement for equipment		—
2.1	Heater Appliances When diode is used in parallel for adjustment of power, the equipment shall remain safe for operation under open condition of one diode.	Not electric stove.	N/A
	The current rating of one diode shall be more than main current. The diodes connected in parallel are same type.		N/A
	The heating test specified by clause 11 of JIS C 9335-2-30(2006) under open condition of one diode shall comply with the requirements.		N/A
2.2	Electric heater with glowing heating elements	Not electric stove.	N/A
	Surface treatment by paint or adhesive on protective frame or protective mesh shall not be used.		N/A
	Caution marking like below shall be on - easily visible place of the equipment or - Instruction manual 「注意 当該機器から、使用初期段階で揮発性有機化合物及びカルボニル化合物が最も放散するおそれがあるため、その際には十分換気を行うこと。」		N/A
3	Components used in equipment	No such equipment /components.	N/A
3.1	Motor capacitors used in ventilating fan, electric fan, air conditioner, electric washing machine, refrigerator or electric freezer shall be comply with - capacitors with protective elements or protective mechanism complying with JIS C 4908(2007) - P2 capacitor complying with IEC 60252-1(2001) Capacitor complying with below is acceptable		N/A
	Enclosed by metal or ceramic		N/A
	No non-metallic materials within 50 mm from capacitor surface		N/A
	Non-metallic material within 50 mm from capacitor surface comply with needle frame test of JIS C 9335-1(2003), Annex E		N/A
	Non-metallic material within 50 mm from capacitor surface comply with V-1 test of JIS C 60965-11-		N/A

IEC60950_1F - ATTACHMENT			
Clause	Requirement + Test	Result - Remark	Verdict
	10(2006).		
3.2	<p>Plug directly inserted to outlet used refrigerator or electric freezer.</p> <p>Shall comply with</p> <ul style="list-style-type: none">- Face contact with outlet shall have CTI with more than 400 according to JIS C 2134(2007) or- Supporting material of blades shall comply with glow wire test by temperature of 750°C according to JIS C 60695-2-11(2004) or JIS C 60695-2-12(2004). <p>Materials having glow wire frame temperature of 775 °C are acceptable.</p>		N/A

National Differences			
Clause	Requirement - Test	Result - Remark	Verdict

APPENDIX ZZ
VARIATIONS TO IEC 60950-1, ED. 2.2 (2013) FOR
AUSTRALIA AND NEW ZEALAND

Differences according to.....: AS/NZS 60950.1:2015

ZZ1 INTRODUCTION

This Appendix sets out variations and additional requirements to cover issues which have not been addressed by the International Standard. These variations indicate national variations for purposes of the IECEE CB System and will be published in the IECEE CB Bulletin.

ZZ2 VARIATIONS

The following variations apply to the source text.

1.2	After definition 'PERSON, SERVICE' , insert the following new definition: POTENTIAL IGNITION SOURCE..... 1.2.12.201	Added.	P
1.2.12.201	After Clause 1.2.12.15, insert the following new clause: 1.2.12.201 POTENTIAL IGNITION SOURCE Possible fault which can start a fire if the open-circuit voltage measured across an interruption or faulty contact exceeds a value of 50 V (peak) a.c. or d.c. and the product of the peak value of this voltage and the measured r.m.s. current under normal operating conditions exceeds 15 VA. Such a faulty contact or interruption in an electrical connection includes those which may occur in CONDUCTIVE PATTERNS on PRINTED BOARDS. NOTE 1 An electronic protection circuit may be used to prevent such a fault from becoming a POTENTIAL IGNITION SOURCE. NOTE 2 This definition is from AS/NZS 60065:2012, Clause 2.8.11.	Added.	P
1.5.1	<ol style="list-style-type: none"> 1. First paragraph, insert the following text after the words 'IEC component standard': 'or the relevant Australian/New Zealand Standard.' 2. In the NOTE, insert the following text after the word 'standard': 'or an Australian/New Zealand Standard' 3. Second paragraph, delete the words 'without further evaluation'. 	<p>Added.</p> <p>Added.</p> <p>Deleted.</p>	P

National Differences																				
Clause	Requirement - Test	Result - Remark	Verdict																	
1.5.2	<ol style="list-style-type: none"> 1. First paragraph, insert the following text after the word 'standard': 'or an Australian/New Zealand Standard.' 2. First paragraph, second dash item, second line, insert the following text after the word 'standard': 'or an Australian/New Zealand Standard.' 3. First paragraph, second dash item, last line, Insert the following text after the word 'standard': 'or an Australian/New Zealand Standard.' 	Added.	P																	
1.7.1.3	<p>Delete existing text and replace with the following: Graphical symbols placed on the equipment as a requirement of this standard, shall be in accordance with IEC 60417 or ISO 3864-2 or ISO 7000, if available. In the absence of suitable symbols, the manufacturer may design specific graphical symbols. Symbols as required by this standard placed on the equipment shall be explained in the user manual.</p>	Replaced.	P																	
2.9.2	Second paragraph, delete the word 'designated'.	Deleted.	N/A																	
3.2.5.1 Table 3B	<p>Modify Table 3B as follows:</p> <ol style="list-style-type: none"> 1. Delete the first four rows and replace with the following: <table border="1"> <thead> <tr> <th rowspan="2">RATED CURRENT of equipment A</th> <th colspan="2">Minimum conductor sizes</th> </tr> <tr> <th>Nominal cross-sectional area mm²</th> <th>AWG or kcmil [cross-sectional area in mm²] see Note 2</th> </tr> </thead> <tbody> <tr> <td>Over 0.2 up to and including 3</td> <td>0,5 ^a</td> <td>18 [0,8]</td> </tr> <tr> <td>Over 3 up to and including 7.5</td> <td>0,75</td> <td>16 [1,3]</td> </tr> <tr> <td>Over 7.5 up to and including 10</td> <td>(0,75) ^b 1,00</td> <td>16 [1,3]</td> </tr> <tr> <td>Over 10 up to and including 16</td> <td>(1,0) ^c 1,5</td> <td>14 [2]</td> </tr> </tbody> </table> <ol style="list-style-type: none"> 2. Delete NOTE 1 and renumber existing NOTE 2 as 'NOTE'. 3. Delete Footnote ^a and replace with the following: ^a This nominal cross-sectional area is only allowed for Class II appliances if the length of the power supply cord, measured between the point where the cord, or cord guard, enters the appliance, and the entry to the plug does not exceed 2 m (0,5 mm² three-core supply flexible cords are not permitted; see AS/NZS 3191). 	RATED CURRENT of equipment A	Minimum conductor sizes		Nominal cross-sectional area mm ²	AWG or kcmil [cross-sectional area in mm ²] see Note 2	Over 0.2 up to and including 3	0,5 ^a	18 [0,8]	Over 3 up to and including 7.5	0,75	16 [1,3]	Over 7.5 up to and including 10	(0,75) ^b 1,00	16 [1,3]	Over 10 up to and including 16	(1,0) ^c 1,5	14 [2]	Modified.	N/A
RATED CURRENT of equipment A	Minimum conductor sizes																			
	Nominal cross-sectional area mm ²	AWG or kcmil [cross-sectional area in mm ²] see Note 2																		
Over 0.2 up to and including 3	0,5 ^a	18 [0,8]																		
Over 3 up to and including 7.5	0,75	16 [1,3]																		
Over 7.5 up to and including 10	(0,75) ^b 1,00	16 [1,3]																		
Over 10 up to and including 16	(1,0) ^c 1,5	14 [2]																		

National Differences			
Clause	Requirement - Test	Result - Remark	Verdict
4.1.201	<p>After Clause 4.1, insert new Clause 4.1.201 as follows:</p> <p>4.1.201 Display devices used for television purposes</p> <p>Display devices which may be used for television purposes, with a mass of 7 kg or more, shall comply with the requirements for stability and mechanical hazards, including the additional stability requirements for television receivers, specified in AS/NZS 60065.</p>	Inserted.	N/A
4.3.6	<p>Delete the third paragraph and replace with the following:</p> <p><i>Equipment with a plug portion, suitable for insertion into a 10 A 3-pin flatpin socket-outlet complying with AS/NZS 3112 shall comply with the requirements in AS/NZS 3112 for equipment with integral pins for insertion into socket-outlets.</i></p>	Deleted and replaced. Not direct plug-in type.	N/A
4.3.8	<p>Eighth paragraph, insert the following new note after the first dash item:</p> <p>NOTE 6.201 In cases where the voltage source is provided by power from an unassociated power source, consideration should be given to the effects of possible single fault conditions in the unassociated equipment. If the power source is unknown then it should be assumed that the maximum limit of SELV may be applied to the source input under assumed single fault conditions in the source when assessing the charging circuit in the equipment under test.</p>	No Batteries.	N/A
4.3.8.201	<p>After Clause 4.3.8, add the following new clause as follows:</p> <p>4.3.8.201 Products containing coin/button cell batteries and batteries designated R1</p> <p>The requirements of AS/NZS 60065:2012 Amendment 1:2015, Clause 14.10.201 apply for this Clause.</p>	No such Batteries.	N/A
4.3.13.5.1	<ol style="list-style-type: none"> Delete the first paragraph and replace with the following: Except as permitted below, equipment shall be classified and labelled according to IEC 60825-1 or AS/NZS 60825.1, IEC 60825-2 or AS/NZS 60825.2 and IEC 60825-12, as applicable. Third paragraph, first sentence, after 'IEC 60825-1', insert the following text: or AS/NZS 60825.1 Fourth paragraph, after 'IEC 60825-1', insert the following text: or AS/NZS 60825.1 	No Lasers.	N/A
4.7	<p>At the end of Clause 4.7, insert the following text: 'For alternate tests refer to Clause 4.7.201.'</p>	Added. The alternative method is not considered.	N/A

National Differences			
Clause	Requirement - Test	Result - Remark	Verdict
4.7.201	After Clause 4.7.3.6, add new Clauses as follows: 4.7.201 Resistance to fire – Alternative tests	Added. The alternative method is not considered.	N/A
4.7.201.1	<p>4.7.201.1 General</p> <p>Parts of non-metallic material shall be resistant to ignition and spread of fire.</p> <p>This requirement does not apply to decorative trims, knobs and other parts unlikely to be ignited or to propagate flames from inside the apparatus, or the following:</p> <p>(a) Components that are contained in an enclosure having a flammability category of V-0 according to AS/NZS 60695.11.10 and having openings only for the connecting wires filling the openings completely, and for ventilation not exceeding 1mm in width regardless of length.</p> <p>(b) The following parts which would contribute negligible fuel to a fire:</p> <ul style="list-style-type: none"> - small mechanical parts, the mass of which does not exceed 4g, such as mounting parts, gears, cams, belts and bearings; - small electrical components, such as capacitors with a volume not exceeding 1,750 mm³, integrated circuits, transistors and optocoupler packages, if these components are mounted on material of flammability category V-1, or better, according to AS/NZS 60695.11.10. <p>NOTE In considering how to minimize propagation of fire and what 'small parts' are, account should be taken of the cumulative effect of small parts adjacent to each other for the possible effect of propagating the fire from one part to another.</p> <p>Compliance shall be checked by the tests of 4.7.201.2, 4.7.201.3, 4.7.201.4 and 4.7.201.5.</p> <p>For the base material of printed boards, compliance shall be checked by the test of 4.7.201.5.</p> <p>The tests shall be carried out on parts of non-metallic material which have been removed from the apparatus. When the glow-wire test is carried out, the parts shall be placed in the same orientation as they would be in normal use.</p> <p>These tests are not carried out on internal wiring.</p>	Added. The alternative method is not considered.	N/A

National Differences													
Clause	Requirement - Test	Result - Remark	Verdict										
4.7.201.2	<p>4.7.201.2 Testing of non-metallic materials</p> <p>Parts of non-metallic material shall be subject to the glow-wire test of AS/NZS 60695.2.11 which shall be carried out at 550 °C.</p> <p>Parts for which the glow-wire test cannot be carried out, such as those made of soft or foamy material, shall meet the requirements specified in ISO 9772 for category FH-3 material. The glow-wire test shall be not carried out on parts of material classified at least FH-3 according to ISO 9772 provided that the sample tested was not thicker than the relevant part.</p>	Added. The alternative method is not considered.	N/A										
4.7.201.3	<p>4.7.201.3 Testing of insulating materials</p> <p>Parts of insulating material supporting POTENTIAL IGNITION SOURCES shall be subject to the glow-wire test of AS/NZS 60695.2.11 which shall be carried out at 750 °C.</p> <p>The test shall be also carried out on other parts of insulating material which are within a distance of 3 mm of the connection.</p> <p>NOTE Contacts in components such as switch contacts are considered to be connections.</p> <p>For parts which withstand the glow-wire test but produce a flame, other parts above the connection within the envelope of a vertical cylinder having a diameter of 20 mm and a height of 50 mm shall be subjected to the needle-flame test. However, parts shielded by a barrier which meets the needle-flame test shall not be tested.</p> <p>The needle-flame test shall be made in accordance with AS/NZS 60695.11.5 with the following modifications:</p> <table border="1"> <thead> <tr> <th>Clause of AS/NZS 60695.11.5</th> <th>Change</th> </tr> </thead> <tbody> <tr> <td>9 Test procedure</td> <td></td> </tr> <tr> <td>9.2 Application of needleflame</td> <td>Replace the first paragraph with: The specimen shall be arranged so that the flame can be applied to a vertical or horizontal edge as shown in the examples of figure 1. If possible the flame shall be applied at least 10 mm from a corner Replace the second paragraph with: The duration of application of the test flame shall be 30 s ±1 s.</td> </tr> <tr> <td>9.3 Number of test specimens</td> <td>Replace with: The test shall be made on one specimen. If the specimen does not withstand the test, the test may be repeated on two further specimens, both of which shall withstand the test.</td> </tr> <tr> <td>11 Evaluation of test results</td> <td>Replace with: The duration of burning (t_b) shall not exceed 30 s. However, for printed circuit boards, it shall not exceed 15 s.</td> </tr> </tbody> </table> <p>The needle-flame test shall not be carried out on</p>	Clause of AS/NZS 60695.11.5	Change	9 Test procedure		9.2 Application of needleflame	Replace the first paragraph with: The specimen shall be arranged so that the flame can be applied to a vertical or horizontal edge as shown in the examples of figure 1. If possible the flame shall be applied at least 10 mm from a corner Replace the second paragraph with: The duration of application of the test flame shall be 30 s ±1 s.	9.3 Number of test specimens	Replace with: The test shall be made on one specimen. If the specimen does not withstand the test, the test may be repeated on two further specimens, both of which shall withstand the test.	11 Evaluation of test results	Replace with: The duration of burning (t_b) shall not exceed 30 s. However, for printed circuit boards, it shall not exceed 15 s.	Added. The alternative method is not considered.	N/A
Clause of AS/NZS 60695.11.5	Change												
9 Test procedure													
9.2 Application of needleflame	Replace the first paragraph with: The specimen shall be arranged so that the flame can be applied to a vertical or horizontal edge as shown in the examples of figure 1. If possible the flame shall be applied at least 10 mm from a corner Replace the second paragraph with: The duration of application of the test flame shall be 30 s ±1 s.												
9.3 Number of test specimens	Replace with: The test shall be made on one specimen. If the specimen does not withstand the test, the test may be repeated on two further specimens, both of which shall withstand the test.												
11 Evaluation of test results	Replace with: The duration of burning (t_b) shall not exceed 30 s. However, for printed circuit boards, it shall not exceed 15 s.												

National Differences			
Clause	Requirement - Test	Result - Remark	Verdict
	parts of material classified as V-0 or V-1 according to AS/NZS 60695.11.10, provided that the sample tested was not thicker than the relevant part.		
4.7.201.4	<p>4.7.201.4 Testing in the event of non-extinguishing material</p> <p>If parts, other than enclosures, do not withstand the glow wire tests of 4.7.201.3, by failure to extinguish within 30 s after the removal of the glowwire tip, the needle-flame test detailed in 4.7.201.3 shall be made on all parts of non-metallic material which are within a distance of 50 mm or which are likely to be impinged upon by flame during the tests of 4.7.201.3. Parts shielded by a separate barrier which meets the needle-flame test need not be tested.</p> <p>NOTE 1 If the enclosure does not withstand the glow-wire test the equipment is considered to have failed to meet the requirements of Clause 4.7.201 without the need for consequential testing.</p> <p>NOTE 2 If other parts do not withstand the glow-wire test due to ignition of the tissue paper and if this indicates that burning or glowing particles can fall onto an external surface underneath the equipment, the equipment is considered to have failed to meet the requirements of Clause 4.7.201 without the need for consequential testing.</p> <p>NOTE 3 Parts likely to be impinged upon by the flame are considered to be those within the envelope of a vertical cylinder having a radius of 10 mm and a height equal to the height of the flame, positioned above the point of the material supporting, in contact with, or in close proximity to, connections.</p>	Added. The alternative method is not considered.	N/A

National Differences			
Clause	Requirement - Test	Result - Remark	Verdict
4.7.201.5	<p>4.7.201.5 Testing of printed boards</p> <p>The base material of printed boards shall be subjected to the needle-flame test of Clause 4.7.201.3. The flame shall be applied to the edge of the board where the heat sink effect is lowest when the board is positioned as in normal use. The flame shall not be applied to an edge, consisting of broken perforations, unless the edge is less than 3 mm from a POTENTIAL IGNITION SOURCE.</p> <p>The test is not carried out if the —</p> <ul style="list-style-type: none"> - Printed board does not carry any POTENTIAL IGNITION SOURCE; - Base material of printed boards, on which the available apparent power at a connection exceeds 15 VA operating at a voltage exceeding 50 V and equal or less than 400 V (peak) a.c. or d.c. under normal operating conditions, is of flammability category V-1 or better according to AS/NZS 60695.11.10, or the printed boards are protected by an enclosure meeting the flammability category V-0 according to AS/NZS 60695.11.10, or made of metal, having openings only for connecting wires which fill the openings completely; or - Base material of printed boards, on which the available apparatus power at a connection exceeds 15 VA operating at a voltage exceeding 400 V (peak) a.c. or d.c. under normal operating conditions, and base material of printed boards supporting spark gaps which provides protection against overvoltages, is of flammability category V-0 according to AS/NZS 60695.11.10 or the printed boards are contained in a metal enclosure, having openings only for connecting wires which fill the openings completely. <p>Compliance shall be determined using the smallest thickness of the material.</p> <p>NOTE Available apparent power is the maximum apparent power which can be drawn from the supplying circuit through a resistive load whose value is chosen to maximise the apparent power for more than 2 min when the circuit supplied is disconnected.</p>	Added. The alternative method is not considered.	N/A
6.2.2	<p>For Australia only, delete the first paragraph and Note, and replace with the following:</p> <p>In Australia only, compliance with 6.2.2 shall be checked by the tests of both 6.2.2.1 and 6.2.2.2.</p>	No TNV.	N/A

National Differences			
Clause	Requirement - Test	Result - Remark	Verdict
6.2.2.1	<p>For Australia only, delete the first paragraph including the Notes, and replace with the following:</p> <p><i>In Australia only, the electrical separation is subjected to 10 impulses of alternating polarity, using the impulse test generator reference 1 of Table N.1. The interval between successive impulses is 60 s and the initial voltage, U_c, is:</i></p> <p><i>(i) for 6.2.1 a): 7.0 kV for hand-held telephones and for headsets and 2.5 kV for other equipment; and</i></p> <p><i>(ii) for 6.2.1 b) and 6.2.1 c): 1.5 kV.</i></p> <p>NOTE 201 The 7 kV impulse simulates lightning surges on typical rural and semi-rural network lines.</p> <p>NOTE 202 The value of 2.5 kV for 6.2.1 a) was chosen to ensure the adequacy of the insulation concerned and does not necessarily simulate likely overvoltages.</p>	No TNV.	N/A
6.2.2.2	<p>For Australia only, delete the second paragraph including the Note, and replace with the following:</p> <p><i>In Australia only, the a.c. test voltage is:</i></p> <p><i>(i) for 6.2.1 a): 3 kV; and</i></p> <p><i>(ii) for 6.2.1 b) and 6.2.1 c): 1.5 kV.</i></p> <p>NOTE 201 Where there are capacitors across the insulation under test, it is recommended that d.c. test voltages are used.</p> <p>NOTE 202 The 3 kV and 1.5 kV values have been determined considering the low frequency induced voltages from the power supply distribution system.</p>	No TNV.	N/A
7.3	<p>Add the following before the first paragraph:</p> <p>Equipment providing functions that fall only within the scope of AS/NZS 60065 and that incorporate a PSTN interface, are not required to comply with this Clause where the only ports provided on the equipment, in addition to a coaxial cable connection and a PSTN interface, are audio or video ports and analogue or data ports not intended to be used for telecommunications purposes.</p>	No cable distribution systems.	N/A
Annex P	<p>Add the following Normative References:</p> <p>AS/NZS 3191, Electric flexible cords</p> <p>AS/NZS 3112, Approval and test specification—Plugs and socket-outlets</p>	Added.	P

National Differences			
Clause	Requirement - Test	Result - Remark	Verdict
Index	<p>1. Insert the following between 'asbestos, not to be used as insulation' and 'attitude see orientation':</p> <p>AS/NZS 3112 4.3.6</p> <p>AS/NZS 3191 3.2.5.1 (Table 3B)</p> <p>AS/NZS 60064 4.1.201</p> <p>AS/NZS60695.2.11 4.7.201.2, 4.7.201.3</p> <p>AS/NZS 60695.11.104.7.201.1, 4.7.201.5</p> <p>AS/NZS 60695.11.5 4.7.201.3</p> <p>AS/NZS 60825.1 4.3.13.5.1</p> <p>AS/NZS 60825.2 4.3.13.5.1</p> <p>2. Insert the following between 'positive temperature coefficient (PTC) device' and 'powder':</p> <p>Potential ignition source</p> <p>..... 1.2.201, 4.7.201.3, 4.7.201.5</p>	Inserted.	N/A

Type Designation: 238LM000**, **2490*****; 270LM000**, **2790*****
(* can be 0-9, A-Z, a-z, "+", "-", "/", "\" or blank,
Represent different enclosure color and sales region for
marketing purpose. No technology differences)

Report Number: 17059694 001



Figure 1. Front view with base type A



Figure 2. Rear view with base type A

Type Designation: 238LM000**, **2490*****, 270LM000**, **2790****
(* can be 0-9, A-Z, a-z, "+", "-", "/", "\" or blank,
Represent different enclosure color and sales region for
marketing purpose. No technology differences)

Report Number: 17059694 001



Figure 3. Front view with base type B



Figure 4. Rear view with base type A

Type Designation: 238LM000**, **2490*****; 270LM000**, **2790*****
(* can be 0-9, A-Z, a-z, "+", "-", "/", "\" or blank,
Represent different enclosure color and sales region for
marketing purpose. No technology differences)

Report Number: 17059694 001



Figure 5. Metal enclosure type A

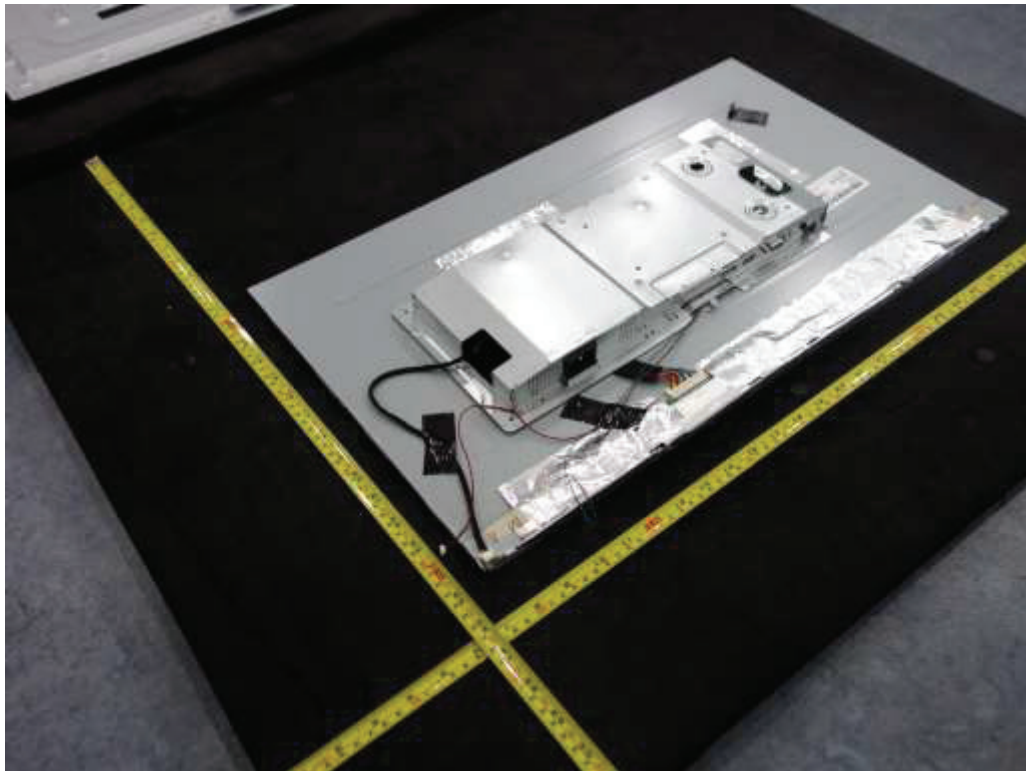

Figure 6. Metal enclosure type A

Type Designation: 238LM000**, **2490****; 270LM000**, **2790****
(* can be 0-9, A-Z, a-z, "+", "-", "/", "\" or blank,
Represent different enclosure color and sales region for
marketing purpose. No technology differences)

Report Number: 17059694 001

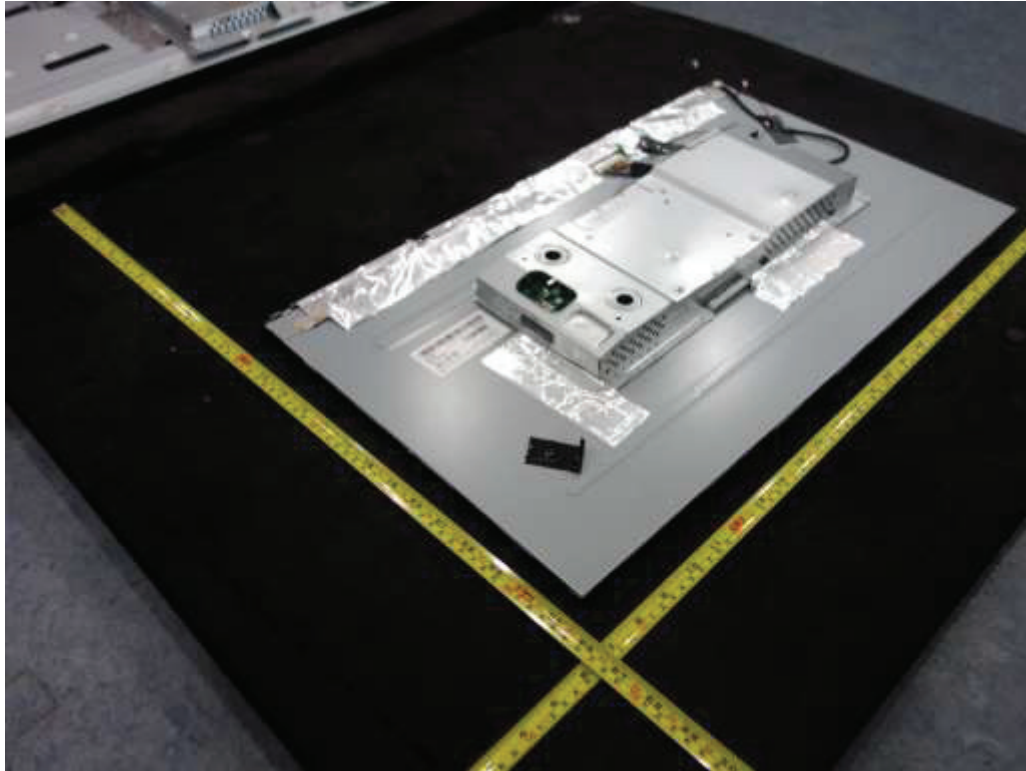

Figure 7. Metal enclosure type A

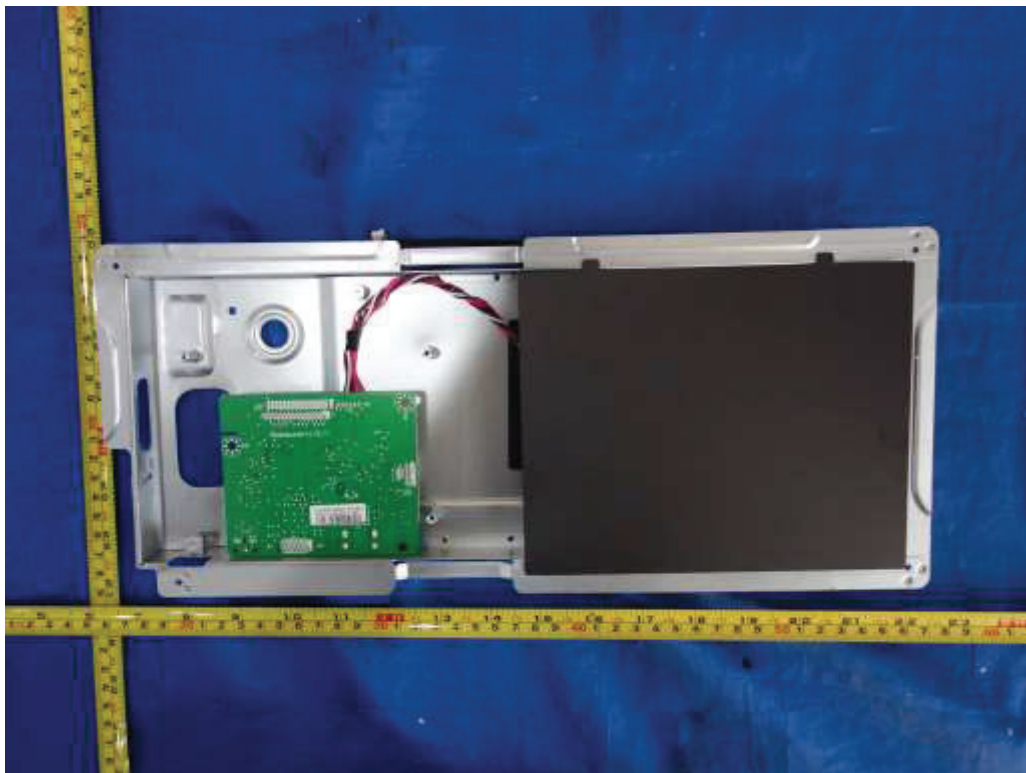

Figure 8. Internal view of metal enclosure type A

Type Designation: 238LM000**, **2490****; 270LM000**, **2790****
(* can be 0-9, A-Z, a-z, "+", "-", "/", "\" or blank,
Represent different enclosure color and sales region for
marketing purpose. No technology differences)

Report Number: 17059694 001

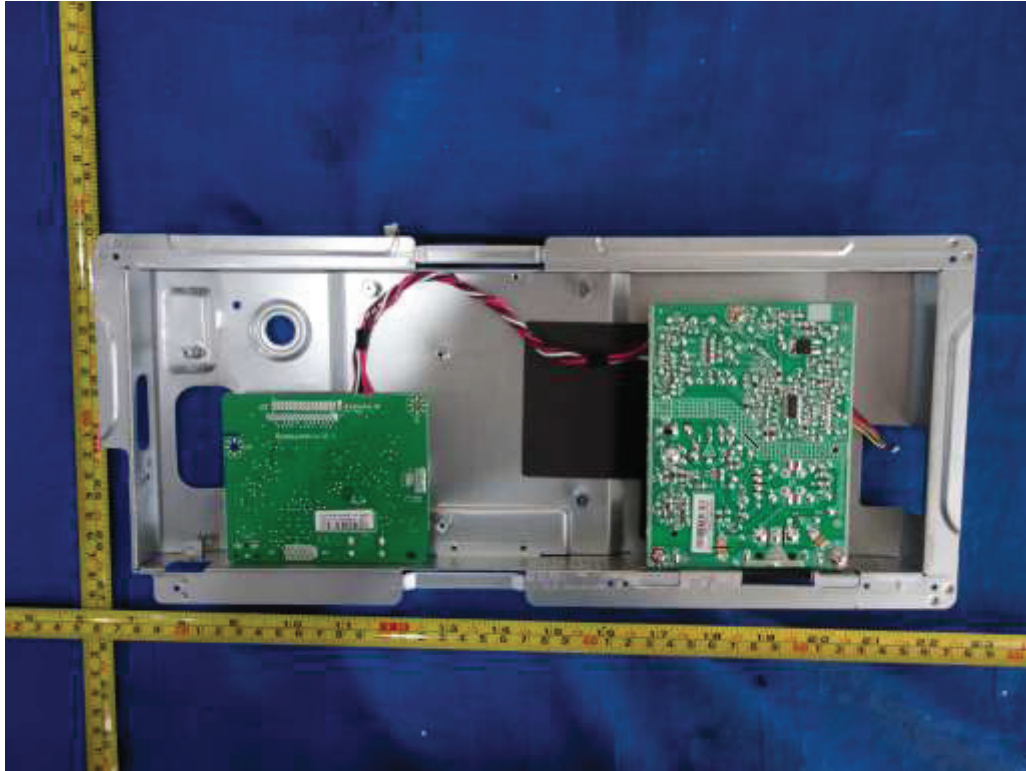

Figure 9. Internal view of metal enclosure type A

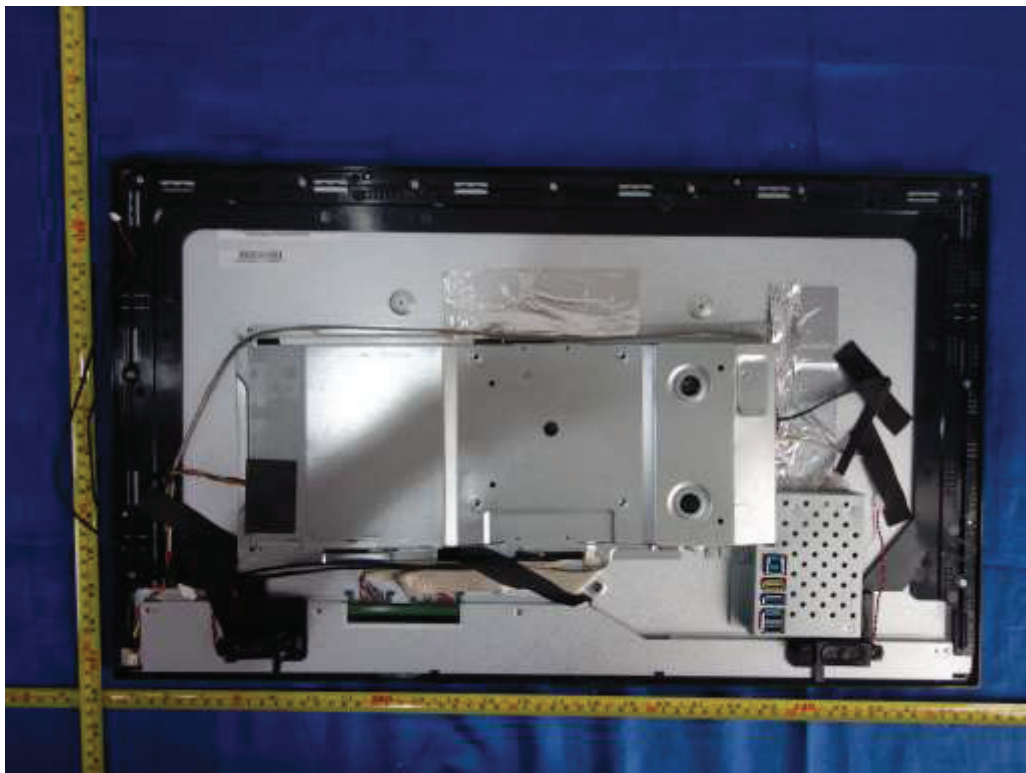

Figure 10. Metal enclosure type B

Type Designation: 238LM000**, **2490*****, 270LM000**, **2790****
(* can be 0-9, A-Z, a-z, "+", "-", "/", "\" or blank,
Represent different enclosure color and sales region for
marketing purpose. No technology differences)

Report Number: 17059694 001

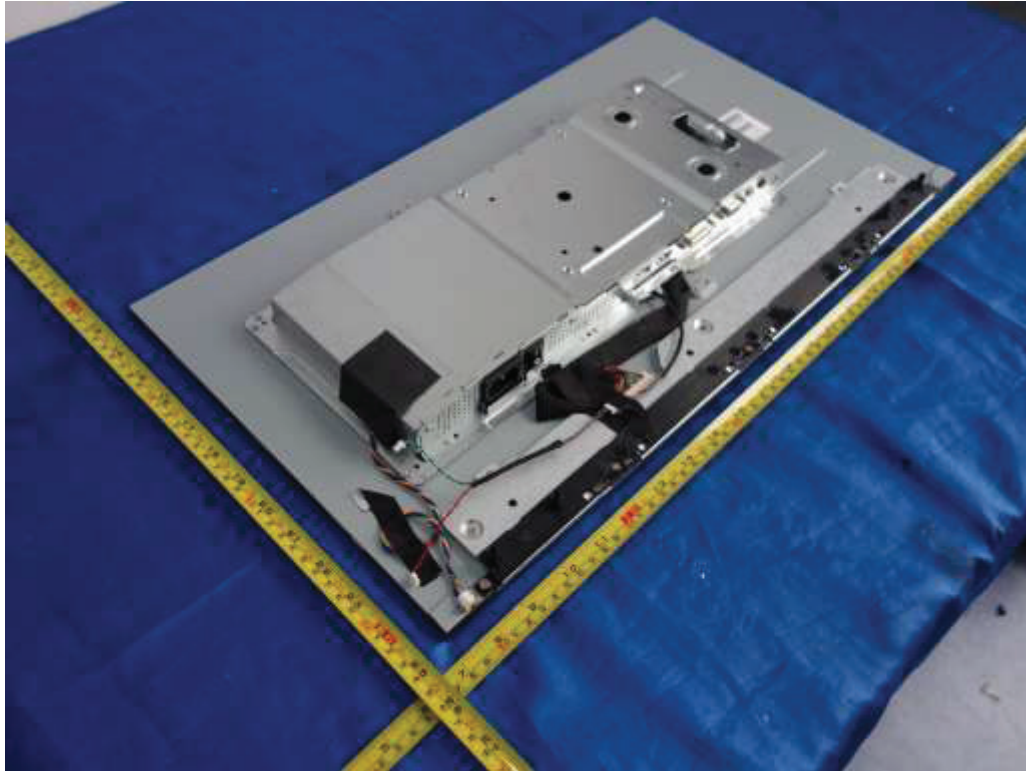

Figure 11. Metal enclosure type B

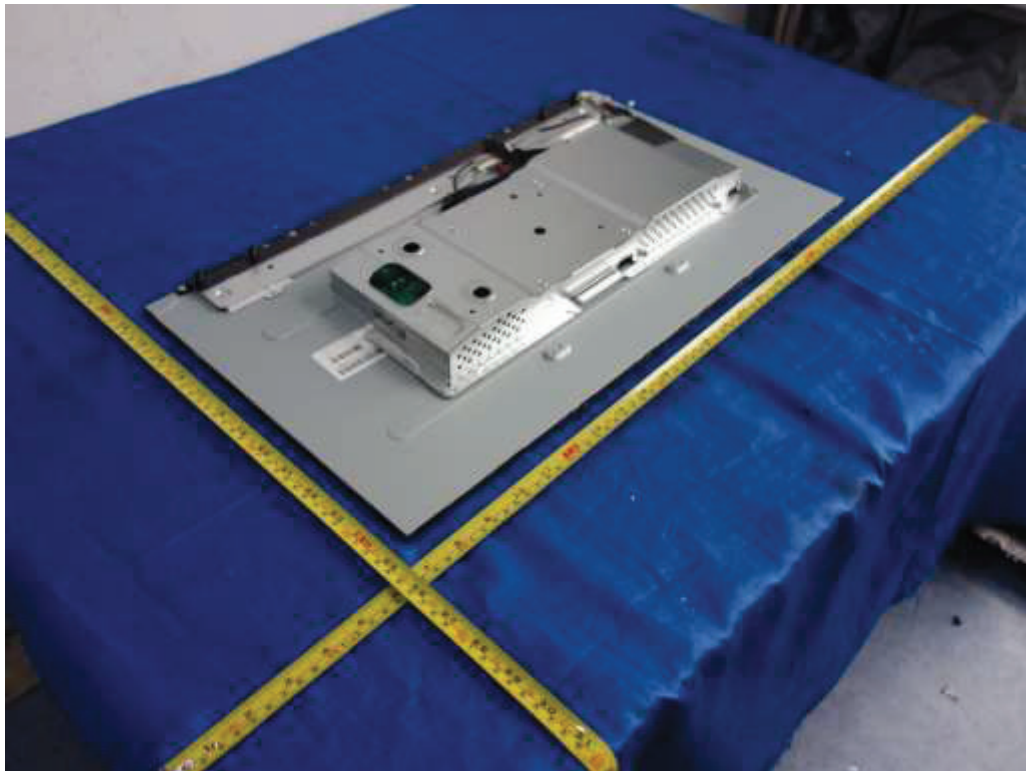

Figure 12. Metal enclosure type B

Type Designation: 238LM000**, **2490*****; 270LM000**, **2790*****
(* can be 0-9, A-Z, a-z, "+", "-", "/", "\" or blank,
Represent different enclosure color and sales region for
marketing purpose. No technology differences)

Report Number: 17059694 001

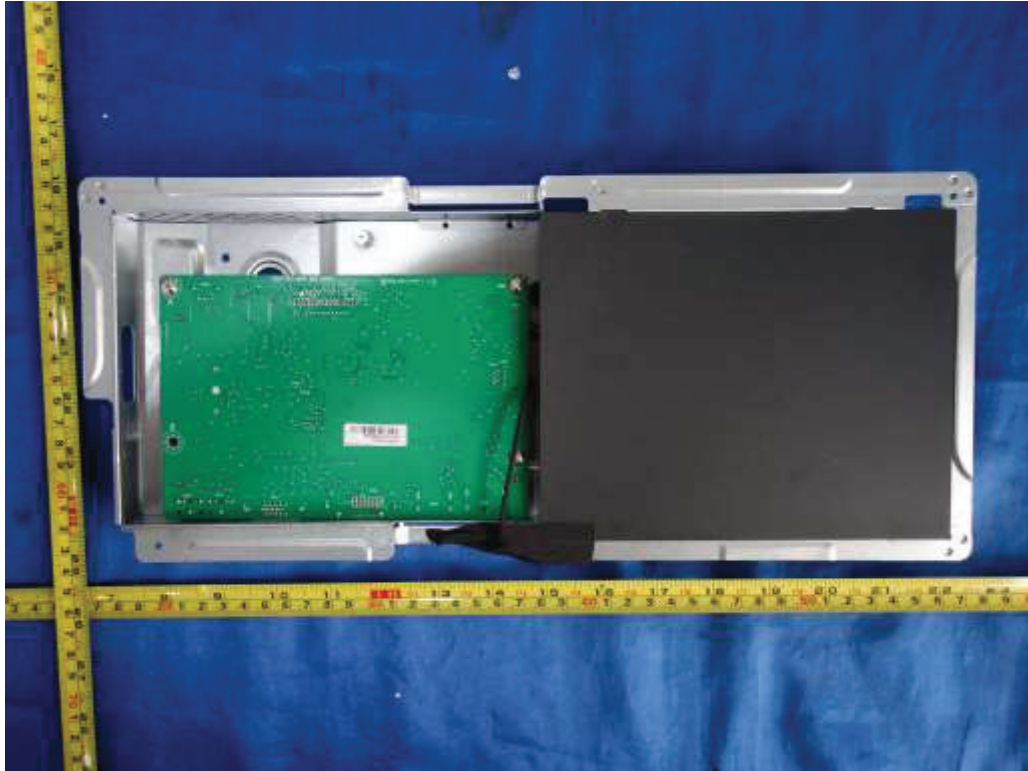

Figure 13. Metal enclosure type B

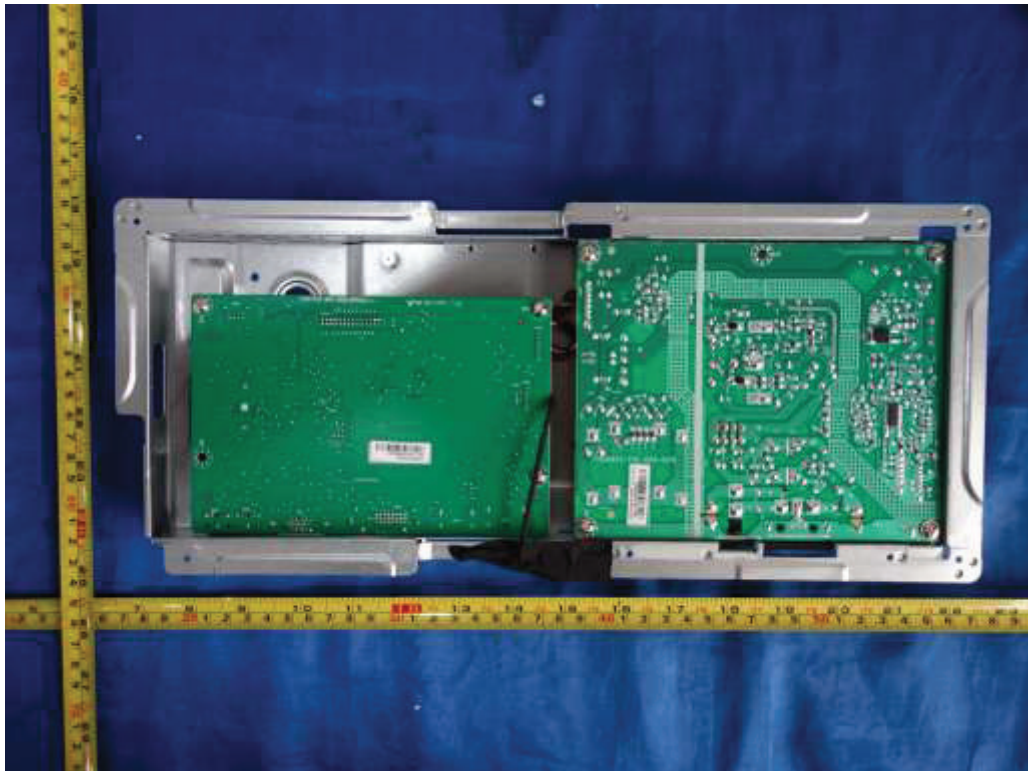

Figure 14. Metal enclosure type B

Type Designation: 238LM000**, **2490*****; 270LM000**, **2790*****
(* can be 0-9, A-Z, a-z, "+", "-", "/", "\" or blank,
Represent different enclosure color and sales region for
marketing purpose. No technology differences)

Report Number: 17059694 001

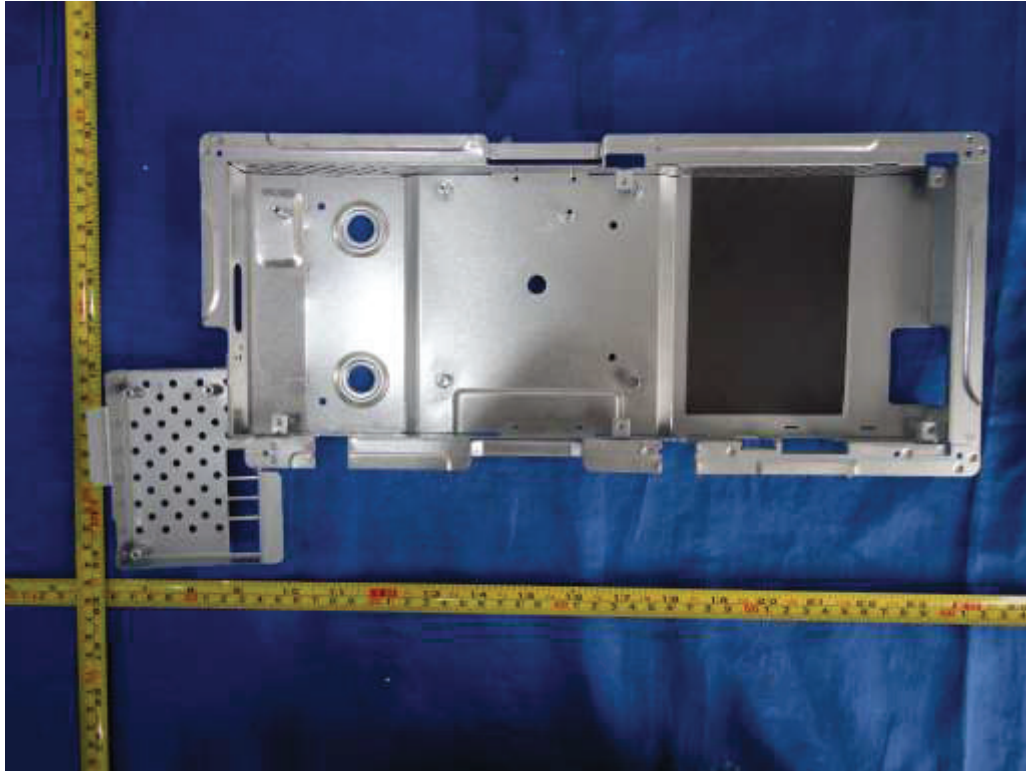

Figure 15. Metal enclosure type B

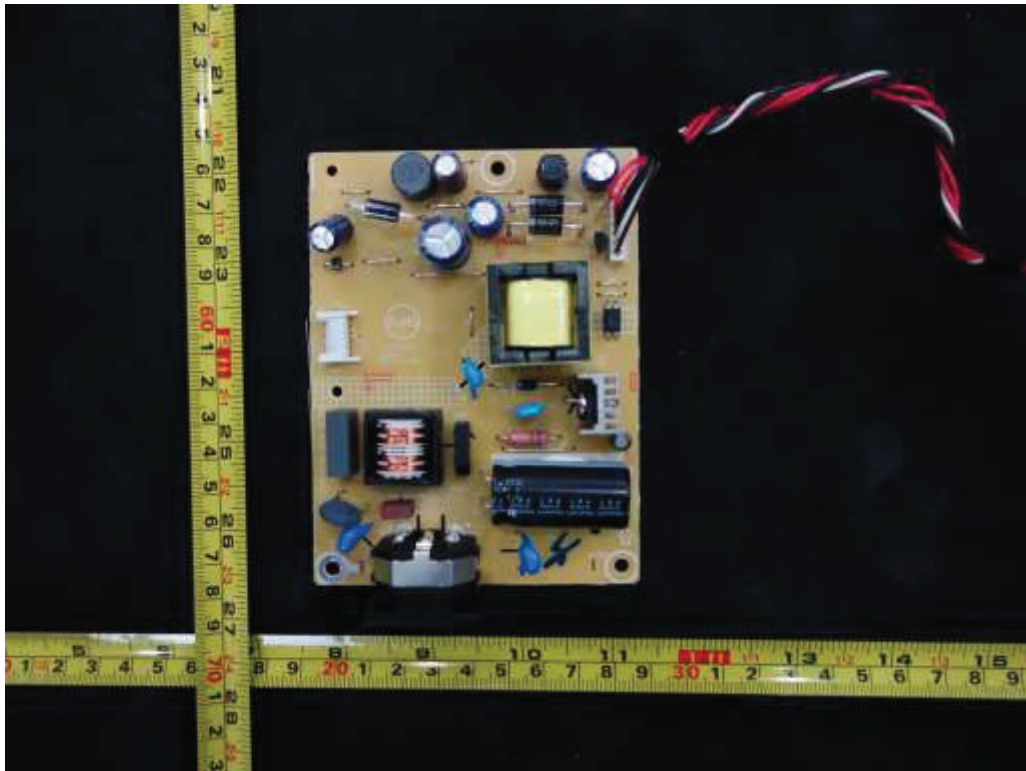

Figure 16. Power board 715G7300

Type Designation: 238LM000**, **2490*****; 270LM000**, **2790*****
(* can be 0-9, A-Z, a-z, "+", "-", "/", "\" or blank,
Represent different enclosure color and sales region for
marketing purpose. No technology differences)

Report Number: 17059694 001

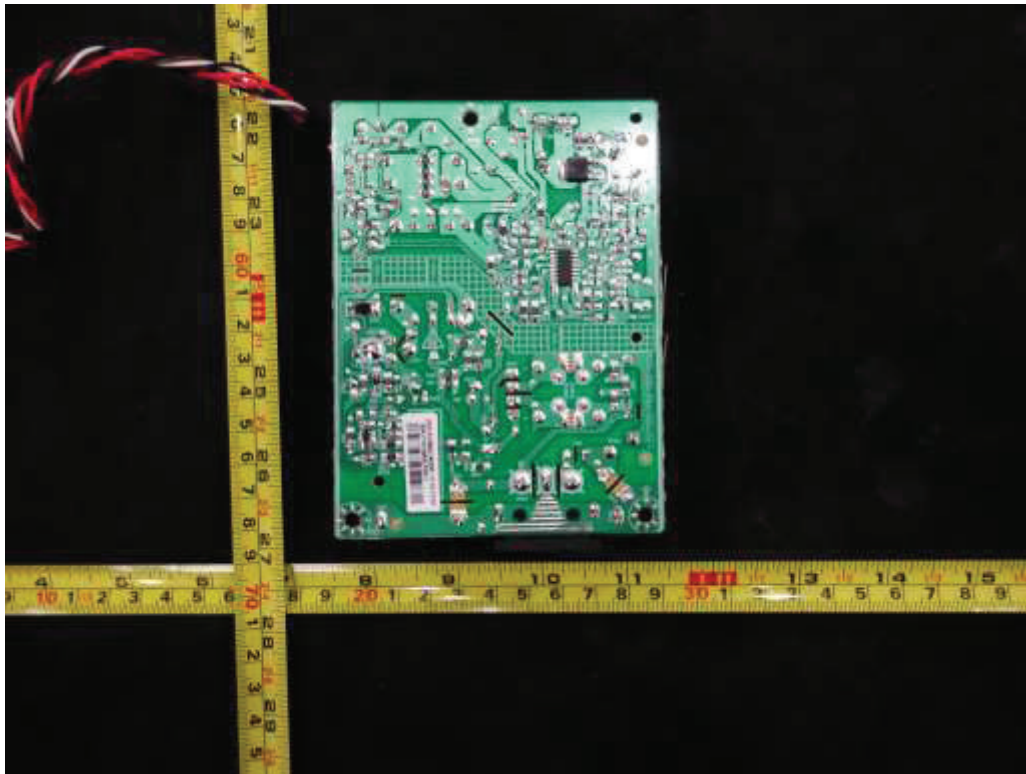

Figure 17. Power board 715G7300

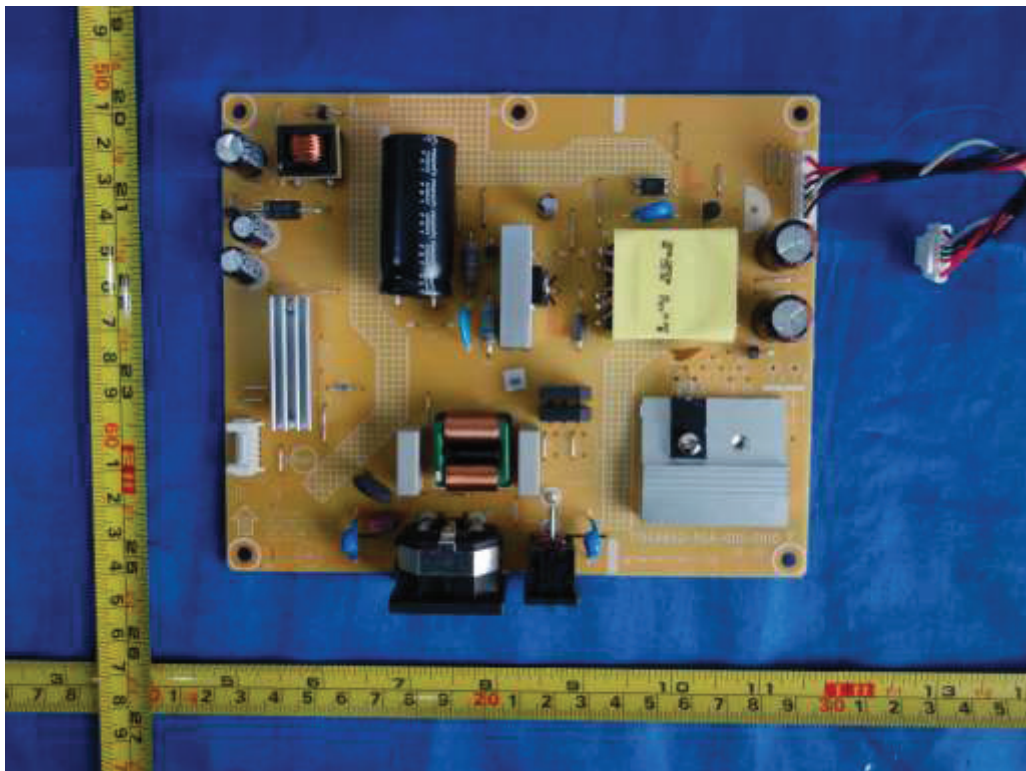

Figure 18. Power board 715G8522 type A

Type Designation: 238LM000**, **2490*****; 270LM000**, **2790*****
(* can be 0-9, A-Z, a-z, "+", "-", "/", "\" or blank,
Represent different enclosure color and sales region for
marketing purpose. No technology differences)

Report Number: 17059694 001

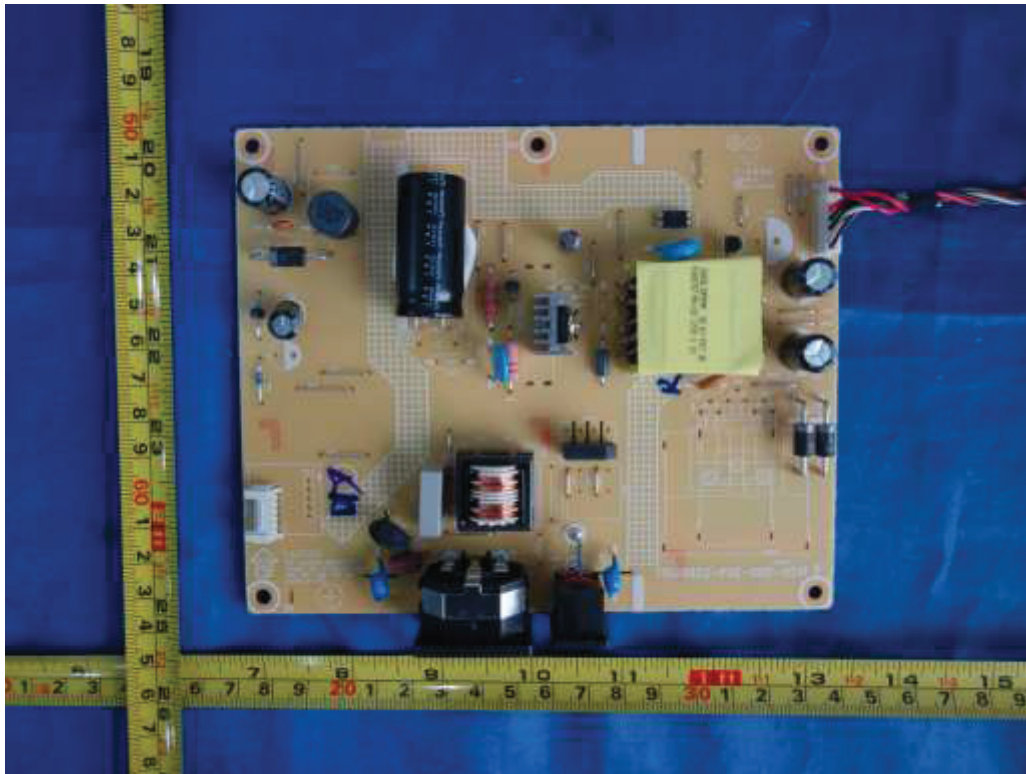

Figure 19. Power board 715G8522 type B

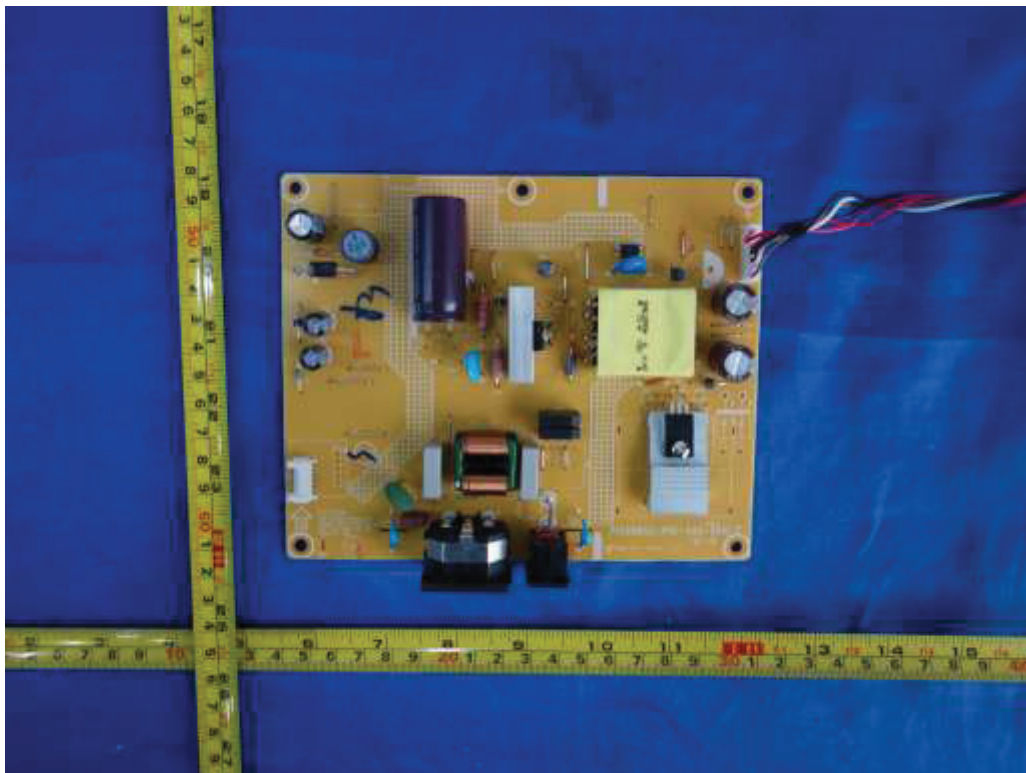

Figure 20. Power board 715G8522 type C

Type Designation: 238LM000**, **2490****; 270LM000**, **2790****
(* can be 0-9, A-Z, a-z, "+", "-", "/", "\" or blank,
Represent different enclosure color and sales region for
marketing purpose. No technology differences)

Report Number: 17059694 001

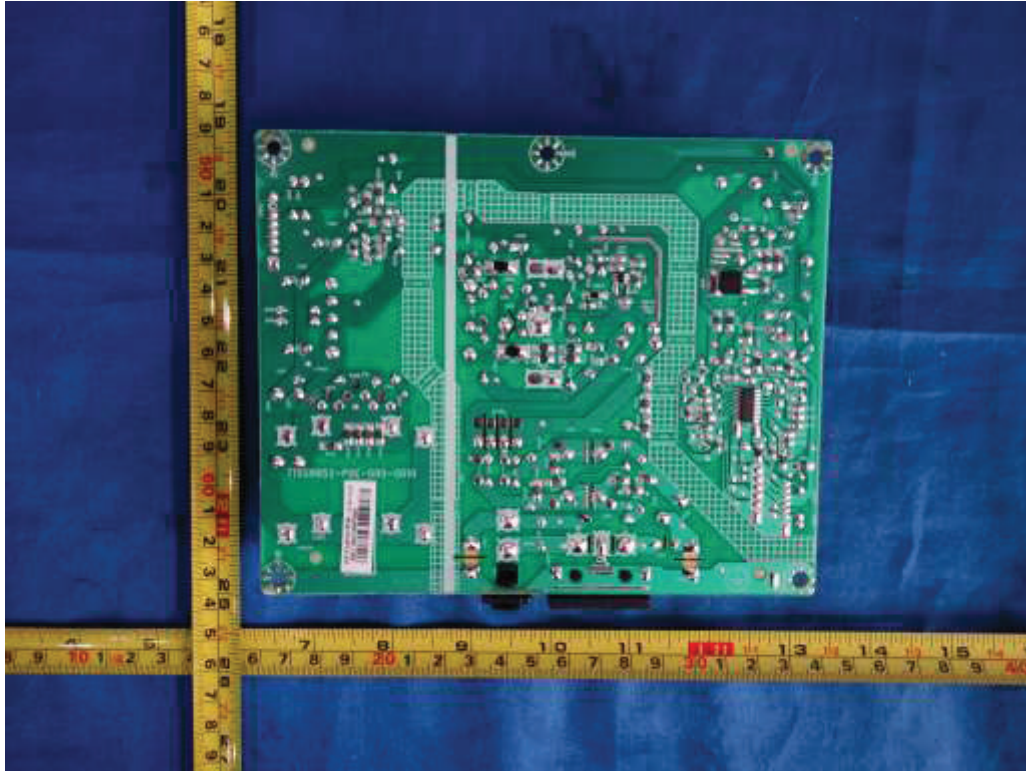

Figure 21. Power board 715G8522



Figure 22. Main board 715G8776

Type Designation: 238LM000**, **2490****; 270LM000**, **2790****
(* can be 0-9, A-Z, a-z, "+", "-", "/", "\" or blank,
Represent different enclosure color and sales region for
marketing purpose. No technology differences)

Report Number: 17059694 001

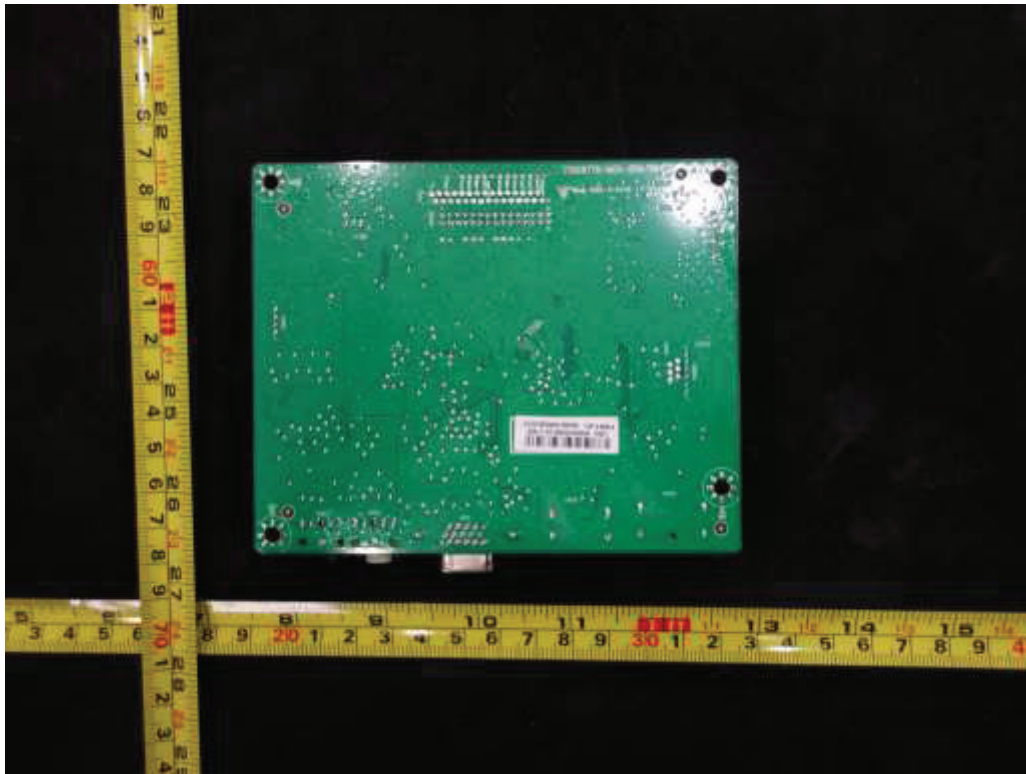

Figure 23. Main board 715G8776

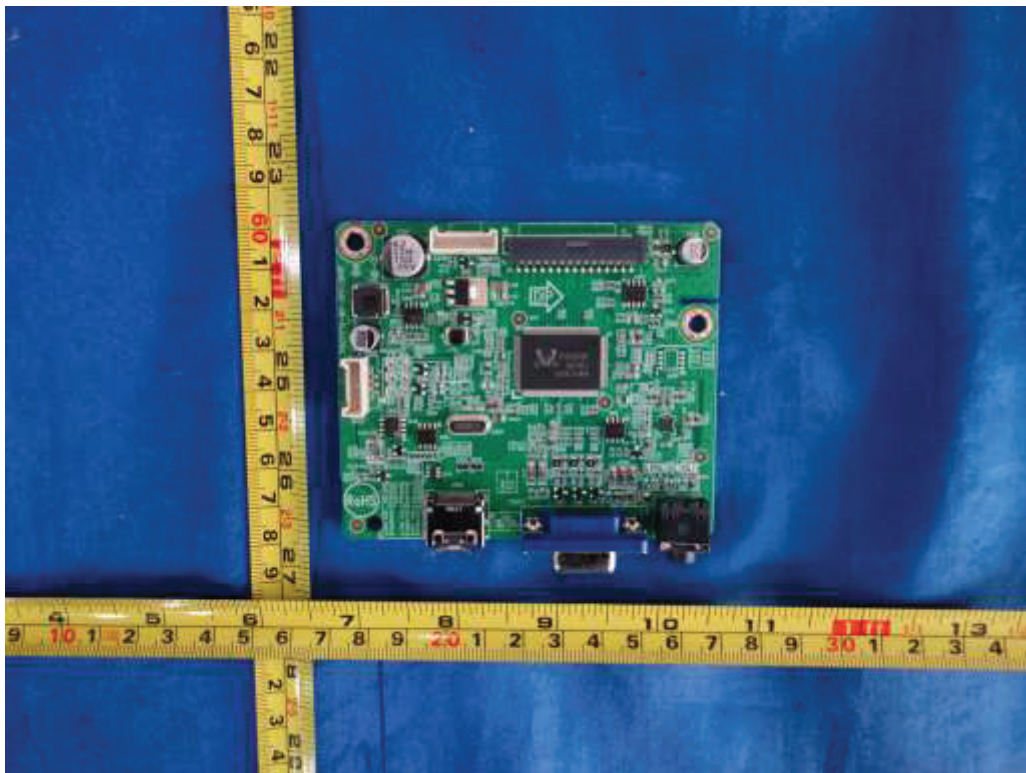

Figure 24. Main board 715G7778

Type Designation: 238LM000**, **2490****; 270LM000**, **2790****
(* can be 0-9, A-Z, a-z, "+", "-", "/", "\" or blank,
Represent different enclosure color and sales region for
marketing purpose. No technology differences)

Report Number: 17059694 001

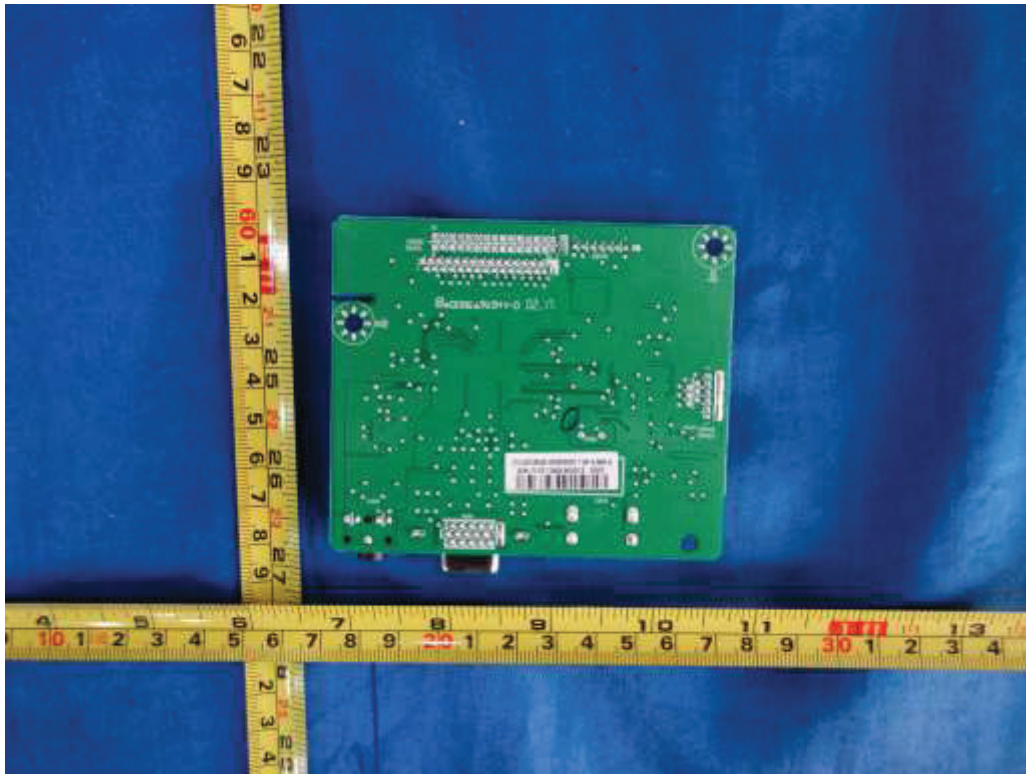

Figure 25. Main board 715G7778

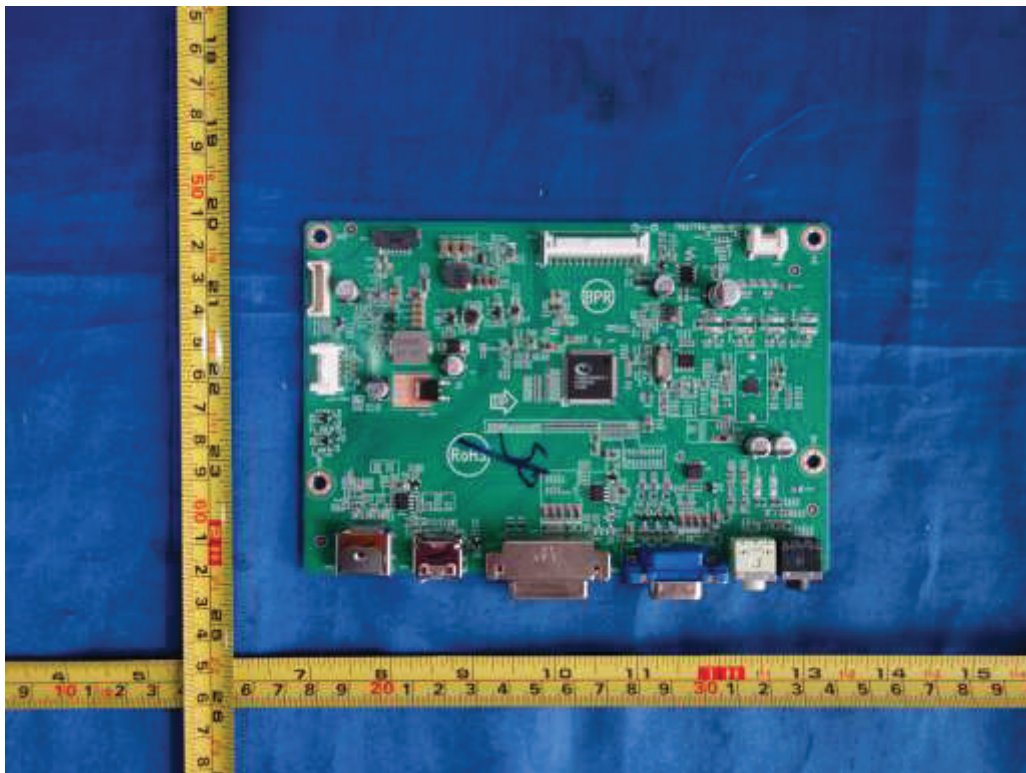

Figure 26. Main board 715G7762

Type Designation: 238LM000**, **2490****; 270LM000**, **2790****
(* can be 0-9, A-Z, a-z, "+", "-", "/", "\" or blank,
Represent different enclosure color and sales region for
marketing purpose. No technology differences)

Report Number: 17059694 001

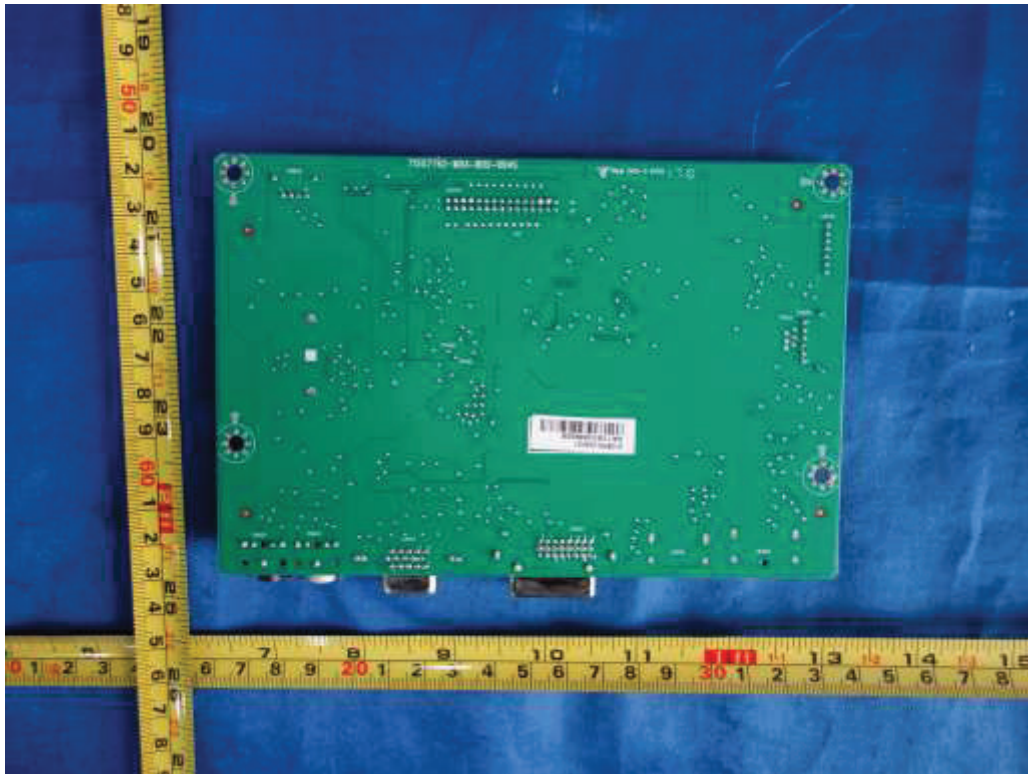

Figure 27. Main board 715G7762

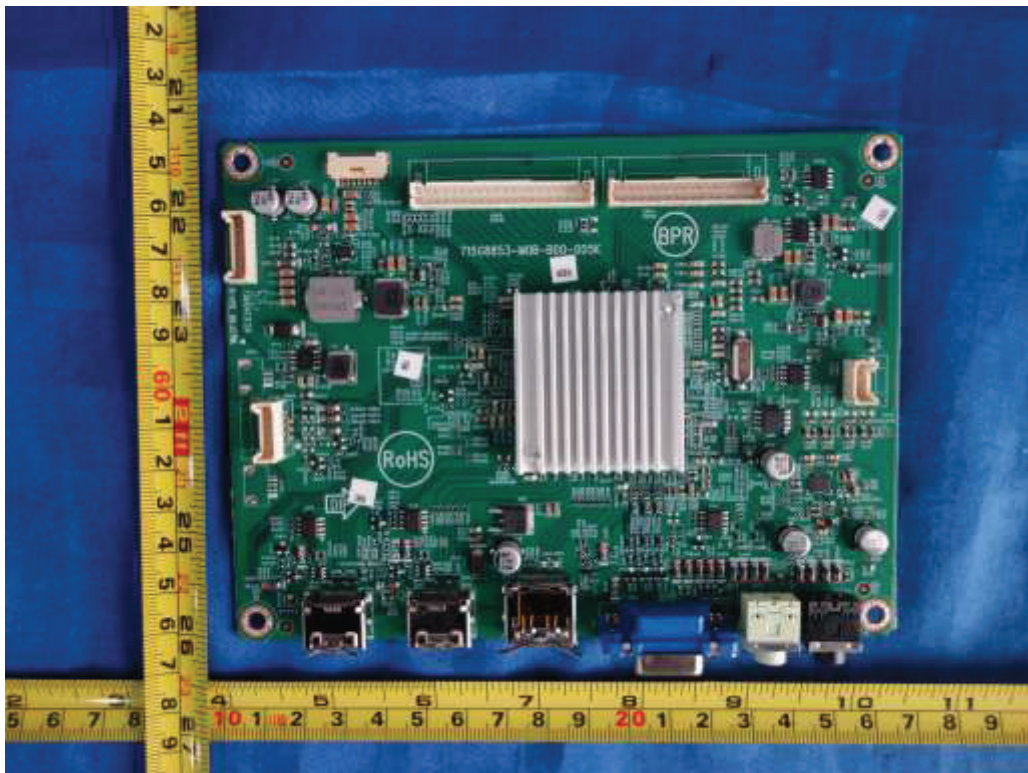

Figure 28. Main board 715G8853

Type Designation: 238LM000**, **2490*****; 270LM000**, **2790*****
(* can be 0-9, A-Z, a-z, "+", "-", "/", "\" or blank,
Represent different enclosure color and sales region for
marketing purpose. No technology differences)

Report Number: 17059694 001



Figure 29. Main board 715G8853

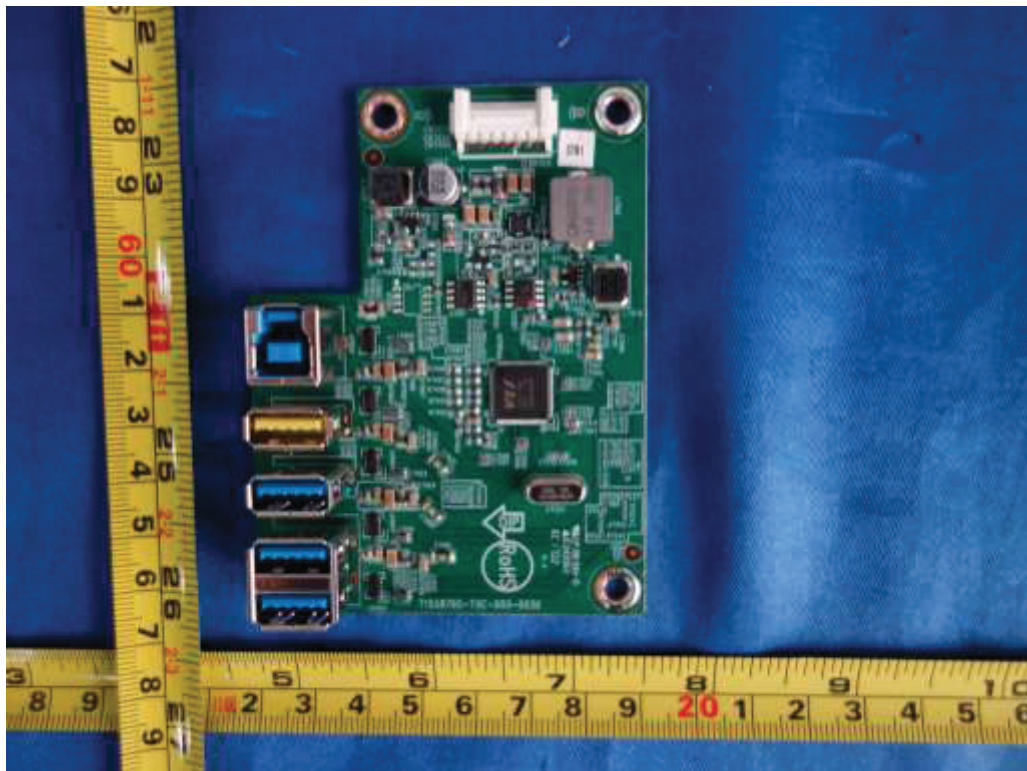

Figure 30. USB board 715G8765

Type Designation: 238LM000**, **2490****; 270LM000**, **2790****
(* can be 0-9, A-Z, a-z, "+", "-", "/", "\" or blank,
Represent different enclosure color and sales region for
marketing purpose. No technology differences)

Report Number: 17059694 001

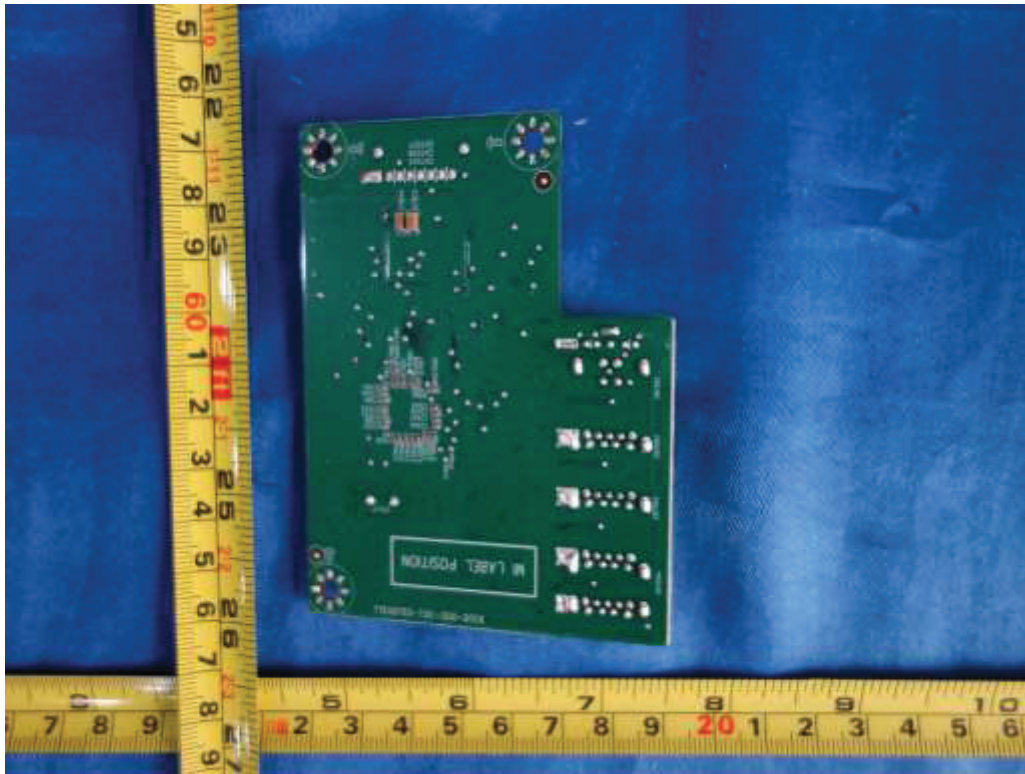

Figure 31. USB board 715G8765