



EMC TEST REPORT

Authorized under Declaration of Conformity

According to

EN 55032: 2012+AC 2013 (Class B)	EN 55024 : 2010
EN 61000-3-2 : 2014	IEC 61000-4-2 : 2008
EN 61000-3-3 : 2013	IEC 61000-4-3 : 2006+A1:2007+A2:2010
CISPR 32 : 2015	IEC 61000-4-4 : 2012
AS/NZS CISPR 32 : 2013	IEC 61000-4-5 : 2014
	IEC 61000-4-6 : 2013
	IEC 61000-4-8 : 2009
	IEC 61000-4-11 : 2004

Applicant	: TPV Electronics (Fujian) Co., Ltd.
Address	: Rongqiao Economic and Technological Development Zone, Fuqing City, Fujian Province, P.R. China
Equipment	: LCD Monitor 270LM00043, **2790****
Model No.	: (The "*" could be any alphanumeric character including blank for marketing differentiation.)

I HEREBY CERTIFY THAT :

The sample was received on May 10, 2017 and the testing was carried out on May 17, 2017 at CerpPASS Technology Corp. The test result refers exclusively to the test presented test model / sample. Without written approval of CerpPASS Technology Corp., the test report shall not be reproduced except in full.



EMC TEST REPORT

Issued by:

CerpPASS Technology (Suzhou) Co.,Ltd

No.66,Tangzhuang Road, Suzhou Industrial Park, Jiangsu 215006, China

Tel:86-512-6917-5888

Fax:86-512-6917-5666

The test record, data evaluation & Equipment Under Test configurations represented herein are true and accurate accounts of the measurements of the samples EMC characteristics under the conditions specified in this report.

The above equipment was tested by CerpPASS Technology Corp. for compliance with the requirements of technical standards specified above under the EMC Directive. The results of testing in this report apply only to the product/system, which was tested. Other similar equipment will not necessarily produce the same results due to production tolerance and measurement uncertainties

Approved by:

Miro Chueh
EMC/RF B.U. Manager

Laboratory Accreditation:

CerpPASS Technology Corporation Test Laboratory

NVLAP LAB Code:	200954-0
TAF LAB Code:	1439

CerpPASS Technology(SuZhou) Co., Ltd.

NVLAP LAB Code:	200814-0
CNAS LAB Code:	L5515



Contents

1. Summary of Test Procedure and Test Results	6
2. Immunity Testing Performance Criteria Definition	7
3. Test Configuration of Equipment under Test	8
3.1. Feature of Equipment under Test.....	8
3.2. Test Manner	9
3.3. Description of Support Unit	11
3.4. General Information of Test.....	12
3.5. Measurement Uncertainty	13
4. Test of Conducted Emission	15
4.1. Test Limit	15
4.2. Test Procedures	18
4.3. Typical Test Setup	18
4.4. Measurement Equipment.....	19
4.5. Test Result and Data.....	20
4.6. Test Photographs	37
5. Test of Radiated Emission	38
5.1. Test Limit.....	38
5.2. Test Procedures	41
5.3. Typical Test Setup	41
5.4. Measurement Equipment.....	42
5.5. Test Result and Data (30MHz ~ 1GHz).....	43
5.6. Test Result and Data (1GHz~6GHz).....	59
5.7. Test Photographs (30MHz~1GHz)	75
5.8. Test Photographs (1GHz~6GHz)	76
6. Harmonics Test	77
6.1. Limits of Harmonics Current Measurement	77
6.2. Measurement Equipment.....	78
6.3. Test Result and Data.....	79
6.4. Test Photographs	81
7. Voltage Fluctuations Test	82
7.1. Test Procedure	82
7.2. Measurement Equipment.....	82
7.3. Test Result and Data.....	83
7.4. Test Photographs	85
8. Electrostatic Discharge Immunity Test	86
8.1. Test Procedure	86
8.2. Test Setup for Tests Performed in Laboratory.....	87
8.3. Test Severity Levels	88
8.4. Measurement Equipment.....	88
8.5. Test Result and Data.....	89
8.6. Test Photographs	90
9. Radio Frequency electromagnetic field immunity test	91



- 9.1. Test Procedure 91
- 9.2. Test Severity Levels 91
- 9.3. TEST SETUP 92
- 9.4. Measurement Equipment 93
- 9.5. Test Result and Data 94
- 9.6. Test Photographs 95
- 10. Electrical Fast Transient/ Burst Immunity Test 96**
 - 10.1. Test Procedure 96
 - 10.2. Test Severity Levels 96
 - 10.3. TEST SETUP 97
 - 10.4. Measurement Equipment 97
 - 10.5. Test Result and Data 98
 - 10.6. Test Photographs 99
- 11. Surge Immunity Test 100**
 - 11.1. Test Procedure 100
 - 11.2. Test Severity Level 100
 - 11.3. TEST SETUP 101
 - 11.4. Measurement Equipment 101
 - 11.5. Test Result and Data 102
 - 11.6. Test Photographs 103
- 12. Conduction Disturbances induced by Radio-Frequency Fields 104**
 - 12.1. Test Procedure 104
 - 12.2. Test Severity Levels 104
 - 12.3. TEST SETUP 105
 - 12.4. Measurement Equipment 105
 - 12.5. Test Result and Data 106
 - 12.6. Test Photographs 107
- 13. Power Frequency Magnetic Field Immunity Test 108**
 - 13.1. Test Setup 108
 - 13.2. Test Severity Levels 108
 - 13.3. Measurement Equipment 108
 - 13.4. Test Result and Data 109
 - 13.5. Test Photographs 110
- 14. Voltage Dips and Voltage Interruptions Immunity Test Setup 111**
 - 14.1. Test Conditions 111
 - 14.2. TEST SETUP 111
 - 14.3. Measurement Equipment 111
 - 14.4. Test Result and Data 112
 - 14.5. Test Photographs 113
- 15. Photographs of EUT 114**



1. Summary of Test Procedure and Test Results

EMISSION[EN55032: 2012+AC 2013]			
Standard	Item	Result	Remarks
EN55032: 2012+AC 2013 AS/NZS CISPR 32 : 2013 CISPR 32 : 2015	Conducted (Power Port)	PASS	Meets Class B Limit Minimum passing margin(AV) is -4.18 dB at 0.1900 MHz
	Conducted (Telecom port)	N/A	N/A
	Radiated	PASS	Meets Class B Limit Minimum passing margin(Peak) is -4.76 dB at 189.0800 MHz
EN 61000-3-2: 2014	Harmonic current emissions	PASS	Meet Class D Limit
EN61000-3-3:2013	Voltage fluctuations & flicker	PASS	Meets the requirements

IMMUNITY [EN 55024: 2010]			
Standard	Item	Result	Remarks
IEC 61000-4-2: 2008	ESD	PASS	Meets the requirements of Performance Criterion A
IEC 61000-4-3: 2006+A1:2007+A2:2010	RS	PASS	Meets the requirements of Performance Criterion A
IEC 61000-4-4: 2012	EFT	PASS	Meets the requirements of Performance Criterion A
IEC 61000-4-5:2014	Surge	PASS	Meets the requirements of Performance Criterion A
IEC 61000-4-6:2013	CS	PASS	Meets the requirements of Performance Criterion A
IEC 61000-4-8:2009	PFMF	PASS	Meets the requirements of Performance Criterion A
IEC 61000-4-11:2004	Voltage dips & voltage variations	PASS	Meets the requirements of Voltage Dips: 1) >95% reduction Performance Criterion B 2) 30% reduction Performance Criterion B Voltage Interruptions: 1) >95% reduction Performance Criterion C



2. Immunity Testing Performance Criteria Definition

Criteria A:	The apparatus shall continue to operate as intended without operator intervention. No degradation of performance or loss of function is allowed below a performance level specified by the manufacturer, when the apparatus is used as intended. The performance level may be replaced by a permissible loss of performance. If the manufacturer does not specify the minimum performance level or the permissible performance loss, then either of these may be derived from the product description and documentation, and by what the user may reasonably expect from the equipment if used as intended.
Criteria B:	After test, the apparatus shall continue to operate as intended without operator intervention. No degradation of performance or loss of function is allowed, after the application of the phenomenon below a performance level specified by the manufacturer, when the apparatus is used as intended. The performance level may be replaced by a permissible loss of performance. During the test, degradation of performance is however allowed. However, no change of operating state if stored data is allowed to persist after the test. If the manufacturer does not specify the minimum performance level or the permissible performance loss, then either of these may be derived from the product description and documentation, and by what the user may reasonably expect from the equipment if used as intended.
Criteria C:	Temporary loss of function is allowed, provided the functions is self-recoverable or can be restored by the operation of controls by the user in accordance with the manufacturer instructions. Functions, and/or information stored in non-volatile memory, or protected by a battery backup, shall not be lost.



3. Test Configuration of Equipment under Test

3.1. Feature of Equipment under Test

Product Name:	LCD Monitor
Model Name:	270LM00043, **2790**** (The “*” could be any alphanumeric character including blank for marketing differentiation.)
Housing material:	Plastic case
EUT Highest Frequency:	241MHz
EUT Power Rating:	Input:100-240V, 50-60Hz 3Pin Power Port
AC Power Cord Type:	Non-shielded, 1.2m&1.5m&1.8m

Note: Please refer to user manual.

I/O PORT:

I/O PORT TYPE	Quantity
1). HDMI Port	2
2). Display Port	1
3). VGA Port	1
4). Audio Port	2
5). USB Port	5
6). Power Port	1



3.2. Test Manner

Test Manner

- a. During testing, the interface cables and equipment positions were varied according to Europe Standard.
- a. Running "H" pattern and Colour bars.
- c During the test, connect the PC, USB Keyboard, USB Mouse, Earphone, DVD, HDD and EUT, make the EUT at the test mode.
- d Adjust the EUT, then test.

The pre-test for CE/RE modes

Test Mode 1	Full system (Display mode 2560*1440@60Hz) Signal from PC for Horizontal (230V/50Hz)
Test Mode 2	Full system (Display mode 1280*1024@75Hz) Signal from PC for Horizontal (230V/50Hz)
Test Mode 3	Full system (Display mode 640*480@60Hz) Signal from PC for Horizontal (230V/50Hz)
Test Mode 4	Full system (Display mode 2560*1440@60Hz) Signal from PC for Vertical (230V/50Hz)
Test Mode 5	Full system (VGA mode 1920*1080@60Hz) Signal from PC for Horizontal (230V/50Hz)
Test Mode 6	Full system (VGA mode 1280*1024@75Hz) Signal from PC for Horizontal (230V/50Hz)
Test Mode 7	Full system (VGA mode 640*480@60Hz) Signal from PC for Horizontal (230V/50Hz)
Test Mode 8	Full system (VGA mode 1920*1080@60Hz) Signal from PC for Vertical (230V/50Hz)
Test Mode 9	Full system (HDMI 1 mode 2560*1440@60Hz) Signal from PC for Horizontal (230V/50Hz)
Test Mode 10	Full system (HDMI 1 mode 1280*1024@75Hz) Signal from PC for Horizontal (230V/50Hz)
Test Mode 11	Full system (HDMI 1 mode 640*480@60Hz) Signal from PC for Horizontal (230V/50Hz)
Test Mode 12	Full system (HDMI 1 mode 2560*1440@60Hz) Signal from PC for Vertical (230V/50Hz)
Test Mode 13	Full system (HDMI 1 mode 1080P) Signal from DVD for Horizontal (230V/50Hz)
Test Mode 14	Full system (HDMI 2 mode 2560*1440@60Hz) Signal from PC for Horizontal (230V/50Hz)
Test Mode 15	Full system (HDMI 2 mode 1280*1024@75Hz) Signal from PC for Horizontal (230V/50Hz)
Test Mode 16	Full system (HDMI 2 mode 640*480@60Hz) Signal from PC for Horizontal (230V/50Hz)



- Test Mode 17 Full system (HDMI 2 mode 2560*1440@60Hz) Signal from PC for Vertical (230V/50Hz)
 - Test Mode 18 Full system (HDMI 2 mode 1080P) Signal from DVD for Horizontal (230V/50Hz)
 - Test Mode 19 Full system (Display mode 2560*1440@60Hz) Signal from PC for Horizontal (110V/60Hz)
 - Test Mode 20 Full system (VGA mode 1920*1080@60Hz) Signal from PC for Horizontal (110V/60Hz)
 - Test Mode 21 Full system (HDMI 1 mode 2560*1440@60Hz) Signal from PC for Horizontal (110V/60Hz)
 - Test Mode 22 Full system (HDMI 2 mode 2560*1440@60Hz) Signal from PC for Horizontal (110V/60Hz)
- “Test mode 1,5,9,14,19,20,21,22” were reported as final data.

The pre-test for H&F/EMS modes

- Test Mode 1 Full system (Display mode 2560*1440@60Hz) Signal from PC for Horizontal
 - Test Mode 2 Full system (Display mode 1280*1024@75Hz) Signal from PC for Horizontal
 - Test Mode 3 Full system (Display mode 640*480@60Hz) Signal from PC for Horizontal
 - Test Mode 4 Full system (Display mode 2560*1440@60Hz) Signal from PC for Vertical
 - Test Mode 5 Full system (VGA mode 1920*1080@60Hz) Signal from PC for Horizontal
 - Test Mode 6 Full system (VGA mode 1280*1024@75Hz) Signal from PC for Horizontal
 - Test Mode 7 Full system (VGA mode 640*480@60Hz) Signal from PC for Horizontal
 - Test Mode 8 Full system (VGA mode 1920*1080@60Hz) Signal from PC for Vertical
 - Test Mode 9 Full system (HDMI 1 mode 2560*1440@60Hz) Signal from PC for Horizontal
 - Test Mode 10 Full system (HDMI 1 mode 1280*1024@75Hz) Signal from PC for Horizontal
 - Test Mode 11 Full system (HDMI 1 mode 640*480@60Hz) Signal from PC for Horizontal
 - Test Mode 12 Full system (HDMI 1 mode 2560*1440@60Hz) Signal from PC for Vertical
 - Test Mode 13 Full system (HDMI 1 mode 1080P) Signal from DVD for Horizontal
 - Test Mode 14 Full system (HDMI 2 mode 2560*1440@60Hz) Signal from PC for Horizontal
 - Test Mode 15 Full system (HDMI 2 mode 1280*1024@75Hz) Signal from PC for Horizontal
 - Test Mode 16 Full system (HDMI 2 mode 640*480@60Hz) Signal from PC for Horizontal
 - Test Mode 17 Full system (HDMI 2 mode 2560*1440@60Hz) Signal from PC for Vertical
 - Test Mode 18 Full system (HDMI 2 mode 1080P) Signal from DVD for Horizontal
- “Test mode 1,5,9,14” were reported as final data.

The maximum operating frequency is above 108MHz, the test frequency range is from 1GHz to 6GHz.



3.3. Description of Support Unit

No.	Device	Manufacturer	Model No.	Description
1	PC	HP	HP Compaq Elite 8200 MTPC	Non-Shielded ,1.8m(R3 3001)
2	USB Keyboard	DELL	SK-8115	T3A002
3	USB Mouse	DELL	G0K02XYK	R41108
4	Earphone	EDIFIER	N/A	N/A
5	DVD	PIONEER	DV-600AV-S	N/A
6	HDD	WD	WDBPCK5000ABK-01	N/A
7	HDD	WD	WDBPCK5000ABK-02	N/A
8	HDD	WD	WDBPCK5000ABK-03	N/A
9	HDD	WD	WDBPCK5000ABK-04	N/A

No.	Cable	Quantity	Description
A	USB Cable	1	Shielded, 1.8m, with one ferrite core bonded
B	USB Cable	1	Shielded, 1.2m
C	Audio Cable	1	Non-Shielded, 1.8m
D	HDMI Cable	1	Shielded, 1.2m&1.5m&1.8m
E	USB Cable	1	Shielded, 1.8m
F	VGA Cable	1	Shielded, 1.2m&1.5m&1.8m, with two ferrites core bonded
G	DISPLAY Cable	1	Shielded, 1.2m&1.5m&1.8m
H	Audio Cable	1	Shielded, 1.2m&1.5m&1.8m
I	HDMI Cable	1	Shielded, 1.2m&1.5m&1.8m
J	USB Cable	1	Shielded, 0.6m
K	USB Cable	1	Shielded, 0.6m
L	USB Cable	1	Shielded, 0.6m
M	USB Cable	1	Shielded, 0.6m



3.4. General Information of Test

<input type="checkbox"/>	Test Site	<p>CerpPASS Technology Corporation Test Laboratory Address: No.10, Ln. 2, Lianfu St., Luzhu Dist., Taoyuan City 33848, Taiwan (R.O.C.) Tel:+886-3-3226-888 Fax:+886-3-3226-881 Address: No.68-1, Shihbachongsi, Shihding Township, New Taipei City 223, Taiwan, R.O.C. Tel: +886-2-2663-8582</p>
	FCC	TW1079, TW1061,390316, 228391, 641184
	IC	4934B-1, 4934E-1, 4934E-2
	VCCI	T-2205 for Telecommunication Test C-4663 for Conducted emission test R-3428, R-4218 for Radiated emission test G-812, G-813 for radiated disturbance above 1GHz
<input checked="" type="checkbox"/>	Test Site	<p>CerpPASS Technology (Suzhou) Co.,Ltd Address: No.66,Tangzhuang Road, Suzhou Industrial Park, Jiangsu 215006, China Tel: +86-512-6917-5888 Fax: +86-512-6917-5666</p>
	FCC	331395
	IC	7290A-1, 7290A-2
	VCCI	T-1945 for Telecommunication Test C-2919 for Conducted emission test R-2670 for Radiated emission test G-227 for radiated disturbance above 1GHz
Frequency Range Investigated:		Conducted: from 150kHz to 30 MHz Radiation: from 30 MHz to 6000MHz
Test Distance :		The test distance of radiated emission below 1GHz from antenna to EUT is 10 M. The test distance of radiated emission above 1GHz from antenna to EUT is 3 M.



3.5. Measurement Uncertainty

Where relevant, the following measurement uncertainty levels have been estimated for tests performed on the EUT as specified in CISPR 16-4-2:

Measurement	Frequency	Uncertainty
Conducted emissions(LINE)	9KHz-30MHz	+/- 0.7738 dB
Conducted emissions(NEUTRAL)	9KHz-30MHz	+/- 0.7886 dB

Measurement	Polarity	Frequency	Uncertainty
Radiated emissions (below 1GHz)	H	30MHz ~ 200MHz	+/- 3.8909dB
		200MHz ~1000MHz	+/- 3.6555dB
	V	30MHz ~ 200MHz	+/- 3.8948dB
		200MHz ~1000MHz	+/- 3.6538dB
Radiated emissions (above 1GHz)	H	1000MHz ~18000MHz	+/- 3.8948 dB
		18000MHz ~40000MHz	+/-3.8844dB
	V	1000MHz ~18000MHz	+/- 3.8906dB
		18000MHz ~40000MHz	+/- 3.8744dB

Measurement	Uncertainty
ESD—Rise time tr	10%
ESD—Peak current Ip	6%
ESD—Current at 30 ns	6%
ESD—Current at 60 ns	6%
ESD- Charging voltage	1%
RS above 1GHz	±2.37dB
RS under 1GHz	±3.83dB
EFT—Rise time tr	4%
EFT—Peak current Ip	4%
EFT—Current	4%
Surge—Rise time tr	4%
Surge—Peak current Ip	4%



Surge—Current	4%
CS-CND	±0.80dB
CS-Clamp	±1.06dB

This uncertainty represents an expanded uncertainty expressed at approximately the 95% confidence level using a coverage factor of k=2.

Consistent with industry standard (e.g. CISPR 22: 2008, clause 11, Measurement Uncertainty) determining compliance with the limits shall be base on the results of the compliance measurement. Consequently the measure emissions being less than the maximum allowed emission result in this be a compliant test or passing test.



4. Test of Conducted Emission

4.1. Test Limit

Conducted Emissions were measured from 150 kHz to 30 MHz with a bandwidth of 9 kHz and return leads of the EUT according to the methods defined in European Standard EN 55032.

Table A.8 – Requirements for conducted emissions from the AC mains power ports of Class A equipment

Applicable to				
1. AC mains power ports (3.1.1)				
Table clause	Frequency range MHz	Coupling device (see Table A.7)	Detector type / bandwidth	Class A limits dB(μ V)
A8.1	0,15 – 0,5	AMN	Quasi Peak / 9 kHz	79
	0,5 – 30			73
A8.2	0,15 – 0,5	AMN	Average / 9 kHz	66
	0,5 – 30			60

NOTE Apply A8.1 and A8.2 across the entire frequency range.

Table A.9 – Requirements for conducted emissions from the AC mains power ports of Class B equipment

Applicable to				
1. AC mains power ports (3.1.1)				
Table clause	Frequency range MHz	Coupling device (see Table A.7)	Detector type / bandwidth	Class B limits dB(μ V)
A9.1	0,15 – 0,5	AMN	Quasi Peak / 9 kHz	66 – 56
	0,5 – 5			56
	5 – 30			60
A9.2	0,15 – 0,5	AMN	Average / 9 kHz	56 – 46
	0,5 – 5			46
	5 – 30			50

NOTE Apply A9.1 and A9.2 across the entire frequency range.



Table A.10 – Requirements for asymmetric mode conducted emissions from Class A equipment

Applicable to					
1. wired network ports (3.1.30) 2. optical fibre ports (3.1.24) with metallic shield or tension members 3. antenna ports (3.1.3)					
Table clause	Frequency range MHz	Coupling device (see Table A.7)	Detector type / bandwidth	Class A voltage limits dB(μV)	Class A current limits dB(μA)
A10.1	0,15 – 0,5	AAN	Quasi Peak / 9 kHz	97 – 87	n/a
	0,5 – 30			87	
	0,15 – 0,5	AAN	Average / 9 kHz	84 – 74	
	0,5 – 30			74	
A10.2	0,15 – 0,5	CVP and current probe	Quasi Peak / 9 kHz	97 – 87	53 – 43
	0,5 – 30			87	43
	0,15 – 0,5	CVP and current probe	Average / 9 kHz	84 – 74	40 – 30
	0,5 – 30			74	30
A10.3	0,15 – 0,5	Current Probe	Quasi Peak / 9 kHz	n/a	53 – 43
	0,5 – 30				43
	0,15 – 0,5	Current Probe	Average / 9 kHz		40 – 30
	0,5 – 30				30
NOTE 1 The choice of coupling device and measurement procedure is defined in Annex C.					
NOTE 2 AC mains power ports shall meet the limits given in Table A.8.					
NOTE 3 The test shall cover the entire frequency range.					
NOTE 4 The application of the voltage and/or current limits is dependent on the measurement procedure used. Refer to Table C.1 for applicability.					
NOTE 5 Testing is required at only one EUT supply voltage and frequency.					
NOTE 6 Applicable to ports listed above and intended to connect to cables longer than 3 m.					



Table A.11 – Requirements for asymmetric mode conducted emissions from Class B equipment

Applicable to					
1. wired network ports (3.1.30) 2. optical fibre ports (3.1.24) with metallic shield or tension members 3. broadcast receiver tuner ports (3.1.8) 4. antenna ports (3.1.3)					
Table clause	Frequency range MHz	Coupling device (see Table A.7)	Detector type / bandwidth	Class B voltage limits dB(μV)	Class B current limits dB(μA)
A11.1	0,15 – 0,5	AAN	Quasi Peak / 9 kHz	84 – 74	n/a
	0,5 – 30			74	
	0,15 – 0,5	AAN	Average / 9 kHz	74 – 64	
	0,5 – 30			64	
A11.2	0,15 – 0,5	CVP and current probe	Quasi Peak / 9 kHz	84 – 74	40 – 30
	0,5 – 30			74	30
	0,15 – 0,5	CVP and current probe	Average / 9 kHz	74 – 64	30 – 20
	0,5 – 30			64	20
A11.3	0,15 – 0,5	Current Probe	Quasi Peak / 9 kHz	n/a	40 – 30
	0,5 – 30				30
	0,15 – 0,5	Current Probe	Average / 9 kHz		30 – 20
	0,5 – 30				20
NOTE 1 The choice of coupling device and measurement procedure is defined in Annex C. NOTE 2 Screened ports including TV broadcast receiver tuner ports are tested with a common-mode impedance of 150 Ω. This is typically accomplished with the screen terminated by 150 Ω to earth. NOTE 3 AC mains power ports shall meet the limits given in Table A.9. NOTE 4 The test shall cover the entire frequency range. NOTE 5 The application of the voltage and/or current limits is dependent on the measurement procedure used. Refer to Table C.1 for applicability. NOTE 6 Testing is required at only one EUT supply voltage and frequency. NOTE 7 Applicable to ports listed above and intended to connect to cables longer than 3 m.					



4.4. Measurement Equipment

Instrument/Ancillary	Manufacturer	Model No.	Serial No.	Calibration Date	Valid Date.
Test Receiver	R&S	ESCI	100565	2016.07.07	2017.07.06
AMN	R&S	ESH2-Z5	100182	2016.08.31	2017.08.30
Two-Line V-Network	R&S	ENV216	100325	/	/
ISN	FCC	FCC-TLISN-T2-02	20379	2017.03.22	2018.03.21
ISN	FCC	FCC-TLISN-T4-02	20380	2016.06.24	2017.06.23
ISN	FCC	FCC-TLISN-T8-02	20381	2016.11.29	2017.11.28
ISN	TESEQ	ISN ST08	30175	2016.08.31	2017.08.30
LISN	FCC	FCC-LISN-50-200-2-02	112087	2016.08.31	2017.08.30
Current Probe	R&S	EZ-17	100303	2017.03.22	2018.03.21
Passive Voltage Probe	R&S	ESH2-Z3	100026	2017.03.22	2018.03.21
Pulse Limiter	R&S	ESH3-Z2	100529	2017.03.22	2018.03.21
Temperature/ Humidity Meter	Zhicheng	ZC1-11	CEP-TH-004	2017.03.28	2018.03.27
EZ-EMC	Fala	Ver CT3A1	N/A	N/A	N/A



4.5. Test Result and Data

4.5.1 Conducted Emission for Power Port Test Data

Test Mode :	Mode 1: Full system (Display mode 2560*1440@60Hz) Signal from PC for Horizontal (230V/50Hz)		
AC Power :	AC 230V/50Hz	Phase :	LINE
Equipment :	LCD Monitor	Model No :	270LM00043
Temperature :	25°C	Humidity :	52%
Pressure(mbar) :	1001	Date:	2017/05/16

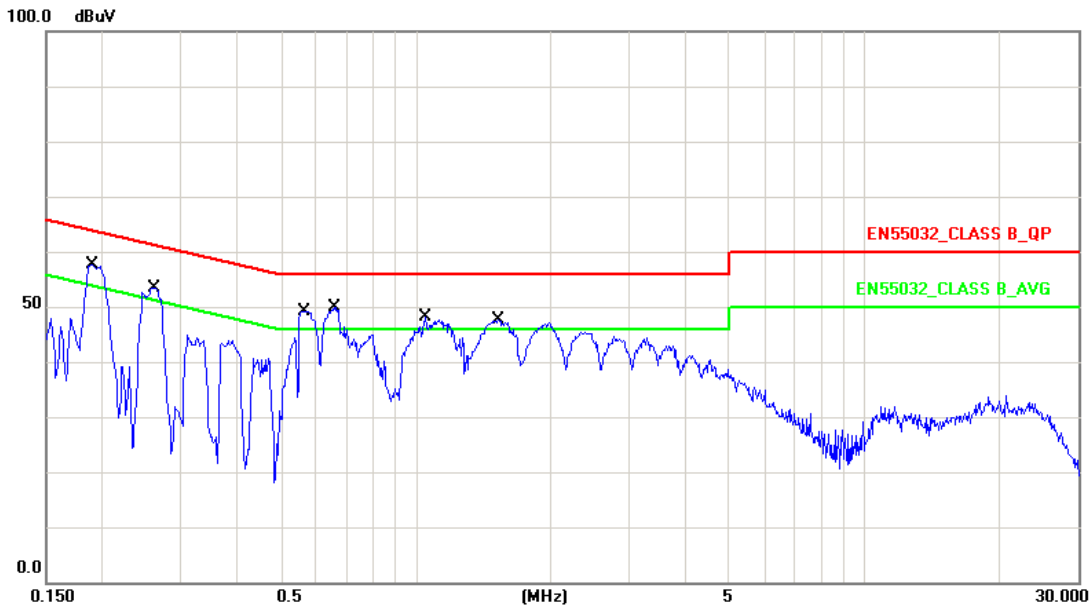

No.	Frequency (MHz)	Factor (dB)	Reading (dBuV)	Level (dBuV)	Limit (dBuV)	Margin (dB)	Detector
1	0.1900	10.12	44.97	55.09	64.03	-8.94	QP
2	0.1900	10.12	38.68	48.80	54.03	-5.23	AVG
3	0.2620	10.13	40.79	50.92	61.36	-10.44	QP
4	0.2620	10.13	33.85	43.98	51.36	-7.38	AVG
5	0.5660	10.16	37.88	48.04	56.00	-7.96	QP
6	0.5660	10.16	25.14	35.30	46.00	-10.70	AVG
7	0.6580	10.15	38.16	48.31	56.00	-7.69	QP
8	0.6580	10.15	24.94	35.09	46.00	-10.91	AVG
9	1.0540	10.16	34.49	44.65	56.00	-11.35	QP
10	1.0540	10.16	23.38	33.54	46.00	-12.46	AVG
11	1.5300	10.17	35.22	45.39	56.00	-10.61	QP
12	1.5300	10.17	22.11	32.28	46.00	-13.72	AVG

Note: Measurement Level = Reading Level + Correct Factor



Test Mode :	Mode 1: Full system (Display mode 2560*1440@60Hz) Signal from PC for Horizontal (230V/50Hz)		
AC Power :	AC 230V/50Hz	Phase :	NEUTRAL
Equipment :	LCD Monitor	Model No :	270LM00043
Temperature :	25°C	Humidity :	52%
Pressure(mbar) :	1001	Date:	2017/05/16

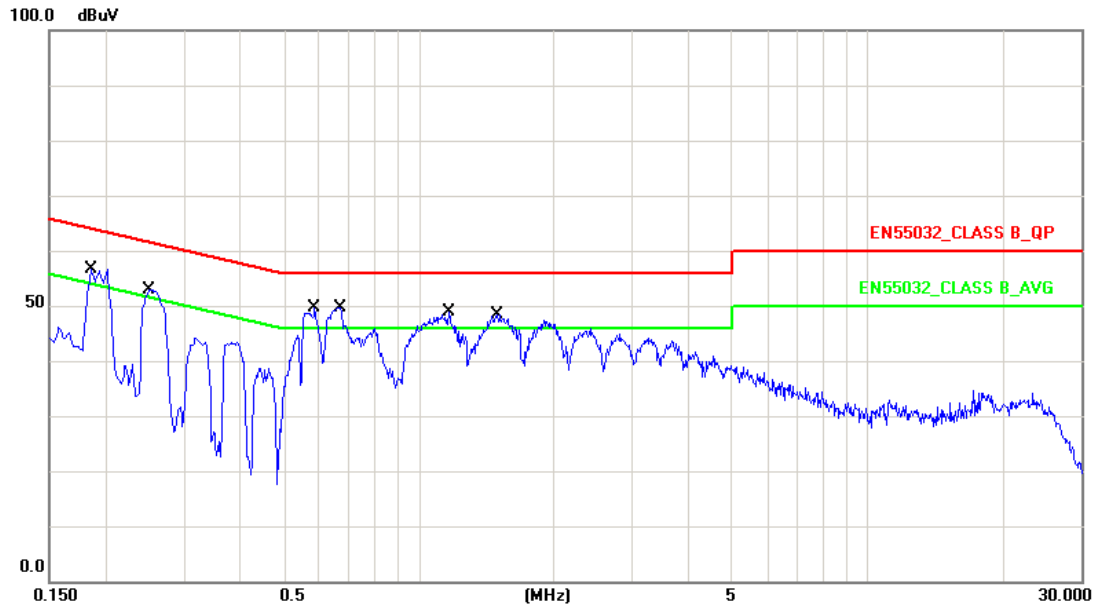

No.	Frequency (MHz)	Factor (dB)	Reading (dBuV)	Level (dBuV)	Limit (dBuV)	Margin (dB)	Detector
1	0.1860	10.13	43.69	53.82	64.21	-10.39	QP
2	0.1860	10.13	33.76	43.89	54.21	-10.32	AVG
3	0.2521	10.13	40.34	50.47	61.68	-11.21	QP
4	0.2521	10.13	32.92	43.05	51.68	-8.63	AVG
5	0.5860	10.15	36.27	46.42	56.00	-9.58	QP
6	0.5860	10.15	25.54	35.69	46.00	-10.31	AVG
7	0.6700	10.16	37.83	47.99	56.00	-8.01	QP
8	0.6700	10.16	21.34	31.50	46.00	-14.50	AVG
9	1.1660	10.18	34.65	44.83	56.00	-11.17	QP
10	1.1660	10.18	21.05	31.23	46.00	-14.77	AVG
11	1.4980	10.18	35.72	45.90	56.00	-10.10	QP
12	1.4980	10.18	22.88	33.06	46.00	-12.94	AVG

Note: Measurement Level = Reading Level + Correct Factor



Test Mode :	Mode 5: Full system (VGA mode 1920*1080@60Hz) Signal from PC for Horizontal (230V/50Hz)		
AC Power :	AC 230V/50Hz	Phase :	LINE
Equipment :	LCD Monitor	Model No :	270LM00043
Temperature :	25°C	Humidity :	52%
Pressure(mbar) :	1001	Date:	2017/05/16

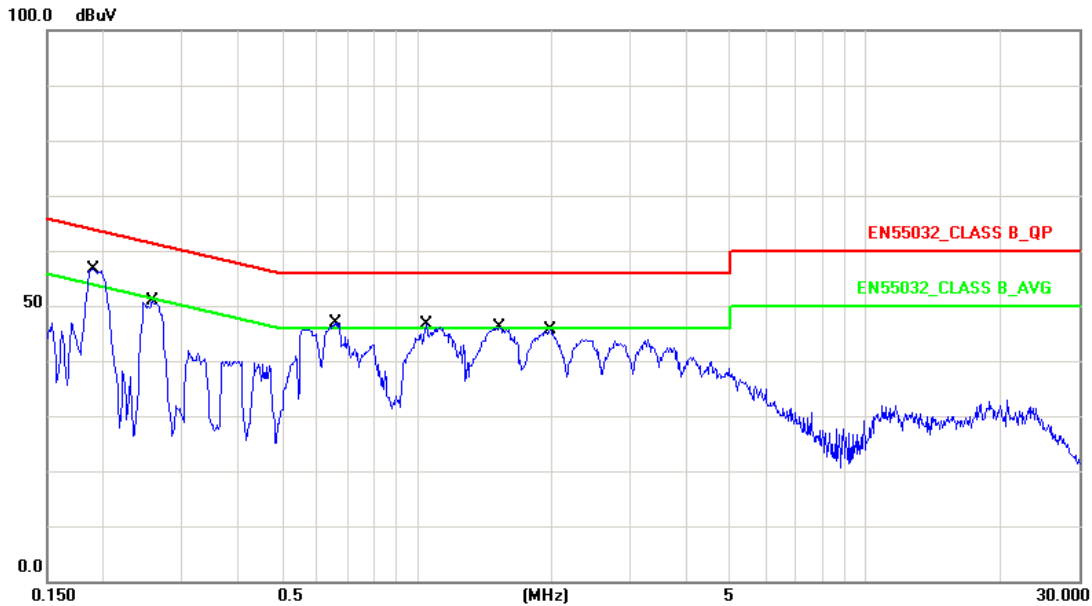

No.	Frequency (MHz)	Factor (dB)	Reading (dBuV)	Level (dBuV)	Limit (dBuV)	Margin (dB)	Detector
1	0.1900	10.12	45.27	55.39	64.03	-8.64	QP
2	0.1900	10.12	39.05	49.17	54.03	-4.86	AVG
3	0.2580	10.13	41.42	51.55	61.49	-9.94	QP
4	0.2580	10.13	35.09	45.22	51.49	-6.27	AVG
5	0.6580	10.15	38.45	48.60	56.00	-7.40	QP
6	0.6580	10.15	25.27	35.42	46.00	-10.58	AVG
7	1.0540	10.16	34.81	44.97	56.00	-11.03	QP
8	1.0540	10.16	23.62	33.78	46.00	-12.22	AVG
9	1.5300	10.17	35.47	45.64	56.00	-10.36	QP
10	1.5300	10.17	22.38	32.55	46.00	-13.45	AVG
11	1.9859	10.17	34.33	44.50	56.00	-11.50	QP
12	1.9859	10.17	22.96	33.13	46.00	-12.87	AVG

Note: Measurement Level = Reading Level + Correct Factor



Test Mode :	Mode 5: Full system (VGA mode 1920*1080@60Hz) Signal from PC for Horizontal (230V/50Hz)		
AC Power :	AC 230V/50Hz	Phase :	NEUTRAL
Equipment :	LCD Monitor	Model No :	270LM00043
Temperature :	25°C	Humidity :	52%
Pressure(mbar) :	1001	Date:	2017/05/16

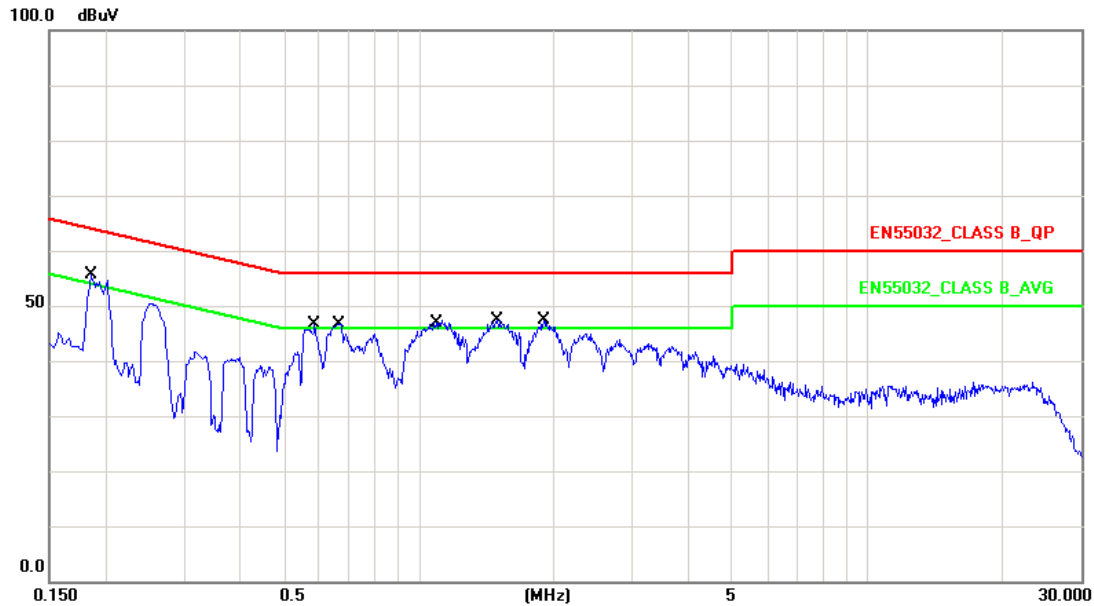

No.	Frequency (MHz)	Factor (dB)	Reading (dBuV)	Level (dBuV)	Limit (dBuV)	Margin (dB)	Detector
1	0.1859	10.13	45.05	55.18	64.21	-9.03	QP
2	0.1859	10.13	35.07	45.20	54.21	-9.01	AVG
3	0.5860	10.15	37.23	47.38	56.00	-8.62	QP
4	0.5860	10.15	26.09	36.24	46.00	-9.76	AVG
5	0.6580	10.16	38.48	48.64	56.00	-7.36	QP
6	0.6580	10.16	25.31	35.47	46.00	-10.53	AVG
7	1.0859	10.18	34.79	44.97	56.00	-11.03	QP
8	1.0859	10.18	20.47	30.65	46.00	-15.35	AVG
9	1.4979	10.18	35.69	45.87	56.00	-10.13	QP
10	1.4979	10.18	22.78	32.96	46.00	-13.04	AVG
11	1.9020	10.18	34.28	44.46	56.00	-11.54	QP
12	1.9020	10.18	21.64	31.82	46.00	-14.18	AVG

Note: Measurement Level = Reading Level + Correct Factor



Test Mode :	Mode 9: Full system (HDMI 1 mode 2560*1440@60Hz) Signal from PC for Horizontal (230V/50Hz)		
AC Power :	AC 230V/50Hz	Phase :	LINE
Equipment :	LCD Monitor	Model No :	270LM00043
Temperature :	25°C	Humidity :	52%
Pressure(mbar) :	1001	Date:	2017/05/16

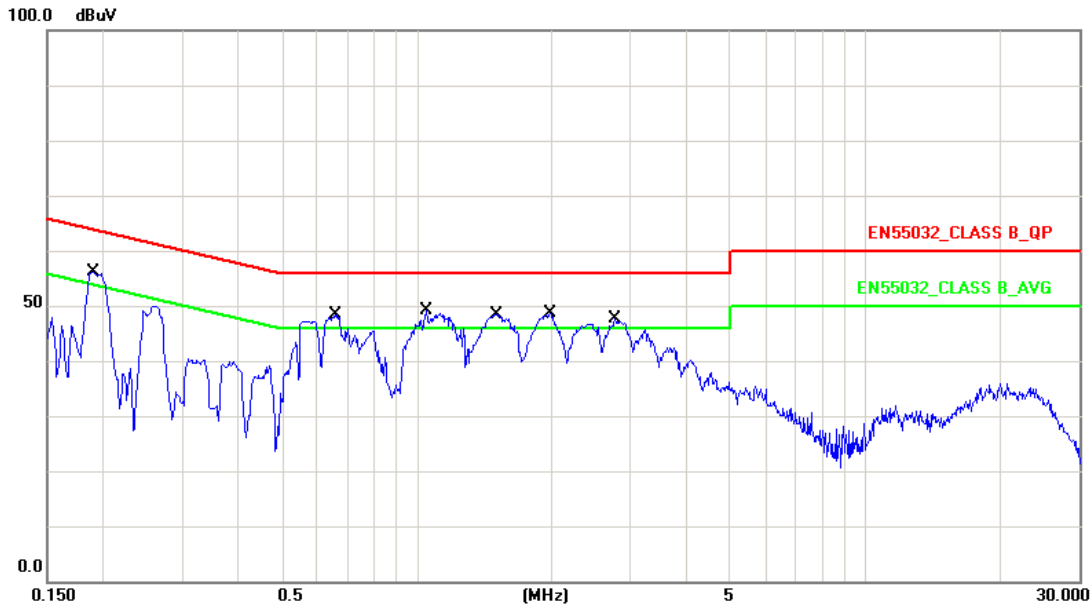

No.	Frequency (MHz)	Factor (dB)	Reading (dBuV)	Level (dBuV)	Limit (dBuV)	Margin (dB)	Detector
1	0.1900	10.12	45.56	55.68	64.03	-8.35	QP
2	0.1900	10.12	39.25	49.37	54.03	-4.66	AVG
3	0.6580	10.15	38.77	48.92	56.00	-7.08	QP
4	0.6580	10.15	25.54	35.69	46.00	-10.31	AVG
5	1.0540	10.16	34.95	45.11	56.00	-10.89	QP
6	1.0540	10.16	23.75	33.91	46.00	-12.09	AVG
7	1.5100	10.17	35.88	46.05	56.00	-9.95	QP
8	1.5100	10.17	22.96	33.13	46.00	-12.87	AVG
9	1.9858	10.17	34.54	44.71	56.00	-11.29	QP
10	1.9858	10.17	22.99	33.16	46.00	-12.84	AVG
11	2.7780	10.18	31.59	41.77	56.00	-14.23	QP
12	2.7780	10.18	21.10	31.28	46.00	-14.72	AVG

Note: Measurement Level = Reading Level + Correct Factor



Test Mode :	Mode 9: Full system (HDMI 1 mode 2560*1440@60Hz) Signal from PC for Horizontal (230V/50Hz)		
AC Power :	AC 230V/50Hz	Phase :	NEUTRAL
Equipment :	LCD Monitor	Model No :	270LM00043
Temperature :	25°C	Humidity :	52%
Pressure(mbar) :	1001	Date:	2017/05/16

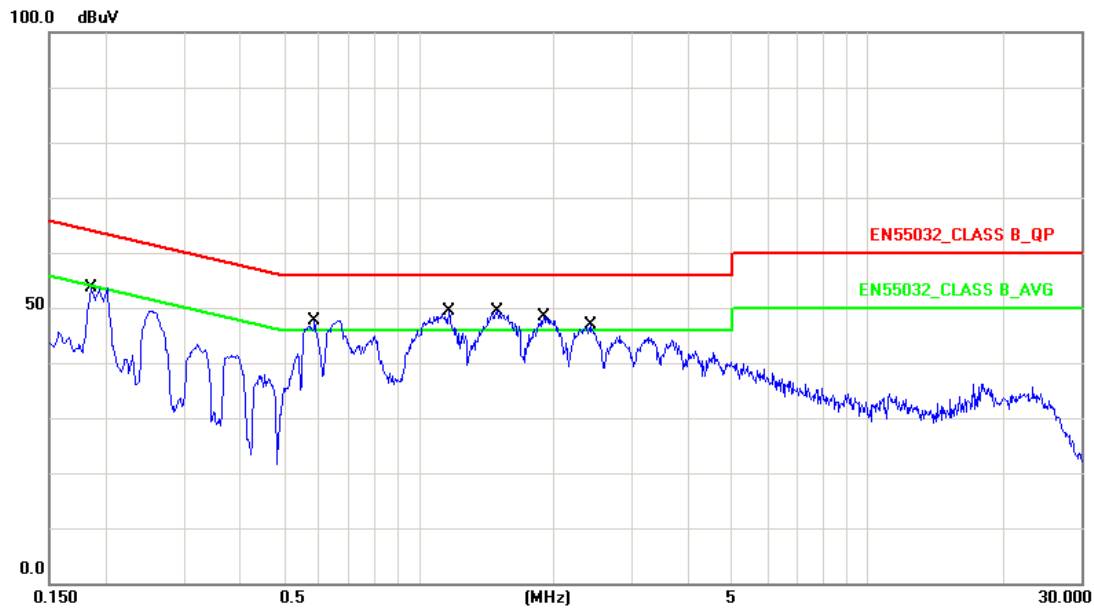

No.	Frequency (MHz)	Factor (dB)	Reading (dBuV)	Level (dBuV)	Limit (dBuV)	Margin (dB)	Detector
1	0.1859	10.13	45.15	55.28	64.21	-8.93	QP
2	0.1859	10.13	35.27	45.40	54.21	-8.81	AVG
3	0.5860	10.15	37.21	47.36	56.00	-8.64	QP
4	0.5860	10.15	26.08	36.23	46.00	-9.77	AVG
5	1.1660	10.18	34.57	44.75	56.00	-11.25	QP
6	1.1660	10.18	21.64	31.82	46.00	-14.18	AVG
7	1.4979	10.18	35.69	45.87	56.00	-10.13	QP
8	1.4979	10.18	22.89	33.07	46.00	-12.93	AVG
9	1.9020	10.18	34.35	44.53	56.00	-11.47	QP
10	1.9020	10.18	21.69	31.87	46.00	-14.13	AVG
11	2.4140	10.19	32.69	42.88	56.00	-13.12	QP
12	2.4140	10.19	22.37	32.56	46.00	-13.44	AVG

Note: Measurement Level = Reading Level + Correct Factor



Test Mode :	Mode 14: Full system (HDMI 2 mode 2560*1440@60Hz) Signal from PC for Horizontal (230V/50Hz)		
AC Power :	AC 230V/50Hz	Phase :	LINE
Equipment :	LCD Monitor	Model No :	270LM00043
Temperature :	25°C	Humidity :	52%
Pressure(mbar) :	1001	Date:	2017/05/16

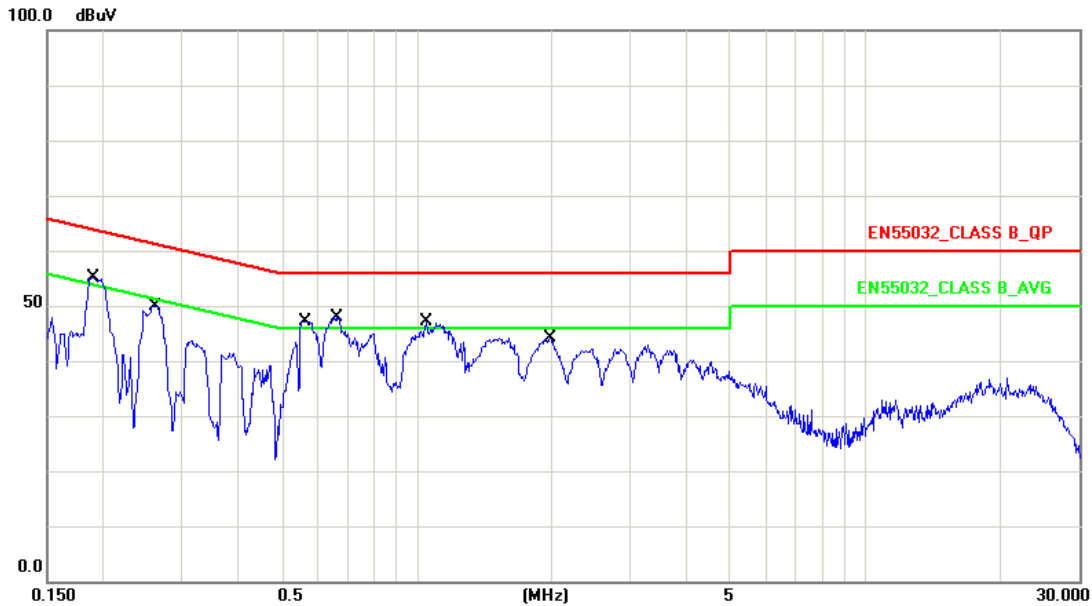

No.	Frequency (MHz)	Factor (dB)	Reading (dBuV)	Level (dBuV)	Limit (dBuV)	Margin (dB)	Detector
1	0.1900	10.12	45.59	55.71	64.03	-8.32	QP
2	0.1900	10.12	39.23	49.35	54.03	-4.68	AVG
3	0.2620	10.13	41.41	51.54	61.36	-9.82	QP
4	0.2620	10.13	34.59	44.72	51.36	-6.64	AVG
5	0.5660	10.16	38.34	48.50	56.00	-7.50	QP
6	0.5660	10.16	25.42	35.58	46.00	-10.42	AVG
7	0.6620	10.15	38.87	49.02	56.00	-6.98	QP
8	0.6620	10.15	25.23	35.38	46.00	-10.62	AVG
9	1.0540	10.16	35.08	45.24	56.00	-10.76	QP
10	1.0540	10.16	23.93	34.09	46.00	-11.91	AVG
11	1.9858	10.17	34.54	44.71	56.00	-11.29	QP
12	1.9858	10.17	23.01	33.18	46.00	-12.82	AVG

Note: Measurement Level = Reading Level + Correct Factor



Test Mode : Mode 14: Full system (HDMI 2 mode 2560*1440@60Hz) Signal from PC for Horizontal (230V/50Hz)

AC Power : AC 230V/50Hz Phase : NEUTRAL

Equipment : LCD Monitor Model No : 270LM00043

Temperature : 25°C Humidity : 52%

Pressure(mbar) : 1001 Date: 2017/05/16

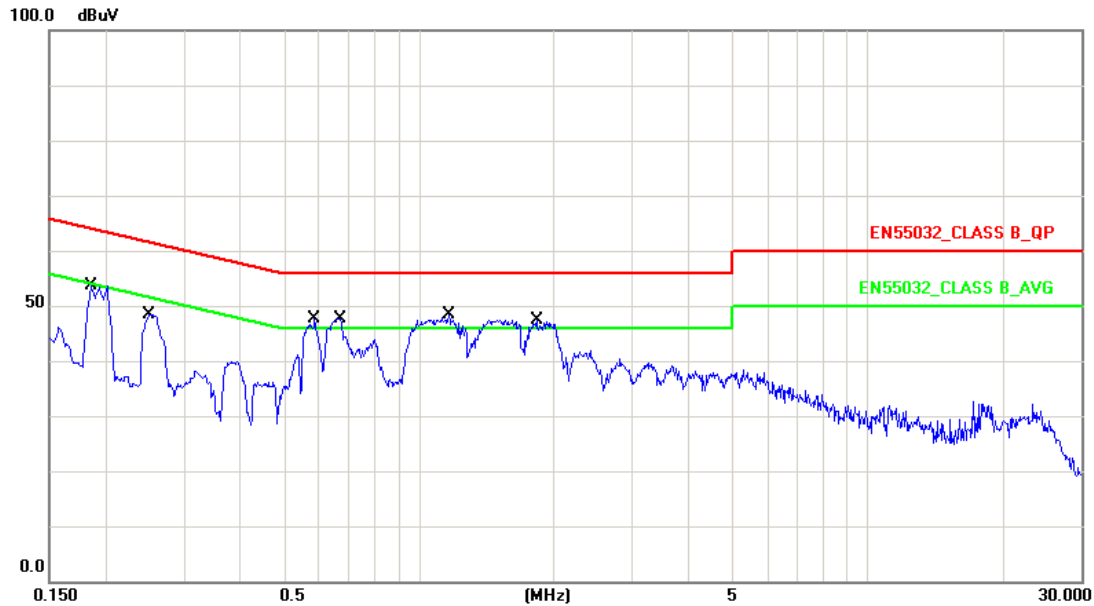

No.	Frequency (MHz)	Factor (dB)	Reading (dBuV)	Level (dBuV)	Limit (dBuV)	Margin (dB)	Detector
1	0.1859	10.13	45.29	55.42	64.21	-8.79	QP
2	0.1859	10.13	35.15	45.28	54.21	-8.93	AVG
3	0.2500	10.13	42.09	52.22	61.75	-9.53	QP
4	0.2500	10.13	33.23	43.36	51.75	-8.39	AVG
5	0.5860	10.15	37.12	47.27	56.00	-8.73	QP
6	0.5860	10.15	25.83	35.98	46.00	-10.02	AVG
7	0.6700	10.16	38.57	48.73	56.00	-7.27	QP
8	0.6700	10.16	22.72	32.88	46.00	-13.12	AVG
9	1.1660	10.18	34.60	44.78	56.00	-11.22	QP
10	1.1660	10.18	21.82	32.00	46.00	-14.00	AVG
11	1.8300	10.18	32.73	42.91	56.00	-13.09	QP
12	1.8300	10.18	19.19	29.37	46.00	-16.63	AVG

Note: Measurement Level = Reading Level + Correct Factor



Test Mode :	Mode 19: Full system (Display mode 2560*1440@60Hz) Signal from PC for Horizontal (110V/60Hz)		
AC Power :	AC 110V/60Hz	Phase :	LINE
Equipment :	LCD Monitor	Model No :	270LM00043
Temperature :	25°C	Humidity :	52%
Pressure(mbar) :	1001	Date:	2017/05/16

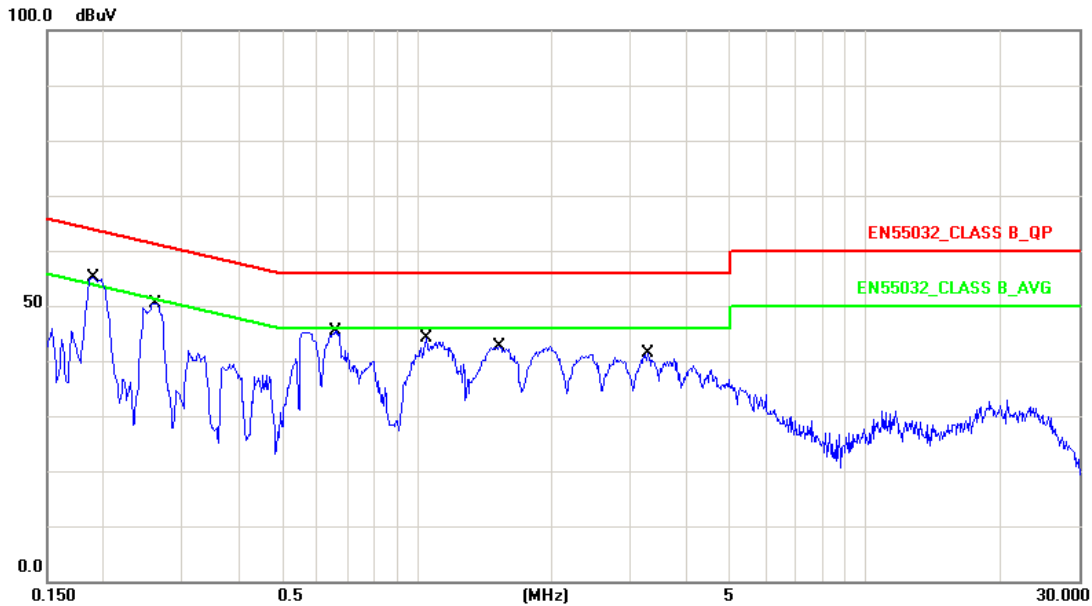

No.	Frequency (MHz)	Factor (dB)	Reading (dBuV)	Level (dBuV)	Limit (dBuV)	Margin (dB)	Detector
1	0.1900	10.12	45.74	55.86	64.03	-8.17	QP
2	0.1900	10.12	39.40	49.52	54.03	-4.51	AVG
3	0.2620	10.13	41.57	51.70	61.36	-9.66	QP
4	0.2620	10.13	34.79	44.92	51.36	-6.44	AVG
5	0.6580	10.15	38.97	49.12	56.00	-6.88	QP
6	0.6580	10.15	25.81	35.96	46.00	-10.04	AVG
7	1.0540	10.16	35.15	45.31	56.00	-10.69	QP
8	1.0540	10.16	23.99	34.15	46.00	-11.85	AVG
9	1.5300	10.17	35.87	46.04	56.00	-9.96	QP
10	1.5300	10.17	22.76	32.93	46.00	-13.07	AVG
11	3.2860	10.19	30.72	40.91	56.00	-15.09	QP
12	3.2860	10.19	22.48	32.67	46.00	-13.33	AVG

Note: Measurement Level = Reading Level + Correct Factor



Test Mode : Mode 19: Full system (Display mode 2560*1440@60Hz) Signal from PC for Horizontal (110V/60Hz)

AC Power : AC 110V/60Hz Phase : NEUTRAL

Equipment : LCD Monitor Model No : 270LM00043

Temperature : 25°C Humidity : 52%

Pressure(mbar) : 1001 Date: 2017/05/16

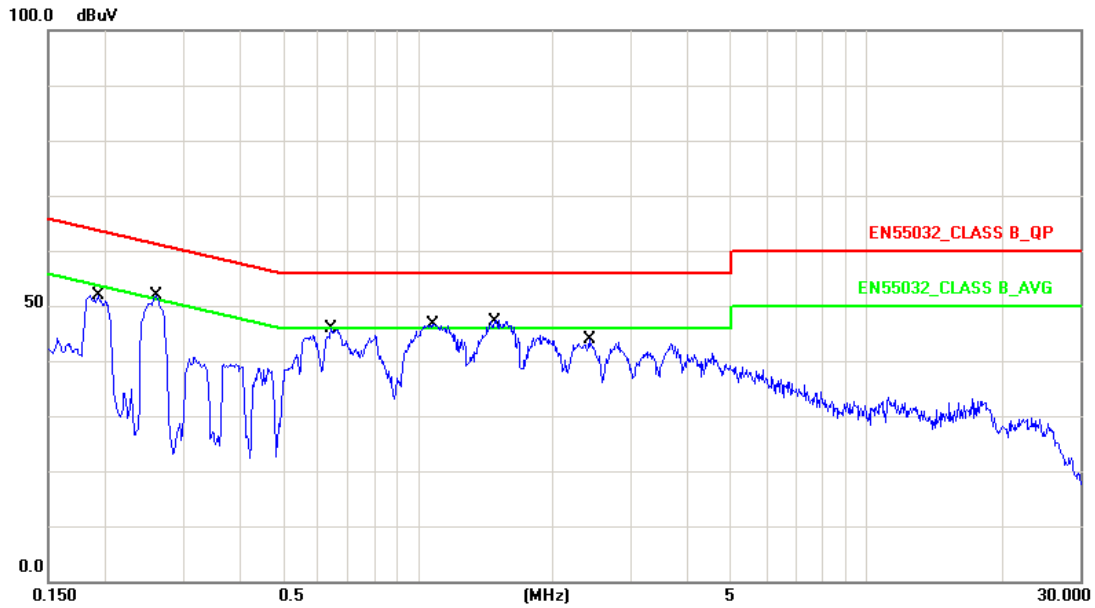

No.	Frequency (MHz)	Factor (dB)	Reading (dBuV)	Level (dBuV)	Limit (dBuV)	Margin (dB)	Detector
1	0.1940	10.13	45.55	55.68	63.86	-8.18	QP
2	0.1940	10.13	39.22	49.35	53.86	-4.51	AVG
3	0.2600	10.13	41.75	51.88	61.43	-9.55	QP
4	0.2600	10.13	35.29	45.42	51.43	-6.01	AVG
5	0.6419	10.16	38.09	48.25	56.00	-7.75	QP
6	0.6419	10.16	25.01	35.17	46.00	-10.83	AVG
7	1.0820	10.18	35.14	45.32	56.00	-10.68	QP
8	1.0820	10.18	21.23	31.41	46.00	-14.59	AVG
9	1.4617	10.18	35.44	45.62	56.00	-10.38	QP
10	1.4617	10.18	22.86	33.04	46.00	-12.96	AVG
11	2.4140	10.19	33.03	43.22	56.00	-12.78	QP
12	2.4140	10.19	22.62	32.81	46.00	-13.19	AVG

Note: Measurement Level = Reading Level + Correct Factor



Test Mode :	Mode 20: Full system (VGA mode 1920*1080@60Hz) Signal from PC for Horizontal (110V/60Hz)		
AC Power :	AC 110V/60Hz	Phase :	LINE
Equipment :	LCD Monitor	Model No :	270LM00043
Temperature :	25°C	Humidity :	52%
Pressure(mbar) :	1001	Date:	2017/05/16

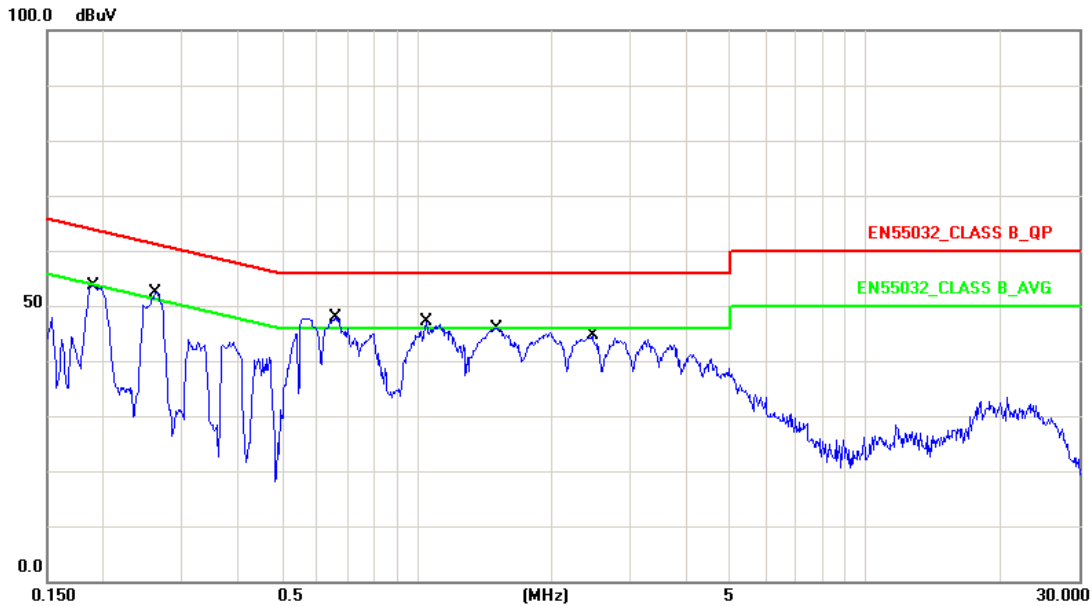

No.	Frequency (MHz)	Factor (dB)	Reading (dBuV)	Level (dBuV)	Limit (dBuV)	Margin (dB)	Detector
1	0.1900	10.12	45.74	55.86	64.03	-8.17	QP
2	0.1900	10.12	39.49	49.61	54.03	-4.42	AVG
3	0.2620	10.13	41.63	51.76	61.36	-9.60	QP
4	0.2620	10.13	34.98	45.11	51.36	-6.25	AVG
5	0.6580	10.15	38.98	49.13	56.00	-6.87	QP
6	0.6580	10.15	25.84	35.99	46.00	-10.01	AVG
7	1.0540	10.16	35.17	45.33	56.00	-10.67	QP
8	1.0540	10.16	23.92	34.08	46.00	-11.92	AVG
9	1.5100	10.17	36.08	46.25	56.00	-9.75	QP
10	1.5100	10.17	23.19	33.36	46.00	-12.64	AVG
11	2.4660	10.18	32.17	42.35	56.00	-13.65	QP
12	2.4660	10.18	20.57	30.75	46.00	-15.25	AVG

Note: Measurement Level = Reading Level + Correct Factor



Test Mode :	Mode 20: Full system (VGA mode 1920*1080@60Hz) Signal from PC for Horizontal (110V/60Hz)		
AC Power :	AC 110V/60Hz	Phase :	NEUTRAL
Equipment :	LCD Monitor	Model No :	270LM00043
Temperature :	25°C	Humidity :	52%
Pressure(mbar) :	1001	Date:	2017/05/16

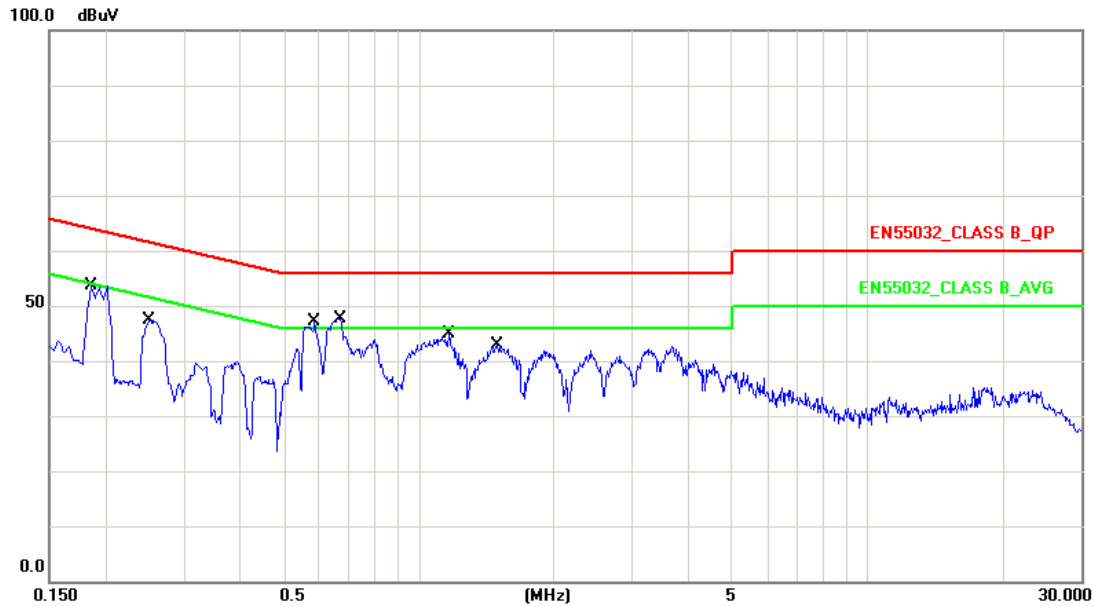

No.	Frequency (MHz)	Factor (dB)	Reading (dBuV)	Level (dBuV)	Limit (dBuV)	Margin (dB)	Detector
1	0.1859	10.13	45.42	55.55	64.21	-8.66	QP
2	0.1859	10.13	35.38	45.51	54.21	-8.70	AVG
3	0.2500	10.13	42.32	52.45	61.75	-9.30	QP
4	0.2500	10.13	33.45	43.58	51.75	-8.17	AVG
5	0.5860	10.15	37.23	47.38	56.00	-8.62	QP
6	0.5860	10.15	26.00	36.15	46.00	-9.85	AVG
7	0.6700	10.16	38.71	48.87	56.00	-7.13	QP
8	0.6700	10.16	22.70	32.86	46.00	-13.14	AVG
9	1.1660	10.18	34.72	44.90	56.00	-11.10	QP
10	1.1660	10.18	21.95	32.13	46.00	-13.87	AVG
11	1.4979	10.18	35.99	46.17	56.00	-9.83	QP
12	1.4979	10.18	23.16	33.34	46.00	-12.66	AVG

Note: Measurement Level = Reading Level + Correct Factor



Test Mode :	Mode 21: Full system (HDMI 1 mode 2560*1440@60Hz) Signal from PC for Horizontal (110V/60Hz)		
AC Power :	AC 110V/60Hz	Phase :	LINE
Equipment :	LCD Monitor	Model No :	270LM00043
Temperature :	25°C	Humidity :	52%
Pressure(mbar) :	1001	Date:	2017/05/16

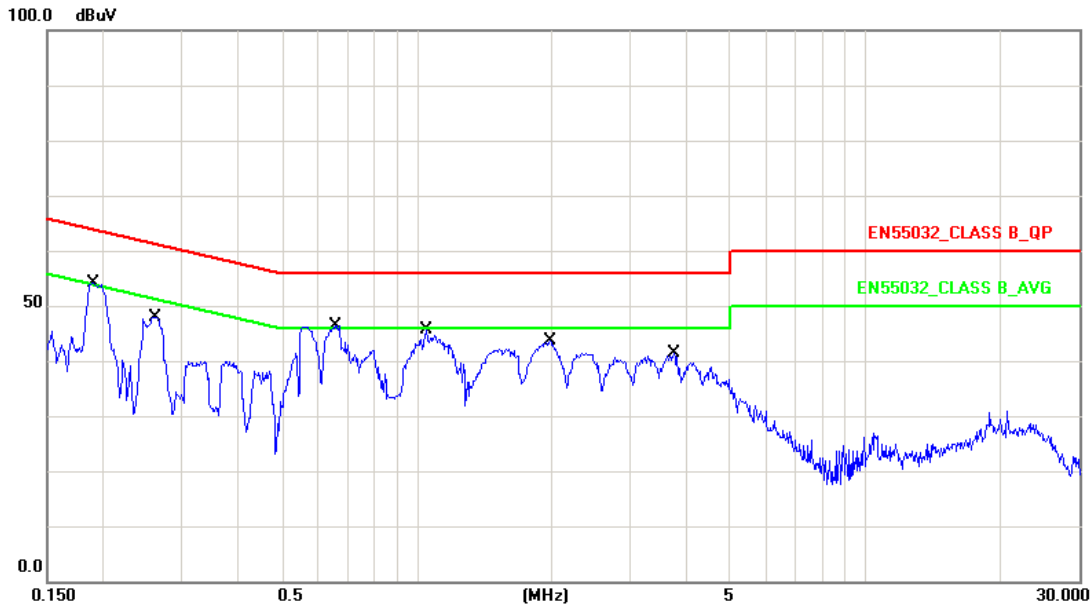

No.	Frequency (MHz)	Factor (dB)	Reading (dBuV)	Level (dBuV)	Limit (dBuV)	Margin (dB)	Detector
1	0.1900	10.12	46.01	56.13	64.03	-7.90	QP
2	0.1900	10.12	39.65	49.77	54.03	-4.26	AVG
3	0.2620	10.13	41.79	51.92	61.36	-9.44	QP
4	0.2620	10.13	35.04	45.17	51.36	-6.19	AVG
5	0.6580	10.15	39.10	49.25	56.00	-6.75	QP
6	0.6580	10.15	26.02	36.17	46.00	-9.83	AVG
7	1.0540	10.16	35.27	45.43	56.00	-10.57	QP
8	1.0540	10.16	24.08	34.24	46.00	-11.76	AVG
9	1.9858	10.17	34.87	45.04	56.00	-10.96	QP
10	1.9858	10.17	23.41	33.58	46.00	-12.42	AVG
11	3.7419	10.20	29.11	39.31	56.00	-16.69	QP
12	3.7419	10.20	21.14	31.34	46.00	-14.66	AVG

Note: Measurement Level = Reading Level + Correct Factor



Test Mode : Mode 21: Full system (HDMI 1 mode 2560*1440@60Hz) Signal from PC for Horizontal (110V/60Hz)

AC Power : AC 110V/60Hz Phase : NEUTRAL

Equipment : LCD Monitor Model No : 270LM00043

Temperature : 25°C Humidity : 52%

Pressure(mbar) : 1001 Date: 2017/05/16

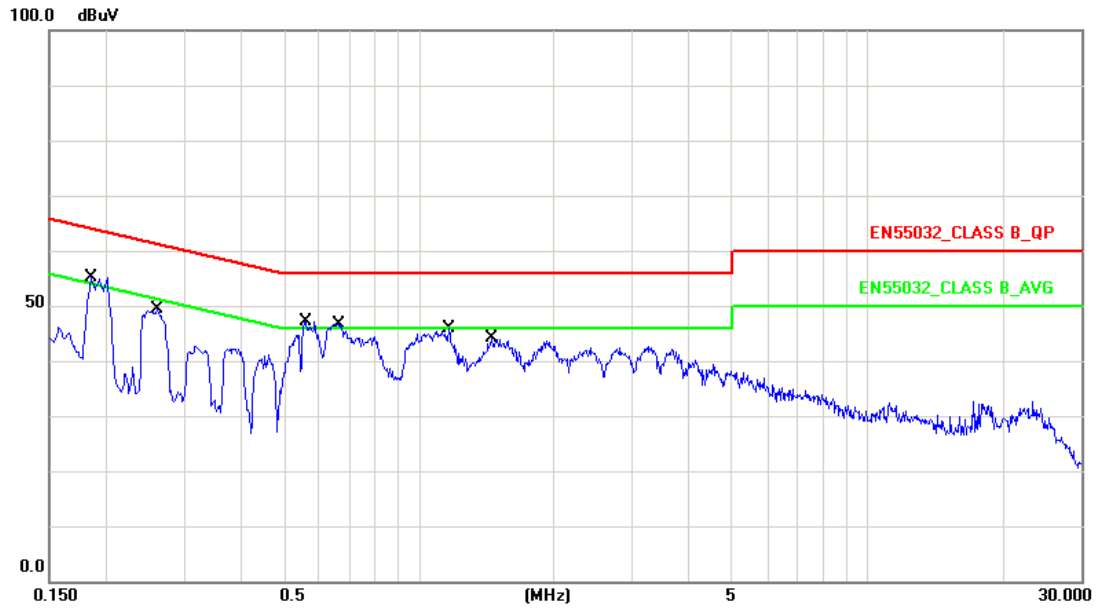

No.	Frequency (MHz)	Factor (dB)	Reading (dBuV)	Level (dBuV)	Limit (dBuV)	Margin (dB)	Detector
1	0.1859	10.13	45.56	55.69	64.21	-8.52	QP
2	0.1859	10.13	35.43	45.56	54.21	-8.65	AVG
3	0.2600	10.13	41.90	52.03	61.43	-9.40	QP
4	0.2600	10.13	35.44	45.57	51.43	-5.86	AVG
5	0.5620	10.15	38.71	48.86	56.00	-7.14	QP
6	0.5620	10.15	25.26	35.41	46.00	-10.59	AVG
7	0.6660	10.16	39.04	49.20	56.00	-6.80	QP
8	0.6660	10.16	24.48	34.64	46.00	-11.36	AVG
9	1.1660	10.18	34.74	44.92	56.00	-11.08	QP
10	1.1660	10.18	21.91	32.09	46.00	-13.91	AVG
11	1.4616	10.18	35.51	45.69	56.00	-10.31	QP
12	1.4616	10.18	22.84	33.02	46.00	-12.98	AVG

Note: Measurement Level = Reading Level + Correct Factor



Test Mode :	Mode 22: Full system (HDMI 2 mode 2560*1440@60Hz) Signal from PC for Horizontal (110V/60Hz)		
AC Power :	AC 110V/60Hz	Phase :	LINE
Equipment :	LCD Monitor	Model No :	270LM00043
Temperature :	25°C	Humidity :	52%
Pressure(mbar) :	1001	Date:	2017/05/16

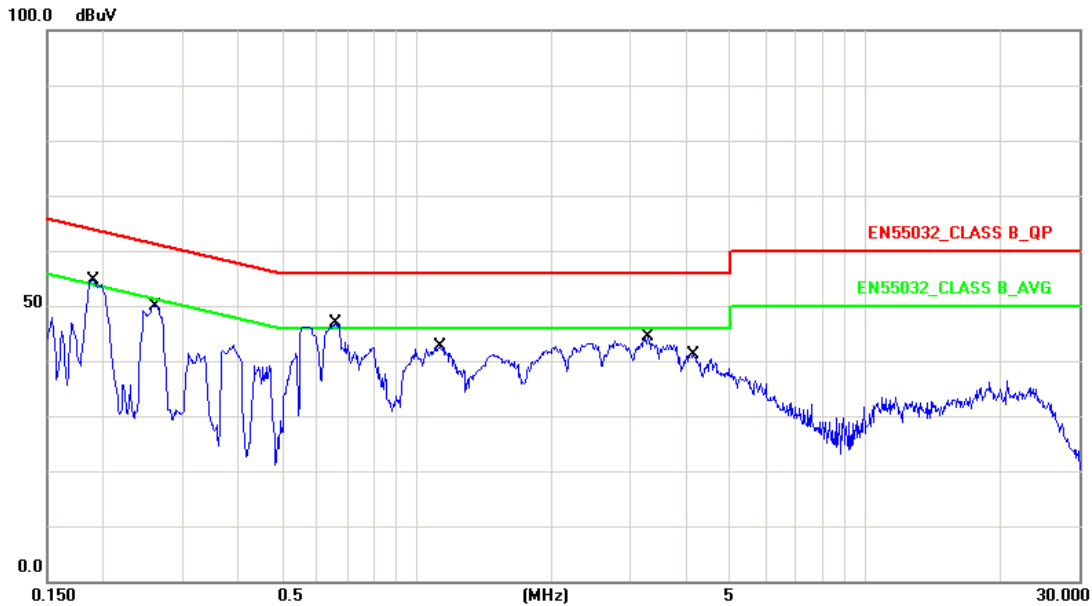

No.	Frequency (MHz)	Factor (dB)	Reading (dBuV)	Level (dBuV)	Limit (dBuV)	Margin (dB)	Detector
1	0.1900	10.12	46.03	56.15	64.03	-7.88	QP
2	0.1900	10.12	39.73	49.85	54.03	-4.18	AVG
3	0.2620	10.13	41.84	51.97	61.36	-9.39	QP
4	0.2620	10.13	35.18	45.31	51.36	-6.05	AVG
5	0.6580	10.15	39.13	49.28	56.00	-6.72	QP
6	0.6580	10.15	25.98	36.13	46.00	-9.87	AVG
7	1.1340	10.16	36.26	46.42	56.00	-9.58	QP
8	1.1340	10.16	23.86	34.02	46.00	-11.98	AVG
9	3.2860	10.19	31.20	41.39	56.00	-14.61	QP
10	3.2860	10.19	23.32	33.51	46.00	-12.49	AVG
11	4.1459	10.21	27.36	37.57	56.00	-18.43	QP
12	4.1459	10.21	18.91	29.12	46.00	-16.88	AVG

Note: Measurement Level = Reading Level + Correct Factor



Test Mode :	Mode 22: Full system (HDMI 2 mode 2560*1440@60Hz) Signal from PC for Horizontal (110V/60Hz)		
AC Power :	AC 110V/60Hz	Phase :	NEUTRAL
Equipment :	LCD Monitor	Model No :	270LM00043
Temperature :	25°C	Humidity :	52%
Pressure(mbar) :	1001	Date:	2017/05/16

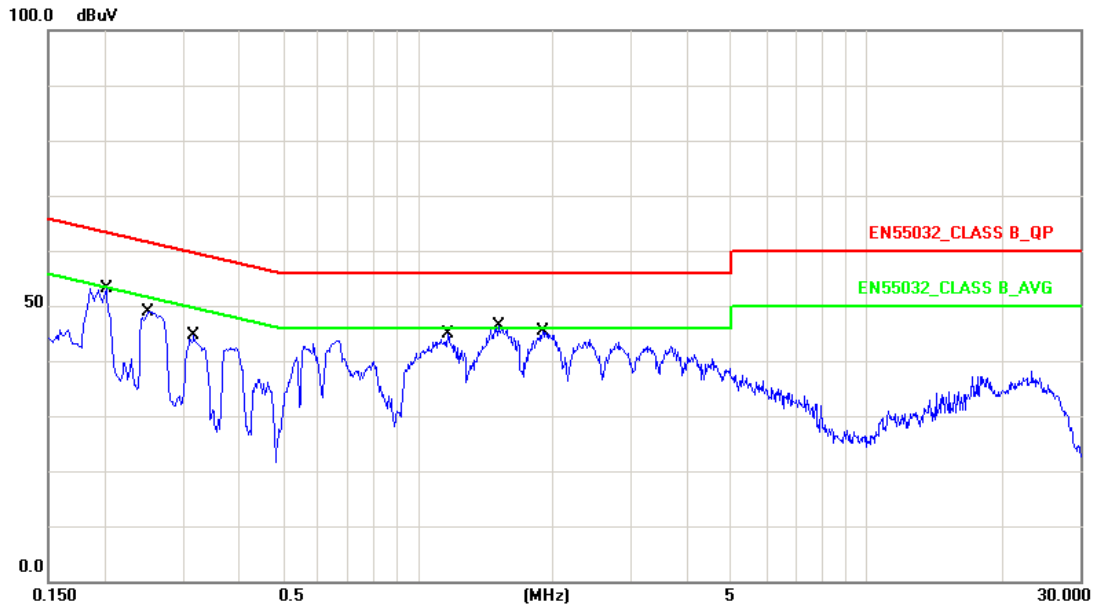

No.	Frequency (MHz)	Factor (dB)	Reading (dBuV)	Level (dBuV)	Limit (dBuV)	Margin (dB)	Detector
1	0.2020	10.13	44.97	55.10	63.52	-8.42	QP
2	0.2020	10.13	34.24	44.37	53.52	-9.15	AVG
3	0.2500	10.13	42.52	52.65	61.75	-9.10	QP
4	0.2500	10.13	33.65	43.78	51.75	-7.97	AVG
5	0.3180	10.14	33.39	43.53	59.76	-16.23	QP
6	0.3180	10.14	25.39	35.53	49.76	-14.23	AVG
7	1.1660	10.18	34.98	45.16	56.00	-10.84	QP
8	1.1660	10.18	22.19	32.37	46.00	-13.63	AVG
9	1.5140	10.18	36.24	46.42	56.00	-9.58	QP
10	1.5140	10.18	23.30	33.48	46.00	-12.52	AVG
11	1.9020	10.18	34.84	45.02	56.00	-10.98	QP
12	1.9020	10.18	21.84	32.02	46.00	-13.98	AVG

Note: Measurement Level = Reading Level + Correct Factor

Test engineer: Sun. Zhang



4.5.2 Conducted Emission for Telecommunication Port Test Data

Note: The EUT doesn't have the telecommunication port.



4.6. Test Photographs

Front View

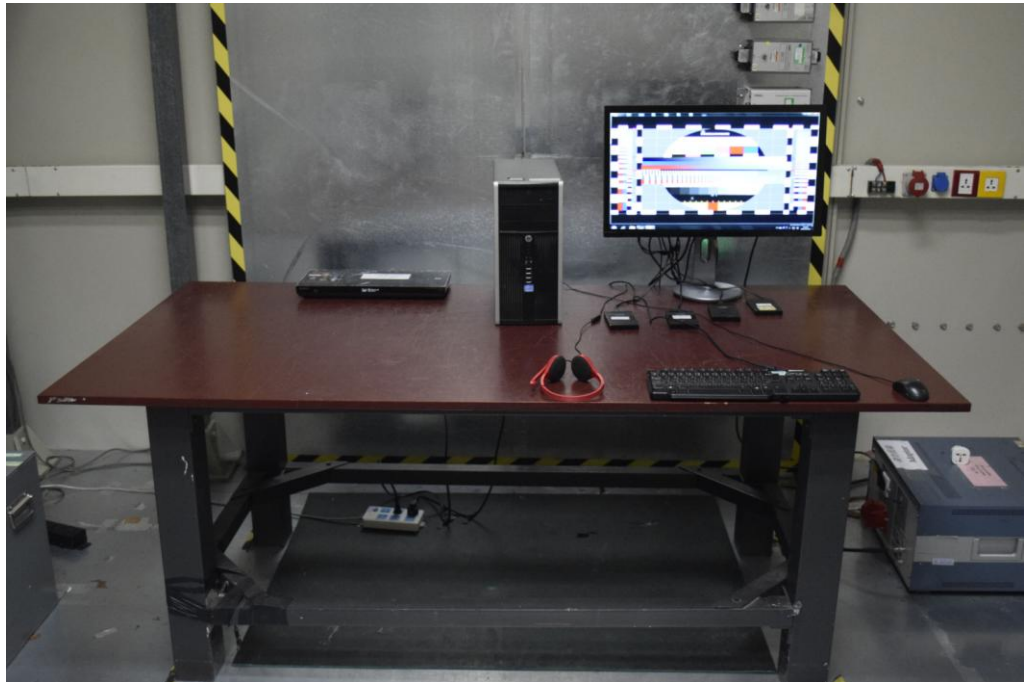

Rear View

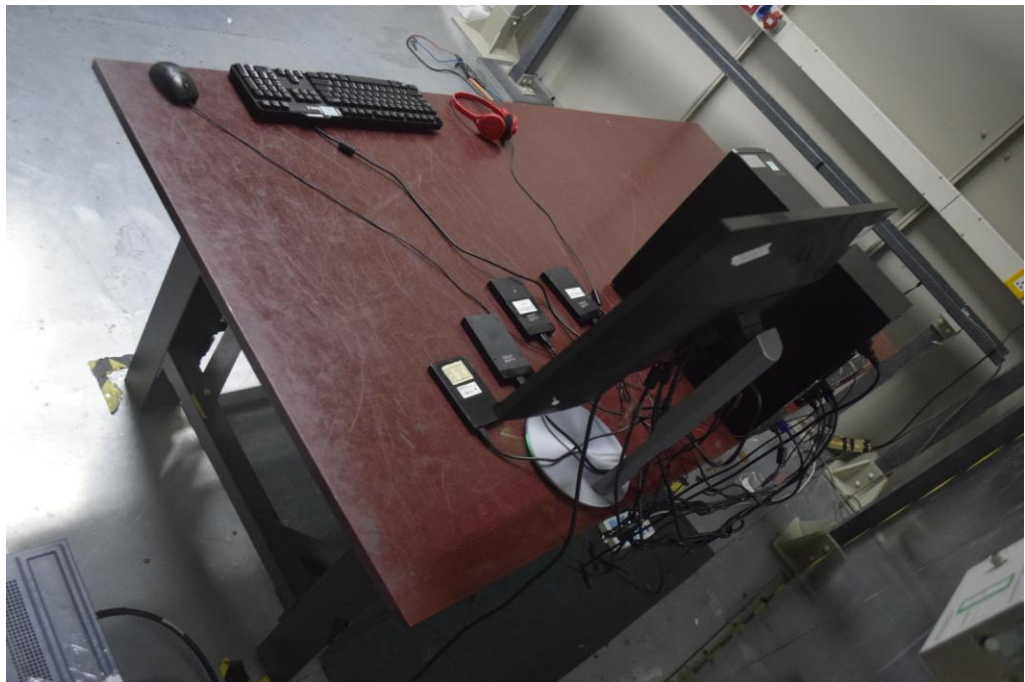



5. Test of Radiated Emission

5.1. Test Limit

The EUT shall meet the limits of below Table when measured at the measuring distance R in accordance with the methods described in European Standard EN 55032. If the reading on the measuring receiver shows fluctuations close to the limit, the reading shall be observed for at least 15 s at each measurement frequency; the highest reading shall be recorded, with the exception of any brief isolated high reading, which shall be ignored.

Table 1 – Required highest frequency for radiated measurement

Highest internal frequency (F_x)	Highest measured frequency
$F_x \leq 108$ MHz	1 GHz
108 MHz $< F_x \leq 500$ MHz	2 GHz
500 MHz $< F_x \leq 1$ GHz	5 GHz
$F_x > 1$ GHz	$5 \times F_x$ up to a maximum of 6 GHz

NOTE 1 For FM and TV broadcast receivers, F_x is determined from the highest frequency generated or used excluding the local oscillator and tuned frequencies.

NOTE 2 F_x is defined in 3.1.19.

Where the F_x is unknown, the radiated emission measurements shall be performed up to 6 GHz.

Table A.2 – Requirements for radiated emissions at frequencies up to 1 GHz for Class A equipment

Table clause	Frequency range MHz	Measurement		Class A limits dB(μ V/m)
		Distance m	Detector type/ bandwidth	OATS/SAC (see Table A.1)
A2.1	30 – 230	10	Quasi Peak / 120 kHz	40
	230 – 1 000			47
A2.2	30 – 230	3		50
	230 – 1 000			57

NOTE Apply only A2.1 or A2.2 across the entire frequency range.

Table A.3 – Requirements for radiated emissions at frequencies above 1 GHz for Class A equipment

Table clause	Frequency range MHz	Measurement		Class A limits dB(μ V/m)
		Distance m	Detector type/ bandwidth	FSOATS (see Table A.1)
A3.1	1 000 – 3 000	3	Average / 1 MHz	56
	3 000 – 6 000			60
A3.2	1 000 – 3 000		Peak / 1 MHz	76
	3 000 – 6 000			80

NOTE Apply A3.1 and A3.2 across the frequency range from 1 000 MHz to the highest required frequency of measurement derived from Table 1.



Table A.4 – Requirements for radiated emissions at frequencies up to 1 GHz for Class B equipment

Table clause	Frequency range MHz	Measurement		Class B limits dB(μV/m)	
		Distance m	Detector type/ bandwidth	OATS/SAC (see Table A.1)	
A4.1	30 – 230	10	Quasi Peak / 120 kHz	30	
	230 – 1 000			37	
A4.2	30 – 230	3		40	
	230 – 1 000			47	

NOTE Apply only table clause A4.1 or A4.2 across the entire frequency range.

Table A.5 – Requirements for radiated emissions at frequencies above 1 GHz for Class B equipment

Table clause	Frequency range MHz	Measurement		Class B limits dB(μV/m)	
		Distance m	Detector type/ bandwidth	FSOATS (see Table A.1)	
A5.1	1 000 – 3 000	3	Average/ 1 MHz	50	
	3 000 – 6 000			54	
A5.2	1 000 – 3 000		Peak/ 1 MHz	70	
	3 000 – 6 000			74	

NOTE Apply A5.1 and A5.2 across the frequency range from 1 000 MHz to the highest required frequency of measurement derived from Table 1.

Table A.6 – Requirements for radiated emissions from FM receivers

Table clause	Frequency range MHz	Measurement		Class B limit dB(μV/m)		
		Distance m	Detector type/ bandwidth	Fundamental	Harmonics	
				OATS/SAC (see Table A.1)	OATS/SAC (see Table A.1)	
A6.1	30 – 230	10	Quasi peak/ 120 kHz	50	42	
	230 – 300				42	
	300 – 1 000				46	
A6.2	30 – 230	3		Quasi peak/ 120 kHz	60	52
	230 – 300					52
	300 – 1 000					56

NOTE 1 Apply only A.6.1 or A.6.2 across the entire frequency range.

NOTE 2 These relaxed limits apply only to emissions at the fundamental and harmonic frequencies of the local oscillator. Signals at all other frequencies shall be compliant with the limits given in Table A.4.



Table A.12 – Requirements for conducted differential voltage emissions from Class B equipment

Applicable to						
1. TV broadcast receiver tuner ports (3.1.8) with an accessible connector						
2. RF modulator output ports (3.1.27)						
3. FM broadcast receiver tuner ports (3.1.8) with an accessible connector						
Table clause	Frequency range MHz	Detector type/ bandwidth	Class B limits dB(μV) 75 Ω			Applicability
			Other	Local Oscillator Fundamental	Local Oscillator Harmonics	
A12.1	30 – 950	For frequencies ≤1 GHz	46	46	46	See NOTE 1
	950 – 2 150		46	54	54	
A12.2	950 – 2 150		46	54	54	See NOTE 2
A12.3	30 – 300		Quasi Peak/ 120 kHz	46	54	50
	300 – 1 000	52				
A12.4	30 – 300	For frequencies ≥1 GHz	46	66	59	See NOTE 4
	300 – 1 000				52	
A12.5	30 – 950	Peak/ 1 MHz	46	76	46	See NOTE 5
	950 – 2 150			n/a	54	

NOTE 1 Television receivers (analogue or digital), video recorders and PC TV broadcast receiver tuner cards working in channels between 30 MHz and 1 GHz, and digital audio receivers.

NOTE 2 Tuner units (not the LNB) for satellite signal reception.

NOTE 3 Frequency modulation audio receivers and PC tuner cards.

NOTE 4 Frequency modulation car radios.

NOTE 5 Applicable to EUTs with RF modulator output ports (for example DVD equipment, video recorders, camcorders and decoders etc.) designed to connect to TV broadcast receiver tuner ports.

NOTE 6 Testing is required at only one EUT supply voltage and frequency.

NOTE 7 The term 'other' refers to all emissions other than the fundamental and the harmonics of the local oscillator.

NOTE 8 The test shall be performed with the device operating at each reception channel.

NOTE 9 The test shall cover the entire frequency range.

5.2. Test Procedures

- b. The EUT was placed on a rotatable table top 0.8 meter above ground.
- c. The EUT was set 3/10 meters from the interference receiving antenna which was mounted on the top of a variable height antenna tower.
- d. The table was rotated 360 degrees to determine the position of the highest radiation.
- e. The antenna is a half wave dipole and its height is varied between one meter and four meters above ground to find the maximum value of the field strength both horizontal polarization and vertical polarization of the antenna are set to make the measurement.
- f. For each suspected emission the EUT was arranged to its worst case and then tune the antenna tower (from 1 M to 4 M) and turn table (from 0 degree to 360 degrees) to find the maximum reading.
- g. Set the test-receiver system to Peak Detect Function and specified bandwidth with Maximum Hold Mode.
- h. If the emission level of the EUT in peak mode was 3 dB lower than the limit specified, then testing will be stopped and peak values of EUT will be reported, otherwise, the emissions which do not have 3 dB margin will be repeated one by one using the quasi-peak method and reported.

5.3. Typical Test Setup

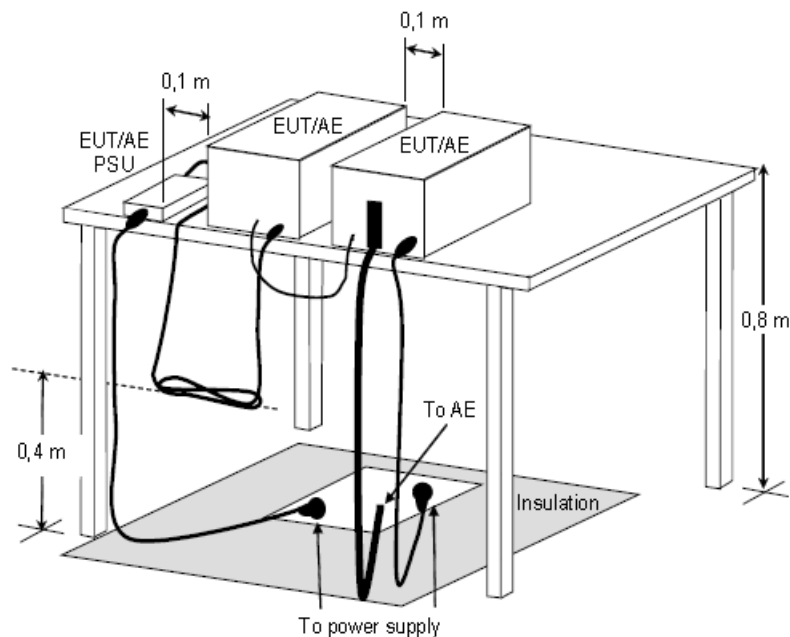

Figure D.8 – Example measurement arrangement for table-top EUT (Radiated emission measurement)



5.4. Measurement Equipment

Instrument/Ancillary	Manufacturer	Model No.	Serial No.	Calibration Date	Valid Date.
EMI Test Receiver	R&S	ESC17	100968	2016.07.21	2017.07.20
Preamplifier	Agilent	87405B	My39500554	2017.03.22	2018.03.21
Preamplifier	Agilent	8449B	3008A02342	2017.03.22	2018.03.21
Bilog Antenna	Sunol Science	JB1	A072414-1	2017.04.16	2018.04.15
Broad-Band Horn Antenna	Schwarzbeck	BBHA9120D	9120D-618	2017.04.16	2018.04.15
Spectrum Analyzer	R&S	FSP40	100324	2016.08.02	2017.08.01
Temperature/ Humidity Meter	Zhicheng	ZC1-11	CEP-TH-001	2017.03.28	2018.03.27
EZ-EMC	Fala	Ver CT3A1	N/A	N/A	N/A



5.5. Test Result and Data (30MHz ~ 1GHz)

Test Mode :	Mode 1: Full system (Display mode 2560*1440@60Hz) Signal from PC for Horizontal (230V/50Hz)		
AC Power :	AC 230V/50Hz	Ant. Polarization:	Horizontal
Equipment :	LCD Monitor	Model No :	270LM00043
Temperature :	25°C	Humidity :	52%
Pressure(mbar) :	1001	Date:	2017/05/16

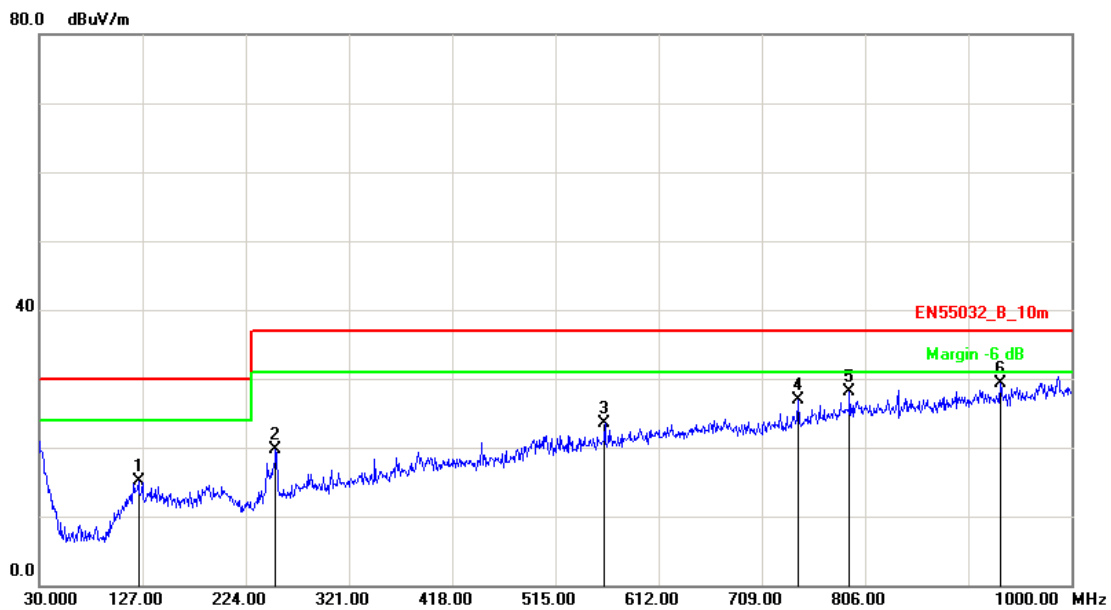

No.	Frequency (MHz)	Factor (dB/m)	Reading (dBuV)	Level (dBuV/m)	Limit (dBuV/m)	Margin (dB)	Det.	Height (cm)	Azimuth (deg)
1	123.1200	-9.69	24.70	15.01	30.00	-14.99	peak	400	256
2	252.1299	-10.36	30.02	19.66	37.00	-17.34	peak	100	302
3	561.5596	-1.84	25.38	23.54	37.00	-13.46	peak	100	152
4	742.9500	0.92	25.96	26.88	37.00	-10.12	peak	100	125
5	791.4500	1.95	26.07	28.02	37.00	-8.98	peak	100	2
6	933.0700	3.84	25.41	29.25	37.00	-7.75	peak	100	125

Note: Measurement Level = Reading Level + Correct Factor



Test Mode :	Mode 1: Full system (Display mode 2560*1440@60Hz) Signal from PC for Horizontal (230V/50Hz)		
AC Power :	AC 230V/50Hz	Ant. Polarization:	Vertical
Equipment :	LCD Monitor	Model No :	270LM00043
Temperature :	25°C	Humidity :	52%
Pressure(mbar) :	1001	Date:	2017/05/16

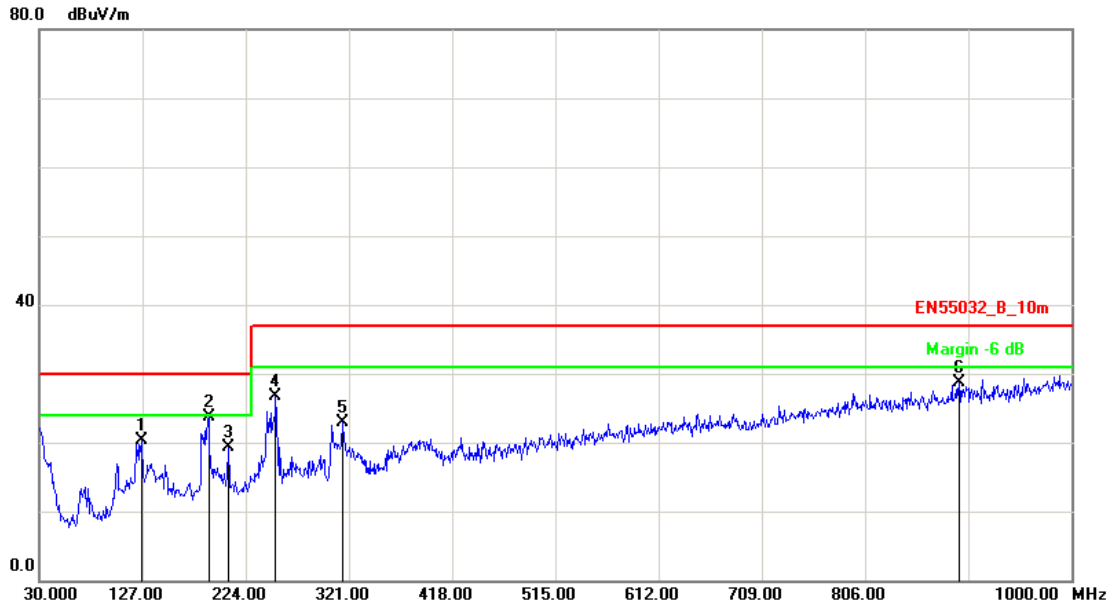

No.	Frequency (MHz)	Factor (dB/m)	Reading (dBuV)	Level (dBuV/m)	Limit (dBuV/m)	Margin (dB)	Det.	Height (cm)	Azimuth (deg)
1	126.0300	-9.81	30.11	20.30	30.00	-9.70	peak	400	124
2	189.0800	-10.77	34.51	23.74	30.00	-6.26	peak	100	155
3	207.5099	-10.67	29.91	19.24	30.00	-10.76	peak	400	265
4	252.1299	-10.36	37.04	26.68	37.00	-10.32	peak	100	1
5	315.1800	-8.20	31.06	22.86	37.00	-14.14	peak	100	245
6	894.2699	3.38	25.31	28.69	37.00	-8.31	peak	100	225

Note: Measurement Level = Reading Level + Correct Factor



Test Mode :	Mode 5: Full system (VGA mode 1920*1080@60Hz) Signal from PC for Horizontal (230V/50Hz)		
AC Power :	AC 230V/50Hz	Ant. Polarization:	Horizontal
Equipment :	LCD Monitor	Model No :	270LM00043
Temperature :	25°C	Humidity :	52%
Pressure(mbar) :	1001	Date:	2017/05/16

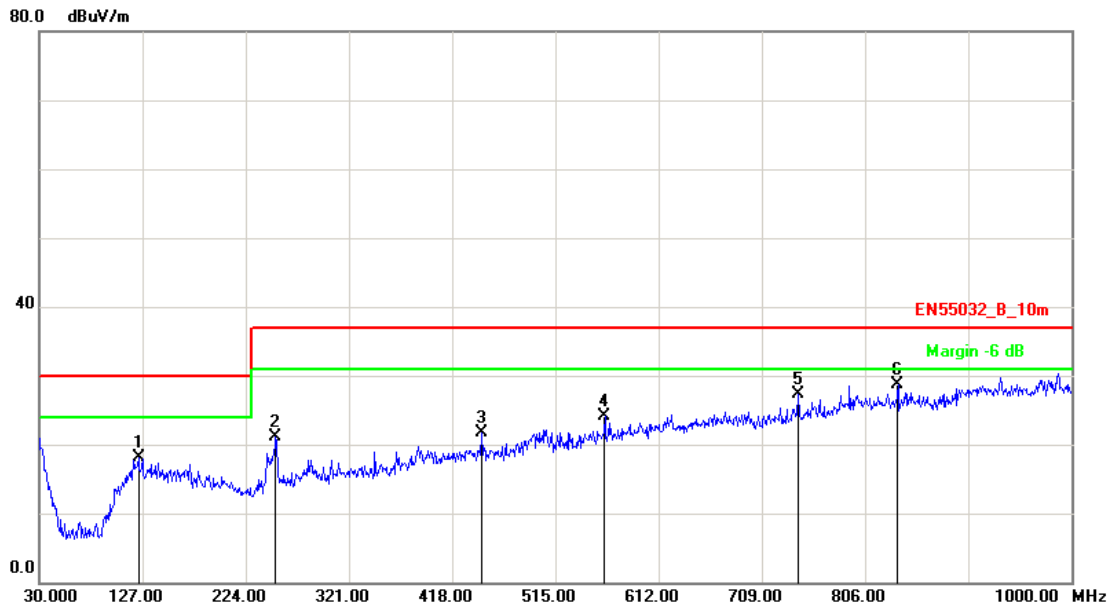

No.	Frequency (MHz)	Factor (dB/m)	Reading (dBuV)	Level (dBuV/m)	Limit (dBuV/m)	Margin (dB)	Det.	Height (cm)	Azimuth (deg)
1	123.1200	-9.69	27.70	18.01	30.00	-11.99	peak	400	147
2	252.1299	-10.36	31.52	21.16	37.00	-15.84	peak	100	124
3	446.1299	-4.65	26.27	21.62	37.00	-15.38	peak	400	125
4	561.5596	-1.84	25.88	24.04	37.00	-12.96	peak	100	60
5	742.9500	0.92	26.46	27.38	37.00	-9.62	peak	100	155
6	837.0398	2.45	26.30	28.75	37.00	-8.25	peak	100	25

Note: Measurement Level = Reading Level + Correct Factor



Test Mode :	Mode 5: Full system (VGA mode 1920*1080@60Hz) Signal from PC for Horizontal (230V/50Hz)		
AC Power :	AC 230V/50Hz	Ant. Polarization:	Vertical
Equipment :	LCD Monitor	Model No :	270LM00043
Temperature :	25°C	Humidity :	52%
Pressure(mbar) :	1001	Date:	2017/05/16

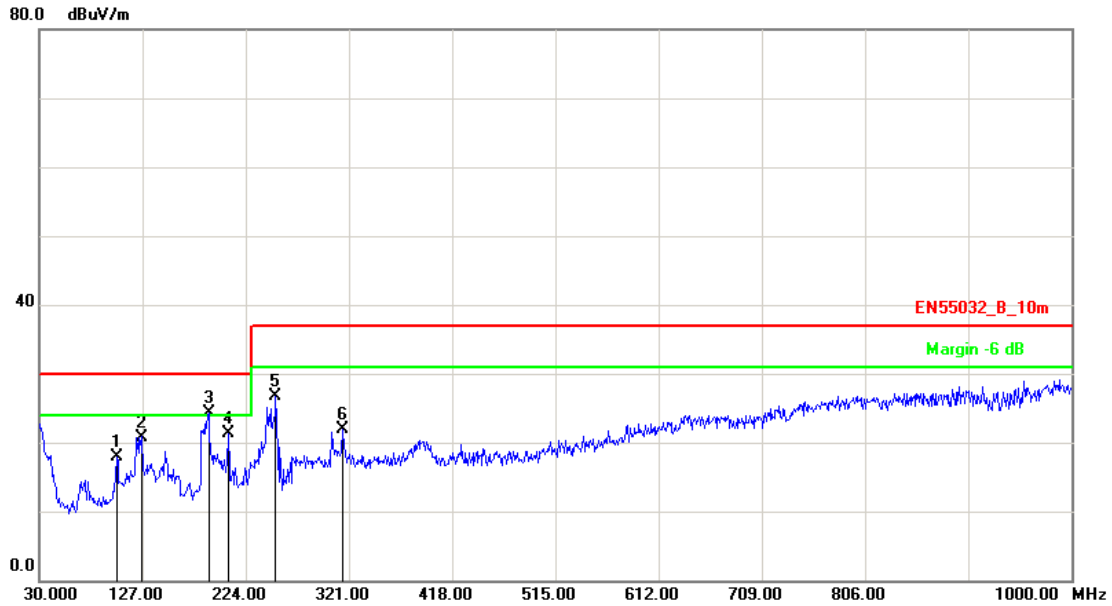

No.	Frequency (MHz)	Factor (dB/m)	Reading (dBuV)	Level (dBuV/m)	Limit (dBuV/m)	Margin (dB)	Det.	Height (cm)	Azimuth (deg)
1	102.7500	-13.22	31.07	17.85	30.00	-12.15	peak	400	214
2	126.0300	-9.81	30.61	20.80	30.00	-9.20	peak	100	57
3	189.0800	-10.77	35.01	24.24	30.00	-5.76	peak	400	152
4	207.5099	-10.67	31.91	21.24	30.00	-8.76	peak	400	35
5	252.1299	-10.36	37.04	26.68	37.00	-10.32	peak	100	62
6	315.1800	-8.20	30.06	21.86	37.00	-15.14	peak	100	215

Note: Measurement Level = Reading Level + Correct Factor



Test Mode :	Mode 9: Full system (HDMI 1 mode 2560*1440@60Hz) Signal from PC for Horizontal (230V/50Hz)		
AC Power :	AC 230V/50Hz	Ant. Polarization:	Horizontal
Equipment :	LCD Monitor	Model No :	270LM00043
Temperature :	25°C	Humidity :	52%
Pressure(mbar) :	1001	Date:	2017/05/16

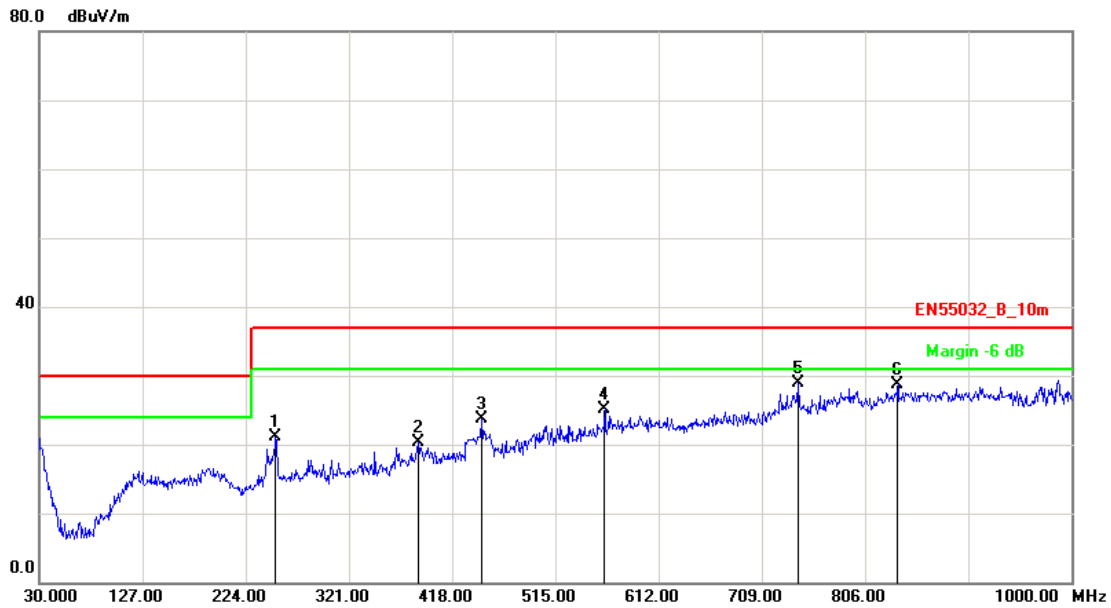

No.	Frequency (MHz)	Factor (dB/m)	Reading (dBuV)	Level (dBuV/m)	Limit (dBuV/m)	Margin (dB)	Det.	Height (cm)	Azimuth (deg)
1	252.1299	-10.36	31.52	21.16	37.00	-15.84	peak	400	124
2	385.9900	-6.03	26.31	20.28	37.00	-16.72	peak	100	15
3	446.1299	-4.65	28.27	23.62	37.00	-13.38	peak	100	265
4	561.5596	-1.84	26.88	25.04	37.00	-11.96	peak	100	12
5	742.9500	0.92	27.96	28.88	37.00	-8.12	peak	400	255
6	837.0398	2.45	26.30	28.75	37.00	-8.25	peak	400	302

Note: Measurement Level = Reading Level + Correct Factor



Test Mode :	Mode 9: Full system (HDMI 1 mode 2560*1440@60Hz) Signal from PC for Horizontal (230V/50Hz)		
AC Power :	AC 230V/50Hz	Ant. Polarization:	Vertical
Equipment :	LCD Monitor	Model No :	270LM00043
Temperature :	25°C	Humidity :	52%
Pressure(mbar) :	1001	Date:	2017/05/16

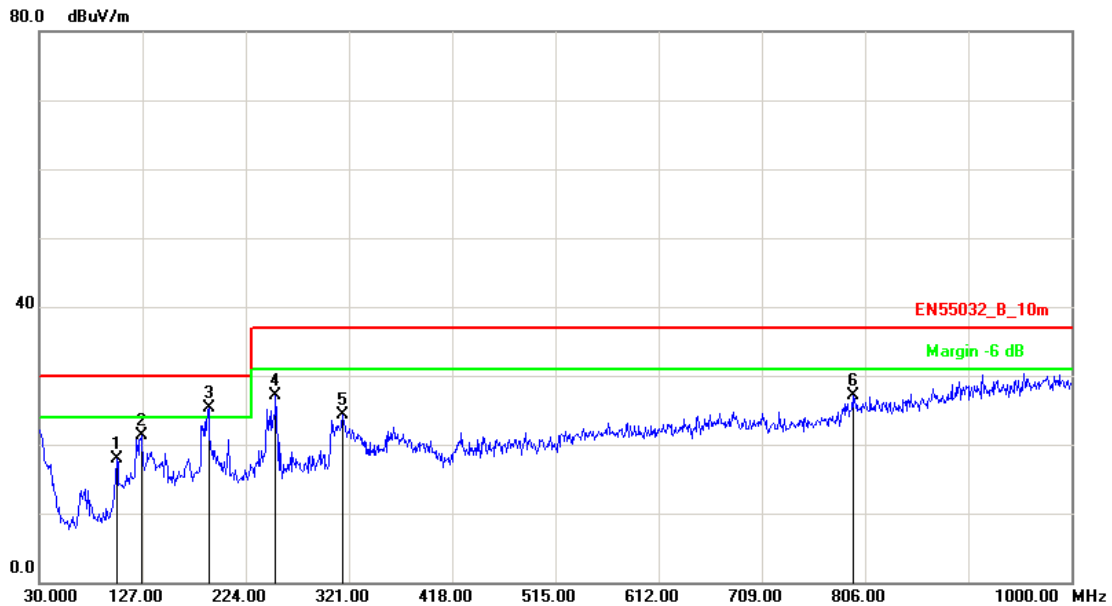

No.	Frequency (MHz)	Factor (dB/m)	Reading (dBuV)	Level (dBuV/m)	Limit (dBuV/m)	Margin (dB)	Det.	Height (cm)	Azimuth (deg)
1	102.7500	-13.22	31.07	17.85	30.00	-12.15	peak	100	124
2	126.0300	-9.81	31.11	21.30	30.00	-8.70	peak	400	155
3	189.0800	-10.77	36.01	25.24	30.00	-4.76	peak	100	202
4	252.1299	-10.36	37.54	27.18	37.00	-9.82	peak	400	1
5	315.1800	-8.20	32.56	24.36	37.00	-12.64	peak	400	12
6	794.3600	1.99	25.07	27.06	37.00	-9.94	peak	100	305

Note: Measurement Level = Reading Level + Correct Factor



Test Mode :	Mode 14: Full system (HDMI 2 mode 2560*1440@60Hz) Signal from PC for Horizontal (230V/50Hz)		
AC Power :	AC 230V/50Hz	Ant. Polarization:	Horizontal
Equipment :	LCD Monitor	Model No :	270LM00043
Temperature :	25°C	Humidity :	52%
Pressure(mbar) :	1001	Date:	2017/05/16

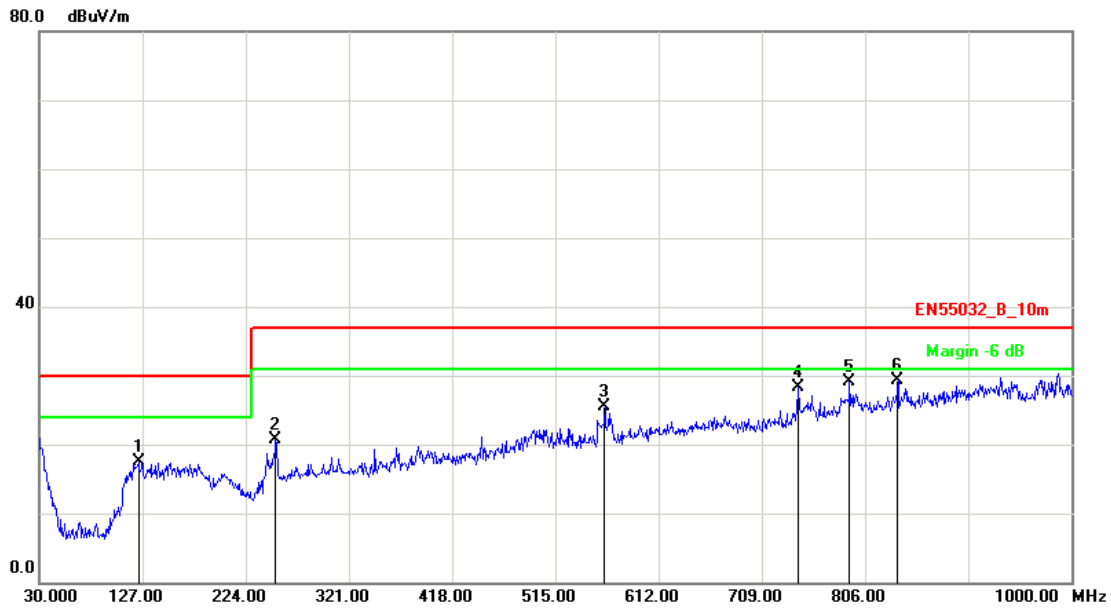

No.	Frequency (MHz)	Factor (dB/m)	Reading (dBuV)	Level (dBuV/m)	Limit (dBuV/m)	Margin (dB)	Det.	Height (cm)	Azimuth (deg)
1	123.1200	-9.69	27.20	17.51	30.00	-12.49	peak	100	20
2	252.1299	-10.36	31.02	20.66	37.00	-16.34	peak	400	3
3	561.5596	-1.84	27.38	25.54	37.00	-11.46	peak	100	310
4	742.9500	0.92	27.46	28.38	37.00	-8.62	peak	400	30
5	791.4500	1.95	27.07	29.02	37.00	-7.98	peak	100	203
6	837.0398	2.45	26.80	29.25	37.00	-7.75	peak	100	102

Note: Measurement Level = Reading Level + Correct Factor



Test Mode :	Mode 14: Full system (HDMI 2 mode 2560*1440@60Hz) Signal from PC for Horizontal (230V/50Hz)		
AC Power :	AC 230V/50Hz	Ant. Polarization:	Vertical
Equipment :	LCD Monitor	Model No :	270LM00043
Temperature :	25°C	Humidity :	52%
Pressure(mbar) :	1001	Date:	2017/05/16

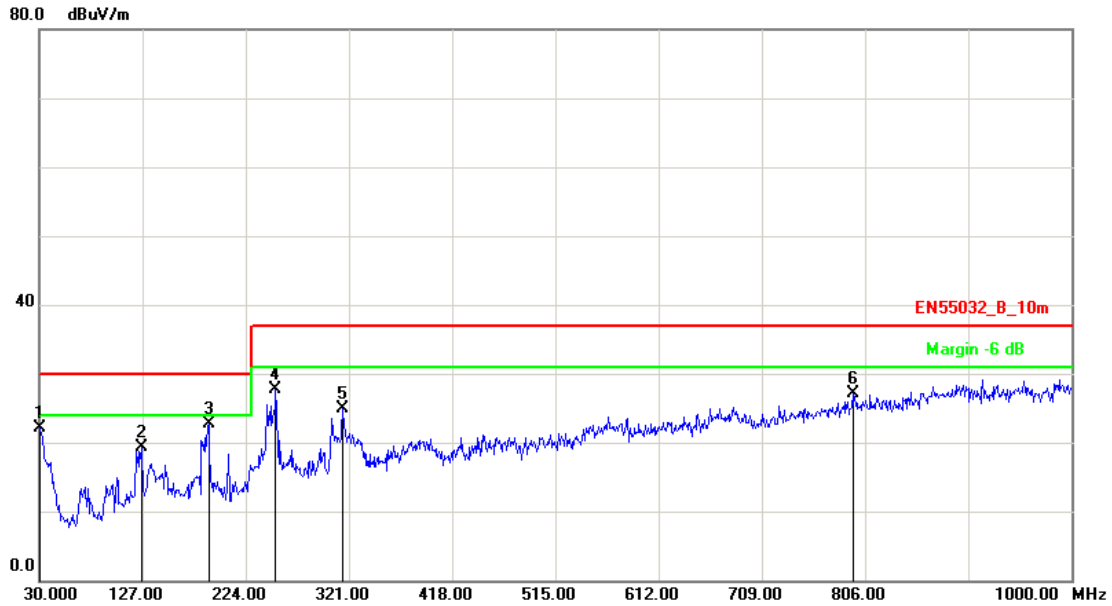

No.	Frequency (MHz)	Factor (dB/m)	Reading (dBuV)	Level (dBuV/m)	Limit (dBuV/m)	Margin (dB)	Det.	Height (cm)	Azimuth (deg)
1	30.0000	-3.26	25.40	22.14	30.00	-7.86	peak	400	256
2	126.0300	-9.81	29.11	19.30	30.00	-10.70	peak	400	265
3	189.0800	-10.77	33.51	22.74	30.00	-7.26	peak	400	301
4	252.1299	-10.36	38.04	27.68	37.00	-9.32	peak	100	54
5	315.1800	-8.20	33.06	24.86	37.00	-12.14	peak	100	124
6	794.3600	1.99	25.07	27.06	37.00	-9.94	peak	100	249

Note: Measurement Level = Reading Level + Correct Factor



Test Mode :	Mode 19: Full system (Display mode 2560*1440@60Hz) Signal from PC for Horizontal (110V/60Hz)		
AC Power :	AC 110V/60Hz	Ant. Polarization:	Horizontal
Equipment :	LCD Monitor	Model No :	270LM00043
Temperature :	25°C	Humidity :	52%
Pressure(mbar) :	1001	Date:	2017/05/16

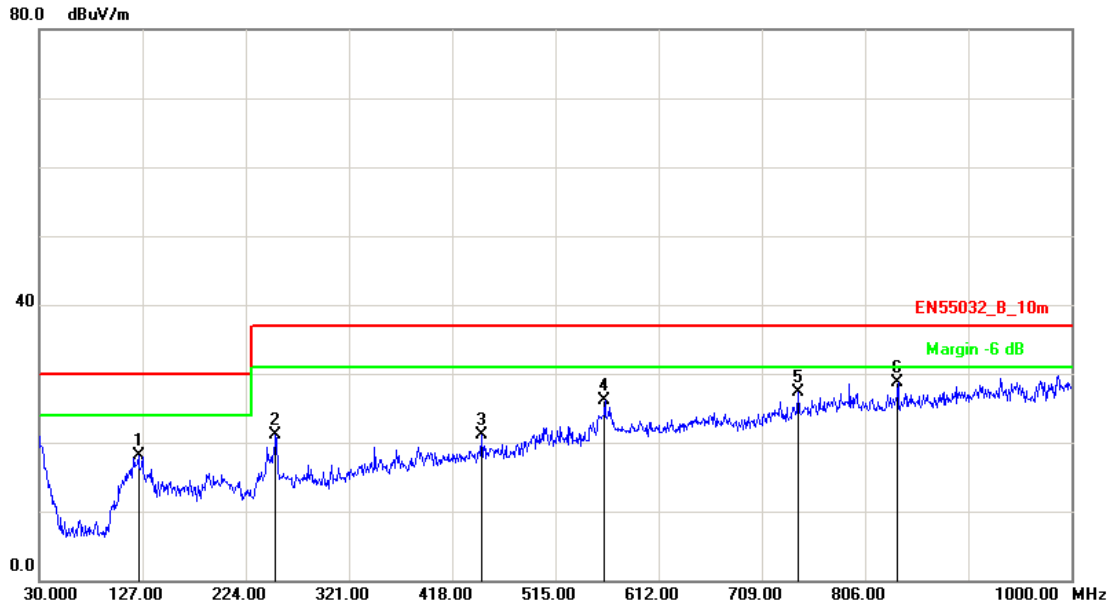

No.	Frequency (MHz)	Factor (dB/m)	Reading (dBuV)	Level (dBuV/m)	Limit (dBuV/m)	Margin (dB)	Det.	Height (cm)	Azimuth (deg)
1	123.1200	-9.69	27.70	18.01	30.00	-11.99	peak	400	214
2	252.1299	-10.36	31.52	21.16	37.00	-15.84	peak	100	178
3	446.1299	-4.65	25.77	21.12	37.00	-15.88	peak	100	198
4	561.5596	-1.84	27.88	26.04	37.00	-10.96	peak	400	62
5	742.9500	0.92	26.46	27.38	37.00	-9.62	peak	100	157
6	837.0398	2.45	26.30	28.75	37.00	-8.25	peak	400	230

Note: Measurement Level = Reading Level + Correct Factor



Test Mode :	Mode 19: Full system (Display mode 2560*1440@60Hz) Signal from PC for Horizontal (110V/60Hz)		
AC Power :	AC 110V/60Hz	Ant. Polarization:	Vertical
Equipment :	LCD Monitor	Model No :	270LM00043
Temperature :	25°C	Humidity :	52%
Pressure(mbar) :	1001	Date:	2017/05/16

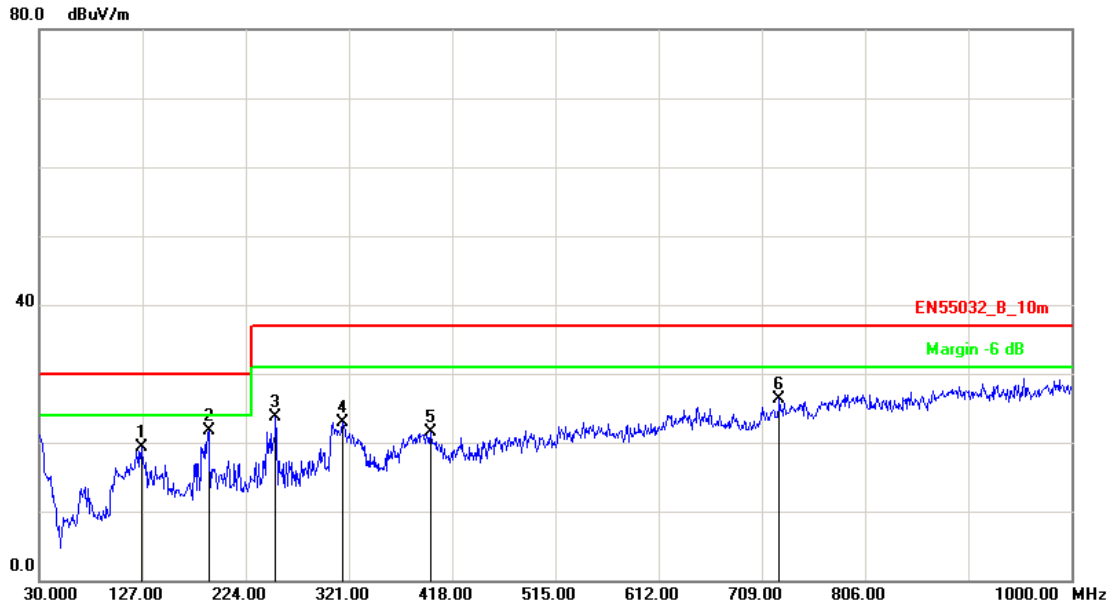

No.	Frequency (MHz)	Factor (dB/m)	Reading (dBuV)	Level (dBuV/m)	Limit (dBuV/m)	Margin (dB)	Det.	Height (cm)	Azimuth (deg)
1	126.0300	-9.81	29.11	19.30	30.00	-10.70	peak	400	214
2	189.0800	-10.77	32.51	21.74	30.00	-8.26	peak	100	57
3	252.1299	-10.36	34.04	23.68	37.00	-13.32	peak	400	298
4	315.1800	-8.20	31.06	22.86	37.00	-14.14	peak	100	316
5	397.6298	-5.39	26.85	21.46	37.00	-15.54	peak	400	1
6	725.4900	0.48	25.77	26.25	37.00	-10.75	peak	100	155

Note: Measurement Level = Reading Level + Correct Factor



Test Mode :	Mode 20: Full system (VGA mode 1920*1080@60Hz) Signal from PC for Horizontal (110V/60Hz)		
AC Power :	AC 110V/60Hz	Ant. Polarization:	Horizontal
Equipment :	LCD Monitor	Model No :	270LM00043
Temperature :	25°C	Humidity :	52%
Pressure(mbar) :	1001	Date:	2017/05/16

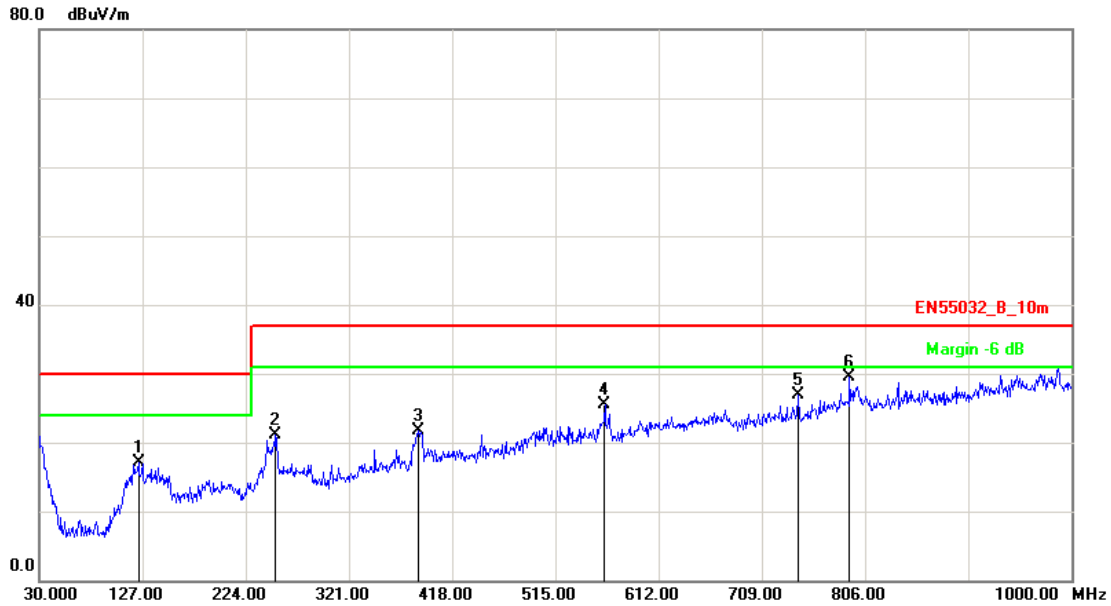

No.	Frequency (MHz)	Factor (dB/m)	Reading (dBuV)	Level (dBuV/m)	Limit (dBuV/m)	Margin (dB)	Det.	Height (cm)	Azimuth (deg)
1	123.1200	-9.69	26.70	17.01	30.00	-12.99	peak	400	214
2	252.1299	-10.36	31.52	21.16	37.00	-15.84	peak	400	158
3	385.9900	-6.03	27.81	21.78	37.00	-15.22	peak	100	268
4	561.5596	-1.84	27.38	25.54	37.00	-11.46	peak	100	305
5	742.9500	0.92	25.96	26.88	37.00	-10.12	peak	400	19
6	791.4500	1.95	27.57	29.52	37.00	-7.48	peak	100	256

Note: Measurement Level = Reading Level + Correct Factor



Test Mode :	Mode 20: Full system (VGA mode 1920*1080@60Hz) Signal from PC for Horizontal (110V/60Hz)		
AC Power :	AC 110V/60Hz	Ant. Polarization:	Vertical
Equipment :	LCD Monitor	Model No :	270LM00043
Temperature :	25°C	Humidity :	52%
Pressure(mbar) :	1001	Date:	2017/05/16

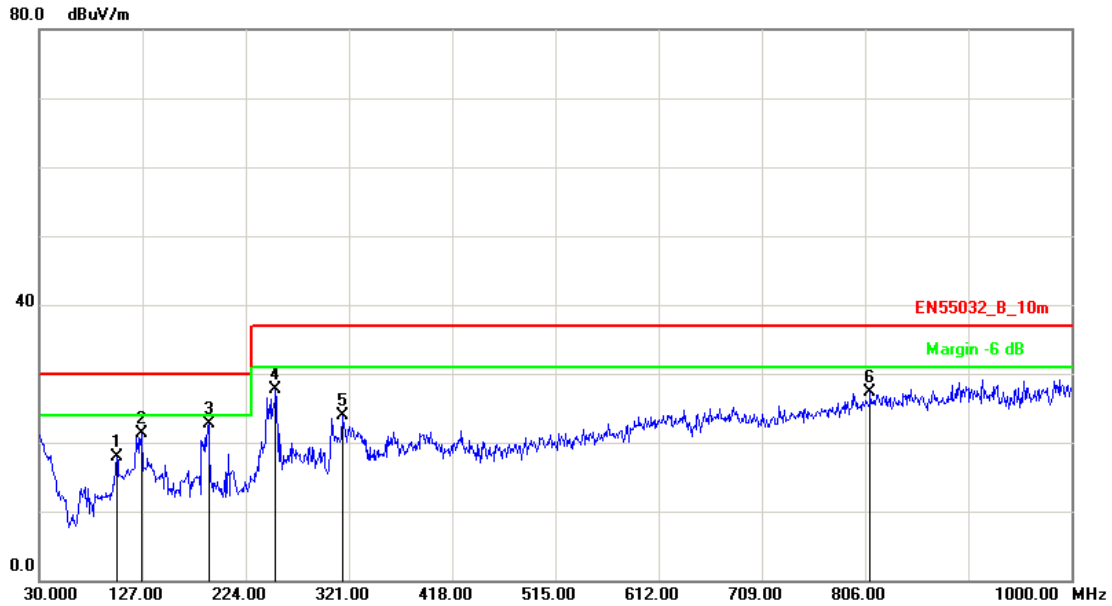

No.	Frequency (MHz)	Factor (dB/m)	Reading (dBuV)	Level (dBuV/m)	Limit (dBuV/m)	Margin (dB)	Det.	Height (cm)	Azimuth (deg)
1	102.7500	-13.22	31.07	17.85	30.00	-12.15	peak	400	124
2	126.0300	-9.81	31.11	21.30	30.00	-8.70	peak	100	155
3	189.0800	-10.77	33.51	22.74	30.00	-7.26	peak	400	60
4	252.1299	-10.36	38.04	27.68	37.00	-9.32	peak	100	125
5	315.1800	-8.20	32.06	23.86	37.00	-13.14	peak	100	259
6	810.8500	2.21	25.15	27.36	37.00	-9.64	peak	100	302

Note: Measurement Level = Reading Level + Correct Factor



Test Mode :	Mode 21: Full system (HDMI 1 mode 2560*1440@60Hz) Signal from PC for Horizontal (110V/60Hz)		
AC Power :	AC 110V/60Hz	Ant. Polarization:	Horizontal
Equipment :	LCD Monitor	Model No :	270LM00043
Temperature :	25°C	Humidity :	52%
Pressure(mbar) :	1001	Date:	2017/05/16

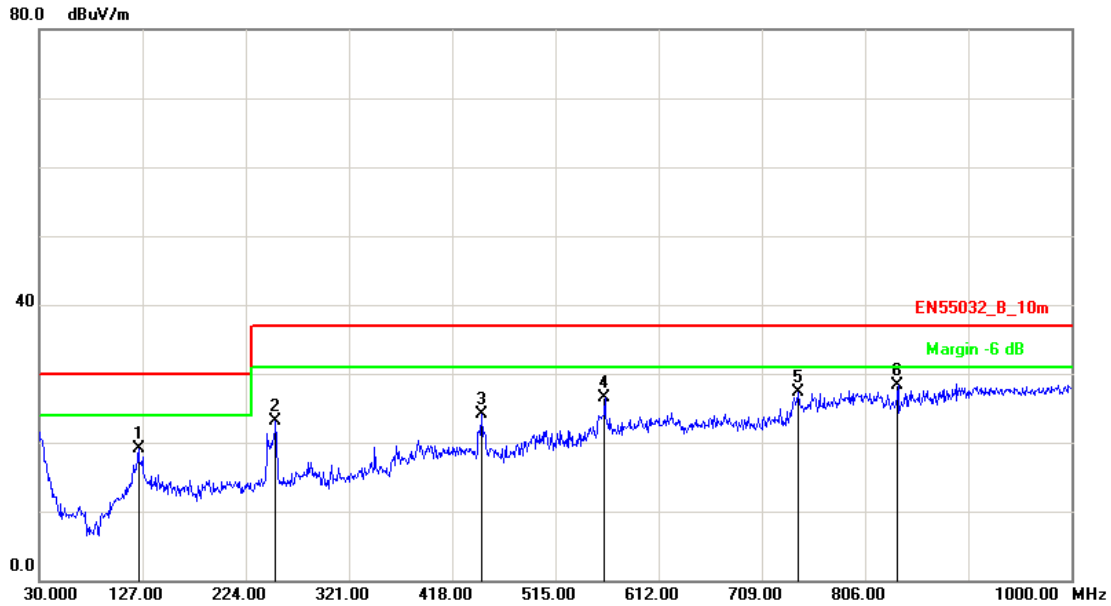

No.	Frequency (MHz)	Factor (dB/m)	Reading (dBuV)	Level (dBuV/m)	Limit (dBuV/m)	Margin (dB)	Det.	Height (cm)	Azimuth (deg)
1	123.1200	-9.69	28.70	19.01	30.00	-10.99	peak	400	214
2	252.1299	-10.36	33.52	23.16	37.00	-13.84	peak	100	158
3	446.1299	-4.65	28.77	24.12	37.00	-12.88	peak	400	265
4	561.5596	-1.84	28.38	26.54	37.00	-10.46	peak	100	30
5	742.9500	0.92	26.46	27.38	37.00	-9.62	peak	100	155
6	837.0398	2.45	25.80	28.25	37.00	-8.75	peak	100	22

Note: Measurement Level = Reading Level + Correct Factor



Test Mode :	Mode 21: Full system (HDMI 1 mode 2560*1440@60Hz) Signal from PC for Horizontal (110V/60Hz)		
AC Power :	AC 110V/60Hz	Ant. Polarization:	Vertical
Equipment :	LCD Monitor	Model No :	270LM00043
Temperature :	25°C	Humidity :	52%
Pressure(mbar) :	1001	Date:	2017/05/16

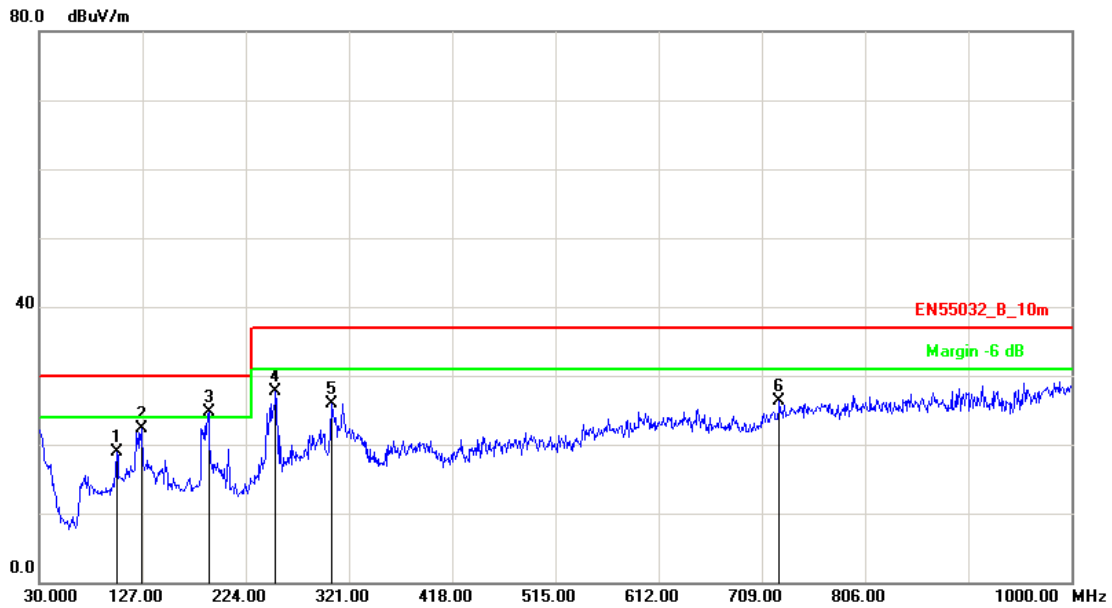

No.	Frequency (MHz)	Factor (dB/m)	Reading (dBuV)	Level (dBuV/m)	Limit (dBuV/m)	Margin (dB)	Det.	Height (cm)	Azimuth (deg)
1	102.7500	-13.22	32.07	18.85	30.00	-11.15	peak	400	124
2	126.0300	-9.81	32.11	22.30	30.00	-7.70	peak	400	158
3	189.0800	-10.77	35.51	24.74	30.00	-5.26	peak	400	265
4	252.1299	-10.36	38.04	27.68	37.00	-9.32	peak	100	120
5	304.5099	-8.59	34.52	25.93	37.00	-11.07	peak	100	2
6	725.4900	0.48	25.77	26.25	37.00	-10.75	peak	100	122

Note: Measurement Level = Reading Level + Correct Factor



Test Mode :	Mode 22: Full system (HDMI 2 mode 2560*1440@60Hz) Signal from PC for Horizontal (110V/60Hz)		
AC Power :	AC 110V/60Hz	Ant. Polarization:	Horizontal
Equipment :	LCD Monitor	Model No :	270LM00043
Temperature :	25°C	Humidity :	52%
Pressure(mbar) :	1001	Date:	2017/05/16

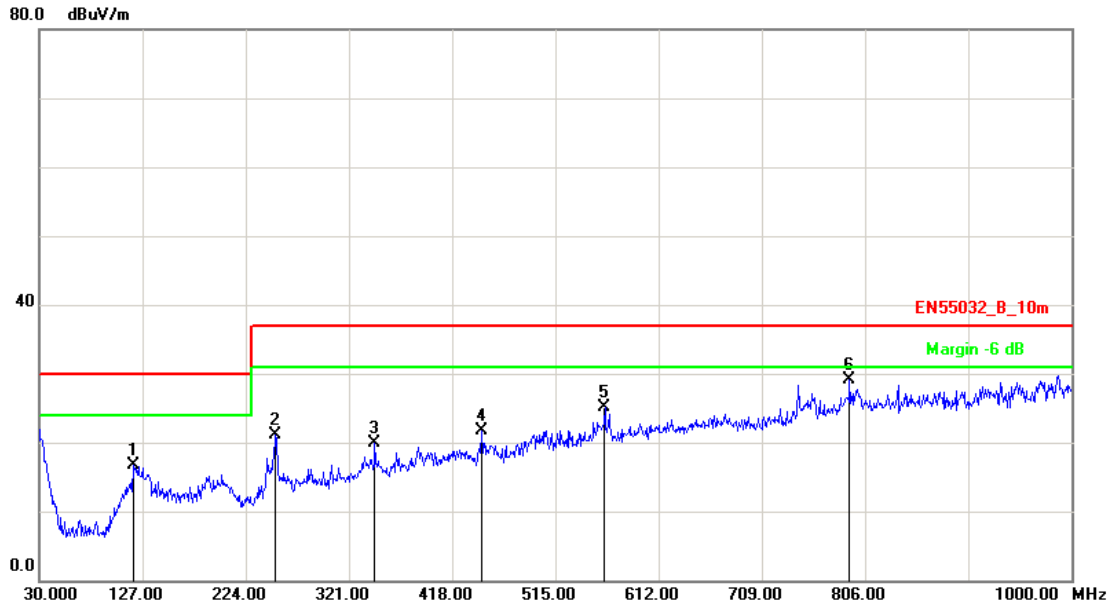

No.	Frequency (MHz)	Factor (dB/m)	Reading (dBuV)	Level (dBuV/m)	Limit (dBuV/m)	Margin (dB)	Det.	Height (cm)	Azimuth (deg)
1	118.2699	-9.92	26.53	16.61	30.00	-13.39	peak	400	124
2	252.1299	-10.36	31.52	21.16	37.00	-15.84	peak	100	155
3	345.2500	-7.55	27.37	19.82	37.00	-17.18	peak	100	22
4	446.1299	-4.65	26.27	21.62	37.00	-15.38	peak	100	330
5	561.5596	-1.84	26.88	25.04	37.00	-11.96	peak	400	155
6	791.4500	1.95	27.07	29.02	37.00	-7.98	peak	100	12

Note: Measurement Level = Reading Level + Correct Factor



Test Mode :	Mode 22: Full system (HDMI 2 mode 2560*1440@60Hz) Signal from PC for Horizontal (110V/60Hz)		
AC Power :	AC 110V/60Hz	Ant. Polarization:	Vertical
Equipment :	LCD Monitor	Model No :	270LM00043
Temperature :	25°C	Humidity :	52%
Pressure(mbar) :	1001	Date:	2017/05/16

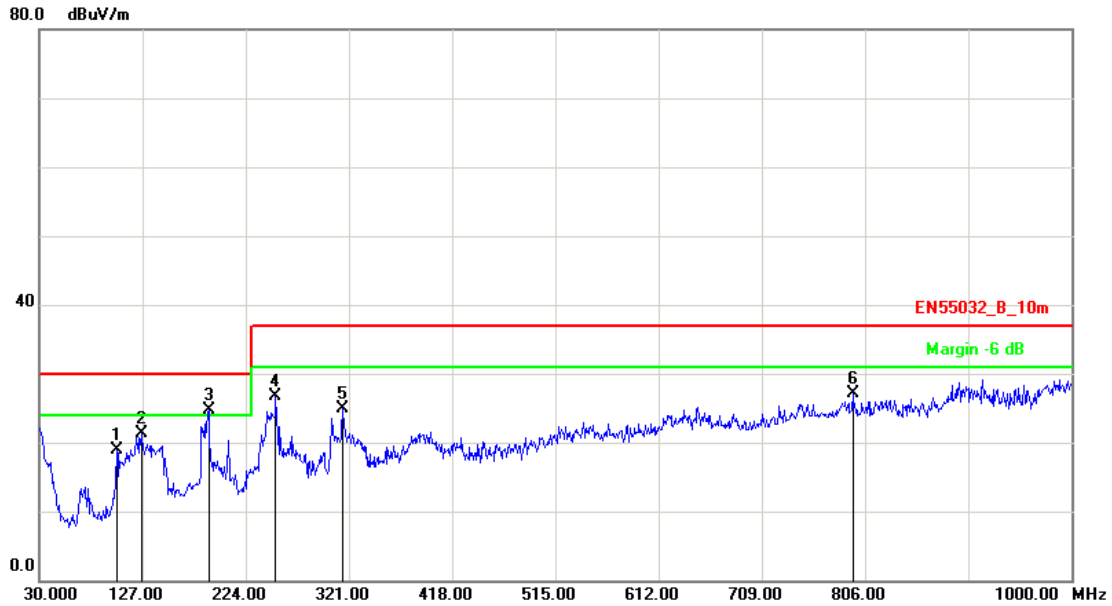

No.	Frequency (MHz)	Factor (dB/m)	Reading (dBuV)	Level (dBuV/m)	Limit (dBuV/m)	Margin (dB)	Det.	Height (cm)	Azimuth (deg)
1	102.7500	-13.22	32.07	18.85	30.00	-11.15	peak	400	125
2	126.0300	-9.81	31.11	21.30	30.00	-8.70	peak	100	126
3	189.0800	-10.77	35.51	24.74	30.00	-5.26	peak	400	3
4	252.1299	-10.36	37.04	26.68	37.00	-10.32	peak	100	155
5	315.1800	-8.20	33.06	24.86	37.00	-12.14	peak	400	222
6	794.3600	1.99	25.07	27.06	37.00	-9.94	peak	100	302

Note: Measurement Level = Reading Level + Correct Factor



5.6. Test Result and Data (1GHz~6GHz)

Test Mode :	Mode 1: Full system (Display mode 2560*1440@60Hz) Signal from PC for Horizontal (230V/50Hz)		
AC Power :	AC 230V/50Hz	Ant. Polarization:	Horizontal
Equipment :	LCD Monitor	Model No :	270LM00043
Temperature :	25°C	Humidity :	52%
Pressure(mbar) :	1001	Date:	2017/05/16

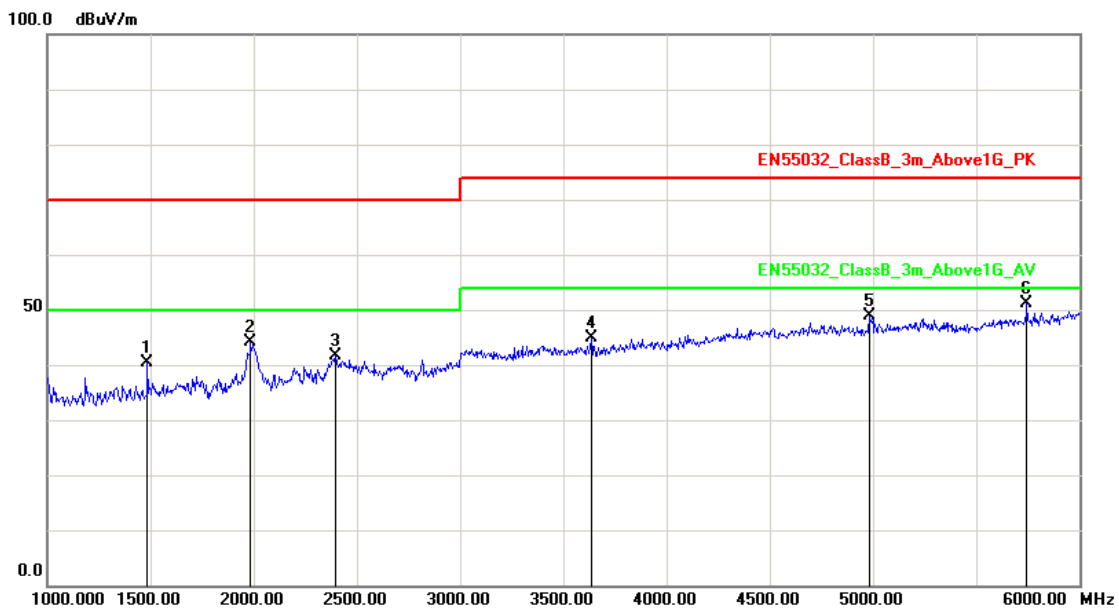

No.	Frequency (MHz)	Factor (dB/m)	Reading (dBuV)	Level (dBuV/m)	Limit (dBuV/m)	Margin (dB)	Det.	Height (cm)	Azimuth (deg)
1	1485.000	-2.74	43.03	40.29	70.00	-29.71	peak	200	124
2	1985.000	-1.24	45.46	44.22	70.00	-25.78	peak	100	58
3	2395.000	0.81	40.75	41.56	70.00	-28.44	peak	100	65
4	3635.000	6.12	38.86	44.98	74.00	-29.02	peak	100	2
5	4985.000	11.09	37.91	49.00	74.00	-25.00	peak	100	225
6	5745.000	13.17	38.03	51.20	74.00	-22.80	peak	100	55

Note: Measurement Level = Reading Level + Correct Factor



Test Mode :	Mode 1: Full system (Display mode 2560*1440@60Hz) Signal from PC for Horizontal (230V/50Hz)		
AC Power :	AC 230V/50Hz	Ant. Polarization:	Vertical
Equipment :	LCD Monitor	Model No :	270LM00043
Temperature :	25°C	Humidity :	52%
Pressure(mbar) :	1001	Date:	2017/05/16

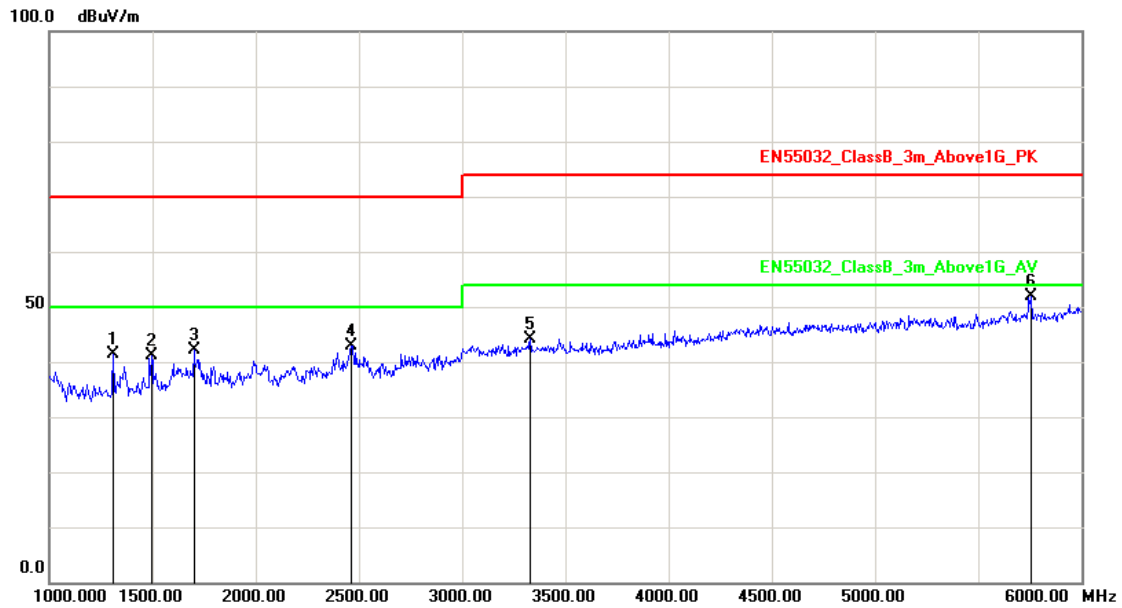

No.	Frequency (MHz)	Factor (dB/m)	Reading (dBuV)	Level (dBuV/m)	Limit (dBuV/m)	Margin (dB)	Det.	Height (cm)	Azimuth (deg)
1	1310.000	-3.91	45.29	41.38	70.00	-28.62	peak	100	148
2	1495.000	-2.67	43.78	41.11	70.00	-28.89	peak	200	57
3	1700.000	-2.06	44.19	42.13	70.00	-27.87	peak	200	52
4	2460.000	1.15	41.72	42.87	70.00	-27.13	peak	100	105
5	3330.000	5.14	38.96	44.10	74.00	-29.90	peak	100	225
6	5755.000	13.22	38.56	51.78	74.00	-22.22	peak	200	305

Note: Measurement Level = Reading Level + Correct Factor



Test Mode :	Mode 5: Full system (VGA mode 1920*1080@60Hz) Signal from PC for Horizontal (230V/50Hz)		
AC Power :	AC 230V/50Hz	Ant. Polarization:	Horizontal
Equipment :	LCD Monitor	Model No :	270LM00043
Temperature :	25°C	Humidity :	52%
Pressure(mbar) :	1001	Date:	2017/05/16

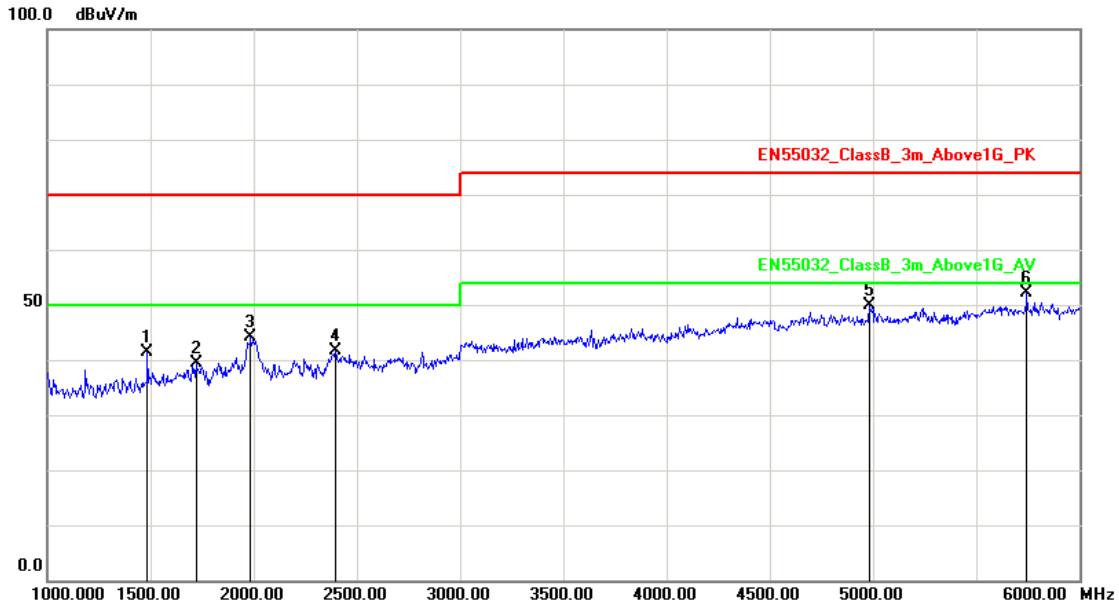

No.	Frequency (MHz)	Factor (dB/m)	Reading (dBuV)	Level (dBuV/m)	Limit (dBuV/m)	Margin (dB)	Det.	Height (cm)	Azimuth (deg)
1	1485.000	-2.74	44.03	41.29	70.00	-28.71	peak	100	214
2	1720.000	-2.01	41.43	39.42	70.00	-30.58	peak	200	157
3	1985.000	-1.24	45.46	44.22	70.00	-25.78	peak	100	125
4	2395.000	0.81	40.75	41.56	70.00	-28.44	peak	100	169
5	4985.000	11.09	38.91	50.00	74.00	-24.00	peak	100	225
6	5745.000	13.17	39.03	52.20	74.00	-21.80	peak	100	155

Note: Measurement Level = Reading Level + Correct Factor



Test Mode :	Mode 5: Full system (VGA mode 1920*1080@60Hz) Signal from PC for Horizontal (230V/50Hz)		
AC Power :	AC 230V/50Hz	Ant. Polarization:	Vertical
Equipment :	LCD Monitor	Model No :	270LM00043
Temperature :	25°C	Humidity :	52%
Pressure(mbar) :	1001	Date:	2017/05/16

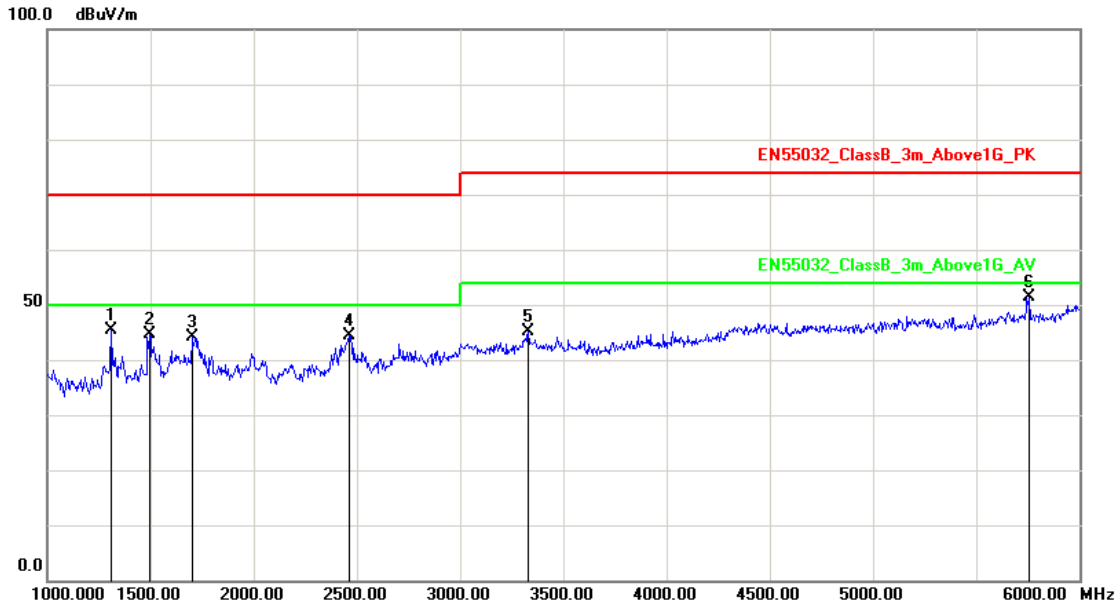

No.	Frequency (MHz)	Factor (dB/m)	Reading (dBuV)	Level (dBuV/m)	Limit (dBuV/m)	Margin (dB)	Det.	Height (cm)	Azimuth (deg)
1	1310.000	-3.91	49.29	45.38	70.00	-24.62	peak	200	127
2	1495.000	-2.67	47.28	44.61	70.00	-25.39	peak	100	149
3	1700.000	-2.06	46.19	44.13	70.00	-25.87	peak	200	302
4	2460.000	1.15	43.22	44.37	70.00	-25.63	peak	200	125
5	3330.000	5.14	39.96	45.10	74.00	-28.90	peak	200	25
6	5755.000	13.22	38.06	51.28	74.00	-22.72	peak	100	169

Note: Measurement Level = Reading Level + Correct Factor



Test Mode :	Mode 9: Full system (HDMI 1 mode 2560*1440@60Hz) Signal from PC for Horizontal (230V/50Hz)		
AC Power :	AC 230V/50Hz	Ant. Polarization:	Horizontal
Equipment :	LCD Monitor	Model No :	270LM00043
Temperature :	25°C	Humidity :	52%
Pressure(mbar) :	1001	Date:	2017/05/16

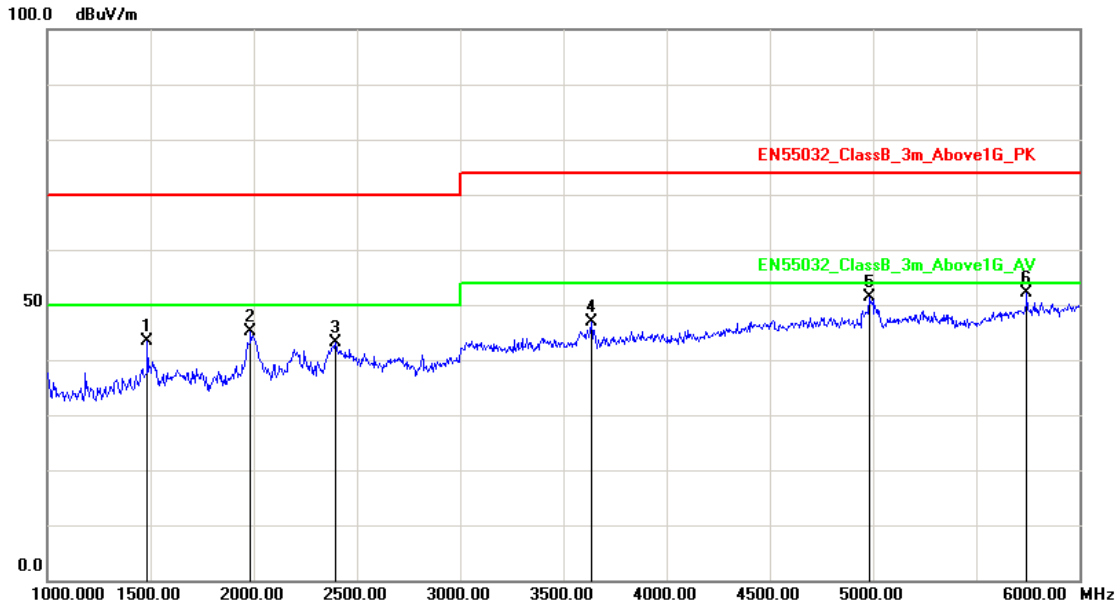

No.	Frequency (MHz)	Factor (dB/m)	Reading (dBuV)	Level (dBuV/m)	Limit (dBuV/m)	Margin (dB)	Det.	Height (cm)	Azimuth (deg)
1	1485.000	-2.74	46.03	43.29	70.00	-26.71	peak	200	124
2	1985.000	-1.24	46.46	45.22	70.00	-24.78	peak	100	157
3	2395.000	0.81	42.25	43.06	70.00	-26.94	peak	100	189
4	3635.000	6.12	40.86	46.98	74.00	-27.02	peak	200	326
5	4985.000	11.09	40.41	51.50	74.00	-22.50	peak	100	12
6	5745.000	13.17	39.03	52.20	74.00	-21.80	peak	100	10

Note: Measurement Level = Reading Level + Correct Factor



Test Mode :	Mode 9: Full system (HDMI 1 mode 2560*1440@60Hz) Signal from PC for Horizontal (230V/50Hz)		
AC Power :	AC 230V/50Hz	Ant. Polarization:	Vertical
Equipment :	LCD Monitor	Model No :	270LM00043
Temperature :	25°C	Humidity :	52%
Pressure(mbar) :	1001	Date:	2017/05/16

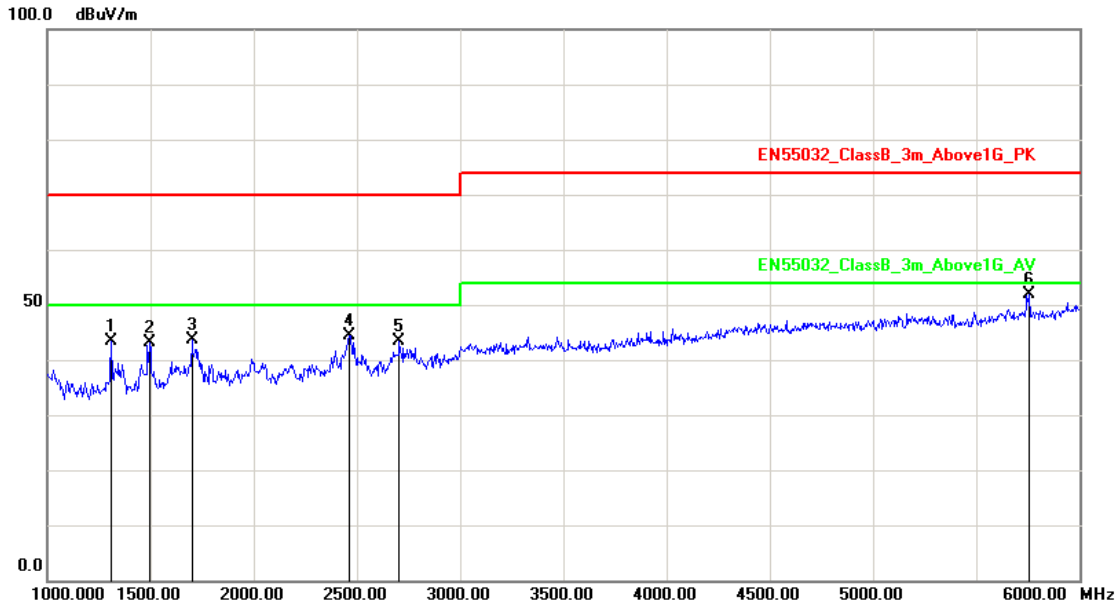

No.	Frequency (MHz)	Factor (dB/m)	Reading (dBuV)	Level (dBuV/m)	Limit (dBuV/m)	Margin (dB)	Det.	Height (cm)	Azimuth (deg)
1	1310.000	-3.91	47.29	43.38	70.00	-26.62	peak	200	214
2	1495.000	-2.67	45.78	43.11	70.00	-26.89	peak	100	178
3	1700.000	-2.06	45.69	43.63	70.00	-26.37	peak	200	45
4	2460.000	1.15	43.22	44.37	70.00	-25.63	peak	200	298
5	2705.000	2.49	40.83	43.32	70.00	-26.68	peak	100	63
6	5755.000	13.22	38.56	51.78	74.00	-22.22	peak	200	2

Note: Measurement Level = Reading Level + Correct Factor



Test Mode :	Mode 14: Full system (HDMI 2 mode 2560*1440@60Hz) Signal from PC for Horizontal (230V/50Hz)		
AC Power :	AC 230V/50Hz	Ant. Polarization:	Horizontal
Equipment :	LCD Monitor	Model No :	270LM00043
Temperature :	25°C	Humidity :	52%
Pressure(mbar) :	1001	Date:	2017/05/16

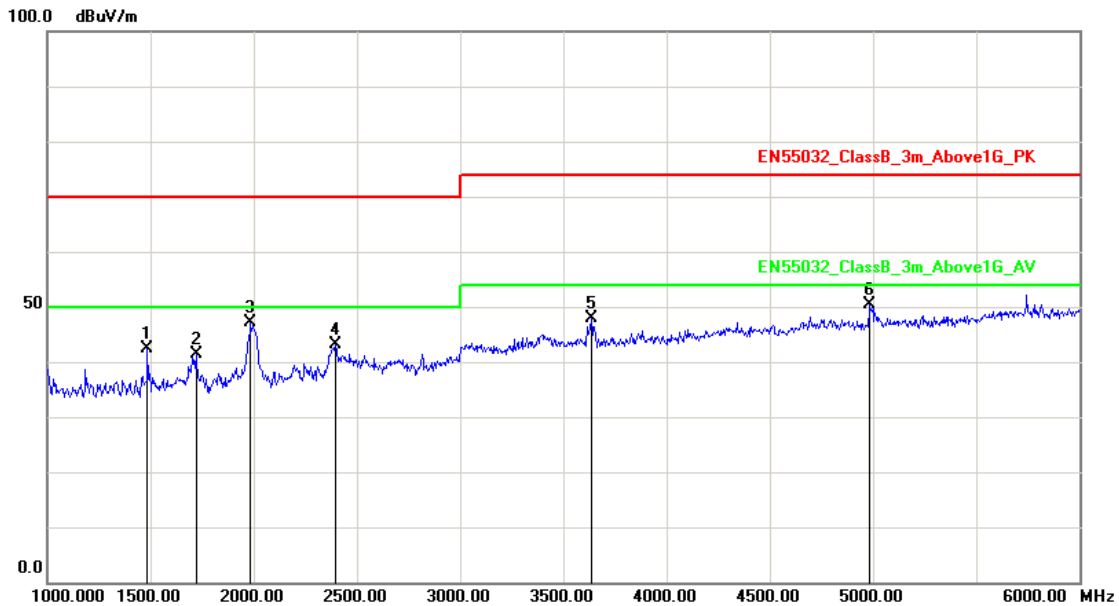

No.	Frequency (MHz)	Factor (dB/m)	Reading (dBuV)	Level (dBuV/m)	Limit (dBuV/m)	Margin (dB)	Det.	Height (cm)	Azimuth (deg)
1	1485.000	-2.74	45.03	42.29	70.00	-27.71	peak	100	214
2	1720.000	-2.01	43.43	41.42	70.00	-28.58	peak	200	157
3	1985.000	-1.24	48.46	47.22	70.00	-22.78	peak	100	68
4	2395.000	0.81	42.25	43.06	70.00	-26.94	peak	200	325
5	3635.000	6.12	41.86	47.98	74.00	-26.02	peak	100	124
6	4985.000	11.09	39.41	50.50	74.00	-23.50	peak	100	122

Note: Measurement Level = Reading Level + Correct Factor



Test Mode :	Mode 14: Full system (HDMI 2 mode 2560*1440@60Hz) Signal from PC for Horizontal (230V/50Hz)		
AC Power :	AC 230V/50Hz	Ant. Polarization:	Vertical
Equipment :	LCD Monitor	Model No :	270LM00043
Temperature :	25°C	Humidity :	52%
Pressure(mbar) :	1001	Date:	2017/05/16

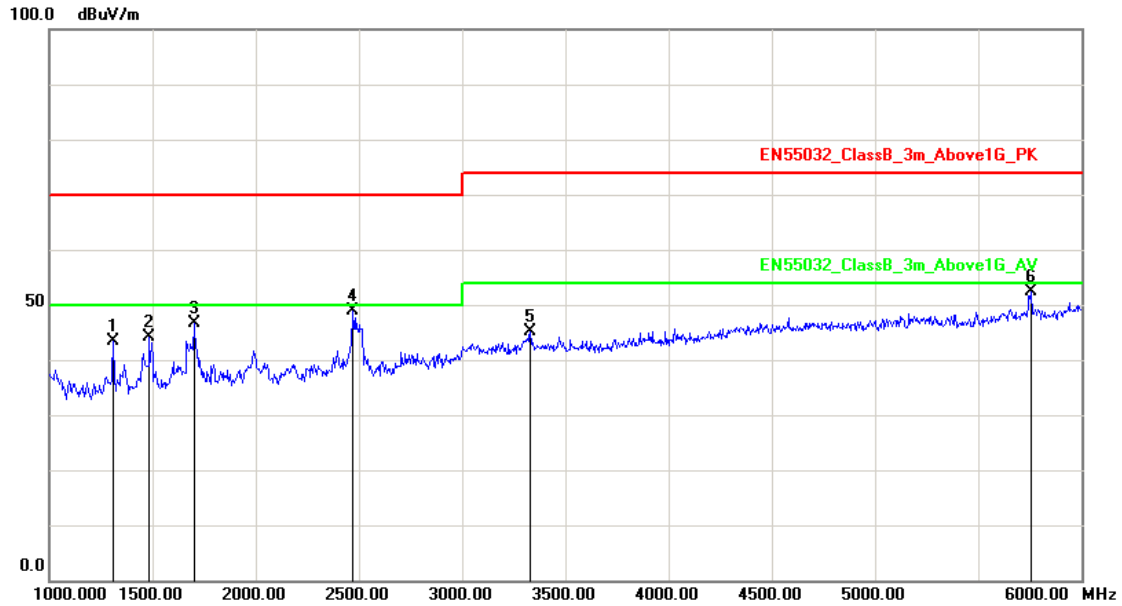

No.	Frequency (MHz)	Factor (dB/m)	Reading (dBuV)	Level (dBuV/m)	Limit (dBuV/m)	Margin (dB)	Det.	Height (cm)	Azimuth (deg)
1	1310.000	-3.91	47.29	43.38	70.00	-26.62	peak	200	187
2	1485.000	-2.74	46.78	44.04	70.00	-25.96	peak	200	196
3	1700.000	-2.06	48.69	46.63	70.00	-23.37	peak	200	235
4	2470.000	1.20	47.58	48.78	70.00	-21.22	peak	100	12
5	3330.000	5.14	39.96	45.10	74.00	-28.90	peak	100	225
6	5755.000	13.22	39.06	52.28	74.00	-21.72	peak	200	127

Note: Measurement Level = Reading Level + Correct Factor



Test Mode :	Mode 19: Full system (Display mode 2560*1440@60Hz) Signal from PC for Horizontal (110V/60Hz)		
AC Power :	AC 230V/50Hz	Ant. Polarization:	Horizontal
Equipment :	LCD Monitor	Model No :	270LM00043
Temperature :	25°C	Humidity :	52%
Pressure(mbar) :	1001	Date:	2017/05/16

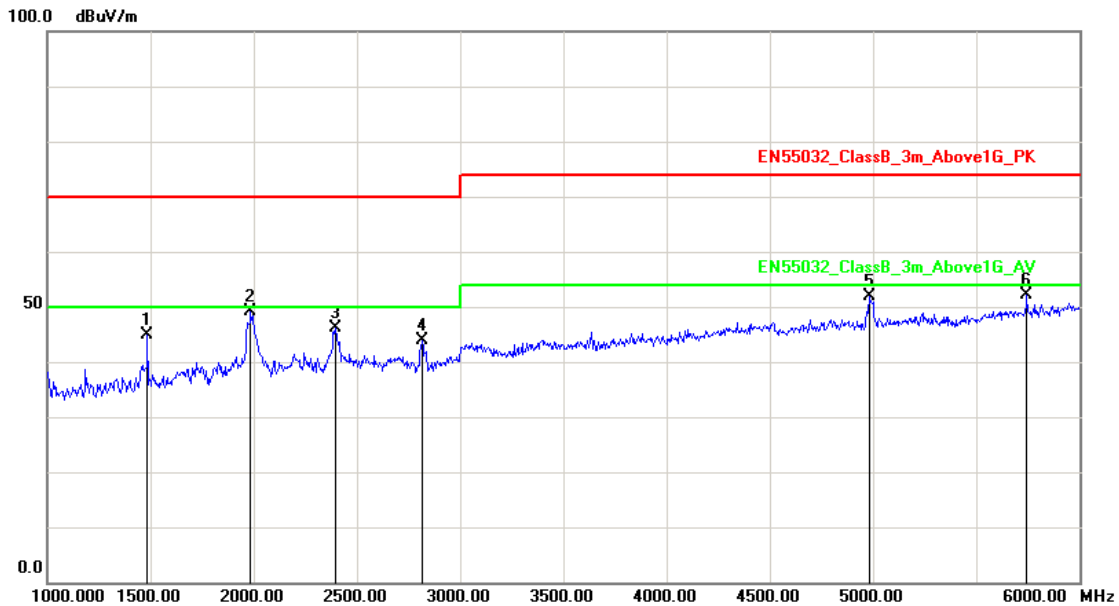

No.	Frequency (MHz)	Factor (dB/m)	Reading (dBuV)	Level (dBuV/m)	Limit (dBuV/m)	Margin (dB)	Det.	Height (cm)	Azimuth (deg)
1	1485.000	-2.74	47.53	44.79	70.00	-25.21	peak	200	144
2	1985.000	-1.24	50.46	49.22	70.00	-20.78	peak	100	215
3	2395.000	0.81	45.25	46.06	70.00	-23.94	peak	200	22
4	2815.000	3.10	40.87	43.97	70.00	-26.03	peak	200	35
5	4985.000	11.09	40.91	52.00	74.00	-22.00	peak	200	12
6	5745.000	13.17	39.03	52.20	74.00	-21.80	peak	100	126

Note: Measurement Level = Reading Level + Correct Factor



Test Mode :	Mode 19: Full system (Display mode 2560*1440@60Hz) Signal from PC for Horizontal (110V/60Hz)		
AC Power :	AC 110V/60Hz	Ant. Polarization:	Vertical
Equipment :	LCD Monitor	Model No :	270LM00043
Temperature :	25°C	Humidity :	52%
Pressure(mbar) :	1001	Date:	2017/05/16

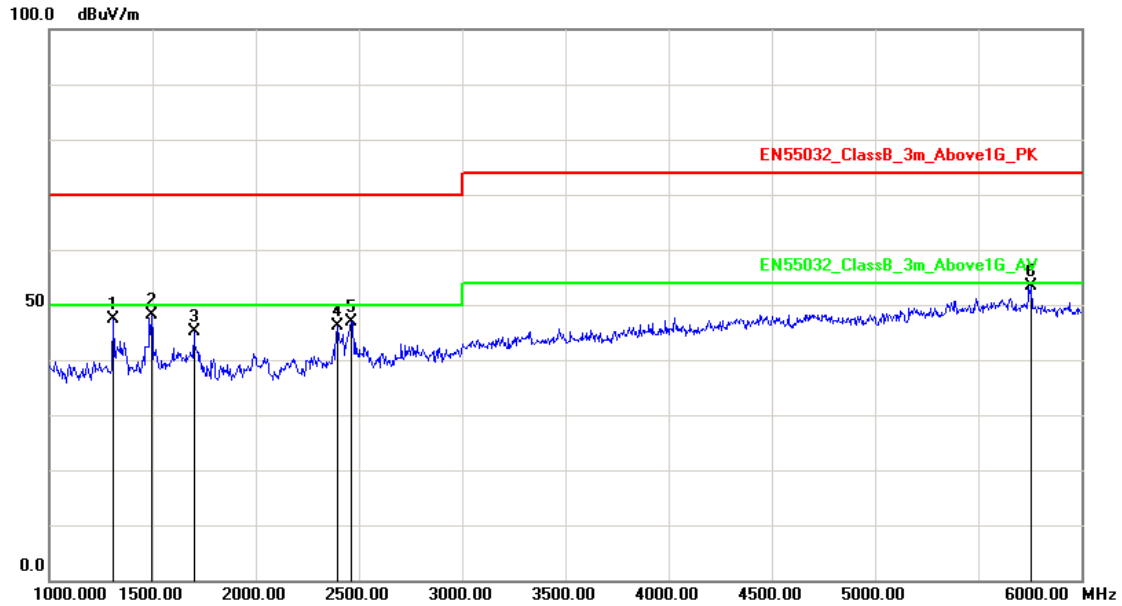

No.	Frequency (MHz)	Factor (dB/m)	Reading (dBuV)	Level (dBuV/m)	Limit (dBuV/m)	Margin (dB)	Det.	Height (cm)	Azimuth (deg)
1	1310.000	-3.91	51.29	47.38	70.00	-22.62	peak	100	114
2	1495.000	-2.67	50.78	48.11	70.00	-21.89	peak	200	215
3	1700.000	-2.06	47.19	45.13	70.00	-24.87	peak	100	12
4	2395.000	0.81	45.25	46.06	70.00	-23.94	peak	100	45
5	2460.000	1.15	45.72	46.87	70.00	-23.13	peak	100	122
6	5755.000	13.22	40.06	53.28	74.00	-20.72	peak	200	201

Note: Measurement Level = Reading Level + Correct Factor



Test Mode :	Mode 20: Full system (VGA mode 1920*1080@60Hz) Signal from PC for Horizontal (110V/60Hz)		
AC Power :	AC 110V/60Hz	Ant. Polarization:	Horizontal
Equipment :	LCD Monitor	Model No :	270LM00043
Temperature :	25°C	Humidity :	52%
Pressure(mbar) :	1001	Date:	2017/05/16

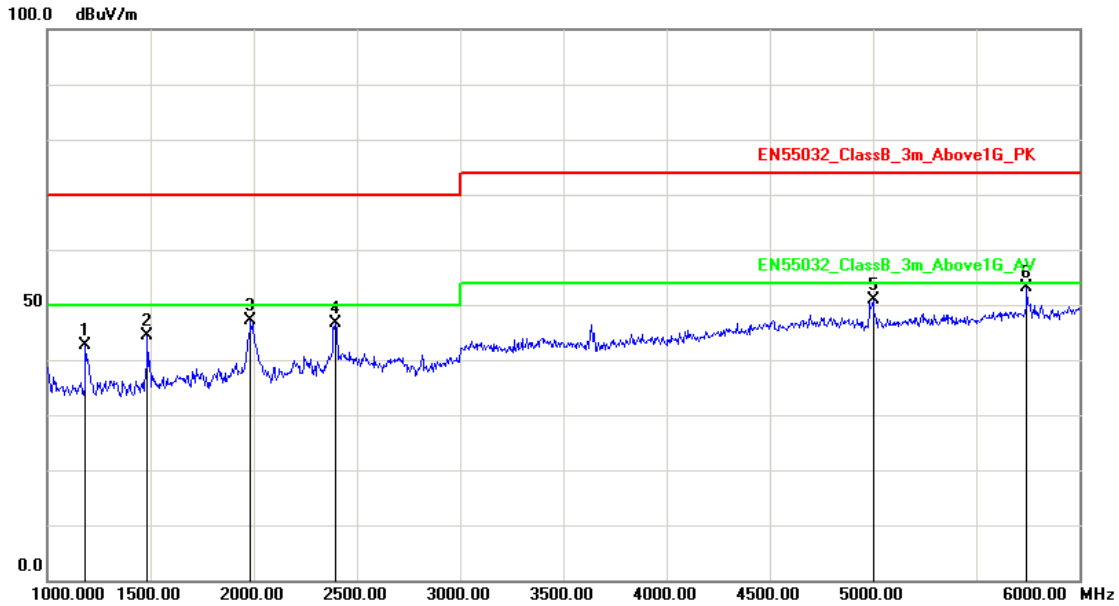

No.	Frequency (MHz)	Factor (dB/m)	Reading (dBuV)	Level (dBuV/m)	Limit (dBuV/m)	Margin (dB)	Det.	Height (cm)	Azimuth (deg)
1	1185.000	-4.74	47.46	42.72	70.00	-27.28	peak	200	12
2	1485.000	-2.74	47.03	44.29	70.00	-25.71	peak	100	112
3	1985.000	-1.24	48.46	47.22	70.00	-22.78	peak	100	125
4	2395.000	0.81	45.75	46.56	70.00	-23.44	peak	100	22
5	5000.000	11.12	39.68	50.80	74.00	-23.20	peak	200	145
6	5745.000	13.17	40.03	53.20	74.00	-20.80	peak	100	302

Note: Measurement Level = Reading Level + Correct Factor



Test Mode :	Mode 20: Full system (VGA mode 1920*1080@60Hz) Signal from PC for Horizontal (110V/60Hz)		
AC Power :	AC 110V/60Hz	Ant. Polarization:	Vertical
Equipment :	LCD Monitor	Model No :	270LM00043
Temperature :	25°C	Humidity :	52%
Pressure(mbar) :	1001	Date:	2017/05/16

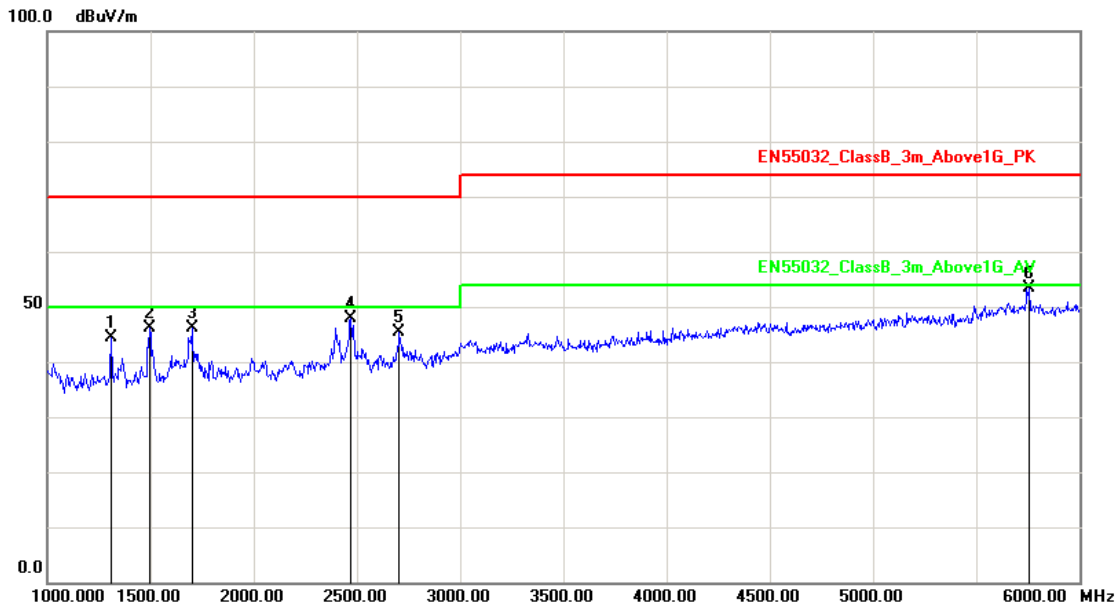

No.	Frequency (MHz)	Factor (dB/m)	Reading (dBuV)	Level (dBuV/m)	Limit (dBuV/m)	Margin (dB)	Det.	Height (cm)	Azimuth (deg)
1	1310.000	-3.91	48.29	44.38	70.00	-25.62	peak	200	124
2	1495.000	-2.67	48.78	46.11	70.00	-23.89	peak	100	155
3	1700.000	-2.06	48.19	46.13	70.00	-23.87	peak	200	25
4	2470.000	1.20	46.58	47.78	70.00	-22.22	peak	100	265
5	2705.000	2.49	42.83	45.32	70.00	-24.68	peak	100	123
6	5755.000	13.22	40.06	53.28	74.00	-20.72	peak	200	120

Note: Measurement Level = Reading Level + Correct Factor



Test Mode :	Mode 21: Full system (HDMI 1 mode 2560*1440@60Hz) Signal from PC for Horizontal (110V/60Hz)		
AC Power :	AC 110V/60Hz	Ant. Polarization:	Horizontal
Equipment :	LCD Monitor	Model No :	270LM00043
Temperature :	25°C	Humidity :	52%
Pressure(mbar) :	1001	Date:	2017/05/16

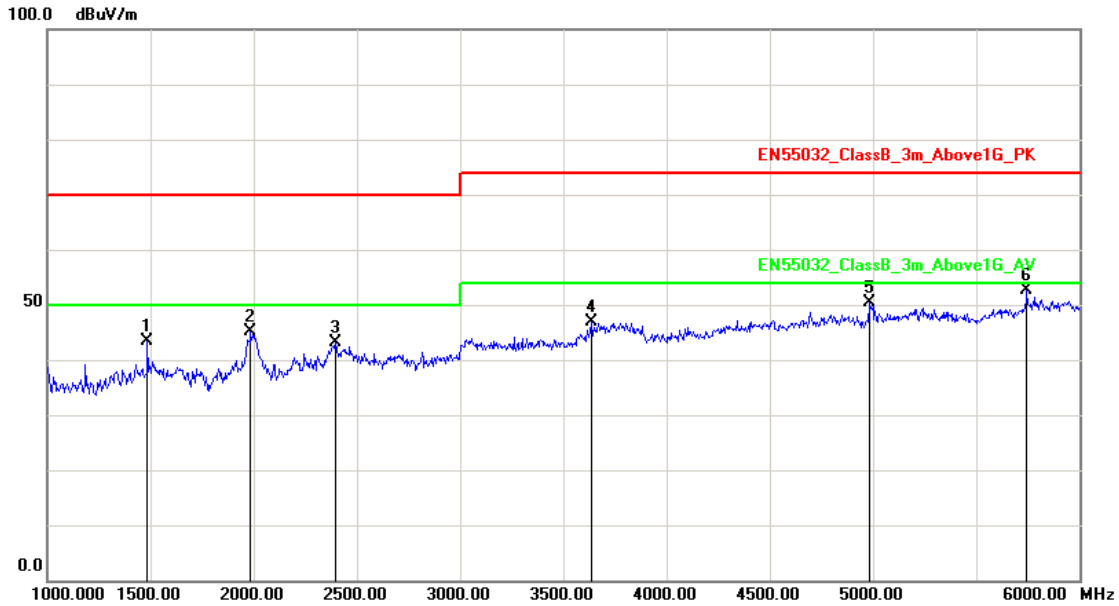

No.	Frequency (MHz)	Factor (dB/m)	Reading (dBuV)	Level (dBuV/m)	Limit (dBuV/m)	Margin (dB)	Det.	Height (cm)	Azimuth (deg)
1	1485.000	-2.74	46.03	43.29	70.00	-26.71	peak	200	214
2	1985.000	-1.24	46.46	45.22	70.00	-24.78	peak	100	55
3	2395.000	0.81	42.25	43.06	70.00	-26.94	peak	100	125
4	3635.000	6.12	40.86	46.98	74.00	-27.02	peak	200	302
5	4985.000	11.09	39.41	50.50	74.00	-23.50	peak	100	155
6	5745.000	13.17	39.53	52.70	74.00	-21.30	peak	100	25

Note: Measurement Level = Reading Level + Correct Factor



Test Mode :	Mode 21: Full system (HDMI 1 mode 2560*1440@60Hz) Signal from PC for Horizontal (110V/60Hz)		
AC Power :	AC 110V/60Hz	Ant. Polarization:	Vertical
Equipment :	LCD Monitor	Model No :	270LM00043
Temperature :	25°C	Humidity :	52%
Pressure(mbar) :	1001	Date:	2017/05/16

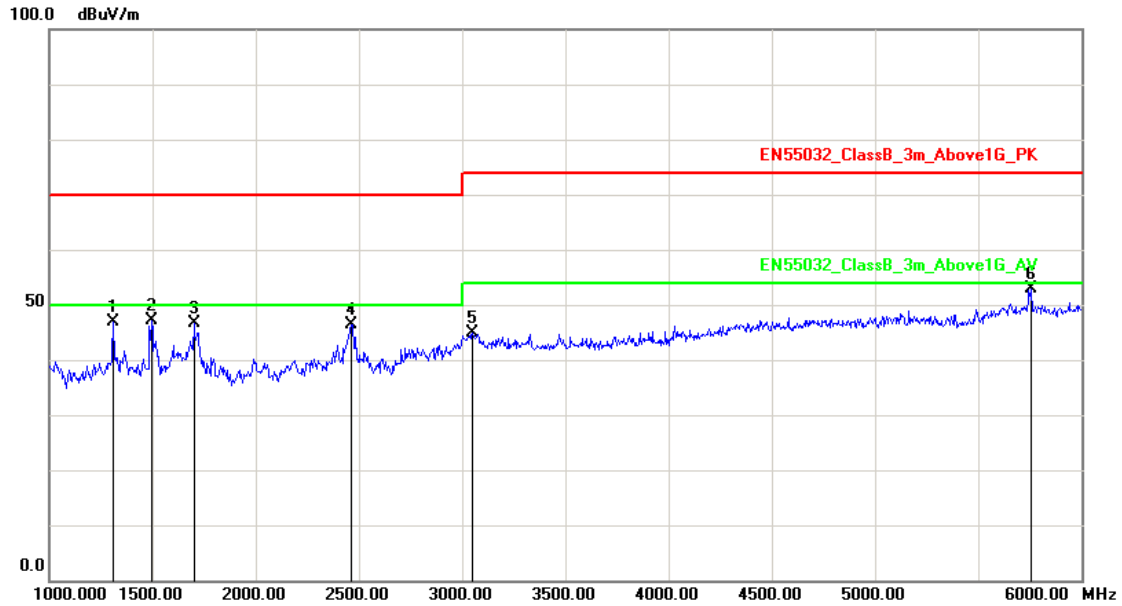

No.	Frequency (MHz)	Factor (dB/m)	Reading (dBuV)	Level (dBuV/m)	Limit (dBuV/m)	Margin (dB)	Det.	Height (cm)	Azimuth (deg)
1	1310.000	-3.91	50.79	46.88	70.00	-23.12	peak	200	124
2	1495.000	-2.67	49.78	47.11	70.00	-22.89	peak	100	155
3	1700.000	-2.06	48.69	46.63	70.00	-23.37	peak	100	256
4	2460.000	1.15	45.22	46.37	70.00	-23.63	peak	200	223
5	3050.000	4.27	40.49	44.76	74.00	-29.24	peak	100	12
6	5755.000	13.22	39.56	52.78	74.00	-21.22	peak	100	0

Note: Measurement Level = Reading Level + Correct Factor



Test Mode :	Mode 22: Full system (HDMI 2 mode 2560*1440@60Hz) Signal from PC for Horizontal (110V/60Hz)		
AC Power :	AC 110V/60Hz	Ant. Polarization:	Horizontal
Equipment :	LCD Monitor	Model No :	270LM00043
Temperature :	25°C	Humidity :	52%
Pressure(mbar) :	1001	Date:	2017/05/16

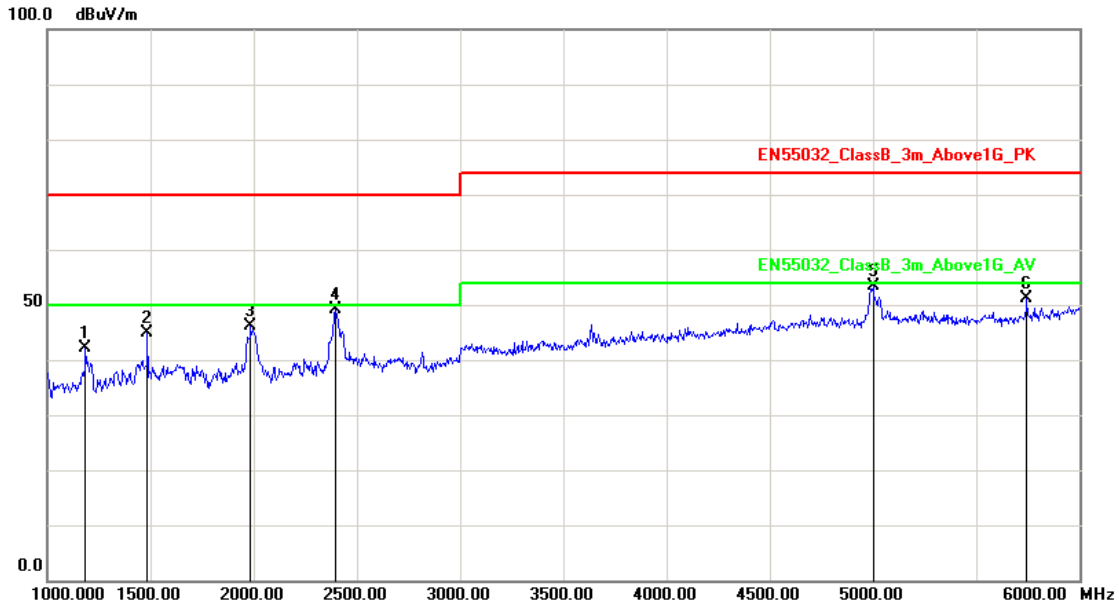

No.	Frequency (MHz)	Factor (dB/m)	Reading (dBuV)	Level (dBuV/m)	Limit (dBuV/m)	Margin (dB)	Det.	Height (cm)	Azimuth (deg)
1	1185.000	-4.74	46.96	42.22	70.00	-27.78	peak	100	215
2	1485.000	-2.74	47.53	44.79	70.00	-25.21	peak	100	125
3	1985.000	-1.24	47.46	46.22	70.00	-23.78	peak	200	266
4	2395.000	0.81	48.25	49.06	70.00	-20.94	peak	100	30
5	5000.000	11.12	42.18	53.30	74.00	-20.70	peak	100	125
6	5745.000	13.17	38.03	51.20	74.00	-22.80	peak	200	0

Note: Measurement Level = Reading Level + Correct Factor



Test Mode :	Mode 22: Full system (HDMI 2 mode 2560*1440@60Hz) Signal from PC for Horizontal (110V/60Hz)		
AC Power :	AC 110V/60Hz	Ant. Polarization:	Vertical
Equipment :	LCD Monitor	Model No :	270LM00043
Temperature :	25°C	Humidity :	52%
Pressure(mbar) :	1001	Date:	2017/05/16

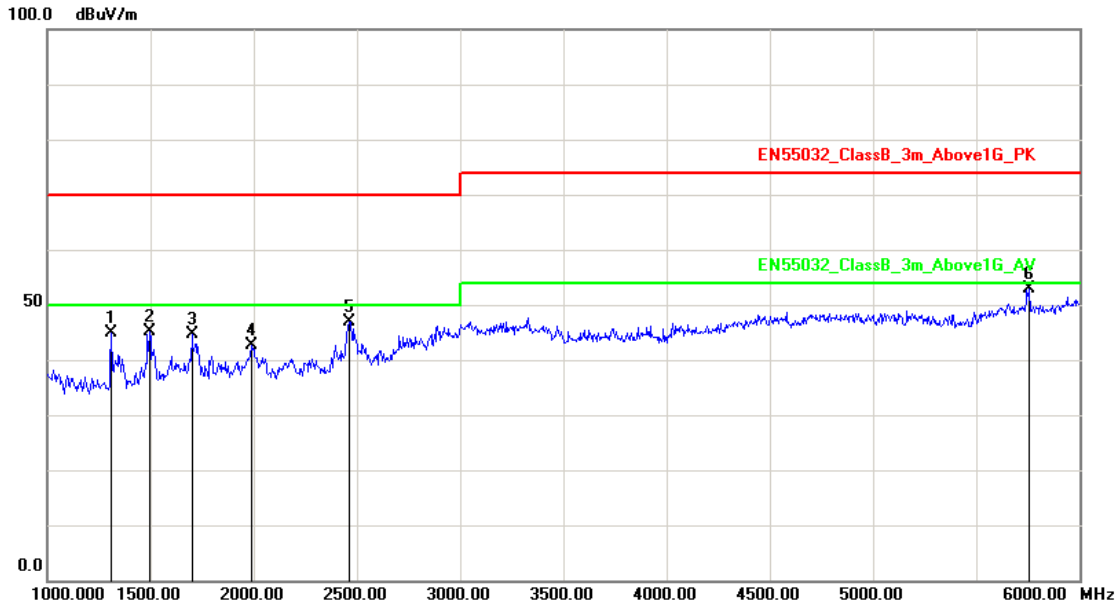

No.	Frequency (MHz)	Factor (dB/m)	Reading (dBuV)	Level (dBuV/m)	Limit (dBuV/m)	Margin (dB)	Det.	Height (cm)	Azimuth (deg)
1	1310.000	-3.91	48.79	44.88	70.00	-25.12	peak	200	124
2	1495.000	-2.67	47.78	45.11	70.00	-24.89	peak	100	15
3	1700.000	-2.06	46.69	44.63	70.00	-25.37	peak	200	26
4	1990.000	-1.23	43.98	42.75	70.00	-27.25	peak	100	302
5	2460.000	1.15	45.72	46.87	70.00	-23.13	peak	200	126
6	5755.000	13.22	39.56	52.78	74.00	-21.22	peak	100	356

Note: Measurement Level = Reading Level + Correct Factor

Test engineer: Sun. Zhang



5.7. Test Photographs (30MHz~1GHz)

Front View



Rear View

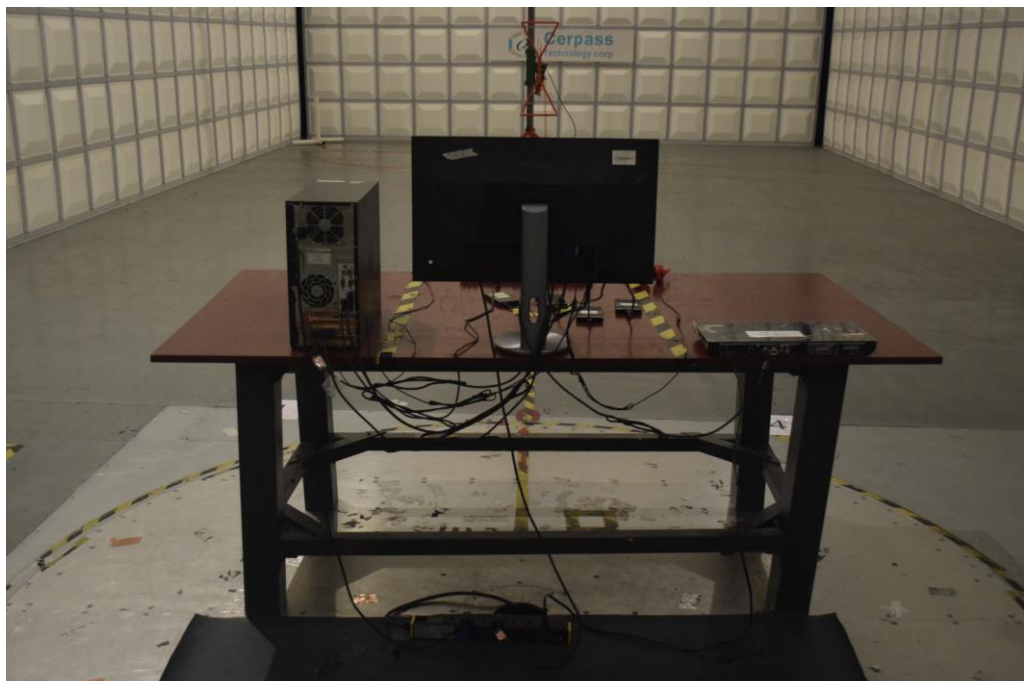



5.8. Test Photographs (1GHz~6GHz)

Front View



Rear View

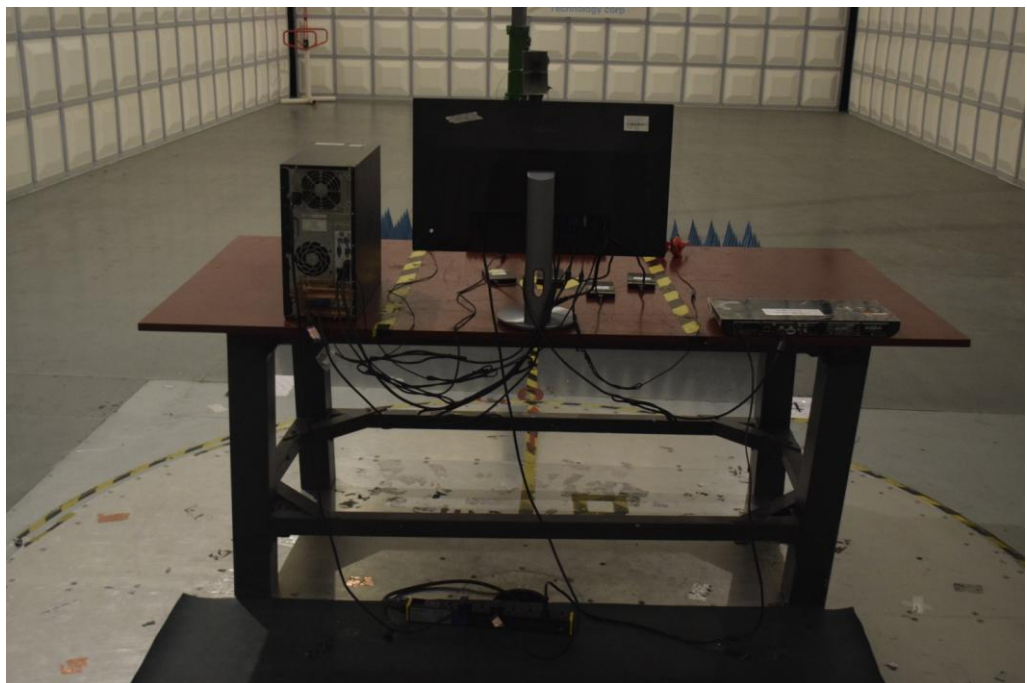



6. Harmonics Test

6.1. Limits of Harmonics Current Measurement

Limits for Class A equipment

Harmonics Order n	Max. permissible harmonics current A	Harmonics Order n	Max. permissible harmonics current A
Odd harmonics		Even harmonics	
3	2.30	2	1.08
5	1.14	4	0.43
7	0.77	6	0.30
9	0.40	8 ≤ n ≤ 40	0.23x8/n
11	0.33		
13	0.21		
15 ≤ n ≤ 39	0.15x15/n		

(b) Limits for Class B equipment

For Class B equipment, the harmonics of the input current shall not exceed the values given in Table that is the limit of Class A multiplied by a factor of 1,5.

(c) Limits for Class C equipment

Harmonics Order n	Maximum permissible harmonic current expressed as a percentage of the input current at the fundamental frequency %
2	2
3	$30 \cdot \lambda^*$
5	10
7	7
9	5
11 < n < 39 (odd harmonics only)	3

* λ is the circuit power factor

(d) Limits for Class D equipment

Harmonics Order n	Maximum permissible harmonic current per watt mA/W	Maximum permissible harmonic current A
3	3.4	2.30
5	1.9	1.14
7	1.0	0.77
9	0.5	0.40
11	0.35	0.33
11 < n < 39 (odd harmonics only)	3.85/n	See limit of Class A

NOTE: According to section 7 of EN 61000-3-2, the above limits for all equipment except for lighting equipment having an active input power > 75 W and no limits apply for equipment with an active input power up to and including 75 W.



6.2. Measurement Equipment

Instrument/Ancillary	Manufacturer	Model No.	Serial No.	Calibration Date	Valid Date.
EMC Emission Tester	EMCPARTNER	Harmonics-1000	159	2017.03.28	2018.03.27
Temperature/ Humidity Meter	Zhicheng	ZC1-11	CEP-TH-004	2017.03.28	2018.03.27
HARCS	EMC Partner AG	Ver 4.18	N/A	N/A	N/A



6.3. Test Result and Data

Basic Standard	:	EN 61000-3-2
Final Test Result	:	PASS
Test Mode	:	Mode 1,5,9,14
Model No.	:	270LM00043
Temperature	:	24°C
Humidity	:	53 %
Atmospheric Pressure	:	100 kPa
Test Date	:	May 16, 2017

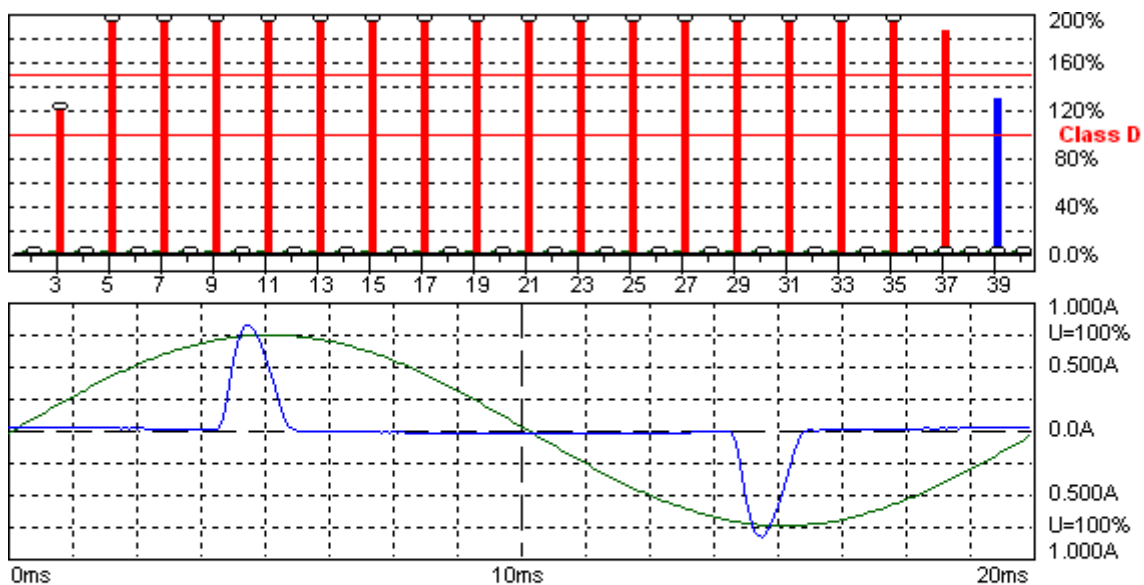

Harmonic Emission - IEC 61000-3-2 , EN 61000-3-2 , (EN60555-2)

2017-5-16 13:31:16 harmonic.hsu

Urms = 229.9 V	P = 21.33 W	THC = 0.187 A	Range: 1 A
Irms = 0.206 A	pf = 0.451	Pmax = 22.03 W	V-nom: 230 V
			TestTime: 15 min (100%)

HAR-1000 EMC-Partner

Urms = 229.9V Freq = 50.013 Range: 1 A
 Irms = 0.206A Ipk = 0.834A cf = 4.057
 P = 21.33W S = 47.26VA pf = 0.451
 THDi = 89.0 % THDu = 0.20 % Class D
 Test - Time : 15min (100 %)
 Limit Reference: Pmax = 22.028W
 Test completed



Order	Freq. [Hz]	Irms [A]	Irms%L [%]	I _{max} [A]	I _{max} %L [%]	Limit [A]	Status
1	50	0.0962		0.0963			
2	100	0.0002		0.0009			
3	150	0.0900	120.20	0.0901	120.28	0.00	N/L
4	200	0.0004		0.0009			
5	250	0.0851	203.43	0.0852	203.58	0.00	N/L
6	300	0.0004		0.0009			
7	350	0.0780	354.10	0.0780	354.10	0.00	N/L
8	400	0.0005		0.0009			
9	450	0.0691	627.30	0.0691	627.30	0.00	N/L
10	500	0.0005		0.0009			
11	550	0.0588	763.15	0.0588	763.15	0.00	N/L
12	600	0.0005		0.0009			
13	650	0.0482	738.17	0.0482	738.17	0.00	N/L
14	700	0.0005		0.0008			
15	750	0.0375	662.82	0.0375	662.82	0.00	N/L
16	800	0.0004		0.0007			
17	850	0.0275	550.55	0.0275	551.78	0.00	N/L
18	900	0.0004		0.0005			
19	950	0.0188	421.16	0.0189	422.52	0.00	N/L
20	1000	0.0002		0.0004			
21	1050	0.0121	300.75	0.0122	302.26	0.00	N/L
22	1100	0.0002		0.0003			
23	1150	0.0085	230.08	0.0085	230.08	0.00	N/L
24	1200	0.0002		0.0002			
25	1250	0.0079	232.10	0.0079	232.10	0.00	N/L
26	1300	0.0002		0.0003			
27	1350	0.0086	273.98	0.0087	277.87	0.00	N/L
28	1400	0.0002		0.0004			
29	1450	0.0090	308.89	0.0091	310.97	0.00	N/L
30	1500	0.0002		0.0004			
31	1550	0.0086	314.57	0.0087	316.80	0.00	N/L
32	1600	0.0002		0.0004			
33	1650	0.0075	292.12	0.0076	294.49	0.00	N/L
34	1700	0.0002		0.0003			
35	1750	0.0059	244.33	0.0060	246.85	0.00	N/L
36	1800	0.0002		0.0003			
37	1850	0.0043	186.40	0.0043	186.40	0.00	N/L
38	1900	0.0002		0.0002			
39	1950	0.0028	129.11	0.0028	129.11	0.00	N/L
40	2000	0.0002		0.0002			

The power of EUT is less than 75W after the testing. According the standard, the equipment with a rated power of 75W or less, other than lighting equipment, limits are not specified in this standard. So the test data needn't list.

Test engineer: Sun. Zhang



6.4. Test Photographs





7. Voltage Fluctuations Test

7.1. Test Procedure

The equipment shall be tested under the conditions of **Clause 5**.

The total impedance of the test circuit, excluding the appliance under test, but including the internal impedance of the supply source, shall be equal to the reference impedance.

The stability and tolerance of the reference impedance shall be adequate to ensure that the overall accuracy of $\pm 8\%$ is achieved during the whole assessment procedure.

7.2. Measurement Equipment

Instrument/Ancillary	Manufacturer	Model No.	Serial No.	Calibration Date	Valid Date.
EMC Emission Tester	EMCPARTNER	Harmonics-1000	159	2017.03.28	2018.03.27
Temperature/ Humidity Meter	Zhicheng	ZC1-11	CEP-TH-004	2017.03.28	2018.03.27
HARCS	EMC Partner AG	Ver 4.18	N/A	N/A	N/A



7.3. Test Result and Data

Basic Standard	:	EN 61000-3-3
Final Test Result	:	PASS
Test Mode	:	Mode 1,5,9,14
Model No.	:	270LM00043
Temperature	:	24°C
Humidity	:	53 %
Atmospheric Pressure	:	100 kPa
Test Date	:	May 16, 2017

Flickermeter 1000-4-15 for 230V/50Hz

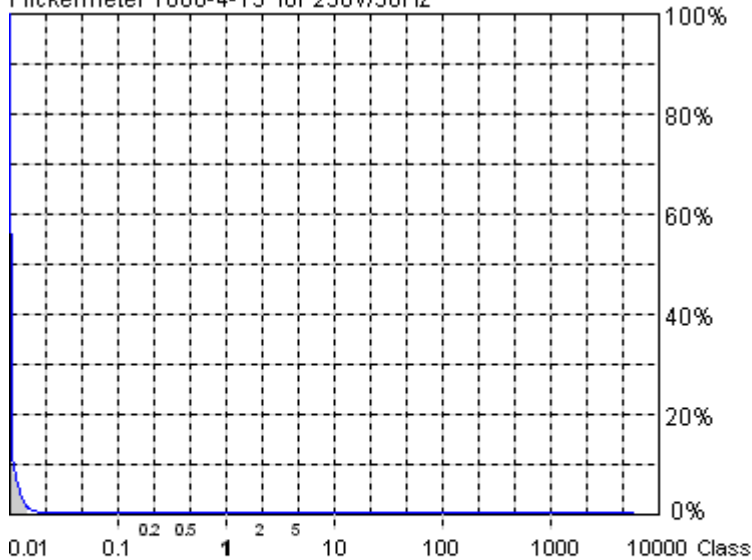

Actual Flicker (Fli):	0.01
Short-term Flicker (Pst):	0.08
Limit (Pst):	1.00
Long-term Flicker (Plt):	0.08
Limit (Plt):	0.65
Maximum Relative Volt. Change (dmax):	0.00%
Limit (dmax):	4.00%
Relative Steady-state Voltage Change (dc):	0.08%
Limit (dc):	3.30%
Maximum Interval exceeding 3.30% (dt):	0.00ms
Limit (dt>Lim):	500ms

Flicker Emission - IEC 61000-3-3 , EN 61000-3-3 , (EN60555-3)

2017-5-16 13:19:26 harmonic.hsu

Urms = 229.9 V P = 21.35 W
 Irms = 0.203 A pf = 0.457

Range: 1 A
 V-nom: 230 V
 TestTime: 10 min (100%)

Test completed, Result: PASSED

HAR-1000 EMC-Parber

- Full Bar : Actual Values
- Empty Bar : Maximum Values
- Circles : Average Values
- Blue : Current , Green : Voltage , Red : Failed



Urms = 229.9V Freq = 50.013 Range: 1 A
Irms = 0.203A Ipk = 0.813A cf = 4.000
P = 21.35W S = 46.70VA pf = 0.457

Test - Time : 1 x 10min = 10min (100 %)

LIN (Line Impedance Network) : No LIN

Limits : Plt : 0.65 Pst : 1.00
dmax : 4.00 % dc : 3.30 %
dtLim: 3.30 % dt>Lim: 500ms

Test completed, Result: PASSED

Test engineer: Sun. Zhang



7.4. Test Photographs





8. Electrostatic Discharge Immunity Test

8.1. Test Procedure

- a. In the case of air discharge testing the climatic conditions shall be within the following ranges:
 - ambient temperature: 15°C to 35°C;
 - relative humidity : 30% to 60%;
 - atmospheric pressure : 86 KPa (860 mbar) to 106 KPa (1060 mbar).
- b. Test programs and software shall be chosen so as to exercise all normal modes of operation of the EUT. The use of special exercising software is encouraged, but permitted only where it can be shown that the EUT is being comprehensively exercised.
- c. The test voltage shall be increased from the minimum to the selected test severity level, in order to determine any threshold of failure. The final severity level should not exceed the product specification value in order to avoid damage to the equipment.
- d. The test shall be performed with both air discharge and contact discharge. On reselected points at least 10 single discharges (in the most sensitive polarity) shall be applied on air discharge. On reselected points at least 25 single discharges (in the most sensitive polarity) shall be applied on contact discharge.
- e. For the time interval between successive single discharges an initial value of one second is recommended. Longer intervals may be necessary to determine whether a system failure has occurred.
- f. In the case of contact discharges, the tip of the discharge electrode shall touch the EUT before the discharge switch is operated.
- g. In the case of painted surface covering a conducting substrate, the following procedure shall be adopted :
 - If the coating is not declared to be an insulating coating by the equipment manufacturer, then the pointed tip of the generator shall penetrate the coating so as to make contact with the conducting substrate.
 - Coating declared as insulating by the manufacturer shall only be submitted to the air discharge.
 - The contact discharge test shall not be applied to such surfaces.
- h. In the case of air discharges, the round discharge tip of the discharge electrode shall be approached as fast as possible (without causing mechanical damage) to touch the EUT . After each discharge, the ESD generator (discharge electrode) shall be removed from the EUT. The generator is then retriggered for a new single discharge. This procedure shall be repeated until the discharges are completed. In the case of an air discharge test, the discharge switch, which is used for contact discharge, shall be closed.

8.2. Test Setup for Tests Performed in Laboratory

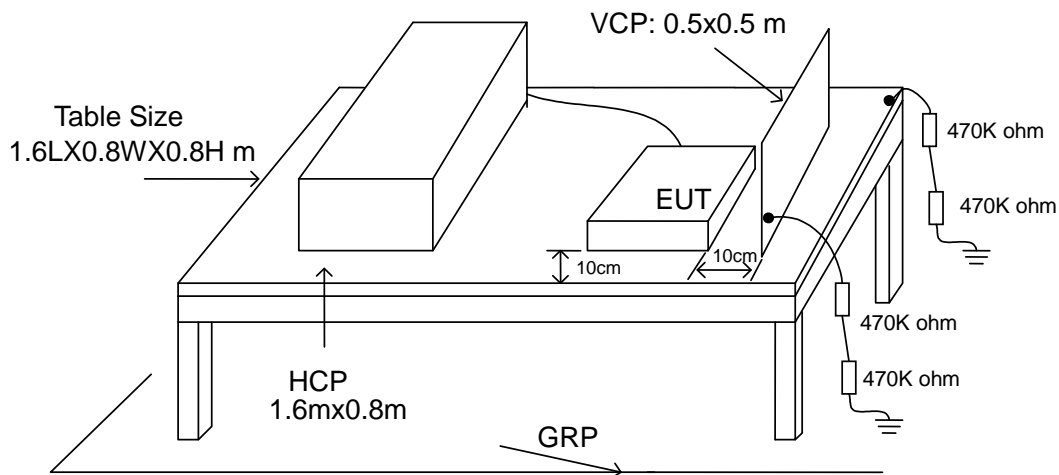

The test setup consists of the test generator, EUT and auxiliary instrumentation necessary to perform DIRECT and INDIRECT application of discharges to the EUT as applicable, in the following manner :

- b. Contact Discharge to the conductive surfaces and to coupling plane;
- c. Air Discharge at insulating surfaces.

The preferred test method is that of type tests performed in laboratories and the only accepted method of demonstrating conformance with this standard. The EUT was arranged as closely as possible to arrangement in final installed conditions.

A ground reference plane was provided on the floor of the test site. It was a metallic sheet (copper or aluminum) of 0.25 mm, minimum thickness; other metallic may be used but they shall have at least 0.65 mm thickness. In the CerpPASS Technology Corp., we provided 1 mm thickness stainless steel ground reference plane. The minimum size of the ground reference plane is 2.5 m x 2.5 m, the exact size depending on the dimensions of the EUT. It was connected to the protective grounding system.

The EUT was arranged and connected according to its functional requirements. A distance of 1m minimum was provided between the EUT and the wall of the lab. and any other metallic structure. In cases where this length exceeds the length necessary to apply the discharges to the selected points, the excess length shall, where possible, be placed non-inductively off the ground reference plane and shall not come closer than 0.2m to other conductive parts in the test setup.

Where the EUT is installed on a metal table, the table was connected to the reference plane via a cable with a 470k ohm resistor located at each end, to prevent a build-up of charge. The test setup was consist a wooden table, 0.8m high, standing on the ground reference plane. A HCP, 1.6 m x 0.8 m, was placed on the table. The EUT and cables was isolated from the HCP by an insulating support 0.5 mm thick. The VCP size, 0.5 m x 0.5 m.



8.3. Test Severity Levels

Contact Discharge		Air Discharge	
Level	Test Voltage (KV) of Contact discharge	Level	Test Voltage (KV) of Air Discharge
1	±2	1	±2
2	±4	2	±4
3	±6	3	±8
4	±8	4	±15
X	Specified	X	Specified

Remark: "X" is an open level.

8.4. Measurement Equipment

Instrument/Ancillary	Manufacturer	Model No.	Serial No.	Calibration Date	Valid Date.
ESD Simulator	EM Test	Dito	P1645186902	2017.02.16	2018.02.15
Tonometer	shanghaifengyun	DYM3	3251	2016.12.21	2017.12.20
Dehumidifier	ZEDO	ZD-220LB	CEP-TH-01	N/A	N/A
Humidifier	YADU	YZ-DS251C	CEP-TH-02	N/A	N/A
Temperature/ Humidity Meter	feiyang	N/A	102	2017.03.28	2018.03.27
ESD Simulator	NoiseKen	ESS-B3011A	AEC00315-00 C-0A	2016.12.12	2017.12.11



8.5. Test Result and Data

Final Test Result : **PASS**
 Pass performance criteria : B
 Basic Standard : IEC 61000-4-2
 Model No. : 270LM00043
 Test Voltage : ±2 / ±4 / ±8 KV for air discharge,
 ±2 / ±4 KV for contact discharge
 Temperature : 24°C
 Relative Humidity : 48 %
 Atmospheric Pressure : 100 kPa
 Test Date : May 16, 2017

Test Mode : Mode 1,5,9,14

	Contact Discharge								Air Discharge							
	25 times / each								10 times / each							
Voltage	2 kV		4 kV		6 kV		8 kV		2 kV		4 kV		8 kV		10 kV	
HCP	A	A	A	A	---	---	---	---	---	---	---	---	---	---	---	---
VCP	A	A	A	A	---	---	---	---	---	---	---	---	---	---	---	---
Screw	A	A	A	A	---	---	---	---	---	---	---	---	---	---	---	---
Case	---	---	---	---	---	---	---	---	A	A	A	A	A	A	---	---
Panel	---	---	---	---	---	---	---	---	A	A	A	A	A	A	---	---
VGA Port	A	A	A	A	---	---	---	---	A	A	A	A	A	A	---	---
DP Port	A	A	A	A	---	---	---	---	A	A	A	A	A	A	---	---
HDMI1 Port	A	A	A	A	---	---	---	---	A	A	A	A	A	A	---	---
HDMI2 Port	A	A	A	A	---	---	---	---	A	A	A	A	A	A	---	---
Audio Port	---	---	---	---	---	---	---	---	A	A	A	A	A	A	---	---
Power Port	---	---	---	---	---	---	---	---	A	A	A	A	A	A	---	---
Button	---	---	---	---	---	---	---	---	A	A	A	A	A	A	---	---
LED Light	---	---	---	---	---	---	---	---	A	A	A	A	A	A	---	---

Test engineer: Sun. Zhang



8.6. Test Photographs





9. Radio Frequency electromagnetic field immunity test

9.1. Test Procedure

- a. The equipment to be tested is placed in the center of the enclosure on a wooden table. The equipment is then connected to power and signal leads according to pertinent installation instructions.
- b. The antenna which is enabling the complete frequency range of 80-1000 MHz is placed 3m away from the equipment. The required field strength is determined by placing the field strength meter(s) on top of or directly alongside the equipment under test and monitoring the field strength meter via a remote field strength indicator outside the enclosure while adjusting the continuous-wave to the applicable antennae.
- c. The test is normally performed with the antenna facing the most sensitive side of the EUT. The polarization of the field generated by the bucolical antenna necessitates testing each position twice, once with the antenna positioned vertically and again with the antenna positioned horizontally. The circular polarization of the field from the log-spiral antenna makes a change of position of the antenna unnecessary.
- d. At each of the above conditions, the frequency range is swept 80-1000 MHz, pausing to adjust the R.F. signal level or to switch oscillators and antenna. The rate of sweep is in the order of 1.5×10^{-3} decades/s. The sensitive frequencies or frequencies of dominant interest may be discretely analyzed.

9.2. Test Severity Levels

Frequency Band : 80-1000 MHz	
Level	Test field strength (V/m)
1	1
2	3
3	10
X	Specified
Remark: "X" is an open class.	

9.3. TEST SETUP

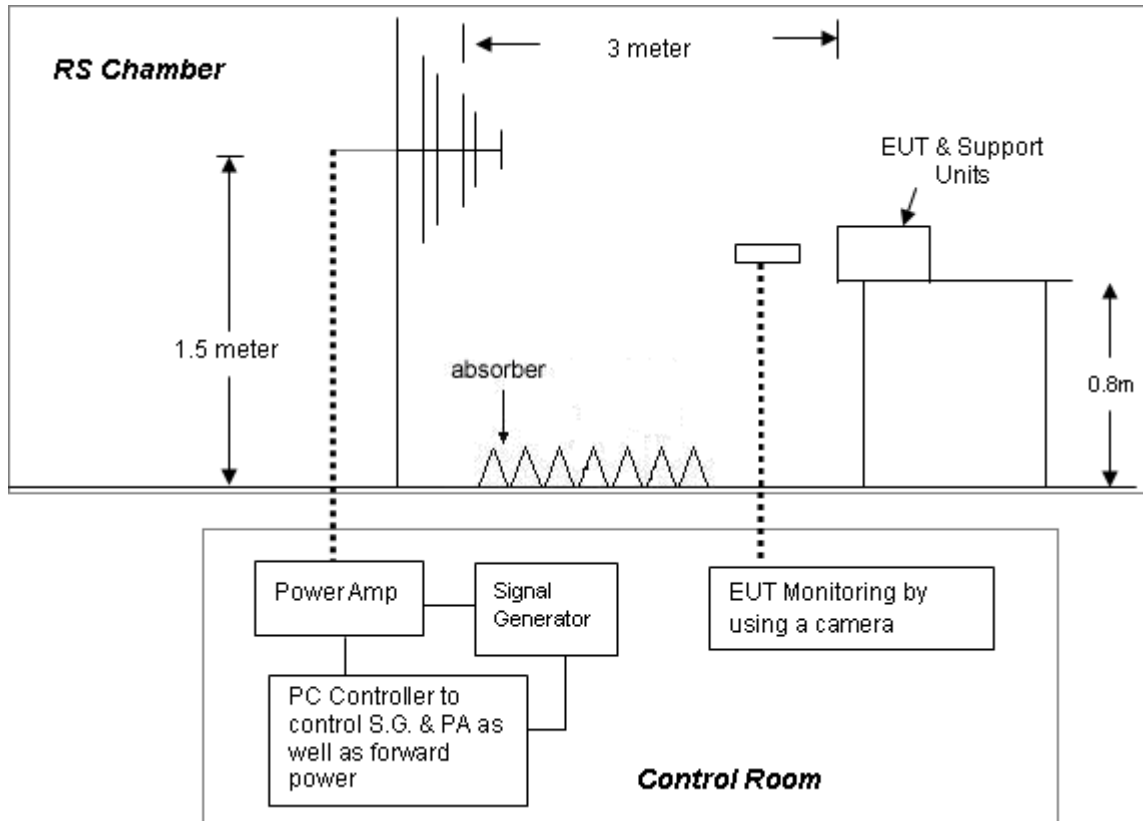

- For the actual test configuration, please refer to the related item – Photographs of the Test Configuration.

NOTE:

TABLETOP EQUIPMENT

The EUT installed in a representative system as described in section 7 of IEC 61000-4-3 was placed on a non-conductive table 0.8 meters in height. The system under test was connected to the power and signal wire according to relevant installation instructions.

FLOOR STANDING EQUIPMENT

The EUT installed in a representative system as described in section 7 of IEC 61000-4-3 was placed on a non-conductive wood support 0.1 meters in height. The system under test was connected to the power and signal wire according to relevant installation instructions.



9.4. Measurement Equipment

Instrument/Ancillary	Manufacturer	Model No.	Serial No.	Calibration Date	Valid Date.
Signal Generator	R&S	SML03	103287	2017.03.22	2018.03.21
Power Sensor	R&S	NR P-Z91	100383	2017.03.22	2018.03.21
Power Meter	R&S	NRP	101206	2017.03.22	2018.03.21
Power Amplifier	BONN	BLWA0830-16 0/100/40D	076659	2017.03.22	2018.03.21
Istropic Electric Field Probe	EST.LINDGRE N	HI-6105	137445	2016.11.20	2017.11.19
EMS Antenna	R&S	HL046E	100028	N/A	N/A
Temperature/ Humidity Meter	feiyang	N/A	101	2017.03.28	2018.03.27
EMC-32	Rohde&Schwa rz	Ver 6.10.0	N/A	N/A	N/A



9.5. Test Result and Data

Final Test Result : **PASS**
 Pass performance criteria : A
 Basic Standard : IEC 61000-4-3
 Model No. : 270LM00043
 Frequency Range : 80~1000 MHz
 Temperature : 25°C
 Relative Humidity : 52%
 Atmospheric Pressure : 100 kPa
 Test Date : May 16, 2017

Test Mode: Mode 1,5,9,14

Modulation : AM 80% , 1KHz sine wave , Dwell time: 3.0 S				
Frequency Step Size : 1 % of preceding frequency value				
Frequency (MHz)	Antenna Polarization	face	Field strength (V/m)	Result
80~1000	Vertical	Front	3 V/m	A
80~1000	Vertical	Rear	3 V/m	A
80~1000	Vertical	Left	3 V/m	A
80~1000	Vertical	Right	3 V/m	A
80~1000	Horizontal	Front	3 V/m	A
80~1000	Horizontal	Rear	3 V/m	A
80~1000	Horizontal	Left	3 V/m	A
80~1000	Horizontal	Right	3 V/m	A

Test engineer: Sun. Zhang



9.6. Test Photographs





10. Electrical Fast Transient/ Burst Immunity Test

10.1. Test Procedure

- a. In order to minimize the effect of environmental parameters on test results, the climatic conditions when test is carrying out shall comply with the following requirements:
 - ambient temperature: 15°C to 35°C;
 - relative humidity : 45% to 75%;
 - Atmospheric pressure: 86 Kpa (860 mbar) to 106 Kpa (1060 mbar).
- b. In order to minimize the effect of environmental parameters on test results, the electromagnetic environment of the laboratory shall not influence the test results.
- c. The variety and diversity of equipment and systems to be tested make it difficult to establish general criteria for the evaluation of the effects of fast transients/bursts on equipment and systems.
- d. Test on Power Line:
 - The EFT/B-generator was located on the GRP.
For floor standing equipment 1,0 m
For table top equipment 0,5 m
 - The EFT/B-generator provides the ability to apply the test voltage in a non-symmetrical condition to the power supply input terminals of the EUT.
- e. Test on Communication Lines
 - The coupling clamp is composed of a clamp unit for housing the cable (length more than 3 m), and was placed on the GRP.
 - The coupling clamp provides the ability of coupling the fast transient/bursts to the cable under test.
- f. The test results may be classified on the basic of the operating conditions and the functional specification of the equipment under test, according to the following performance criteria :
 - Normal performance within the specification limits.
 - Temporary degradation or loss of function or performance which is self-recoverable.
 - Temporary degradation or loss of function or performance which requires operator intervention or system reset.
 - Degradation or loss of function which is not recoverable due to damage of equipment (components).

10.2. Test Severity Levels

The following test severity levels are recommended for the fast transient/burst test :

Open circuit output test voltage $\pm 10\%$		
Level	On Power Supply	On I/O signal, data and control line
1	0.5 KV	0.25 KV
2	1.0 KV	0.50 KV
3	2.0 KV	1.00 KV
4	4.0 KV	2.00 KV
X	Specified	Specified

Remark : “ X ” is an open level. The level is subject to negotiation between the user and manufacturer or is specified by the manufacturer.

10.3. TEST SETUP

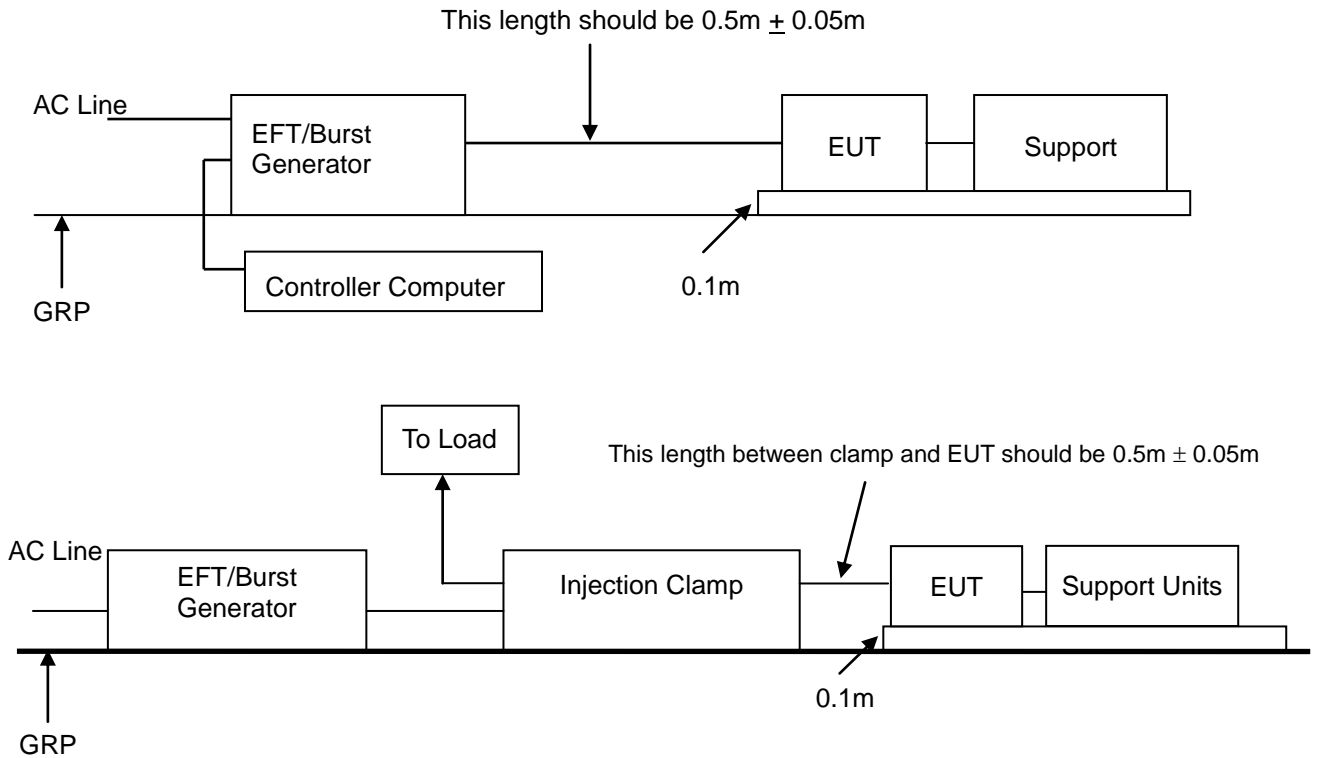

- For the actual test configuration, please refer to the related item – Photographs of the Test Configuration.

NOTE:

TABLETOP EQUIPMENT

The configuration consisted of a wooden table (0.1m high) standing on the Ground Reference Plane. The GRP consisted of a sheet of aluminum (at least 0.25mm thick and 2.5m square) connected to the protective grounding system. A minimum distance of 0.5m was provided between the EUT and the walls of the laboratory or any other metallic structure.

FLOOR STANDING EQUIPMENT

The EUT installed in a representative system as described in section 7 of IEC 61000-4-4 and its cables, were isolated from the Ground Reference Plane by an insulating support that is 0.1-meter thick. The GRP consisted of a sheet of aluminum (at least 0.25mm thick and 2.5m square) connected to the protective grounding system.

10.4. Measurement Equipment

Instrument/Ancillary	Manufacturer	Model No.	Serial No.	Calibration Date	Valid Date.
TRANSIENT	EMCPARTNER	TRA2000IN6	901	2016.06.26	2017.06.25
CDN	EMCPARTNER	CDN2000-06-32	121	2017.03.22	2018.03.21
Coupling clamp	EMCPARTNER	CN-EFT1000	547	2017.03.22	2018.03.21
Temperature/ Humidity Meter	Zhicheng	ZC1-11	CEP-TH-005	2017.03.28	2018.03.27



10.5. Test Result and Data

Final Test Result : **PASS**
 Pass performance criteria : B
 Basic Standard : IEC 61000-4-4
 Model No. : 270LM00043
 Test Voltage : On Power Supply -- ±1.0 kV
 : On I/O signal, data and control line -- ±0.5 kV
 Temperature : 25 °C
 Relative Humidity : 53%
 Atmospheric Pressure : 100 kPa
 Test Date : May 17, 2017

Test Mode: Mode 1,5,9,14

Pulse : 5/50 ns		Repetition Rate: <u>5 kHz</u>			
Burst : 15m/300ms					
Test time : 1 min/each condition					
Voltage/ Mode/ Polarity/ Result/ Phase		<u>0.5 kV</u>		<u>1.0 kV</u>	
		+	-	+	-
Power Line	L	---	---	A	A
	N	---	---	A	A
	L-N	---	---	A	A
	PE	---	---	A	A
	L-PE	---	---	A	A
	N-PE	---	---	A	A
	L-N-PE	---	---	A	A

Test engineer: Sun. Zhang



10.6. Test Photographs





11. Surge Immunity Test

11.1. Test Procedure

- a. Climatic conditions
The climatic conditions shall comply with the following requirements :
 - ambient temperature : 15 °C to 35 °C
 - relative humidity : 10 % to 75 %
 - atmospheric pressure : 86 kPa to 106 kPa (860 mbar to 1060 mbar)
- b. Electromagnetic conditions
the electromagnetic environment of the laboratory shall not influence the test results.
- c. The test shall be performed according the test plan that shall specify the test set-up with
 - generator and other equipment utilized;
 - test level (voltage/current);
 - generator source impedance;
 - internal or external generator trigger;
 - number of tests : at least five positive and five negative at the selected points;
 - repetition rate : maximum 1/min.
 - inputs and outputs to be tested;
 - representative operating conditions of the EUT;
 - sequence of application of the surge to the circuit;
 - phase angle in the case of AC. power supply;
 - actual installation conditions, for example :
 - AC : neutral earthed,
 - DC : (+) or (-) earthed to simulated the actual earthing conditions.
- d. If not otherwise specified the surges have to be applied synchronized to the voltage phase at the zero-crossing and the peak value of the AC. voltage wave (positive and negative).
- e. The surges have to be applied line to line and line(s) and earth. When testing line to earth, the test voltage has to be applied successively between each of the lines and earth, if there is no other specification.
- f. The test procedure shall also consider the non-linear current-voltage characteristics of the equipment under test. Therefore the test voltage has to be increased by steps up to the test level specified in the product standard or test plan.
- g. All lower levels including the selected test level shall be satisfied. For testing the secondary protection, the output voltage of the generator shall be increased up to the worst-case voltage breakdown level (let-through level) of the primary protection.
- h. If the actual operating signal sources are not available, that may be simulated. Under no circumstances may the test level exceed the product specification. The test shall be carried out according to a test plan.
- i. To find all critical points of the duty cycle of the equipment, a sufficient number of positive and negative test pulses shall be applied. For acceptance test previously unstressed equipment shall be used to the protection devices shall be replaced.

11.2. Test Severity Level

Level	Open-circuit test voltage, ± 10%, KV
1	0.5
2	1.0
3	2.0
4	4.0
X	Specified
NOTE: "X" is an open class. This level can be specified in the product specification.	



11.3. TEST SETUP

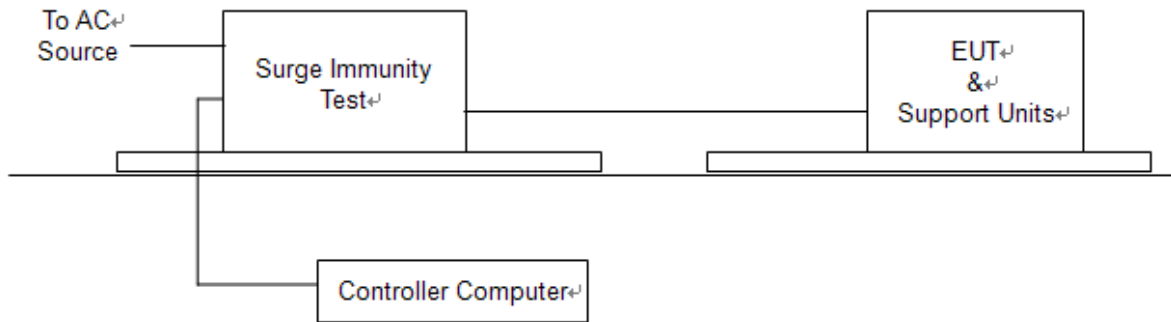

For the actual test configuration, please refer to the related item – Photographs of the Test Configuration.

11.4. Measurement Equipment

Instrument/Ancillary	Manufacturer	Model No.	Serial No.	Calibration Date	Valid Date.
TRANSIENT	TESEQ	NSG 3060	1830	2017.02.22	2018.02.21
CDN	TESEQ	CDN 3061	1575	2017.02.22	2018.02.21
CDN	TESEQ	CNV508T5	P 1546167499	2017.02.22	2018.02.21
CDN	TESEQ	CDN HSS-2	41020	2017.02.22	2018.02.21
Temperature/ Humidity Meter	Zhicheng	ZC1-11	CEP-TH-005	2017.03.28	2018.03.27



11.6. Test Photographs





12. Conduction Disturbances induced by Radio-Frequency Fields

12.1. Test Procedure

- a. The EUT shall be operated within its intended climatic conditions. The temperature and relative humidity should be recorded.
- b. This test method test can be performed without using a sell shielded enclosure. This is because the disturbance levels applied and the geometry of the setups are not likely to radiated a high amount of energy, especially at the lower frequencies. If under certain circumstances the radiated energy is too high, a shielded enclosure has to be used.
- c. The test shall be performed with the test generator connected to each of the coupling and decoupling devices in turn while the other non-excited RF-input ports of the coupling devices are terminated by a 50 ohm load resistor.
- d. The frequency range is swept from 150 KHz to 80 MHz, using the signal levels established during the setting process, and with the disturbance signal 80% amplitude modulated with a 1KHz sign wave, pausing to adjust the RF-signal level or to switch coupling devices as necessary. The rate of sweep shall no exceed 1.5×10^{-3} decades/s. Where the frequency is swept incrementally, the step size shall no exceed 1% of the start and thereafter 1% of the preceding frequency value.
- e. The dwell time at each frequency shall not be less than the time necessary for the EUT to be exercised, and able to respond. Sensitive frequencies e.g. clock frequency (ies) and harmonics or frequencies of dominant interest shall be analyzed separately.
- f. An alternative test procedure may be adopted, wherein the frequency range is swept incrementally, with a step size not exceeding 4% of the start ad thereafter 4% of the preceding frequency value. The test level should be at least twice the value of the specified test level.
- g. In cases of dispute, the test procedure using a step size not exceeding 1% of the start and thereafter 1% of preceding frequency value shall take precedence.
- h. Attempts should be made to fully exercise the EUT during testing, and to fully interrogate all exercise modes selected for susceptibility.
- i. The use of special exercising programs is recommended.
- j. Testing shall be performed according to a Test Plan, which shall be included in the test report.
- k. It may be necessary to carry out some investigatory testing in order to establish some aspects of the test plan.

12.2. Test Severity Levels

Level	Voltage Level (e.m.f.)
1	1 V
2	3 V
3	10 V
x	Specified
NOTE - x is an open class. This level can be specified in the product specification.	

12.3. TEST SETUP

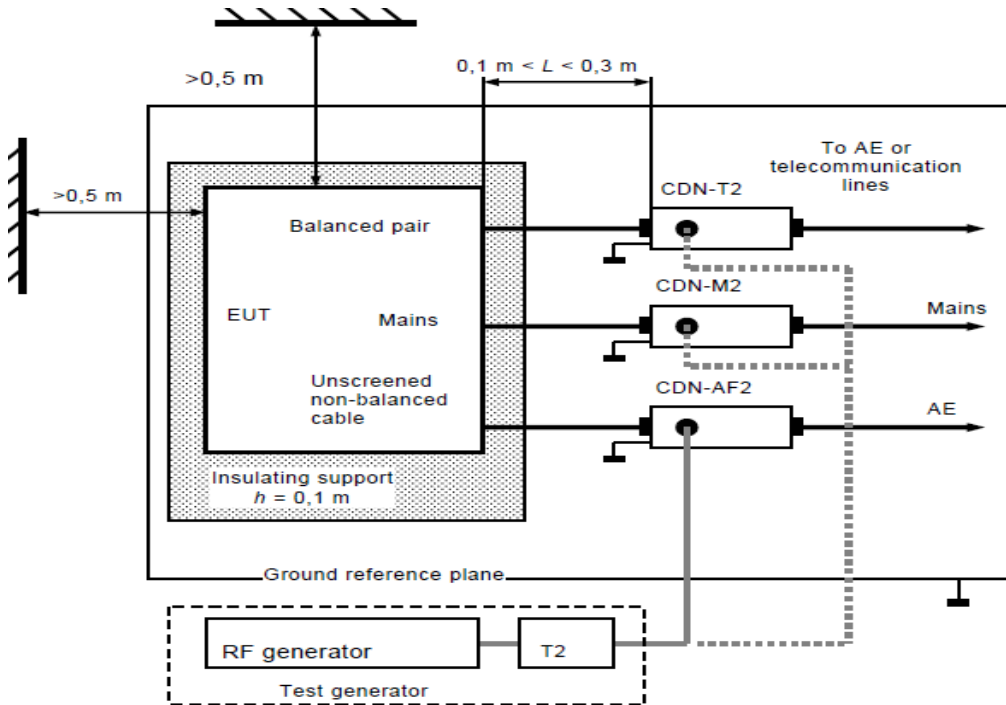

- Note:**
1. The EUT is setup 0.1m above Ground Reference Plane
 2. The CDNs and / or EM clamp used for real test depends on ports and cables configuration of EUT.
 3. For the actual test configuration, please refer to the related item – Photographs of the Test Configuration.

12.4. Measurement Equipment

Instrument/Ancillary	Manufacturer	Model No.	Serial No.	Calibration Date	Valid Date.
Conducted immunity test system	FRANKONIA	CIT-10/75	102D1294	2017.03.22	2018.03.21
EM Injection clamp	FCC	F-203I-23MM	536	2017.03.22	2018.03.21
CDN	FRANKONIA	CDN-M2+M3	A3011102	2017.03.22	2018.03.21
CDN	FCC	CDN-M5/32	A3013024	2017.03.22	2018.03.21
CDN	TESEQ	CDN T8-10	43767	2016.09.08	2017.09.07
CDN	TESEQ	CDN T2-10	43762	2016.08.30	2017.08.29
CDN	TESEQ	CDN T4-10	43754	2016.09.08	2017.09.07
CDN	TESEQ	CDN M016	44025	2016.09.12	2017.09.11
6 dB Attenuator	FRANKONIA	N/A	N/A	2017.03.22	2018.03.21
Temperature/ Humidity Meter	Zhicheng	ZC1-11	CEP-TH-005	2017.03.28	2018.03.27
EN61000-4-6	Hubert GmbH	Ver 2.21	N/A	N/A	N/A



12.6. Test Photographs



13. Power Frequency Magnetic Field Immunity Test

13.1. Test Setup

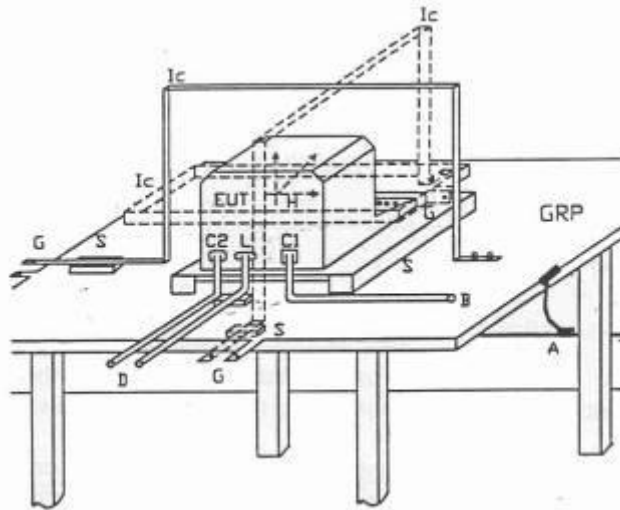

- GPR : Ground plane
- A : Safety earth
- S : Insulating support
- EUT : Equipment under test
- Lc : Induction coil
- E : Earth terminal
- C1 : Power supply circuit
- C2 : Signal circuit
- L : Communication line
- B : To power supply source
- D : To signal source, simulator
- G : To the test generator

13.2. Test Severity Levels

Level	Magnetic field strength (A/m)
1	1
2	3
3	10
4	30
5	100
X ¹⁾	special

NOTE 1 "X" is an open level. This level can be given in the product specification.

13.3. Measurement Equipment

Instrument/Ancillary	Manufacturer	Model No.	Serial No.	Calibration Date	Valid Date.
TRANSIENT	EMCPARTNER	TRA2000IN6	901	2016.06.26	2017.06.25
H-Filed-Loop	EMCPARTNER	MF1000-1	144	2017.03.22	2018.03.21
Temperature/ Humidity Meter	Zhicheng	ZC1-11	CEP-TH-005	2017.03.28	2018.03.27



13.4. Test Result and Data

Final Test Result : **PASS**
 Pass performance criteria : A
 Basic Standard : IEC 61000-4-8
 Model No. : 270LM00043
 Temperature : 25°C
 Relative Humidity : 53%
 Atmospheric Pressure : 100 kPa
 Test Date : May 17, 2017

Test Mode: Mode 1,5,9,14

Power Frequency Magnetic Field : <u>50</u> Hz, <u>1</u> A/m		
Coil Orientation	Testing duration	Results
X-axis	1.0 Min	A
Y-axis	1.0 Min	A
Z-axis	1.0 Min	A
Power Frequency Magnetic Field : <u>60</u> Hz, <u>1</u> A/m		
Coil Orientation	Testing duration	Results
X-axis	1.0 Min	A
Y-axis	1.0 Min	A
Z-axis	1.0 Min	A

Test engineer: Sun. Zhang



13.5. Test Photographs



14. Voltage Dips and Voltage Interruptions Immunity Test Setup

14.1. Test Conditions

1. Source voltage and frequency : AC 100/230/240V / 50Hz, Single phase.
2. Test of interval : 10 sec.
3. Level and duration : Sequence of 3 dips/interrupts.
4. Voltage rise (and fall) time : 1 ~ 5 μ s.
5. Test severity :

Voltage dips and Interrupt reduction (%)	Test Duration (period)
>95%	250
30%	25
>95%	0.5

14.2. TEST SETUP

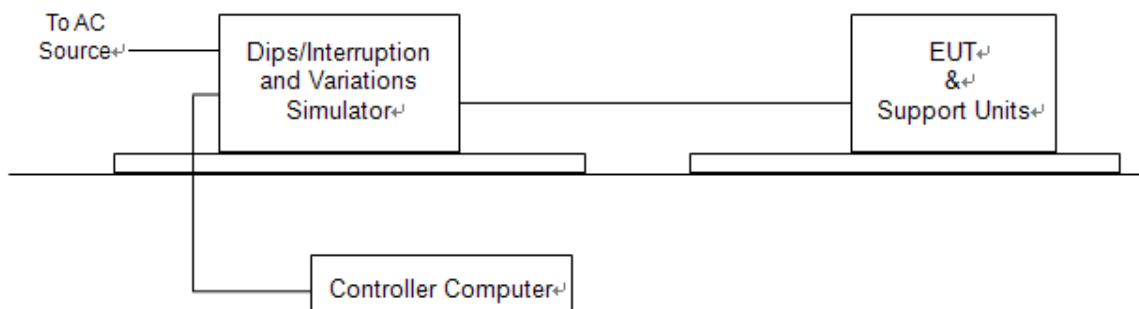

For the actual test configuration, please refer to the related item – Photographs of the Test Configuration.

14.3. Measurement Equipment

Instrument/Ancillary	Manufacturer	Model No.	Serial No.	Calibration Date	Valid Date.
TRANSIENT	EMCPARTNER	TRA2000IN6	901	2016.06.26	2017.06.25
Temperature/ Humidity Meter	Zhicheng	ZC1-11	CEP-TH-005	2017.03.28	2018.03.27



14.4. Test Result and Data

Final Test Result : **PASS**
 Pass performance criteria : C for voltage interruption, B for voltage dips
 Basic Standard : IEC 61000-4-11
 Model No. : 270LM00043
 Temperature : 25°C
 Relative Humidity : 53%
 Atmospheric Pressure : 100 kPa
 Test Date : May 17, 2017

Test Mode: Mode 1,5,9,14

Voltage(UT): AC 230 V/240V 50 Hz Interval(s) : 10s Times : 3										
Test mod	Test level UT %	Durations (period / ms)	Phase / Result							
			0	45	90	135	180	225	270	315
Voltage interruptions	>95%	250	C	C	C	C	C	C	C	C
Voltage dips	30%	25	A	A	A	A	A	A	A	A
	>95%	0.5	A	A	A	A	A	A	A	A

Test Mode: Mode 1, 5,9,14

Voltage(UT): AC 100 V 50 Hz Interval(s) : 10s Times : 3										
Test mod	Test level UT %	Durations (period / ms)	Phase / Result							
			0	45	90	135	180	225	270	315
Voltage interruptions	>95%	250	C	C	C	C	C	C	C	C
Voltage dips	30%	25	B	B	B	B	B	B	B	B
	>95%	0.5	B	B	B	B	B	B	B	B

Test engineer: Sun. Zhang



14.5. Test Photographs





15. Photographs of EUT

1) EUT Photo

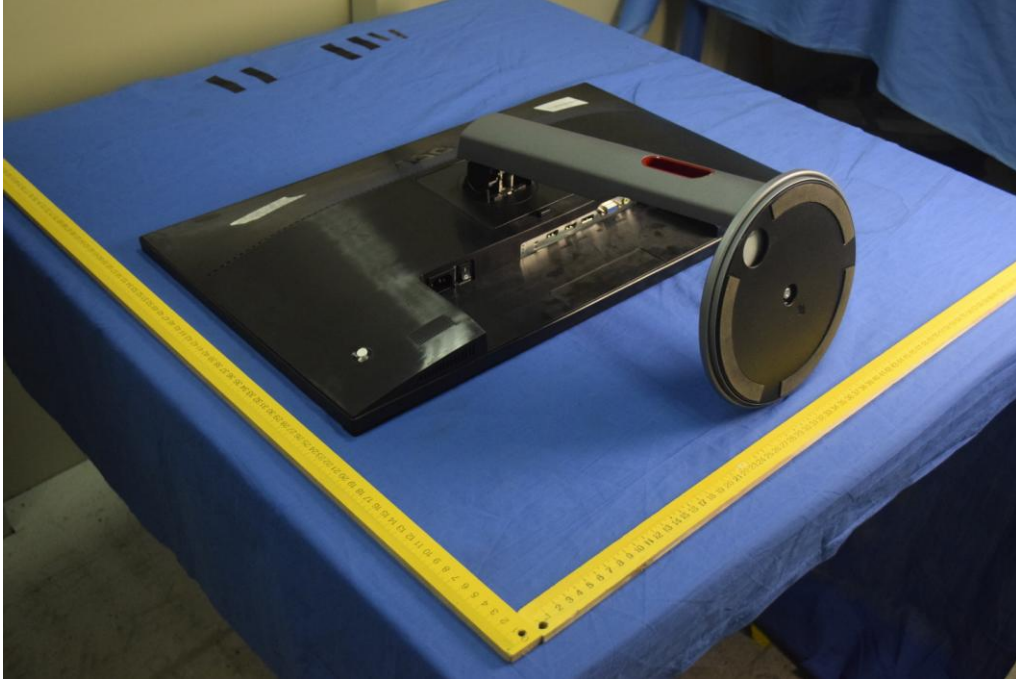

2) EUT Photo

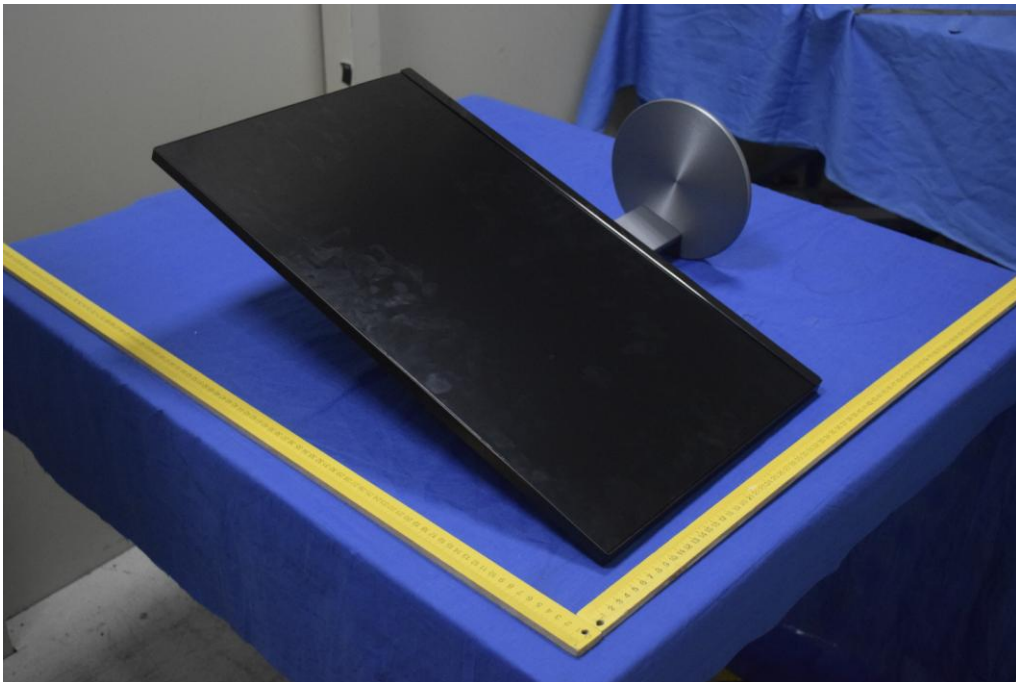



3) EUT Photo



4) EUT Photo





5) EUT Photo



6) EUT Photo

