



EMC TEST REPORT

Applicant : TPV Electronics (Fujian) Co., Ltd.
Rongqiao Economic and Technological
Address : Development Zone, Fuqing City, Fujian Province,
P.R. China
Equipment : LCD Monitor
Model No. : 24G2,**24G2***** (*=0-9,A-Z,a-z,+,-,/,\ or blank)

I HEREBY CERTIFY THAT :

The sample was received on Jun. 27, 2019 and the testing was carried out on Jul. 11, 2019 at CerpPASS Technology Corporation. The test result refers exclusively to the test presented test model / sample. Without written approval of CerpPASS Technology Corp., the test report shall not be reproduced except in full.

Approved by:

Kero Kuo / EMC & RF Manager

Laboratory Accreditation:

CerpPASS Technology Corporation Test Laboratory





Contents

1. Summary of Test Procedure and Test Result.....	4
1.1. Applicable Standards	4
2. Test Configuration of Equipment under Test	5
2.1. Feature of Equipment under Test.....	5
2.2. Test Manner	6
2.3. Description of Test System.....	7
2.4. General Information of Test.....	8
2.5. Measurement Uncertainty	8
3. Test of Conducted Emission.....	9
3.1. Test Limit	9
3.2. Test Procedures	9
3.3. Typical test Setup.....	10
3.4. Measurement Equipment.....	10
3.5. Test Result and Data.....	11
3.6. Test Photographs	13
4. Test of Radiated Emission	14
4.1. Test Limit	14
4.2. Test Procedures	15
4.3. Typical test Setup.....	15
4.4. Measurement Equipment.....	16
4.5. Test Result and Data (30MHz ~ 1GHz).....	17
4.6. Test Result and Data (1GHz ~ 18GHz).....	19
4.7. Test Photographs (30MHz ~ 1GHz).....	21
4.8. Test Photographs (1GHz ~ 18GHz)	22



1. Summary of Test Procedure and Test Result

1.1. Applicable Standards

FCC

The measurements shown in this test report were made in accordance with the procedures given in ANSI C63.4 – 2014 and the energy emitted by this equipment was passed, Part 15, CISPR PUB. 22.

Canada

The measurements shown in this test report were made in accordance with the procedures given in Canada ICES-003 issue 6 section 3.a and 3.b.

The energy emitted by this equipment was passed both Radiated and Conducted Emissions Class **B** limits.

Test Item	Normative References	Test Result	Remarks
Conducted Emission	ANSI C63.4-2014, FCC Part 15 Subpart B, KDB174176, Canada ICES-003 issue 6	PASS	Meets Class B Limit Minimum passing margin(QP) is -20.56dB at 2.74 MHz
Radiated Emission	ANSI C63.4-2014, FCC Part 15 Subpart B, KDB174176, Canada ICES-003 issue 6	PASS	Meets Class B Limit Minimum passing margin(QP) is -4.24 dB at 148.34 /194.90 MHz



2. Test Configuration of Equipment under Test

2.1. Feature of Equipment under Test

Product Name:	LCD Monitor
Model Name:	24G2,**24G2*****(*=0-9,A-Z,a-z,+,-,/,\ or blank)
Housing material:	Plastic case
EUT Highest Frequency:	350 MHz
EUT Power Rating:	Input: 100-240V~, 50/60Hz 3Pin Power Port
AC Power Cord Type:	shielded, 1.5m&1.8m

Note: Please refer to user manual.

I/O PORT:

I/O PORT TYPE	Quantity
1). HDMI Port	2
2). DP Port	1
3). VGA Port	1
4). Audio Port	2
5). USB Port	5
6). Power Port	1



2.2. Test Manner

- a. During testing, the interface cables and equipment positions were varied according to ANSI C63.4.
- b. The complete test system included PC, Keyboard, Mouse, Printer, iPod, Earphone, HDD and EUT for EMI test.
- c. An executive program, "BURNIN.EXE & MyHwin" under WIN 8, which generates a complete line of continuously repeating "H" pattern were used as the test software.
The program was executed as follows:
 - 1. Turn on the power of all equipment.
 - 2. The PC reads the test program from the hard disk drive and runs it.
 - 3. The PC sends "H" messages to the EUT, and the EUT displays "H" patterns on the screen.
 - 4. The PC sends "H" messages to the internal Hard Disk, and the Hard Disk reads and writes the message.
 - 5. The PC sends "H" messages to the printer, then the printer prints them on the paper.
 - 6. Repeat the steps from 2 to 5.
- d. An executive program, "COLORBAR.EXE" was executed to play 1kHz audio.
- e. The maximum operating frequency is above 148.5MHz, the test frequency range is from 30MHz to 18GHz.
- f. The test modes of EMI test as follows:

Conducted Emissions from the AC mains power ports & Radiation Emissions	
Test Mode	Operating Description
Test Mode 1	Full system (VGA mode 1920*1080@60Hz) Signal from PC for Horizontal
Test Mode 2	Full system (VGA mode 1280*1024@60Hz) Signal from PC for Horizontal
Test Mode 3	Full system (VGA mode 640*480@60Hz) Signal from PC for Horizontal
Test Mode 4	Full system (VGA mode 1920*1080@60Hz) Signal from PC for Vertical
Test Mode 5	Full system (HDMI 1mode 1920*1080@144Hz) Signal from PC for Horizontal
Test Mode 6	Full system (HDMI 1mode 1280*1024@60Hz) Signal from PC for Horizontal
Test Mode 7	Full system (HDMI 1mode 640*480@60Hz) Signal from PC for Horizontal
Test Mode 8	Full system (HDMI 1mode 1080P) Signal from DVD for Horizontal
Test Mode 9	Full system (HDMI 1mode 1920*1080@144Hz) Signal from PC for Vertical
Test Mode 10	Full system (Display mode 1920*1080@144Hz) Signal from PC for Horizontal
Test Mode 11	Full system (Display mode 1280*1024@60Hz) Signal from PC for Horizontal
Test Mode 12	Full system (Display mode 640*480@60Hz) Signal from PC for Horizontal
Test Mode 13	Full system (Display mode 1920*1080@144Hz) Signal from PC for Vertical
Test Mode 14	Full system (HDMI 2 mode 1920*1080@144Hz) Signal from PC for Horizontal
Test Mode 15	Full system (HDMI 2 mode 1280*1024@60Hz) Signal from PC for Horizontal
Test Mode 16	Full system (HDMI 2 mode 640*480@60Hz) Signal from PC for Horizontal
Test Mode 17	Full system (HDMI 2mode 1080P) Signal from DVD for Horizontal
Test Mode 18	Full system (HDMI 2 mode 1920*1080@144Hz) Signal from PC for Vertical
Test Mode 19	Full system (VGA mode 1920*1080@60Hz) Signal from PC USB with Load(5.0V/2.1A) for Horizontal

caused "Test Mode 1" generates the worst case, it was reported as the final data.



2.3. Description of Test System

No.	Device	Manufacturer	Model No.	Description
1	PC	DELL	XPS8700	Power Cable, Non-Shielded, 1.8m
2	Keyboard	DELL	SK-8175	USB Cable, Shielding 1.85m
3	Mouse	DELL	MS111-P	USB Cable, Shielding 1.85m
4	Printer	HP	P1102w	USB Cable, Shielding 1.6m
5	iPod	APPLE	A1320	USB Cable, Shielding 1.0m
6	Earphone	APPLE	EarPods	Audio Cable, Non-Shielded 1.35m
7	USB 3.0 HDD*4	TOSHIBA	DTD210 1TB	USB3.0 Cable, Shielding 3.0m USB3.0 Cable, Shielding 0.5m

Use Cable

Cable	Quantity	Description
Audio Cable	1	Non-Shielded, 1.8m
HDMI Cable	2	Shielded, 1.5m
HDMI Cable	2	Shielded, 1.8m
VGA Cable	1	Shielded, 1.5m
VGA Cable	1	Shielded, 1.8m
Display Cable	1	Shielded, 1.5m
Display Cable	1	Shielded, 1.8m
USB A to B	1	Shielded, 1.8m



2.4. General Information of Test

Test Site :	Cerpass Technology Corporation Test Laboratory Address: No.10, Ln. 2, Lianfu St., Luzhu Dist., Taoyuan City 33848, Taiwan (R.O.C.) Tel:+886-3-3226-888 Fax:+886-3-3226-881 Address: No.68-1, Shihbachongsi, Shihding Township, New Taipei City 223, Taiwan, R.O.C. Tel: +886-2-2663-8582
FCC Registration Number :	TW1079, TW1061, TW1439
IC Registration Number :	4934E-1, 4934E-2
VCCI	T-2205 for Telecommunication Test C-4663 for Conducted emission test R-4218 for Radiated emission test G-10812 for radiated disturbance above 1GHz
Frequency Range Investigated :	Conducted Emission Test: from 150 kHz to 30 MHz Radiated Emission Test: from 30 MHz to 18,000 MHz
Test Distance :	The test distance of radiated emission below 1GHz from antenna to EUT is 10 M. The test distance of radiated emission above 1GHz from antenna to EUT is 3 M.

2.5. Measurement Uncertainty

Measurement Item	Measurement Frequency	Polarization	Uncertainty
Conducted Emission	9 kHz ~ 30 MHz	LINE / NEUTRAL	± 3.25 dB
Radiated Emission	30 MHz ~ 1,000 MHz	Vertical / Horizontal	± 3.93 dB
	1,000 MHz ~ 6,000 MHz	Vertical / Horizontal	± 4.01 dB
	6,000 MHz ~ 18,000 MHz	Vertical / Horizontal	± 4.72 dB

The measurement uncertainty will be considered, when test result margin to the limit.



3. Test of Conducted Emission

3.1. Test Limit

Conducted Emissions were measured from 150 kHz to 30 MHz with a bandwidth of 9 KHz, according to the methods defined in ANSI C63.4-2014. The EUT was placed on a nonmetallic stand in a shielded room 0.8 meters above the ground plane. The interface cables and equipment positioning were varied within limits of reasonable applications to determine the position produced maximum conducted emissions.

Conducted Emission Limits:

Frequency (MHz)	Quasi Peak (dB μ V)	Average (dB μ V)
0.15 – 0.5	66-56*	56-46*
0.5 – 5.0	56	46
5.0 – 30.0	60	50

3.2. Test Procedures

- a. The EUT was placed 0.4 meter from the conducting wall of the shielding room was kept at least 80 centimeters from any other grounded conducting surface.
- b. Connect EUT to the power mains through a line impedance stabilization network (LISN).
- c. All the support units are connecting to the other LISN.
- d. The LISN provides 50 ohm coupling impedance for the measuring instrument.
- e. The FCC states that a 50 ohm, 50 micro-Henry LISN should be used.
- f. Both sides of AC line were checked for maximum conducted interference.
- g. The frequency range from 150 kHz to 30 MHz was searched.
- h. Set the test-receiver system to Peak Detect Function and Specified Bandwidth with Maximum Hold Mode.

3.3. Typical test Setup

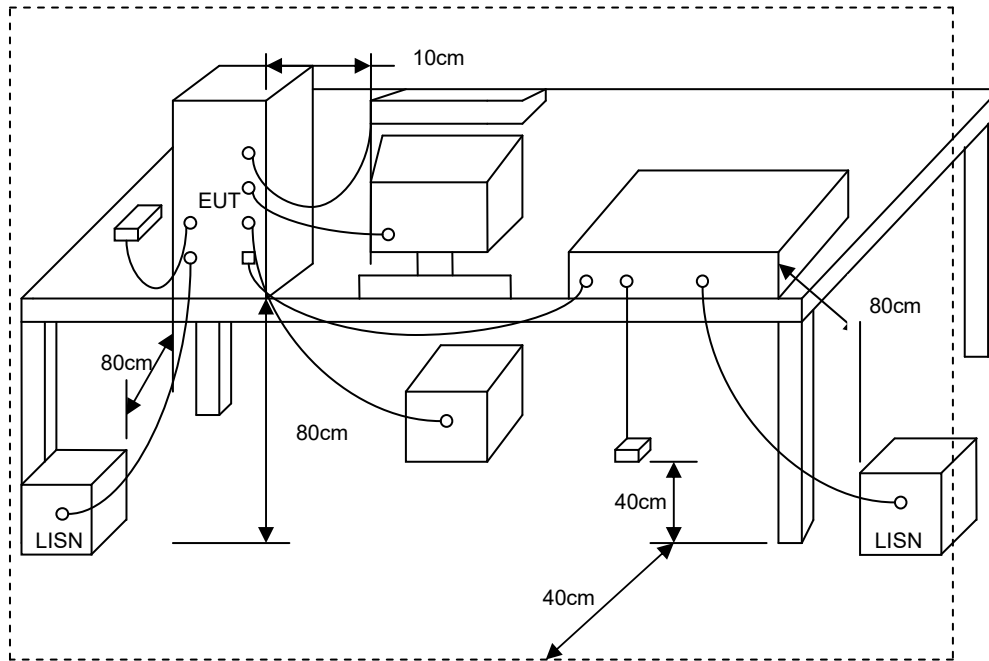

3.4. Measurement Equipment

Instrument	Manufacturer	Model No.	Serial No.	Calibration Date	Valid Date
EMI Receiver	R&S	ESCI3	100821	2019/09/08	2020/09/07
LISN	Schwarzbeck	NSLK 8127	8127-516	2018/09/12	2019/09/11
TWO-LINE V-NETWORK	ROHDE & SCHWARZ	ENV216	102185	2019/05/31	2020/05/30
Software	E3	AUDIX	Version: 8.14.806b	N/A	N/A



3.5. Test Result and Data

Power	: AC 120V	Pol/Phase	: LINE
Test Mode	: Mode 1	Temperature	: 22 °C
Test Date	: Jul.11, 2019	Humidity	: 40 %
Model No.	: 24G2		

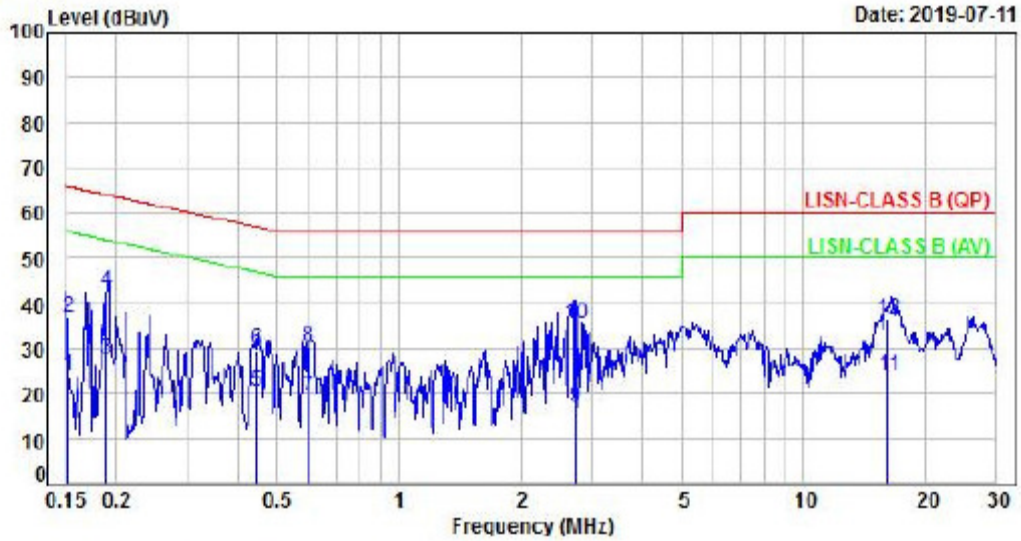

No.	Frequency (MHz)	Factor (dB)	Reading (dBuV)	Level (dBuV)	Limit (dBuV)	Margin (dB)	Detector	P/F
1	0.15	9.92	14.21	24.13	55.94	-31.81	Average	P
2	0.15	9.92	26.89	36.81	65.94	-29.13	QP	P
3	0.19	9.92	17.76	27.68	54.07	-26.39	Average	P
4	0.19	9.92	32.55	42.47	64.07	-21.60	QP	P
5	0.44	9.94	10.71	20.65	47.02	-26.37	Average	P
6	0.44	9.94	19.66	29.60	57.02	-27.42	QP	P
7	0.59	9.95	9.26	19.21	46.00	-26.79	Average	P
8	0.59	9.95	20.43	30.38	56.00	-25.62	QP	P
9	2.74	10.03	6.99	17.02	46.00	-28.98	Average	P
10	2.74	10.03	25.41	35.44	56.00	-20.56	QP	P
11	16.17	10.50	13.33	23.83	50.00	-26.17	Average	P
12	16.17	10.50	26.17	36.67	60.00	-23.33	QP	P

Note: Level=Reading+Factor
Margin=Level-Limit
Factor=(LISN or ISM or Current Probe)Factor + Cable Loss



Power	: AC 120V	Pol/Phase	: NEUTRAL
Test Mode	: Mode 1	Temperature	: 22 °C
Test Date	: Jul.11, 2019	Humidity	: 40 %
Model No.	: 24G2		

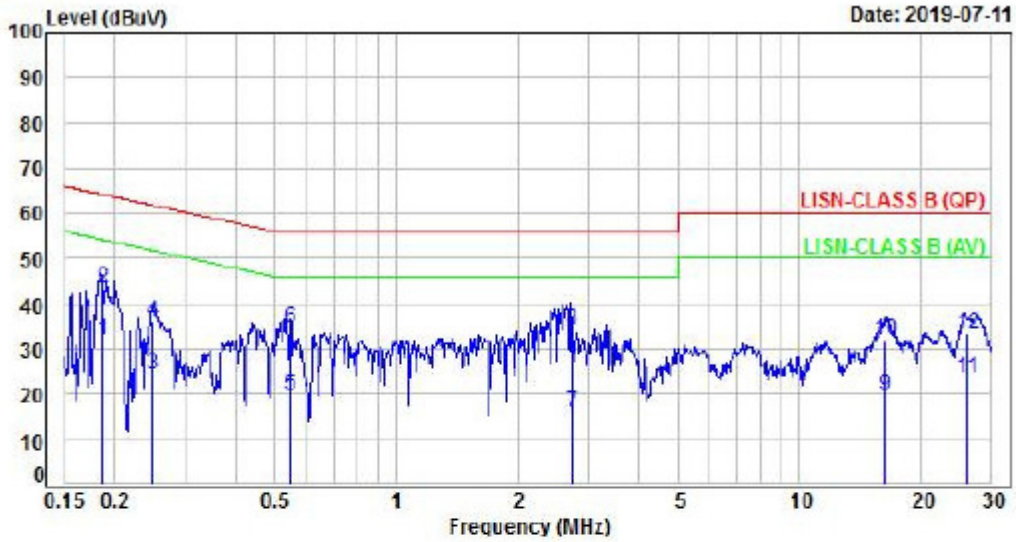

No.	Frequency (MHz)	Factor (dB)	Reading (dBuV)	Level (dBuV)	Limit (dBuV)	Margin (dB)	Detector	P/F
1	0.19	9.95	21.98	31.93	54.15	-22.22	Average	P
2	0.19	9.95	33.35	43.30	64.15	-20.85	QP	P
3	0.25	9.95	14.24	24.19	51.81	-27.62	Average	P
4	0.25	9.95	26.02	35.97	61.81	-25.84	QP	P
5	0.54	9.96	9.93	19.89	46.00	-26.11	Average	P
6	0.54	9.96	24.54	34.50	56.00	-21.50	QP	P
7	2.74	10.05	5.78	15.83	46.00	-30.17	Average	P
8	2.74	10.05	24.12	34.17	56.00	-21.83	QP	P
9	16.32	10.54	9.22	19.76	50.00	-30.24	Average	P
10	16.32	10.54	21.56	32.10	60.00	-27.90	QP	P
11	26.03	10.83	12.81	23.64	50.00	-26.36	Average	P
12	26.03	10.83	22.47	33.30	60.00	-26.70	QP	P

Note: Level=Reading+Factor
Margin=Level-Limit
Factor=(LISN or ISN or Current Probe)Factor + Cable Loss

Test engineer: Peter



3.6. Test Photographs

Front View



Rear View





4. Test of Radiated Emission

4.1. Test Limit

Radiated emissions from 30 MHz to 18,000 MHz were measured according to the methods defines in ANSI C63.4-2014. The EUT was placed on a nonmetallic stand in the Chamber, 0.8 meter above the ground plane. The interface cables and equipment positions were varied within limits of reasonable applications to determine the positions producing maximum radiated emissions.

For unintentional device, according to §15.109, except for Class A digital devices, the field strength of radiated emissions from unintentional radiators at a distance of 3 meters shall not exceed the following values:

Class B Radiated Emission limit at 3m

Frequency (MHz)	Distance Meters	Radiated ($\mu\text{V} / \text{M}$)	Radiated (dB $\mu\text{V} / \text{M}$)
30-88	3	100	40.0
88-216	3	150	43.5
216-960	3	200	46.0
Above 960	3	500	54.0

Frequency (MHz)	Average (dBuV/m)	Peak (dBuV/m)
Above 1000	54	74

Class A Radiated Emission limit at 10m

Frequency (MHz)	Distance Meters	Radiated ($\mu\text{V} / \text{M}$)	Radiated (dB $\mu\text{V} / \text{M}$)
30-88	10	90	39
88-216	10	150	43.5
216-960	10	210	46.4
Above 960	10	300	49.5

Frequency (MHz)	Average (dBuV/m)	Peak (dBuV/m)
Above 1000	60	80

NOTE: (1) The lower limit shall apply at the transition frequencies.

(2) Emission level (dBuV/m) = 20 log Emission level (uV/m).

4.2. Test Procedures

- a. The EUT was placed on a Rota table top 0.8 meter above ground.
- b. The EUT was set 3/10 meters from the interference receiving antenna which was mounted on the top of a variable height antenna tower.
- c. The table was rotated 360 degrees to determine the position of the highest radiation.
- d. The antenna is a half wave dipole and its height is varied between one meter and four meters above ground to find the maximum value of the field strength both horizontal polarization and vertical polarization of the antenna are set to make the measurement.
- e. For each suspected emission the EUT was arranged to its worst case and then tune the antenna tower (from 1 M to 4 M) and turn table (from 0 degree to 360 degrees) to find the maximum reading.
- f. Set the test-receiver system to Peak Detect Function and specified bandwidth with Maximum Hold Mode.
- g. If the emission level of the EUT in peak mode was 6 dB lower than the limit specified, then testing will be stopped and peak values of EUT will be reported, otherwise, the emissions which do not have 6 dB margin will be repeated one by one using the quasi-peak method and reported.

4.3. Typical test Setup

Below 1GHz Test Setup

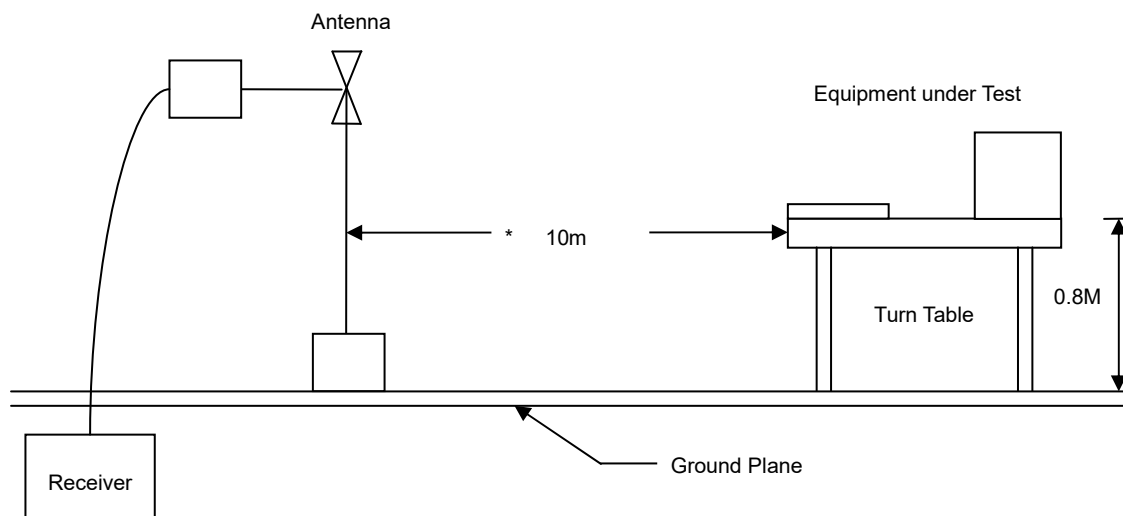

Above 1GHz Test Setup

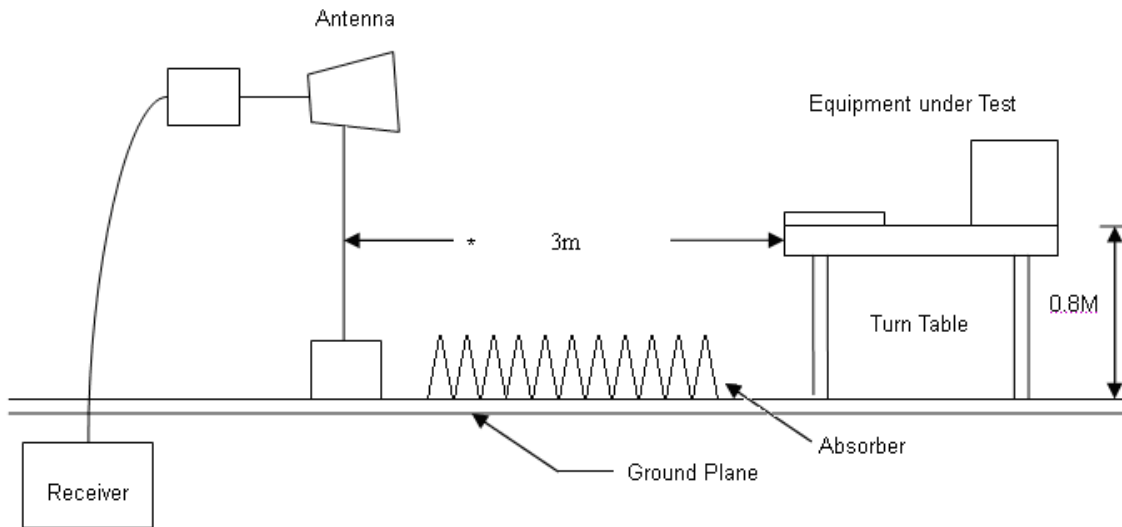

4.4. Measurement Equipment

Instrument	Manufacturer	Model No.	Serial No.	Calibration Date	Valid Date
Bilog Antenna	Sunol	JB1	A020514-1	2019/03/26	2020/03/25
Bilog Antenna	Sunol	JB1	A020514-2	2019/03/20	2020/03/19
EMI Receiver	R&S	ESCI3	101402	2019/03/14	2020/03/13
EMI Receiver	R&S	ESCI7	100963	2019/04/15	2020/04/14
Preamplifier	EM Electronics corp.	EM330	60610	2019/03/08	2020/03/07
Preamplifier	EM Electronics corp.	EM330	60611	2019/02/26	2020/02/25
Horn Antenna	EMCO	3115	31601	2018/09/27	2019/09/26
Spectrum Analyzer	R&S	FSP40	100219	2019/07/03	2020/07/02
Preamplifier	Agilent	8449B	3008A01954	2019/02/23	2020/02/22
Software	E3	AUDIX	Version: 8.14.806b	N/A	N/A



4.5. Test Result and Data (30MHz ~ 1GHz)

Power	: AC 120V	Pol/Phase	: VERTICAL
Test Mode	: Mode 1	Temperature	: 20 °C
Test Date	: Jul.10, 2019	Humidity	: 40 %
Model No.	: 24G2		

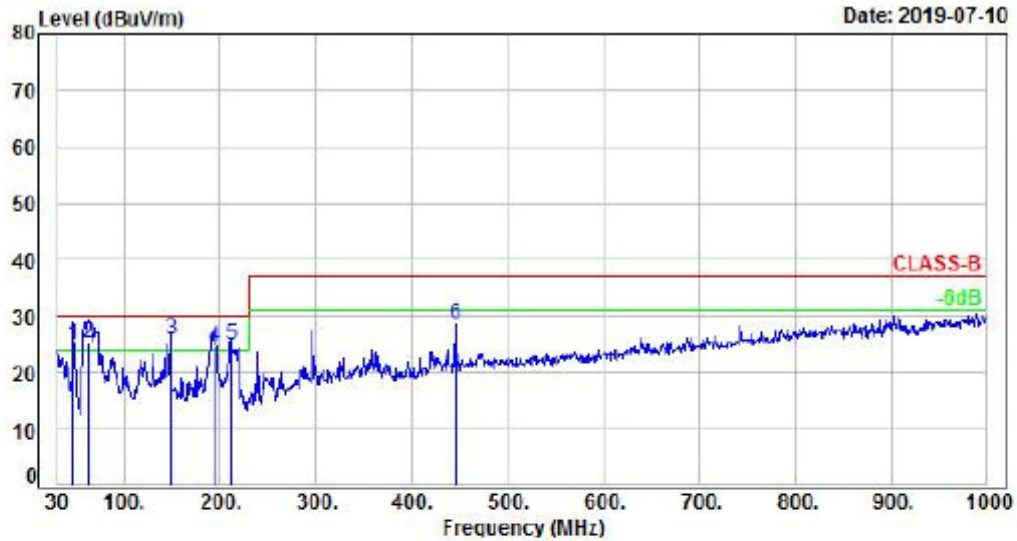

No.	Frequency (MHz)	Factor (dB/m)	Reading (dBuV)	Level (dBuV/m)	Limit (dBuV/m)	Margin (dB)	Detector	Height (cm)	Azimuth (deg)	P/F
1	47.46	-15.50	40.43	24.93	30.00	-5.07	QP	100	303	P
2	62.01	-16.38	41.64	25.26	30.00	-4.74	QP	400	148	P
3	148.34	-10.93	36.69	25.76	30.00	-4.24	QP	100	23	P
4	193.93	-11.32	35.96	24.64	30.00	-5.36	QP	100	12	P
5	211.39	-12.47	37.37	24.90	30.00	-5.10	QP	100	331	P
6	445.16	-4.29	33.00	28.71	37.00	-8.29	Peak	100	243	P

Note: Level=Reading+Factor
Margin=Level-Limit
Factor=Antenna Factor + cable loss - Amplifier Factor



Power	: AC 120V	Pol/Phase	: HORIZONTAL
Test Mode	: Mode 1	Temperature	: 20 °C
Test Date	: Jul.10, 2019	Humidity	: 40 %
Model No.	: 24G2		

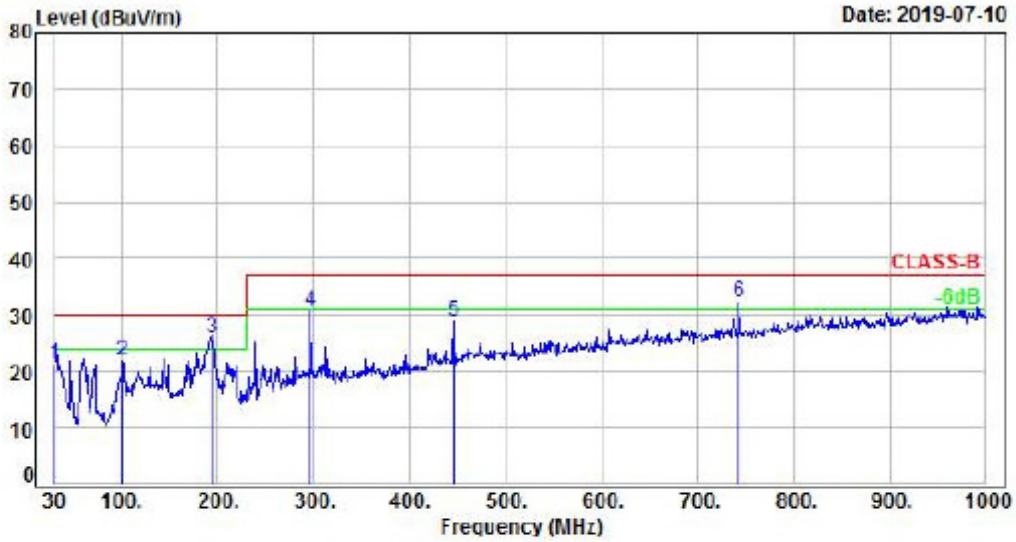

No.	Frequency (MHz)	Factor (dB/m)	Reading (dBuV)	Level (dBuV/m)	Limit (dBuV/m)	Margin (dB)	Detector	Height (cm)	Azimuth (deg)	P/F
1	30.40	-2.63	23.84	21.21	30.00	-8.79	QP	100	323	P
2	100.81	-12.49	34.35	21.86	30.00	-8.14	Peak	400	81	P
3	194.90	-10.59	36.35	25.76	30.00	-4.24	QP	400	11	P
4	296.75	-8.32	39.05	30.73	37.00	-6.27	Peak	400	289	P
5	445.16	-3.89	32.90	29.01	37.00	-7.99	Peak	400	339	P
6	742.95	1.74	30.60	32.34	37.00	-4.66	QP	100	148	P

Note: Level=Reading+Factor
 Margin=Level-Limit
 Factor=Antenna Factor + cable loss - Amplifier Factor

Test engineer: Peter



4.6. Test Result and Data (1GHz ~ 18GHz)

Power	: AC 120V	Pol/Phase	: VERTICAL
Test Mode	: Mode 1	Temperature	: 20 °C
Test Date	: Jul.11, 2019	Humidity	: 40 %
Model No.	: 24G2		

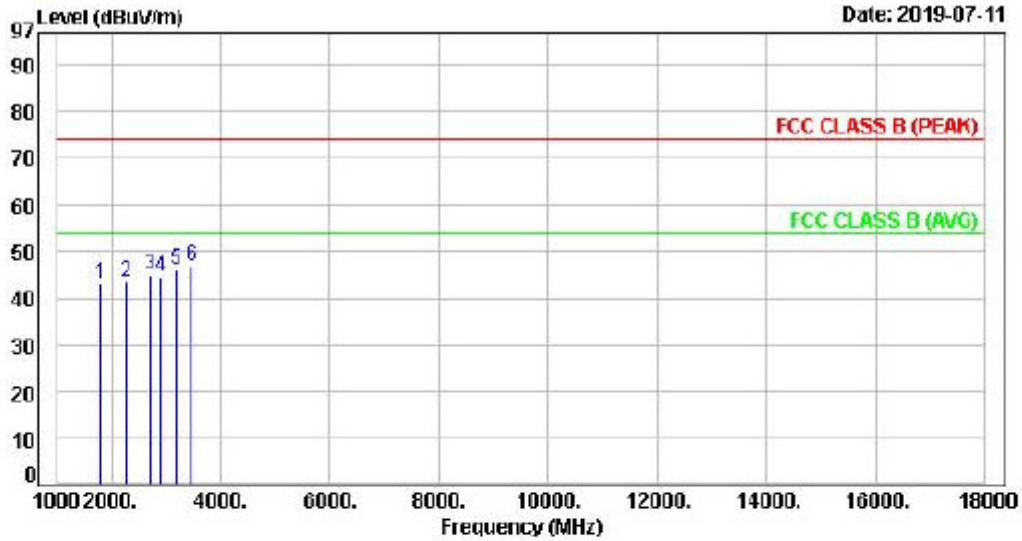

No.	Frequency [MHz]	Factor [dB/n]	Reading [dBuV]	Level (dBuV/m)	Limit (dBuV/m)	Margin (dB)	Detector	Height (cm)	Azimuth (deg)	P/F
1	1799.00	-5.82	49.01	43.19	74.00	-30.81	Peak	400	0	P
2	2258.00	-3.47	46.97	43.50	74.00	-30.50	Peak	400	0	P
3	2717.00	-1.89	46.75	44.86	74.00	-29.14	Peak	400	0	P
4	2904.00	-0.97	45.62	44.65	74.00	-29.35	Peak	400	0	P
5	3176.00	0.56	45.36	45.92	74.00	-28.08	Peak	400	0	P
6	3465.00	1.43	45.33	46.76	74.00	-27.24	Peak	400	0	P

Note: Level=Reading+Factor
Margin=Level-Limit
Factor=Antenna Factor + cable loss - Amplifier Factor



Power	: AC 120V	Pol/Phase	: HORIZONTAL
Test Mode	: Mode 1	Temperature	: 20 °C
Test Date	: Jul.11, 2019	Humidity	: 40 %
Model No.	: 24G2		

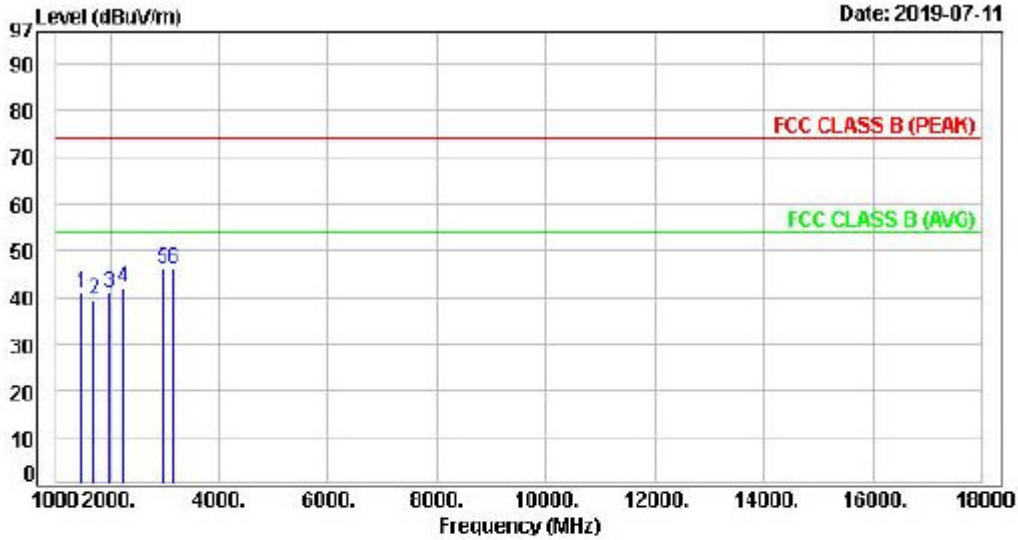

No.	Frequency (MHz)	Factor (dB/m)	Reading (dBUV)	Level (dBUV/m)	Limit (dBUV/m)	Margin (dB)	Detector	Height (cm)	Azimuth (deg)	P/F
1	1493.00	-7.43	48.31	40.88	74.00	-33.12	Peak	100	0	P
2	1697.00	-6.19	45.70	39.51	74.00	-34.49	Peak	100	0	P
3	1986.00	-4.11	44.90	40.79	74.00	-33.21	Peak	100	0	P
4	2224.00	-3.61	45.54	41.93	74.00	-32.07	Peak	100	0	P
5	2955.00	-0.61	46.74	46.13	74.00	-27.87	Peak	100	0	P
6	3159.00	0.50	45.43	45.93	74.00	-28.07	Peak	100	0	P

Note: Level=Reading+Factor
 Margin=Level-Limit
 Factor=Antenna Factor + cable loss - Amplifier Factor

Test engineer: Peter



4.7. Test Photographs (30MHz ~ 1GHz)

Front View



Rear View





4.8. Test Photographs (1GHz ~ 18GHz)

Front View



Rear View

