



EMC TEST REPORT

Authorized under Declaration of Conformity

According to

EN 55032: 2012+AC 2013 (Class B)	EN 55024:2010+1:2015
EN 61000-3-2 : 2014	IEC 61000-4-2 : 2008
EN 61000-3-3 : 2013	IEC 61000-4-3 : 2006+A1:2007+A2:2010
CISPR 32 : 2015	IEC 61000-4-4 : 2012
AS/NZS CISPR 32 : 2013	IEC 61000-4-5 : 2017
	IEC 61000-4-6 : 2013
	IEC 61000-4-8 : 2009
	IEC 61000-4-11 : 2017

Applicant : TPV Electronics (Fujian) Co., Ltd.
Address : Rongqiao Economic and Technological
Development Zone, Fuqing City, Fujian Province,
P.R. China
Equipment : LCD Monitor
Model No. : *2590*****, 250LM00007

I HEREBY CERTIFY THAT :

The sample was received on Oct 19, 2017 and the testing was carried out on Oct 23, 2017 at CerpPASS Technology Corp. The test result refers exclusively to the test presented test model / sample. Without written approval of CerpPASS Technology Corp., the test report shall not be reproduced except in full.



EMC TEST REPORT

Issued by:

CerpPASS Technology (Suzhou) Co.,Ltd

No.66,Tangzhuang Road, Suzhou Industrial Park, Jiangsu 215006, China

Tel:86-512-6917-5888

Fax:86-512-6917-5666

The test record, data evaluation & Equipment Under Test configurations represented herein are true and accurate accounts of the measurements of the samples EMC characteristics under the conditions specified in this report.

The above equipment was tested by CerpPASS Technology Corp. for compliance with the requirements of technical standards specified above under the EMC Directive. The results of testing in this report apply only to the product/system, which was tested. Other similar equipment will not necessarily produce the same results due to production tolerance and measurement uncertainties

Approved by:

Miro Chueh
EMC/RF B.U. Manager

Laboratory Accreditation:

CerpPASS Technology Corporation Test Laboratory

TAF LAB Code:	1439
----------------------	-------------

CerpPASS Technology(SuZhou) Co., Ltd.

CNAS LAB Code:	L5515
-----------------------	--------------



Contents

1. Summary of Test Procedure and Test Results	6
2. Immunity Testing Performance Criteria Definition	7
3. Test Configuration of Equipment under Test	8
3.1. Feature of Equipment under Test.....	8
3.2. Test Mode and Test Manner.....	9
3.3. Description of Support Unit.....	11
3.4. General Information of Test.....	12
3.5. Measurement Uncertainty.....	13
4. Test of Conducted Emission.....	15
4.1. Test Limit.....	15
4.2. Test Procedures.....	18
4.3. Typical Test Setup.....	18
4.4. Measurement Equipment.....	19
4.5. Test Data and Result.....	20
4.6. Test Photographs.....	37
5. Test of Radiated Emission	38
5.1. Test Limit.....	38
5.2. Test Procedures.....	41
5.3. Typical Test Setup.....	41
5.4. Measurement Equipment.....	42
5.5. Test Result and Data (30MHz ~ 1000MHz).....	43
5.6. Test Result and Data (1000MHz ~ 6000MHz).....	59
5.7. Test Photographs (30MHz ~ 1000MHz).....	75
5.8. Test Photographs (1000MHz ~ 6000MHz).....	76
6. Harmonics Test	77
6.1. Limits Of Harmonics Current Measurement.....	77
6.2. Measurement equipment.....	78
6.3. Test Result and Data.....	79
6.4. Test Photographs.....	81
7. Voltage Fluctuations Test	82
7.1. Test Procedure.....	82
7.2. Measurement equipment.....	82
7.3. Test Result and Data.....	83
7.4. Test Photographs.....	85
8. Electrostatic Discharge Immunity Test	86
8.1. Test Procedure.....	86
8.2. Test Setup for Tests Performed in Laboratory.....	87
8.3. Test Severity Levels.....	88
8.4. Measurement equipment.....	88
8.5. Test Result and Data.....	89
8.6. Test Photographs.....	90



9. Radio Frequency electromagnetic field immunity test.....91
9.1. Test Procedure 91
9.2. Test Severity Levels 92
9.3. Measurement equipment 92
9.4. Test Result and Data 93
9.5. Test Photographs 94

10. Electrical Fast Transient/ Burst Immunity Test95
10.1. Test Procedure 95
10.2. Test Severity Levels 96
10.3. Measurement equipment 96
10.4. Test Result and Data 97
10.5. Test Photographs 98

11. Surge Immunity Test99
11.1. Test Procedure 99
11.2. Test Severity Level 100
11.3. Measurement equipment 100
11.4. Test Result and Data 101
11.5. Test Photographs 102

12. Conduction Disturbances induced by Radio-Frequency Fields..... 103
12.1. Test Procedure 103
12.2. Test Severity Levels 104
12.3. Measurement equipment 104
12.4. Test Result and Data 105
12.5. Test Photographs 106

13. Power Frequency Magnetic Field Immunity Tests 107
13.1. Test Setup 107
13.2. Test Severity Levels 107
13.3. Measurement equipment 107
13.4. Test Result and Data 108
13.5. Test Photographs 109

14. Voltage Dips and Voltage Interruptions Immunity Test Setup 110
14.1. Test Conditions 110
14.2. Measurement equipment 110
14.3. Test Result and Data 111
14.4. Test Photographs 112

15. Photographs of EUT 113



1. Summary of Test Procedure and Test Results

EMISSION [EN55032: 2012+AC 2013]			
Standard	Item	Result	Remarks
EN55032: 2012+AC 2013 AS/NZS CISPR 32 : 2013 CISPR 32 : 2015	Conducted (Power Port)	PASS	Meet Class B Limit Minimum passing margin(AV) is -8.63 dB at 1.3619 MHz
	Conducted (Telecom port)	N/A	N/A
	Radiated	PASS	Meets Class B Limit Minimum passing margin(Peak) is -4.17 dB at 952.4700 MHz
EN 61000-3-2: 2014	Harmonic current emissions	PASS	Meet Class D Limit
EN61000-3-3:2013	Voltage fluctuations & flicker	PASS	Meets the requirements

IMMUNITY [EN 55024:2010+1:2015]			
Standard	Item	Result	Remarks
IEC 61000-4-2: 2008	ESD	PASS	Meets the requirements of Performance Criterion A
IEC 61000-4-3: 2006+A1:2007+A2:2010	RS	PASS	Meets the requirements of Performance Criterion A
IEC 61000-4-4: 2012	EFT	PASS	Meets the requirements of Performance Criterion A
IEC 61000-4-5:2017	Surge	PASS	Meets the requirements of Performance Criterion A
IEC 61000-4-6:2013	CS	PASS	Meets the requirements of Performance Criterion A
IEC 61000-4-8:2009	PFMF	PASS	Meets the requirements of Performance Criterion A
IEC 61000-4-11:2017	Voltage dips & voltage variations	PASS	Meets the requirements of Voltage Dips: 1) >95% reduction Performance Criterion B 2) 30% reduction Performance Criterion B Voltage Interruptions: 1) >95% reduction Performance Criterion C



2. Immunity Testing Performance Criteria Definition

Criteria A:	The apparatus shell continues to operate as intended without operator intervention. No degradation of performance or loss of function is allowed below a performance level specified by the manufacturer, when the apparatus is used as intended. The performance level may be replaced by a permissible loss of performance. If the manufacturer does not specify the minimum performance level or the permissible performance loss, then either of these may be derived from the product description and documentation, and by what the user may reasonably expect from the equipment if used as intended.
Criteria B:	After test, the apparatus shell continues to operate as intended without operator intervention. No degradation of performance or loss of function is allowed, after the application of the phenomenon below a performance level specified by the manufacturer, when the apparatus is used as intended. The performance level may be replaced by a permissible loss of performance. During the test, degradation of performance is however allowed. However, no change of operating state if stored data is allowed to persist after the test. If the manufacturer does not specify the minimum performance level or the permissible performance loss, then either of these may be derived from the product description and documentation, and by what the user may reasonably expect from the equipment if used as intended.
Criteria C:	Temporary loss of function is allowed, provided the functions is self-recoverable or can be restored by the operation of controls by the user in accordance with the manufacturer instructions. Functions, and/or information stored in non-volatile memory, or protected by a battery backup, shall not be lost.



3. Test Configuration of Equipment under Test

3.1. Feature of Equipment under Test

LCD Monitor	Model No.:	*2590*****, 250LM00007
EUT Highest Frequency:	350MHz	
EUT Power Rating:	Input: 100-240V~, 50/60Hz 3Pin Power Port	
AC Power Cord Type:	Non-shielded, 1.2m&1.5m&1.8m	

I/O PORT:

I/O PORT TYPE	Q'TY
1). HDMI Port	2
2). VGA Port	1
3). DISPLAY Port	1
4). USB Port	5
5). Audio Port	2
6). Power Port	1



3.2. Test Mode and Test Manner

- a. During testing, the interface cables and equipment positions were varied according to Standard Europe Standard.
- b. An executive program, "MyHwin" under Win 8, which generates a complete line of continuously repeating "H" pattern was used as the test software.
The program was executed as follows:
 - 1. Turn on the power of all equipment.
 - 2. The EUT reads the test program from the hard disk drive and runs it.
 - 3. PC sends "H" messages to the EUT, and the monitor displays "H" patterns on the screen.
 - 4. Run the Colour bars.
 - 5. Repeat the steps from 2 to 4.
- c. The complete test system included Computer, DVD, USB Keyboard, USB Mouse, Earphone, HDD and EUT for EMC test.

The pre-test for CE/ RE modes

Test Mode 1	Full system (Display mode 1920*1080@144Hz) Signal from PC for Horizontal (230V/50Hz)
Test Mode 2	Full system (Display mode 1280*1024@75Hz) Signal from PC for Horizontal (230V/50Hz)
Test Mode 3	Full system (Display mode 640*480@60Hz) Signal from PC for Horizontal (230V/50Hz)
Test Mode 4	Full system (Display mode 1920*1080@144Hz) Signal from PC for Vertical (230V/50Hz)
Test Mode 5	Full system (VGA mode 1920*1080@144Hz) Signal from PC for Horizontal (230V/50Hz)
Test Mode 6	Full system (VGA mode 1280*1024@75Hz) Signal from PC for Horizontal (230V/50Hz)
Test Mode 7	Full system (VGA mode 640*480@60Hz) Signal from PC for Horizontal (230V/50Hz)
Test Mode 8	Full system (VGA mode 1920*1080@60Hz) Signal from PC for Vertical (230V/50Hz)
Test Mode 9	Full system (HDMI 1 mode 1920*1080@144Hz) Signal from PC for Horizontal (230V/50Hz)
Test Mode 10	Full system (HDMI 1 mode 1280*1024@75Hz) Signal from PC for Horizontal (230V/50Hz)
Test Mode 11	Full system (HDMI 1 mode 640*480@60Hz) Signal from PC for Horizontal (230V/50Hz)



- Test Mode 12 Full system (HDMI 1 mode 1920*1080@144Hz) Signal from PC for Vertical (230V/50Hz)
- Test Mode 13 Full system (HDMI 1 mode 1080P) Signal from DVD for Horizontal (230V/50Hz)
- Test Mode 14 Full system (HDMI 2 mode 1920*1080@144Hz) Signal from PC for Horizontal (230V/50Hz)
- Test Mode 15 Full system (HDMI 2 mode 1280*1024@75Hz) Signal from PC for Horizontal (230V/50Hz)
- Test Mode 16 Full system (HDMI 2 mode 640*480@60Hz) Signal from PC for Horizontal (230V/50Hz)
- Test Mode 17 Full system (HDMI 2 mode 1920*1080@144Hz) Signal from PC for Vertical (230V/50Hz)
- Test Mode 18 Full system (HDMI 2 mode 1080P) Signal from DVD for Horizontal (230V/50Hz)
- Test Mode 19 Full system (Display mode 1920*1080@144Hz) Signal from PC for Horizontal (110V/60Hz)
- Test Mode 20 Full system (VGA mode 1920*1080@144Hz) Signal from PC for Horizontal (110V/60Hz)
- Test Mode 21 Full system (HDMI 1 mode 1920*1080@144Hz) Signal from PC for Horizontal (110V/60Hz)
- Test Mode 22 Full system (HDMI 2 mode 1920*1080@144Hz) Signal from PC for Horizontal (110V/60Hz)

“Test mode 1,5,9,14,19,20,21,22” were reported as final data.

The pre-test for Harmonic/Flicker/EMS modes

- Test Mode 1 Full system (Display mode 1920*1080@144Hz) Signal from PC for Horizontal
- Test Mode 2 Full system (VGA mode 1920*1080@144Hz) Signal from PC for Horizontal
- Test Mode 3 Full system (HDMI 1 mode 1920*1080@144Hz) Signal from PC for Horizontal
- Test Mode 4 Full system (HDMI 2 mode 1920*1080@144Hz) Signal from PC for Horizontal

“Test mode 1,2,3,4” were reported as final data.



3.3. Description of Support Unit

No.	Device	Manufacturer	Model No.	Description
1	Computer	HP	HP Compaq Elite 8200 MTPC	Non-Shielded ,1.8m (R33001)
2	DVD	PIONEER	DV-600AV-S	N/A
3	USB Keyboard	DELL	SK-8115	T3A002
4	USB Mouse	DELL	G0K02XYK	R41108
5	Earphone	Edifier	N/A	N/A
6	HDD	WD	WDBPCK5000ABK-01	N/A
7	HDD	WD	WDBPCK5000ABK-02	N/A
8	HDD	WD	WDBPCK5000ABK-03	N/A
9	HDD	WD	WDBPCK5000ABK-04	N/A

No.	Cable	Quantity	Description
A	HDMI Cable	1	Shielded, 1.2m&1.5m&1.8m
B	USB Cable	1	Shielded, 1.8m
C	HDMI Cable	1	Shielded, 1.2m&1.5m&1.8m
D	VGA Cable	1	Shielded, 1.2m&1.5m&1.8m, with two ferrites core bonded
E	DISPLAY Cable	1	Shielded, 1.2m&1.5m&1.8m
F	Audio Cable	1	Shielded, 1.2m&1.5m&1.8m, with two ferrites core bonded
G	Audio Cable	1	Non-Shielded, 1.8m
H	USB Cable	1	Shielded, 0.6m
I	USB Cable	1	Shielded, 0.6m
J	USB Cable	1	Shielded, 0.6m
K	USB Cable	1	Shielded, 0.6m
L	USB Cable	1	Shielded, 1.2m
M	USB Cable	1	Shielded, 1.8m, with one ferrites core bonded

**3.4. General Information of Test**

<input type="checkbox"/>	Test Site	Cerpass Technology Corporation Address: No.10, Ln. 2, Lianfu St., Luzhu Dist., Taoyuan City 33848, Taiwan (R.O.C.) Tel:+886-3-3226-888 Fax:+886-3-3226-881 Address: No.68-1, Shihbachongsi, Shihding Township, New Taipei City 223, Taiwan, R.O.C. Tel: +886-2-2663-8582
	FCC	TW1079, TW1061
	IC	4934E-1, 4934E-2
	VCCI	T-2205 for Telecommunication Test C-4663 for Conducted emission test R-4399, R-4218 for Radiated emission test G-812, G-813 for radiated disturbance above 1GHz
<input checked="" type="checkbox"/>	Test Site	Cerpass Technology (Suzhou) Co.,Ltd Address: No.66,Tangzhuang Road, Suzhou Industrial Park, Jiangsu 215006, China Tel: +86-512-6917-5888 Fax: +86-512-6917-5666
	IC	7290A-1, 7290A-2
	VCCI	T-1945 for Telecommunication Test C-2919 for Conducted emission test R-2670 for Radiated emission test G-227 for radiated disturbance above 1GHz
Frequency Range Investigated:		Conducted: from 150kHz to 30 MHz Radiation: from 30 MHz to 6000MHz
Test Distance :		The test distance of radiated emission below 1GHz from antenna to EUT is 10 M. The test distance of radiated emission above 1GHz from antenna to EUT is 3 M.



3.5. Measurement Uncertainty

Where relevant, the following measurement uncertainty levels have been estimated for tests performed on the EUT as specified in CISPR 16-4-2:

Measurement	Frequency	Uncertainty
Conducted emissions(LINE)	9KHz-30MHz	+/- 0.7738 dB
Conducted emissions(NEUTRAL)	9KHz-30MHz	+/- 0.7886 dB

Measurement	Polarity	Frequency	Uncertainty
Radiated emissions (below 1GHz)	H	30MHz ~ 200MHz	+/- 3.8909dB
		200MHz ~1000MHz	+/- 3.6555dB
	V	30MHz ~ 200MHz	+/- 3.8948dB
		200MHz ~1000MHz	+/- 3.6538dB
Radiated emissions (above 1GHz)	H	1000MHz ~18000MHz	+/- 3.8948 dB
		18000MHz ~40000MHz	+/-3.8844dB
	V	1000MHz ~18000MHz	+/- 3.8906dB
		18000MHz ~40000MHz	+/- 3.8744dB

Measurement	Uncertainty
ESD—Rise time tr	10%
ESD—Peak current Ip	6%
ESD—Current at 30 ns	6%
ESD—Current at 60 ns	6%
ESD- Charging voltage	1%
RS above 1GHz	±2.37dB
RS under 1GHz	±3.83dB
EFT—Rise time tr	4%
EFT—Peak current Ip	4%
EFT—Current	4%
Surge—Rise time tr	4%



Surge—Peak current I_p	4%
Surge—Current	4%
CS-CND	$\pm 0.80\text{dB}$
CS-Clamp	$\pm 1.06\text{dB}$

This uncertainty represents an expanded uncertainty expressed at approximately the 95% confidence level using a coverage factor of $k=2$.

Consistent with industry standard (e.g. CISPR 22: 2008, clause 11, Measurement Uncertainty) determining compliance with the limits shall be based on the results of the compliance measurement. Consequently the measured emissions being less than the maximum allowed emission result in this being a compliant test or passing test.



4. Test of Conducted Emission

4.1. Test Limit

Conducted Emissions were measured from 150 kHz to 30 MHz with a bandwidth of 9 kHz and return leads of the EUT according to the methods defined in European Standard EN 55032.

Table A.8 – Requirements for conducted emissions from the AC mains power ports of Class A equipment

Applicable to				
1. AC mains power ports (3.1.1)				
Table clause	Frequency range MHz	Coupling device (see Table A.7)	Detector type / bandwidth	Class A limits dB(μ V)
A8.1	0,15 – 0,5	AMN	Quasi Peak / 9 kHz	79
	0,5 – 30			73
A8.2	0,15 – 0,5	AMN	Average / 9 kHz	66
	0,5 – 30			60

NOTE Apply A8.1 and A8.2 across the entire frequency range.

Table A.9 – Requirements for conducted emissions from the AC mains power ports of Class B equipment

Applicable to				
1. AC mains power ports (3.1.1)				
Table clause	Frequency range MHz	Coupling device (see Table A.7)	Detector type / bandwidth	Class B limits dB(μ V)
A9.1	0,15 – 0,5	AMN	Quasi Peak / 9 kHz	66 – 56
	0,5 – 5			56
	5 – 30			60
A9.2	0,15 – 0,5	AMN	Average / 9 kHz	56 – 46
	0,5 – 5			46
	5 – 30			50

NOTE Apply A9.1 and A9.2 across the entire frequency range.

**Table A.10 – Requirements for asymmetric mode conducted emissions from Class A equipment**

Applicable to					
1. wired network ports (3.1.30)					
2. optical fibre ports (3.1.24) with metallic shield or tension members					
3. antenna ports (3.1.3)					
Table clause	Frequency range MHz	Coupling device (see Table A.7)	Detector type / bandwidth	Class A voltage limits dB(μV)	Class A current limits dB(μA)
A10.1	0,15 – 0,5	AAN	Quasi Peak / 9 kHz	97 – 87	n/a
	0,5 – 30			87	
	0,15 – 0,5	AAN	Average / 9 kHz	84 – 74	
	0,5 – 30			74	
A10.2	0,15 – 0,5	CVP and current probe	Quasi Peak / 9 kHz	97 – 87	53 – 43
	0,5 – 30			87	43
	0,15 – 0,5	CVP and current probe	Average / 9 kHz	84 – 74	40 – 30
	0,5 – 30			74	30
A10.3	0,15 – 0,5	Current Probe	Quasi Peak / 9 kHz	n/a	53 – 43
	0,5 – 30				43
	0,15 – 0,5	Current Probe	Average / 9 kHz		40 – 30
	0,5 – 30				30
NOTE 1 The choice of coupling device and measurement procedure is defined in Annex C.					
NOTE 2 AC mains power ports shall meet the limits given in Table A.8.					
NOTE 3 The test shall cover the entire frequency range.					
NOTE 4 The application of the voltage and/or current limits is dependent on the measurement procedure used. Refer to Table C.1 for applicability.					
NOTE 5 Testing is required at only one EUT supply voltage and frequency.					
NOTE 6 Applicable to ports listed above and intended to connect to cables longer than 3 m.					

**Table A.11 – Requirements for asymmetric mode conducted emissions from Class B equipment**

Applicable to					
1. wired network ports (3.1.30) 2. optical fibre ports (3.1.24) with metallic shield or tension members 3. broadcast receiver tuner ports (3.1.8) 4. antenna ports (3.1.3)					
Table clause	Frequency range MHz	Coupling device (see Table A.7)	Detector type / bandwidth	Class B voltage limits dB(μV)	Class B current limits dB(μA)
A11.1	0,15 – 0,5	AAN	Quasi Peak / 9 kHz	84 – 74	n/a
	0,5 – 30			74	
	0,15 – 0,5	AAN	Average / 9 kHz	74 – 64	
	0,5 – 30			64	
A11.2	0,15 – 0,5	CVP and current probe	Quasi Peak / 9 kHz	84 – 74	40 – 30
	0,5 – 30			74	30
	0,15 – 0,5	CVP and current probe	Average / 9 kHz	74 – 64	30 – 20
	0,5 – 30			64	20
A11.3	0,15 – 0,5	Current Probe	Quasi Peak / 9 kHz	n/a	40 – 30
	0,5 – 30				30
	0,15 – 0,5	Current Probe	Average / 9 kHz		30 – 20
	0,5 – 30				20
NOTE 1 The choice of coupling device and measurement procedure is defined in Annex C.					
NOTE 2 Screened ports including TV broadcast receiver tuner ports are tested with a common-mode impedance of 150 Ω . This is typically accomplished with the screen terminated by 150 Ω to earth.					
NOTE 3 AC mains power ports shall meet the limits given in Table A.9.					
NOTE 4 The test shall cover the entire frequency range.					
NOTE 5 The application of the voltage and/or current limits is dependent on the measurement procedure used. Refer to Table C.1 for applicability.					
NOTE 6 Testing is required at only one EUT supply voltage and frequency.					
NOTE 7 Applicable to ports listed above and intended to connect to cables longer than 3 m.					

4.2. Test Procedures

- a. The EUT was placed on a desk 0.8 meters height from the metal ground plane and 0.4 meter from the conducting wall of the shielding room and it was kept at least 0.8 meters from any other grounded conducting surface.
- b. Connect EUT to the power mains through a Artificial Mains Network (AMN).
- c. All the support units are connecting to the other AMN.
- d. The AMN provides 50 ohm coupling impedance for the measuring instrument.
- e. The CISPR states that a 50 ohm, 50 micro-Henry AMN should be used.
- f. Both sides of AC line were checked for maximum conducted interference.
- g. The frequency range from 150 kHz to 30 MHz was searched
- h. Set the test-receiver system to Peak Detect Function and Specified Bandwidth with Maximum Hold Mode.

4.3. Typical Test Setup

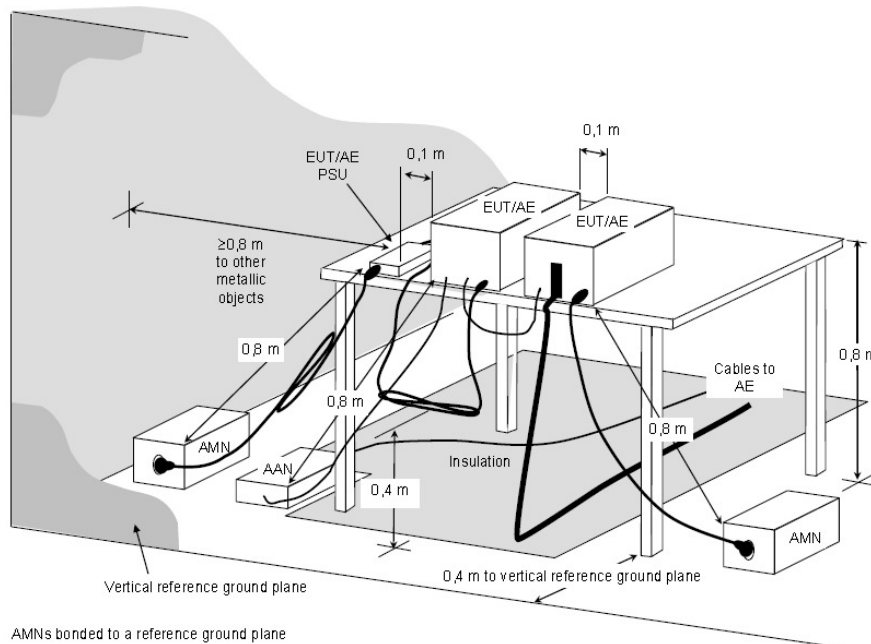

NOTE The 0,8 m distance specified between EUT/AE/PSU and AMN/AAN, is applicable only to the EUT being measured. If the device is AE then it shall be $\geq 0,8$ m.

Figure D.2 – Example measurement arrangement for table-top EUT (Conducted emission measurement – alternative 1)



4.4. Measurement Equipment

Instrument/Ancillary	Manufacturer	Model No.	Serial No.	Calibration Date	Valid Date.
Test Receiver	R&S	ESCI	100565	2017.07.19	2018.07.18
AMN	R&S	ESH2-Z5	100182	2017.08.26	2018.08.25
Two-Line V-Network	R&S	ENV216	100325	/	/
ISN	FCC	FCC-TLISN-T2-02	20379	2017.03.22	2018.03.21
ISN	FCC	FCC-TLISN-T4-02	20380	2017.06.21	2018.06.20
ISN	FCC	FCC-TLISN-T8-02	20381	2016.11.29	2017.11.28
ISN	TESEQ	ISN ST08	30175	2017.08.26	2018.08.25
LISN	FCC	FCC-LISN-50-200-2-02	112087	2017.08.26	2018.08.25
Current Probe	R&S	EZ-17	100303	2017.03.22	2018.03.21
Passive Voltage Probe	R&S	ESH2-Z3	100026	2017.03.22	2018.03.21
Pulse Limiter	R&S	ESH3-Z2	100529	2017.03.22	2018.03.21
Temperature/ Humidity Meter	Zhicheng	ZC1-11	CEP-TH-004	2017.03.28	2018.03.27
EZ-EMC	Fala	Ver CT3A1	N/A	N/A	N/A



4.5. Test Data and Result

4.5.1 Conducted Emission for Power Port Test Data

Test Mode :	Mode 1: Full system (Display mode 1920*1080@144Hz) Signal from PC for Horizontal (230V/50Hz)		
AC Power :	AC 230V/50Hz	Phase :	LINE
Equipment :	LCD Monitor	Model No :	*2590*****
Temperature :	25°C	Humidity :	52%
Pressure(mbar) :	1001	Date:	2017/10/23

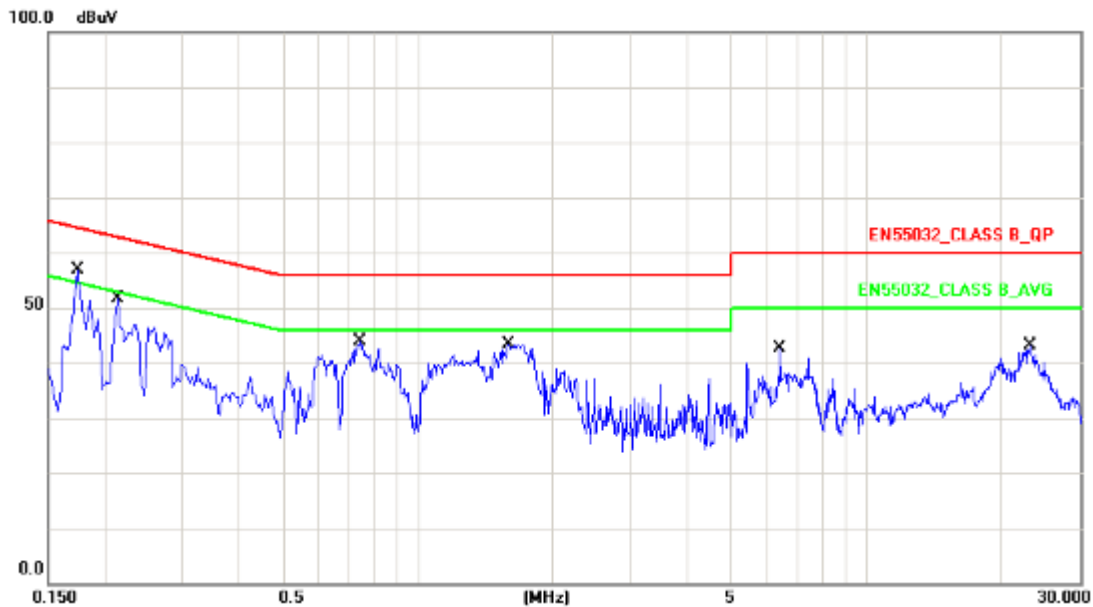

No.	Frequency (MHz)	Factor (dB)	Reading (dBuV)	Level (dBuV)	Limit (dBuV)	Margin (dB)	Detector
1	0.1740	10.13	40.16	50.29	64.76	-14.47	QP
2	0.1740	10.13	27.73	37.86	54.76	-16.90	AVG
3	0.2140	10.12	36.13	46.25	63.04	-16.79	QP
4	0.2140	10.12	25.34	35.46	53.04	-17.58	AVG
5	0.7460	10.14	28.84	38.98	56.00	-17.02	QP
6	0.7460	10.14	19.99	30.13	46.00	-15.87	AVG
7	1.5980	10.17	26.75	36.92	56.00	-19.08	QP
8	1.5980	10.17	18.36	28.53	46.00	-17.47	AVG
9	6.4339	10.25	29.39	39.64	60.00	-20.36	QP
10	6.4339	10.25	27.03	37.28	50.00	-12.72	AVG
11	23.1700	10.40	22.10	32.50	60.00	-27.50	QP
12	23.1700	10.40	15.95	26.35	50.00	-23.65	AVG

Note: Measurement Level = Reading Level + Correct Factor



Test Mode :	Mode 1: Full system (Display mode 1920*1080@144Hz) Signal from PC for Horizontal (230V/50Hz)		
AC Power :	AC 230V/50Hz	Phase :	NEUTRAL
Equipment :	LCD Monitor	Model No :	*2590*****
Temperature :	25°C	Humidity :	52%
Pressure(mbar) :	1001	Date:	2017/10/23

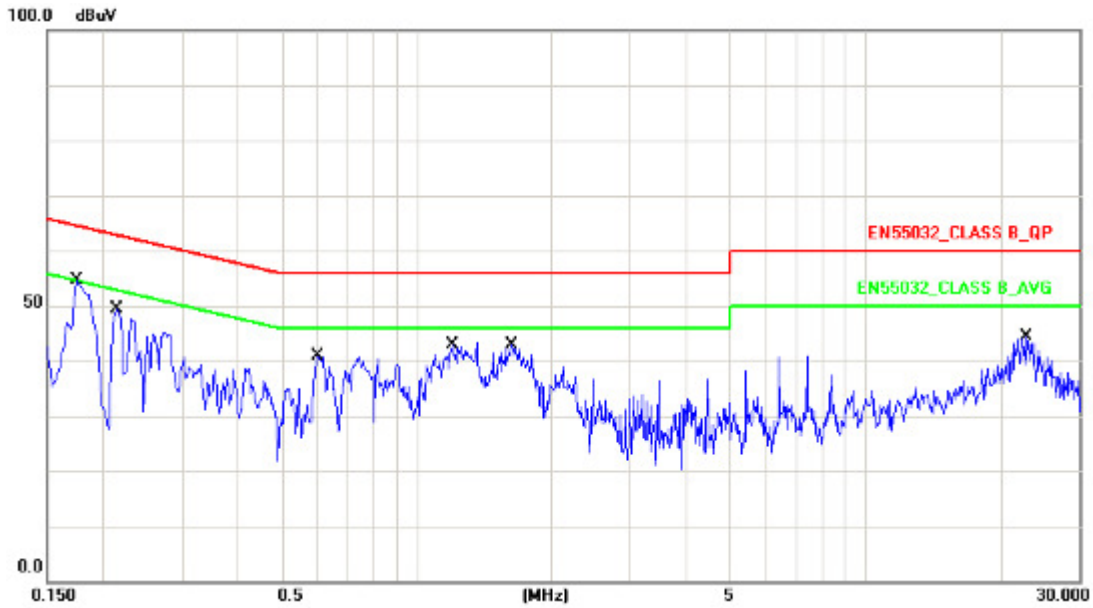

No.	Frequency (MHz)	Factor (dB)	Reading (dBuV)	Level (dBuV)	Limit (dBuV)	Margin (dB)	Detector
1	0.1740	10.13	41.84	51.97	64.76	-12.79	QP
2	0.1740	10.13	27.02	37.15	54.76	-17.61	AVG
3	0.2140	10.13	37.46	47.59	63.04	-15.45	QP
4	0.2140	10.13	24.00	34.13	53.04	-18.91	AVG
5	0.6020	10.16	28.50	38.66	56.00	-17.34	QP
6	0.6020	10.16	23.53	33.69	46.00	-12.31	AVG
7	1.1980	10.18	29.39	39.57	56.00	-16.43	QP
8	1.1980	10.18	22.40	32.58	46.00	-13.42	AVG
9	1.6340	10.18	31.24	41.42	56.00	-14.58	QP
10	1.6340	10.18	25.87	36.05	46.00	-9.95	AVG
11	22.8020	10.39	21.46	31.85	60.00	-28.15	QP
12	22.8020	10.39	16.53	26.92	50.00	-23.08	AVG

Note: Measurement Level = Reading Level + Correct Factor



Test Mode :	Mode 5: Full system (VGA mode 1920*1080@144Hz) Signal from PC for Horizontal (230V/50Hz)		
AC Power :	AC 230V/50Hz	Phase :	LINE
Equipment :	LCD Monitor	Model No :	*2590*****
Temperature :	25°C	Humidity :	52%
Pressure(mbar) :	1001	Date:	2017/10/23

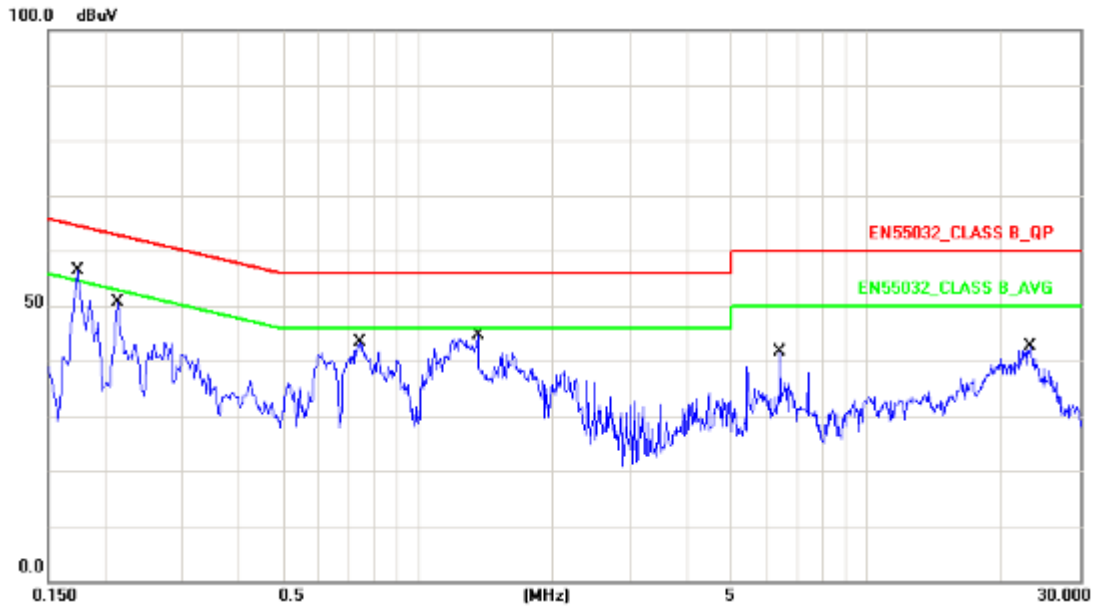

No.	Frequency (MHz)	Factor (dB)	Reading (dBuV)	Level (dBuV)	Limit (dBuV)	Margin (dB)	Detector
1	0.1740	10.13	40.17	50.30	64.76	-14.46	QP
2	0.1740	10.13	27.66	37.79	54.76	-16.97	AVG
3	0.2140	10.12	36.12	46.24	63.04	-16.80	QP
4	0.2140	10.12	25.31	35.43	53.04	-17.61	AVG
5	0.7460	10.14	28.82	38.96	56.00	-17.04	QP
6	0.7460	10.14	19.95	30.09	46.00	-15.91	AVG
7	1.3619	10.16	31.58	41.74	56.00	-14.26	QP
8	1.3619	10.16	27.21	37.37	46.00	-8.63	AVG
9	6.4339	10.25	29.09	39.34	60.00	-20.66	QP
10	6.4339	10.25	26.48	36.73	50.00	-13.27	AVG
11	23.1700	10.40	22.20	32.60	60.00	-27.40	QP
12	23.1700	10.40	16.18	26.58	50.00	-23.42	AVG

Note: Measurement Level = Reading Level + Correct Factor



Test Mode :	Mode 5: Full system (VGA mode 1920*1080@144Hz) Signal from PC for Horizontal (230V/50Hz)		
AC Power :	AC 230V/50Hz	Phase :	NEUTRAL
Equipment :	LCD Monitor	Model No :	*2590*****
Temperature :	25°C	Humidity :	52%
Pressure(mbar) :	1001	Date:	2017/10/23

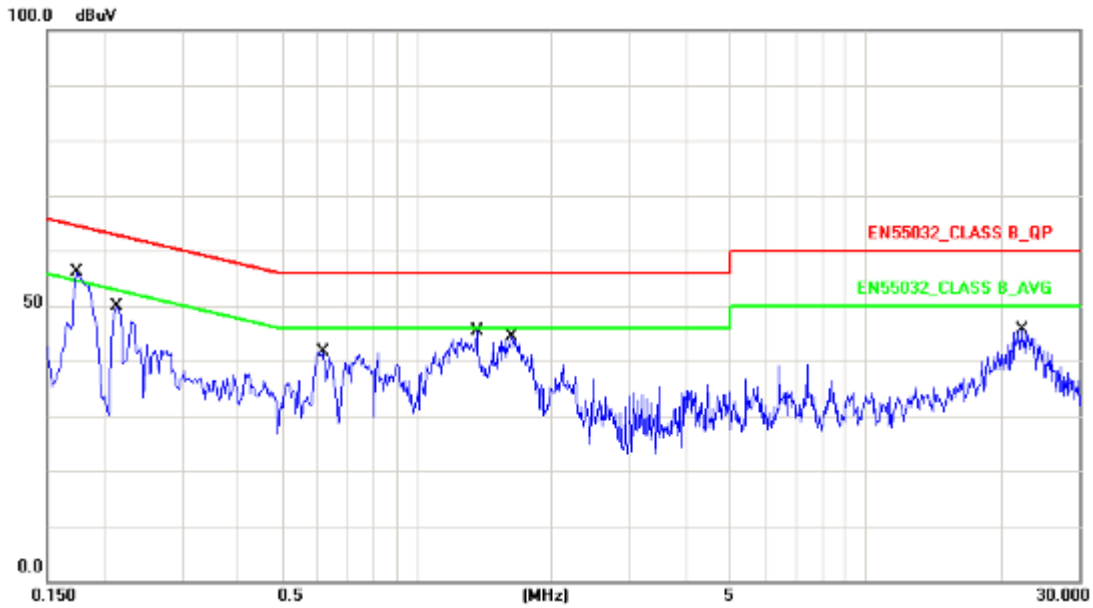

No.	Frequency (MHz)	Factor (dB)	Reading (dBuV)	Level (dBuV)	Limit (dBuV)	Margin (dB)	Detector
1	0.1740	10.13	41.60	51.73	64.76	-13.03	QP
2	0.1740	10.13	26.96	37.09	54.76	-17.67	AVG
3	0.2140	10.13	37.36	47.49	63.04	-15.55	QP
4	0.2140	10.13	23.86	33.99	53.04	-19.05	AVG
5	0.6180	10.16	27.50	37.66	56.00	-18.34	QP
6	0.6180	10.16	11.62	21.78	46.00	-24.22	AVG
7	1.3619	10.18	31.33	41.51	56.00	-14.49	QP
8	1.3619	10.18	27.04	37.22	46.00	-8.78	AVG
9	1.6340	10.18	31.19	41.37	56.00	-14.63	QP
10	1.6340	10.18	25.92	36.10	46.00	-9.90	AVG
11	22.3500	10.39	20.16	30.55	60.00	-29.45	QP
12	22.3500	10.39	14.78	25.17	50.00	-24.83	AVG

Note: Measurement Level = Reading Level + Correct Factor



Test Mode :	Mode 9: Full system (HDMI 1 mode 1920*1080@144Hz) Signal from PC for Horizontal (230V/50Hz)		
AC Power :	AC 230V/50Hz	Phase :	LINE
Equipment :	LCD Monitor	Model No :	*2590*****
Temperature :	25°C	Humidity :	52%
Pressure(mbar) :	1001	Date:	2017/10/23

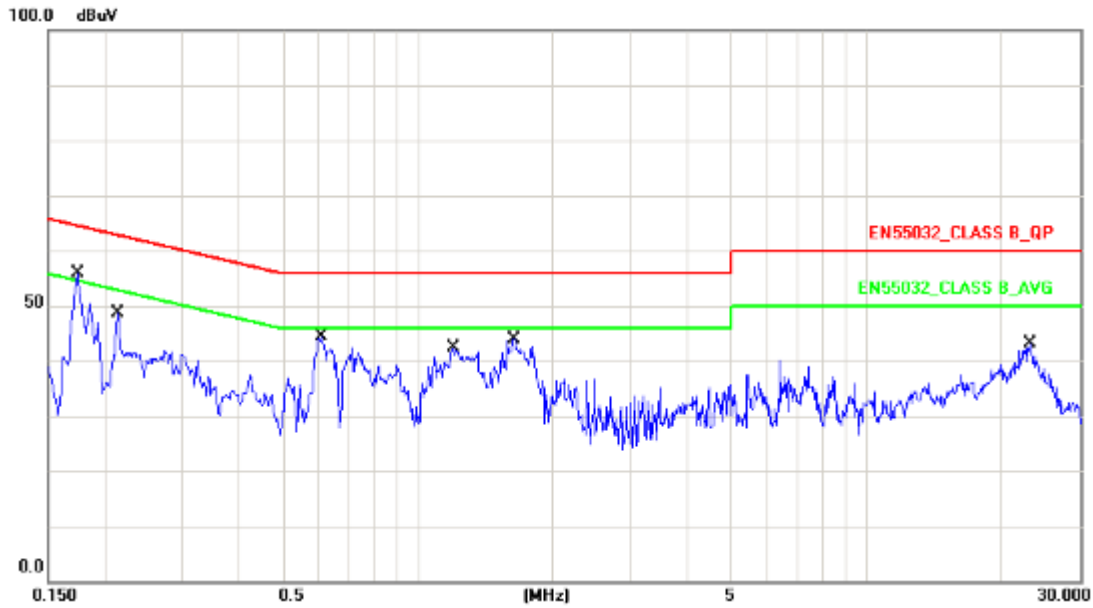

No.	Frequency (MHz)	Factor (dB)	Reading (dBuV)	Level (dBuV)	Limit (dBuV)	Margin (dB)	Detector
1	0.1740	10.13	39.96	50.09	64.76	-14.67	QP
2	0.1740	10.13	27.59	37.72	54.76	-17.04	AVG
3	0.2140	10.12	36.24	46.36	63.04	-16.68	QP
4	0.2140	10.12	25.28	35.40	53.04	-17.64	AVG
5	0.6100	10.15	29.40	39.55	56.00	-16.45	QP
6	0.6100	10.15	20.30	30.45	46.00	-15.55	AVG
7	1.2020	10.16	29.81	39.97	56.00	-16.03	QP
8	1.2020	10.16	23.00	33.16	46.00	-12.84	AVG
9	1.6380	10.17	29.72	39.89	56.00	-16.11	QP
10	1.6380	10.17	24.19	34.36	46.00	-11.64	AVG
11	23.1700	10.40	22.49	32.89	60.00	-27.11	QP
12	23.1700	10.40	16.71	27.11	50.00	-22.89	AVG

Note: Measurement Level = Reading Level + Correct Factor



Test Mode :	Mode 9: Full system (HDMI 1 mode 1920*1080@144Hz) Signal from PC for Horizontal (230V/50Hz)		
AC Power :	AC 230V/50Hz	Phase :	NEUTRAL
Equipment :	LCD Monitor	Model No :	*2590*****
Temperature :	25°C	Humidity :	52%
Pressure(mbar) :	1001	Date:	2017/10/23

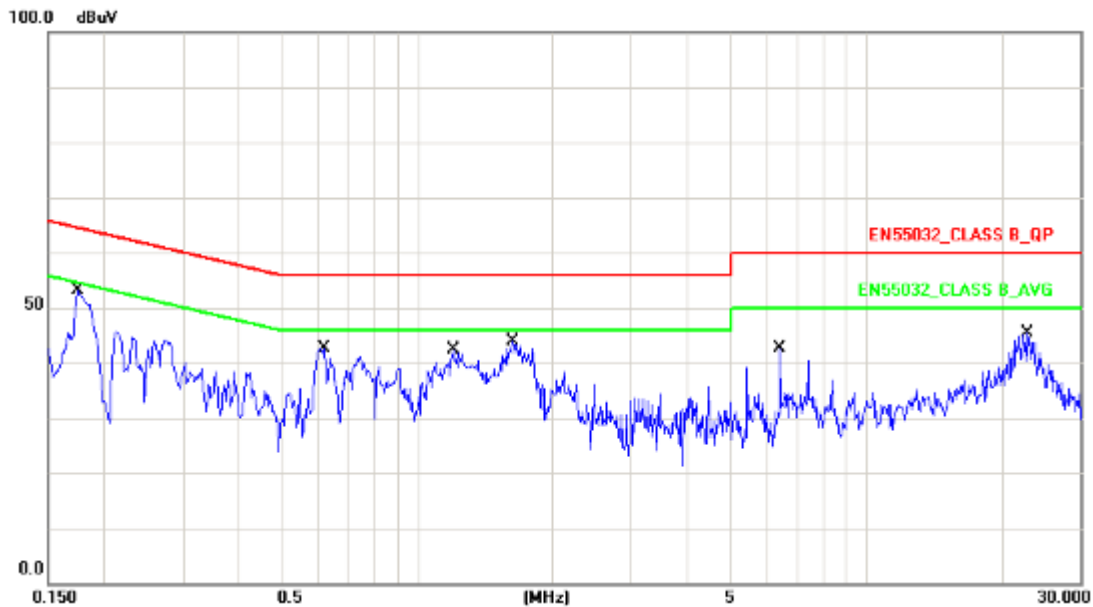

No.	Frequency (MHz)	Factor (dB)	Reading (dBuV)	Level (dBuV)	Limit (dBuV)	Margin (dB)	Detector
1	0.1740	10.13	41.47	51.60	64.76	-13.16	QP
2	0.1740	10.13	26.93	37.06	54.76	-17.70	AVG
3	0.6180	10.16	27.74	37.90	56.00	-18.10	QP
4	0.6180	10.16	11.91	22.07	46.00	-23.93	AVG
5	1.1980	10.18	29.34	39.52	56.00	-16.48	QP
6	1.1980	10.18	22.43	32.61	46.00	-13.39	AVG
7	1.6340	10.18	31.28	41.46	56.00	-14.54	QP
8	1.6340	10.18	25.96	36.14	46.00	-9.86	AVG
9	6.4299	10.27	28.83	39.10	60.00	-20.90	QP
10	6.4299	10.27	27.43	37.70	50.00	-12.30	AVG
11	22.8020	10.39	19.74	30.13	60.00	-29.87	QP
12	22.8020	10.39	13.75	24.14	50.00	-25.86	AVG

Note: Measurement Level = Reading Level + Correct Factor



Test Mode :	Mode 14: Full system (HDMI 2 mode 1920*1080@144Hz) Signal from PC for Horizontal (230V/50Hz)		
AC Power :	AC 230V/50Hz	Phase :	LINE
Equipment :	LCD Monitor	Model No :	*2590*****
Temperature :	25°C	Humidity :	52%
Pressure(mbar) :	1001	Date:	2017/10/23

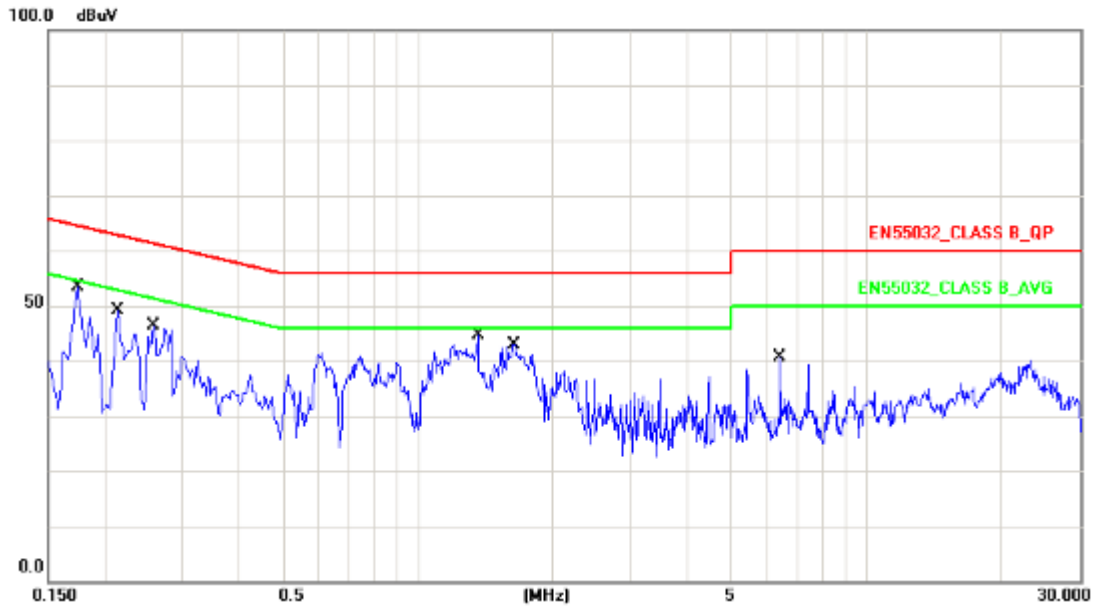

No.	Frequency (MHz)	Factor (dB)	Reading (dBuV)	Level (dBuV)	Limit (dBuV)	Margin (dB)	Detector
1	0.1740	10.13	40.29	50.42	64.76	-14.34	QP
2	0.1740	10.13	27.73	37.86	54.76	-16.90	AVG
3	0.2140	10.12	36.21	46.33	63.04	-16.71	QP
4	0.2140	10.12	25.34	35.46	53.04	-17.58	AVG
5	0.2580	10.13	33.08	43.21	61.49	-18.28	QP
6	0.2580	10.13	24.51	34.64	51.49	-16.85	AVG
7	1.3619	10.16	31.50	41.66	56.00	-14.34	QP
8	1.3619	10.16	27.19	37.35	46.00	-8.65	AVG
9	1.6380	10.17	29.75	39.92	56.00	-16.08	QP
10	1.6380	10.17	24.20	34.37	46.00	-11.63	AVG
11	6.4339	10.25	29.12	39.37	60.00	-20.63	QP
12	6.4339	10.25	26.57	36.82	50.00	-13.18	AVG

Note: Measurement Level = Reading Level + Correct Factor



Test Mode :	Mode 14: Full system (HDMI 2 mode 1920*1080@144Hz) Signal from PC for Horizontal (230V/50Hz)		
AC Power :	AC 230V/50Hz	Phase :	NEUTRAL
Equipment :	LCD Monitor	Model No :	*2590*****
Temperature :	25°C	Humidity :	52%
Pressure(mbar) :	1001	Date:	2017/10/23

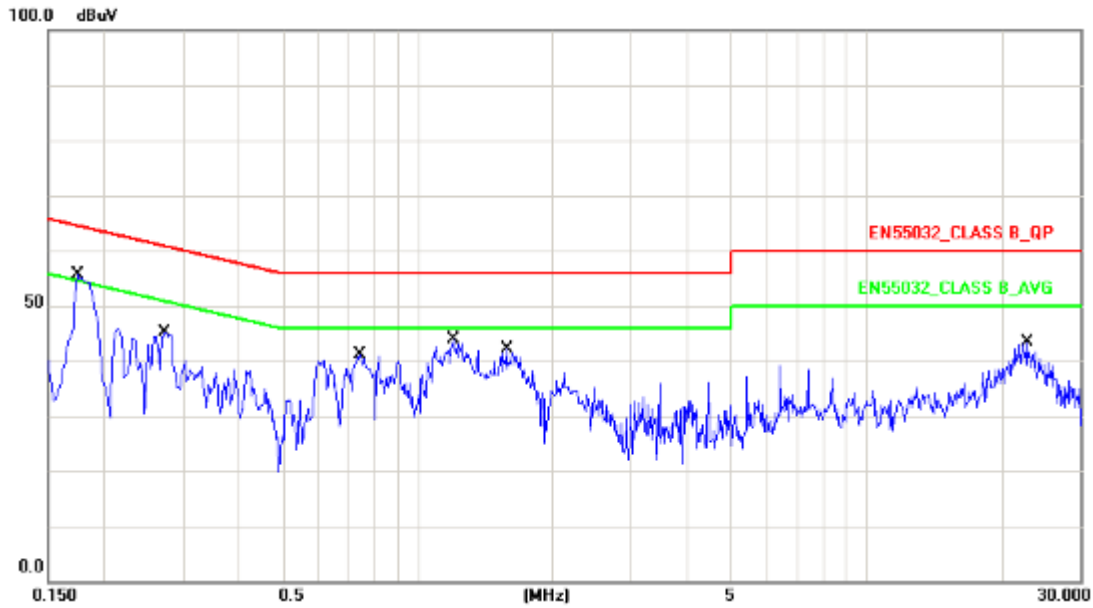

No.	Frequency (MHz)	Factor (dB)	Reading (dBuV)	Level (dBuV)	Limit (dBuV)	Margin (dB)	Detector
1	0.1740	10.13	41.49	51.62	64.76	-13.14	QP
2	0.1740	10.13	26.98	37.11	54.76	-17.65	AVG
3	0.2740	10.13	31.09	41.22	60.99	-19.77	QP
4	0.2740	10.13	21.09	31.22	50.99	-19.77	AVG
5	0.7460	10.15	28.15	38.30	56.00	-17.70	QP
6	0.7460	10.15	18.86	29.01	46.00	-16.99	AVG
7	1.1980	10.18	29.41	39.59	56.00	-16.41	QP
8	1.1980	10.18	22.38	32.56	46.00	-13.44	AVG
9	1.5820	10.18	28.80	38.98	56.00	-17.02	QP
10	1.5820	10.18	22.54	32.72	46.00	-13.28	AVG
11	22.8020	10.39	19.38	29.77	60.00	-30.23	QP
12	22.8020	10.39	13.56	23.95	50.00	-26.05	AVG

Note: Measurement Level = Reading Level + Correct Factor



Test Mode :	Mode 19: Full system (Display mode 1920*1080@144Hz) Signal from PC for Horizontal (110V/60Hz)		
AC Power :	AC 110V/60Hz	Phase :	LINE
Equipment :	LCD Monitor	Model No :	*2590*****
Temperature :	25°C	Humidity :	52%
Pressure(mbar) :	1001	Date:	2017/10/23

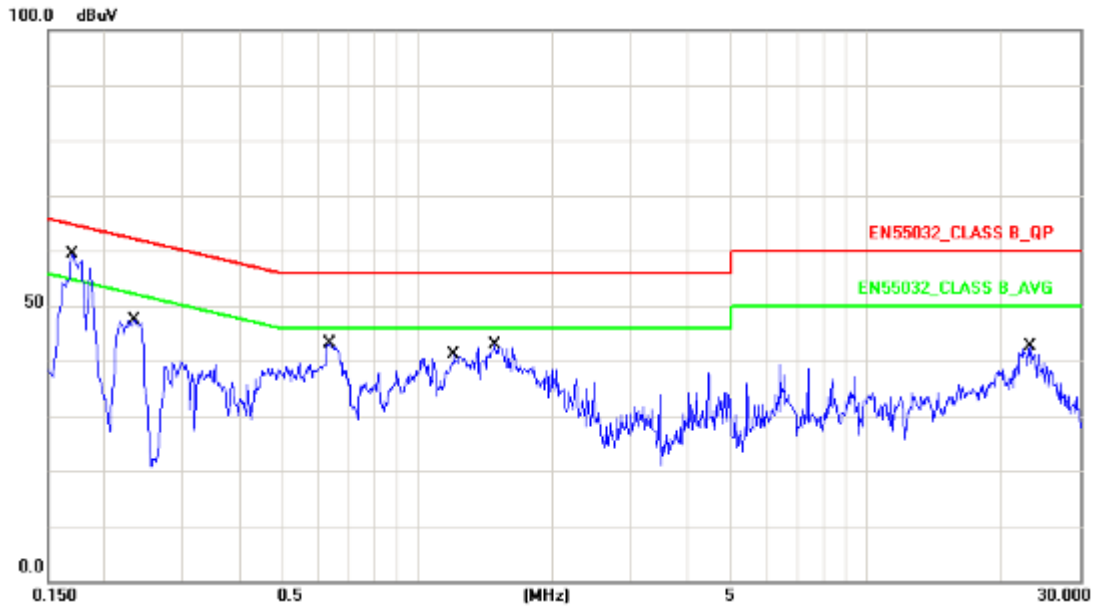

No.	Frequency (MHz)	Factor (dB)	Reading (dBuV)	Level (dBuV)	Limit (dBuV)	Margin (dB)	Detector
1	0.1700	10.13	43.24	53.37	64.96	-11.59	QP
2	0.1700	10.13	30.03	40.16	54.96	-14.80	AVG
3	0.2340	10.12	34.45	44.57	62.30	-17.73	QP
4	0.2340	10.12	20.95	31.07	52.30	-21.23	AVG
5	0.6380	10.15	29.38	39.53	56.00	-16.47	QP
6	0.6380	10.15	17.21	27.36	46.00	-18.64	AVG
7	1.2059	10.16	28.59	38.75	56.00	-17.25	QP
8	1.2059	10.16	20.85	31.01	46.00	-14.99	AVG
9	1.4940	10.16	29.20	39.36	56.00	-16.64	QP
10	1.4940	10.16	22.16	32.32	46.00	-13.68	AVG
11	23.1900	10.40	20.82	31.22	60.00	-28.78	QP
12	23.1900	10.40	14.27	24.67	50.00	-25.33	AVG

Note: Measurement Level = Reading Level + Correct Factor



Test Mode :	Mode 19: Full system (Display mode 1920*1080@144Hz) Signal from PC for Horizontal (110V/60Hz)		
AC Power :	AC 110V/60Hz	Phase :	NEUTRAL
Equipment :	LCD Monitor	Model No :	*2590*****
Temperature :	25°C	Humidity :	52%
Pressure(mbar) :	1001	Date:	2017/10/23

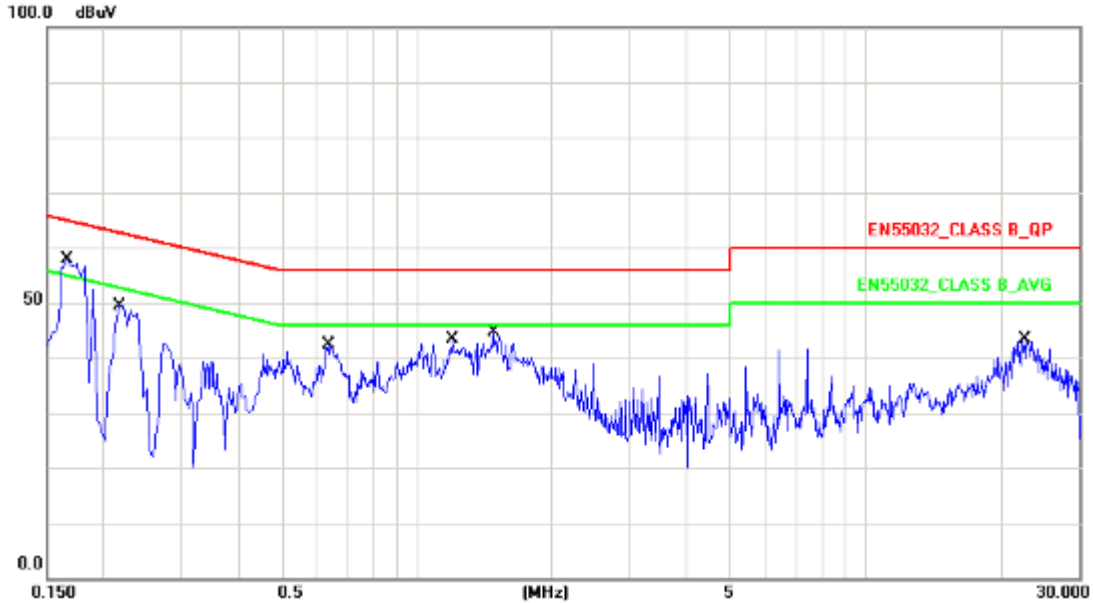

No.	Frequency (MHz)	Factor (dB)	Reading (dBuV)	Level (dBuV)	Limit (dBuV)	Margin (dB)	Detector
1	0.1660	10.13	45.67	55.80	65.15	-9.35	QP
2	0.1660	10.13	29.76	39.89	55.15	-15.26	AVG
3	0.2180	10.13	36.71	46.84	62.89	-16.05	QP
4	0.2180	10.13	18.26	28.39	52.89	-24.50	AVG
5	0.6380	10.16	29.51	39.67	56.00	-16.33	QP
6	0.6380	10.16	17.42	27.58	46.00	-18.42	AVG
7	1.2059	10.18	29.71	39.89	56.00	-16.11	QP
8	1.2059	10.18	21.78	31.96	46.00	-14.04	AVG
9	1.4860	10.18	30.82	41.00	56.00	-15.00	QP
10	1.4860	10.18	24.56	34.74	46.00	-11.26	AVG
11	22.7660	10.39	27.45	37.84	60.00	-22.16	QP
12	22.7660	10.39	23.18	33.57	50.00	-16.43	AVG

Note: Measurement Level = Reading Level + Correct Factor



Test Mode :	Mode 20: Full system (VGA mode 1920*1080@144Hz) Signal from PC for Horizontal (110V/60Hz)		
AC Power :	AC 110V/60Hz	Phase :	LINE
Equipment :	LCD Monitor	Model No :	*2590*****
Temperature :	25°C	Humidity :	52%
Pressure(mbar) :	1001	Date:	2017/10/23

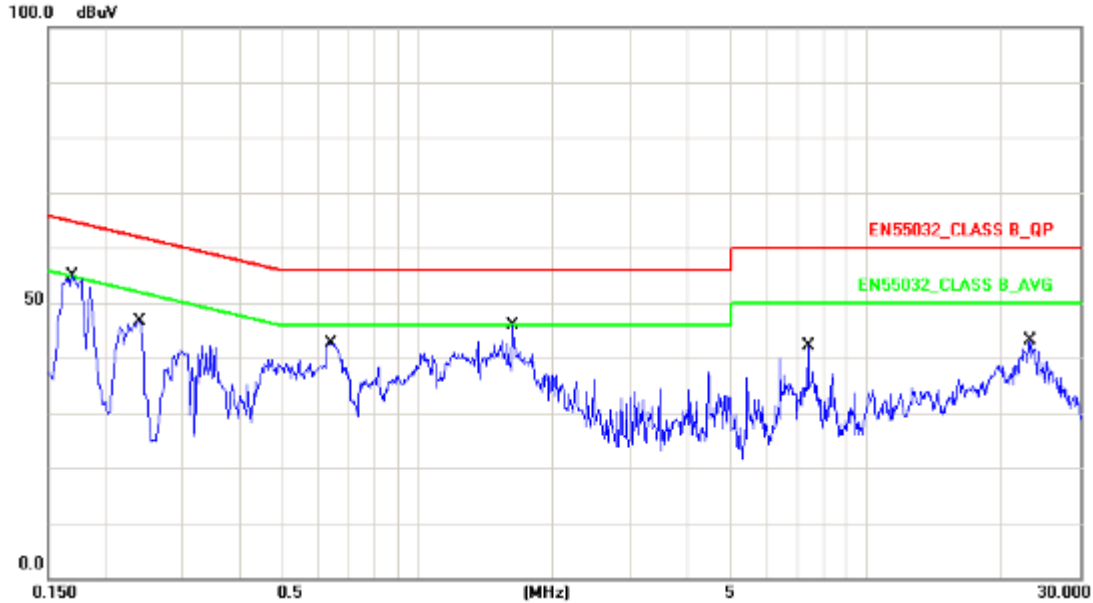

No.	Frequency (MHz)	Factor (dB)	Reading (dBuV)	Level (dBuV)	Limit (dBuV)	Margin (dB)	Detector
1	0.1700	10.13	43.36	53.49	64.96	-11.47	QP
2	0.1700	10.13	29.97	40.10	54.96	-14.86	AVG
3	0.2403	10.12	32.46	42.58	62.08	-19.50	QP
4	0.2403	10.12	16.41	26.53	52.08	-25.55	AVG
5	0.6419	10.15	29.40	39.55	56.00	-16.45	QP
6	0.6419	10.15	17.56	27.71	46.00	-18.29	AVG
7	1.6340	10.17	28.60	38.77	56.00	-17.23	QP
8	1.6340	10.17	24.99	35.16	46.00	-10.84	AVG
9	7.4219	10.26	28.07	38.33	60.00	-21.67	QP
10	7.4219	10.26	25.30	35.56	50.00	-14.44	AVG
11	23.1900	10.40	20.88	31.28	60.00	-28.72	QP
12	23.1900	10.40	14.42	24.82	50.00	-25.18	AVG

Note: Measurement Level = Reading Level + Correct Factor



Test Mode :	Mode 20: Full system (VGA mode 1920*1080@144Hz) Signal from PC for Horizontal (110V/60Hz)		
AC Power :	AC 110V/60Hz	Phase :	NEUTRAL
Equipment :	LCD Monitor	Model No :	*2590*****
Temperature :	25°C	Humidity :	52%
Pressure(mbar) :	1001	Date:	2017/10/23

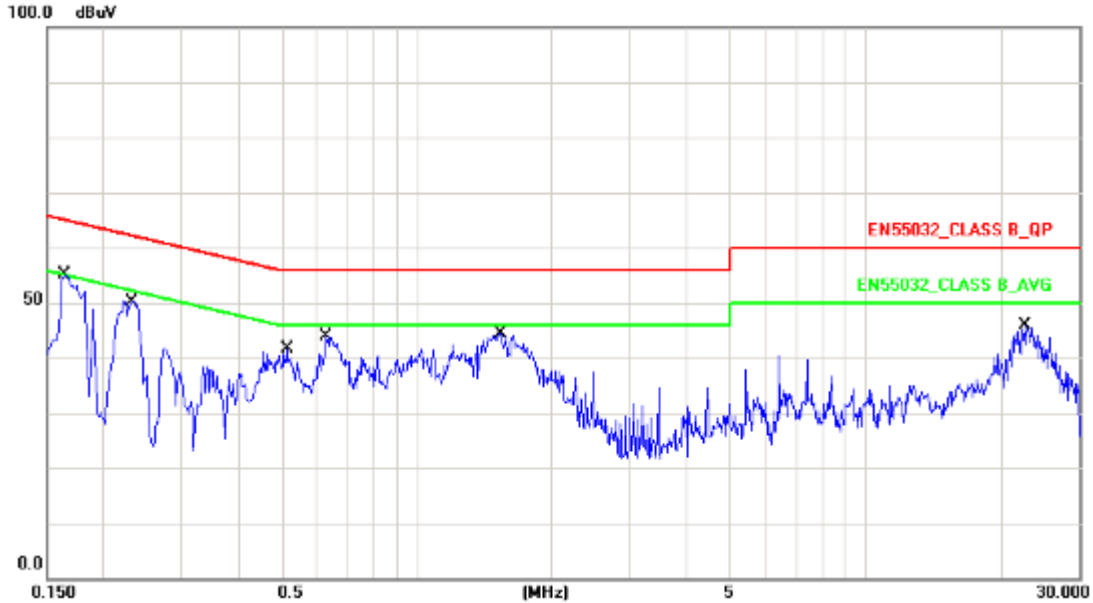

No.	Frequency (MHz)	Factor (dB)	Reading (dBuV)	Level (dBuV)	Limit (dBuV)	Margin (dB)	Detector
1	0.1641	10.13	45.32	55.45	65.25	-9.80	QP
2	0.1641	10.13	28.51	38.64	55.25	-16.61	AVG
3	0.2316	10.13	35.63	45.76	62.39	-16.63	QP
4	0.2316	10.13	20.38	30.51	52.39	-21.88	AVG
5	0.5140	10.15	25.63	35.78	56.00	-20.22	QP
6	0.5140	10.15	18.95	29.10	46.00	-16.90	AVG
7	0.6300	10.16	28.71	38.87	56.00	-17.13	QP
8	0.6300	10.16	14.56	24.72	46.00	-21.28	AVG
9	1.5380	10.18	29.94	40.12	56.00	-15.88	QP
10	1.5380	10.18	22.90	33.08	46.00	-12.92	AVG
11	22.7660	10.39	21.91	32.30	60.00	-27.70	QP
12	22.7660	10.39	16.10	26.49	50.00	-23.51	AVG

Note: Measurement Level = Reading Level + Correct Factor



Test Mode :	Mode 21: Full system (HDMI 1 mode 1920*1080@144Hz) Signal from PC for Horizontal (110V/60Hz)		
AC Power :	AC 110V/60Hz	Phase :	LINE
Equipment :	LCD Monitor	Model No :	*2590*****
Temperature :	25°C	Humidity :	52%
Pressure(mbar) :	1001	Date:	2017/10/23

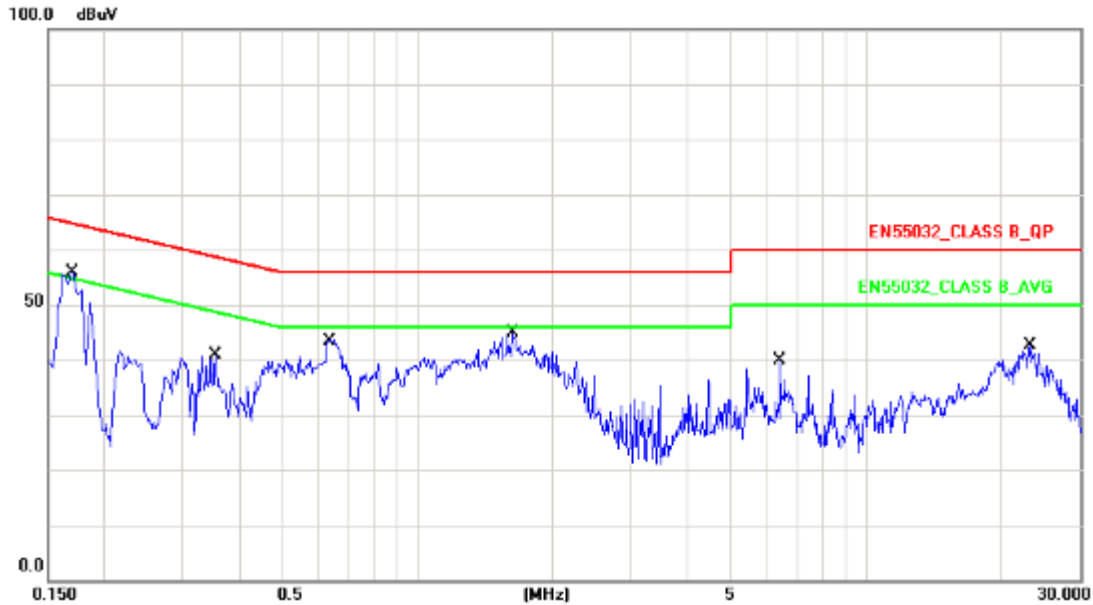

No.	Frequency (MHz)	Factor (dB)	Reading (dBuV)	Level (dBuV)	Limit (dBuV)	Margin (dB)	Detector
1	0.1700	10.13	43.67	53.80	64.96	-11.16	QP
2	0.1700	10.13	30.14	40.27	54.96	-14.69	AVG
3	0.3540	10.15	26.24	36.39	58.87	-22.48	QP
4	0.3540	10.15	13.91	24.06	48.87	-24.81	AVG
5	0.6300	10.15	28.47	38.62	56.00	-17.38	QP
6	0.6300	10.15	14.25	24.40	46.00	-21.60	AVG
7	1.6340	10.17	28.48	38.65	56.00	-17.35	QP
8	1.6340	10.17	24.74	34.91	46.00	-11.09	AVG
9	6.4339	10.25	29.97	40.22	60.00	-19.78	QP
10	6.4339	10.25	27.59	37.84	50.00	-12.16	AVG
11	23.1900	10.40	21.99	32.39	60.00	-27.61	QP
12	23.1900	10.40	16.49	26.89	50.00	-23.11	AVG

Note: Measurement Level = Reading Level + Correct Factor



Test Mode :	Mode 21: Full system (HDMI 1 mode 1920*1080@144Hz) Signal from PC for Horizontal (110V/60Hz)		
AC Power :	AC 110V/60Hz	Phase :	NEUTRAL
Equipment :	LCD Monitor	Model No :	*2590*****
Temperature :	25°C	Humidity :	52%
Pressure(mbar) :	1001	Date:	2017/10/23

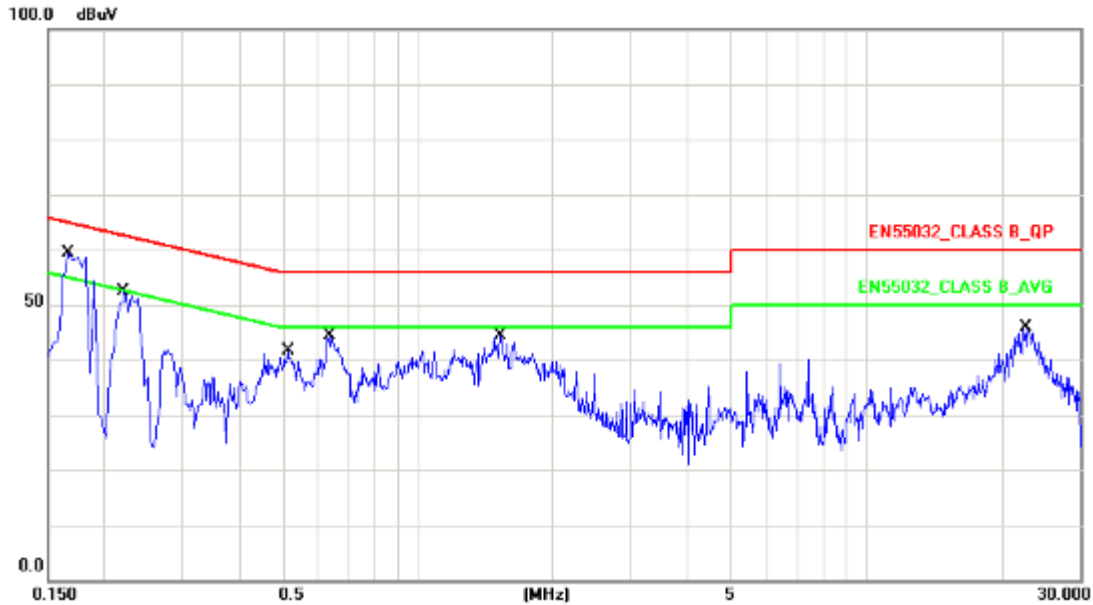

No.	Frequency (MHz)	Factor (dB)	Reading (dBuV)	Level (dBuV)	Limit (dBuV)	Margin (dB)	Detector
1	0.1660	10.13	45.25	55.38	65.15	-9.77	QP
2	0.1660	10.13	29.39	39.52	55.15	-15.63	AVG
3	0.2220	10.13	36.22	46.35	62.74	-16.39	QP
4	0.2220	10.13	19.86	29.99	52.74	-22.75	AVG
5	0.5140	10.15	25.75	35.90	56.00	-20.10	QP
6	0.5140	10.15	18.94	29.09	46.00	-16.91	AVG
7	0.6380	10.16	29.41	39.57	56.00	-16.43	QP
8	0.6380	10.16	17.41	27.57	46.00	-18.43	AVG
9	1.5339	10.18	29.28	39.46	56.00	-16.54	QP
10	1.5339	10.18	22.29	32.47	46.00	-13.53	AVG
11	22.7660	10.39	20.87	31.26	60.00	-28.74	QP
12	22.7660	10.39	14.83	25.22	50.00	-24.78	AVG

Note: Measurement Level = Reading Level + Correct Factor



Test Mode :	Mode 22: Full system (HDMI 2 mode 1920*1080@144Hz) Signal from PC for Horizontal (110V/60Hz)		
AC Power :	AC 110V/60Hz	Phase :	LINE
Equipment :	LCD Monitor	Model No :	*2590*****
Temperature :	25°C	Humidity :	52%
Pressure(mbar) :	1001	Date:	2017/10/23

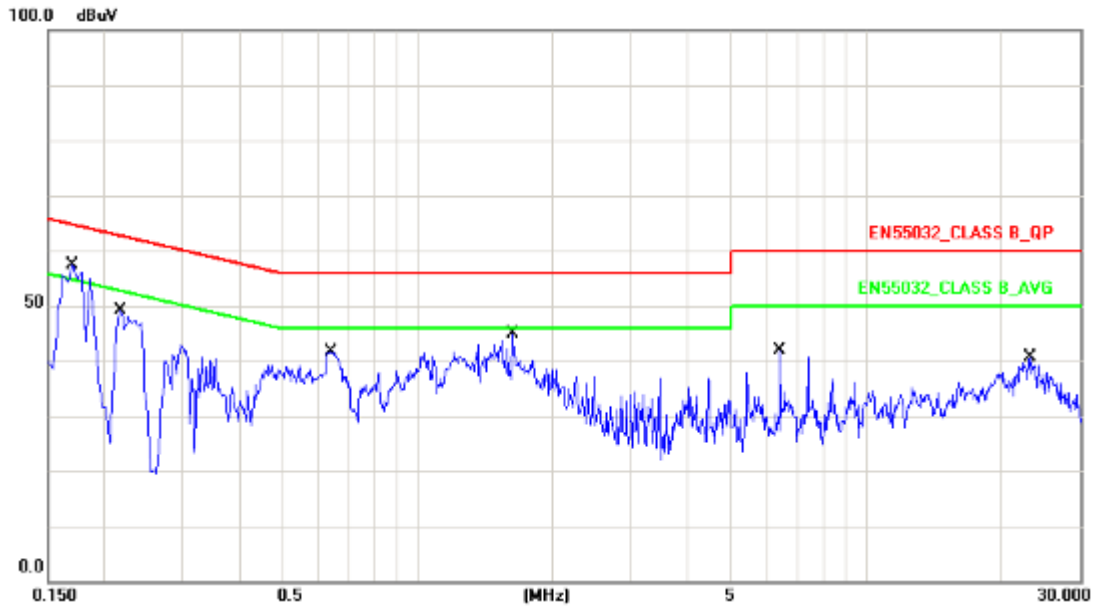

No.	Frequency (MHz)	Factor (dB)	Reading (dBuV)	Level (dBuV)	Limit (dBuV)	Margin (dB)	Detector
1	0.1700	10.13	43.78	53.91	64.96	-11.05	QP
2	0.1700	10.13	30.37	40.50	54.96	-14.46	AVG
3	0.2180	10.12	35.78	45.90	62.89	-16.99	QP
4	0.2180	10.12	19.11	29.23	52.89	-23.66	AVG
5	0.6419	10.15	29.36	39.51	56.00	-16.49	QP
6	0.6419	10.15	17.58	27.73	46.00	-18.27	AVG
7	1.6340	10.17	28.38	38.55	56.00	-17.45	QP
8	1.6340	10.17	24.90	35.07	46.00	-10.93	AVG
9	6.4339	10.25	29.86	40.11	60.00	-19.89	QP
10	6.4339	10.25	27.15	37.40	50.00	-12.60	AVG
11	23.1900	10.40	22.87	33.27	60.00	-26.73	QP
12	23.1900	10.40	17.92	28.32	50.00	-21.68	AVG

Note: Measurement Level = Reading Level + Correct Factor



Test Mode :	Mode 22: Full system (HDMI 2 mode 1920*1080@144Hz) Signal from PC for Horizontal (110V/60Hz)		
AC Power :	AC 110V/60Hz	Phase :	NEUTRAL
Equipment :	LCD Monitor	Model No :	*2590*****
Temperature :	25°C	Humidity :	52%
Pressure(mbar) :	1001	Date:	2017/10/23

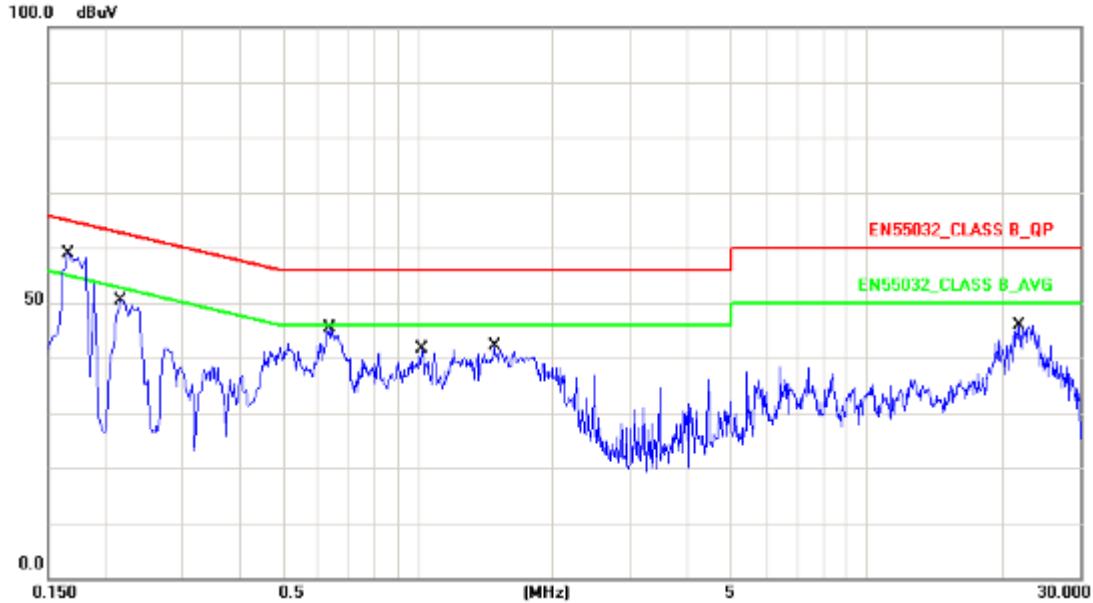

No.	Frequency (MHz)	Factor (dB)	Reading (dBuV)	Level (dBuV)	Limit (dBuV)	Margin (dB)	Detector
1	0.1660	10.13	45.16	55.29	65.15	-9.86	QP
2	0.1660	10.13	29.38	39.51	55.15	-15.64	AVG
3	0.2180	10.13	36.09	46.22	62.89	-16.67	QP
4	0.2180	10.13	18.01	28.14	52.89	-24.75	AVG
5	0.6380	10.16	29.58	39.74	56.00	-16.26	QP
6	0.6380	10.16	17.47	27.63	46.00	-18.37	AVG
7	1.0220	10.18	27.96	38.14	56.00	-17.86	QP
8	1.0220	10.18	20.44	30.62	46.00	-15.38	AVG
9	1.4860	10.18	30.92	41.10	56.00	-14.90	QP
10	1.4860	10.18	24.71	34.89	46.00	-11.11	AVG
11	22.0180	10.40	16.59	26.99	60.00	-33.01	QP
12	22.0180	10.40	11.12	21.52	50.00	-28.48	AVG

Note: Measurement Level = Reading Level + Correct Factor

Test engineer: Sun. Zhang



4.5.2 Conducted Emission for Telecommunication Port Test Data

Note: The EUT doesn't have the telecommunication port.



4.6. Test Photographs

Front View



Rear View





5. Test of Radiated Emission

5.1. Test Limit

The EUT shall meet the limits of below Table when measured at the measuring distance R in accordance with the methods described in European Standard EN 55032. If the reading on the measuring receiver shows fluctuations close to the limit, the reading shall be observed for at least 15 s at each measurement frequency; the highest reading shall be recorded, with the exception of any brief isolated high reading, which shall be ignored.

Table 1 – Required highest frequency for radiated measurement

Highest internal frequency (F_x)	Highest measured frequency
$F_x \leq 108$ MHz	1 GHz
108 MHz < $F_x \leq 500$ MHz	2 GHz
500 MHz < $F_x \leq 1$ GHz	5 GHz
$F_x > 1$ GHz	$5 \times F_x$ up to a maximum of 6 GHz

NOTE 1 For FM and TV broadcast receivers, F_x is determined from the highest frequency generated or used excluding the local oscillator and tuned frequencies.

NOTE 2 F_x is defined in 3.1.19.

Where the F_x is unknown, the radiated emission measurements shall be performed up to 6 GHz.

Table A.2 – Requirements for radiated emissions at frequencies up to 1 GHz for Class A equipment

Table clause	Frequency range MHz	Measurement		Class A limits dB(μ V/m)
		Distance m	Detector type/ bandwidth	OATS/SAC (see Table A.1)
A2.1	30 – 230	10	Quasi Peak / 120 kHz	40
	230 – 1 000			47
A2.2	30 – 230	3		50
	230 – 1 000			57

NOTE Apply only A2.1 or A2.2 across the entire frequency range.

Table A.3 – Requirements for radiated emissions at frequencies above 1 GHz for Class A equipment

Table clause	Frequency range MHz	Measurement		Class A limits dB(μ V/m)
		Distance m	Detector type/ bandwidth	FSOATS (see Table A.1)
A3.1	1 000 – 3 000	3	Average / 1 MHz	56
	3 000 – 6 000			60
A3.2	1 000 – 3 000		Peak / 1 MHz	76
	3 000 – 6 000			80

NOTE Apply A3.1 and A3.2 across the frequency range from 1 000 MHz to the highest required frequency of measurement derived from Table 1.

**Table A.4 – Requirements for radiated emissions at frequencies up to 1 GHz for Class B equipment**

Table clause	Frequency range MHz	Measurement		Class B limits dB(μ V/m)
		Distance m	Detector type/ bandwidth	OATS/SAC (see Table A.1)
A4.1	30 – 230	10	Quasi Peak / 120 kHz	30
	230 – 1 000			37
A4.2	30 – 230	3		40
	230 – 1 000			47

NOTE Apply only table clause A4.1 or A4.2 across the entire frequency range.

Table A.5 – Requirements for radiated emissions at frequencies above 1 GHz for Class B equipment

Table clause	Frequency range MHz	Measurement		Class B limits dB(μ V/m)
		Distance m	Detector type/ bandwidth	FSOATS (see Table A.1)
A5.1	1 000 – 3 000	3	Average/ 1 MHz	50
	3 000 – 6 000			54
A5.2	1 000 – 3 000		Peak/ 1 MHz	70
	3 000 – 6 000			74

NOTE Apply A5.1 and A5.2 across the frequency range from 1 000 MHz to the highest required frequency of measurement derived from Table 1.

Table A.6 – Requirements for radiated emissions from FM receivers

Table clause	Frequency range MHz	Measurement		Class B limit dB(μ V/m)	
		Distance m	Detector type/ bandwidth	Fundamental	Harmonics
				OATS/SAC (see Table A.1)	OATS/SAC (see Table A.1)
A6.1	30 – 230	10	Quasi peak/ 120 kHz	50	42
	230 – 300				42
	300 – 1 000				46
A6.2	30 – 230	3		60	52
	230 – 300				52
	300 – 1 000				56

NOTE 1 Apply only A.6.1 or A.6.2 across the entire frequency range.

NOTE 2 These relaxed limits apply only to emissions at the fundamental and harmonic frequencies of the local oscillator. Signals at all other frequencies shall be compliant with the limits given in Table A.4.



Table A.12 – Requirements for conducted differential voltage emissions from Class B equipment

Applicable to						
1. TV broadcast receiver tuner ports (3.1.8) with an accessible connector						
2. RF modulator output ports (3.1.27)						
3. FM broadcast receiver tuner ports (3.1.8) with an accessible connector						
Table clause	Frequency range MHz	Detector type/ bandwidth	Class B limits dB(μV) 75 Ω			Applicability
			Other	Local Oscillator Fundamental	Local Oscillator Harmonics	
A12.1	30 – 950	For frequencies ≤1 GHz	46	46	46	See NOTE 1
	950 – 2 150		46	54	54	
A12.2	950 – 2 150	Quasi Peak/ 120 kHz	46	54	54	See NOTE 2
A12.3	30 – 300		For frequencies ≥1 GHz	46	54	50
	300 – 1 000	52				
A12.4	30 – 300	Peak/ 1 MHz	46	66	59	See NOTE 4
	300 – 1 000				52	
A12.5	30 – 950	Peak/ 1 MHz	46	76	46	See NOTE 5
	950 – 2 150			n/a	54	

NOTE 1 Television receivers (analogue or digital), video recorders and PC TV broadcast receiver tuner cards working in channels between 30 MHz and 1 GHz, and digital audio receivers.

NOTE 2 Tuner units (not the LNB) for satellite signal reception.

NOTE 3 Frequency modulation audio receivers and PC tuner cards.

NOTE 4 Frequency modulation car radios.

NOTE 5 Applicable to EUTs with RF modulator output ports (for example DVD equipment, video recorders, camcorders and decoders etc.) designed to connect to TV broadcast receiver tuner ports.

NOTE 6 Testing is required at only one EUT supply voltage and frequency.

NOTE 7 The term 'other' refers to all emissions other than the fundamental and the harmonics of the local oscillator.

NOTE 8 The test shall be performed with the device operating at each reception channel.

NOTE 9 The test shall cover the entire frequency range.

5.2. Test Procedures

- a. The EUT was placed on a rotatable table top 0.8 meter above ground.
- b. The EUT was set 3/10 meters from the interference receiving antenna which was mounted on the top of a variable height antenna tower.
- c. The table was rotated 360 degrees to determine the position of the highest radiation.
- d. The antenna is a half wave dipole and its height is varied between one meter and four meters above ground to find the maximum value of the field strength both horizontal polarization and vertical polarization of the antenna are set to make the measurement. For each suspected emission the EUT was arranged to its worst case and then tune the antenna tower (from 1 M to 4 M) and turn table (from 0 degree to 360 degrees) to find the maximum reading.
- e. Set the test-receiver system to Peak Detect Function and specified bandwidth with Maximum Hold Mode.
- f. If the emission level of the EUT in peak mode was 3 dB lower than the limit specified, then testing will be stopped and peak values of EUT will be reported, otherwise, the emissions which do not have 3 dB margin will be repeated one by one using the quasi-peak method and reported.

5.3. Typical Test Setup

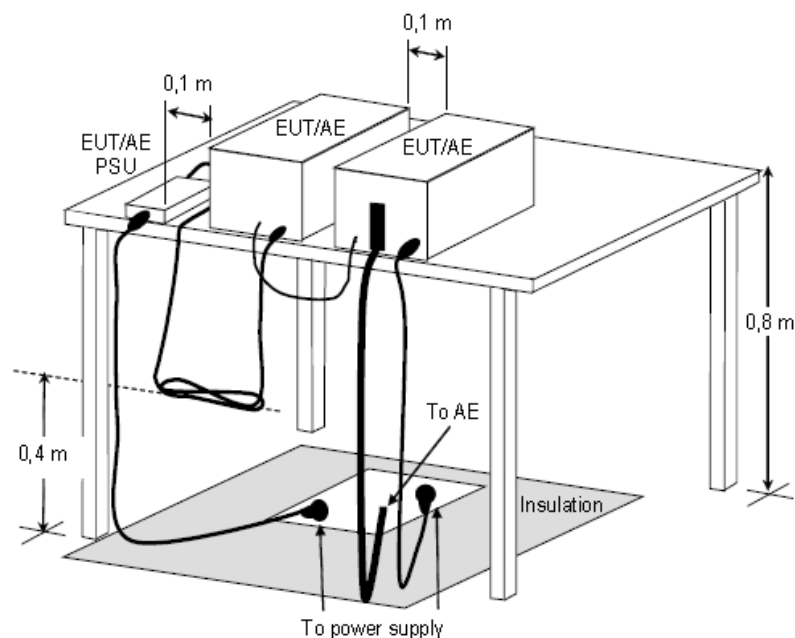

Figure D.8 – Example measurement arrangement for table-top EUT
(Radiated emission measurement)



5.4. Measurement Equipment

Instrument/Ancillary	Manufacturer	Model No.	Serial No.	Calibration Date	Valid Date.
EMI Test Receiver	R&S	ESC17	100968	2017.08.06	2018.08.05
Preamplifier	Agilent	87405B	My39500554	2017.03.22	2018.03.21
Preamplifier	Agilent	8449B	3008A02342	2017.03.22	2018.03.21
Bilog Antenna	Sunol Science	JB1	A072414-2	2017.07.20	2018.07.19
Broad-Band Horn Antenna	Schwarzbeck	BBHA9120D	9120D-618	2017.04.22	2018.04.22
Spectrum Analyzer	R&S	FSP40	100324	2017.08.06	2018.08.05
Temperature/ Humidity Meter	Zhicheng	ZC1-11	CEP-TH-001	2017.03.28	2018.03.27
EZ-EMC	Fala	Ver CT3A1	N/A	N/A	N/A



5.5. Test Result and Data (30MHz ~ 1000MHz)

Test Mode :	Mode 1: Full system (Display mode 1920*1080@144Hz) Signal from PC for Horizontal (230V/50Hz)		
AC Power :	AC 230V/50Hz	Ant. Polarization:	Horizontal
Equipment :	LCD Monitor	Model No :	*2590*****
Temperature :	25°C	Humidity :	52%
Pressure(mbar) :	1001	Date:	2017/10/22

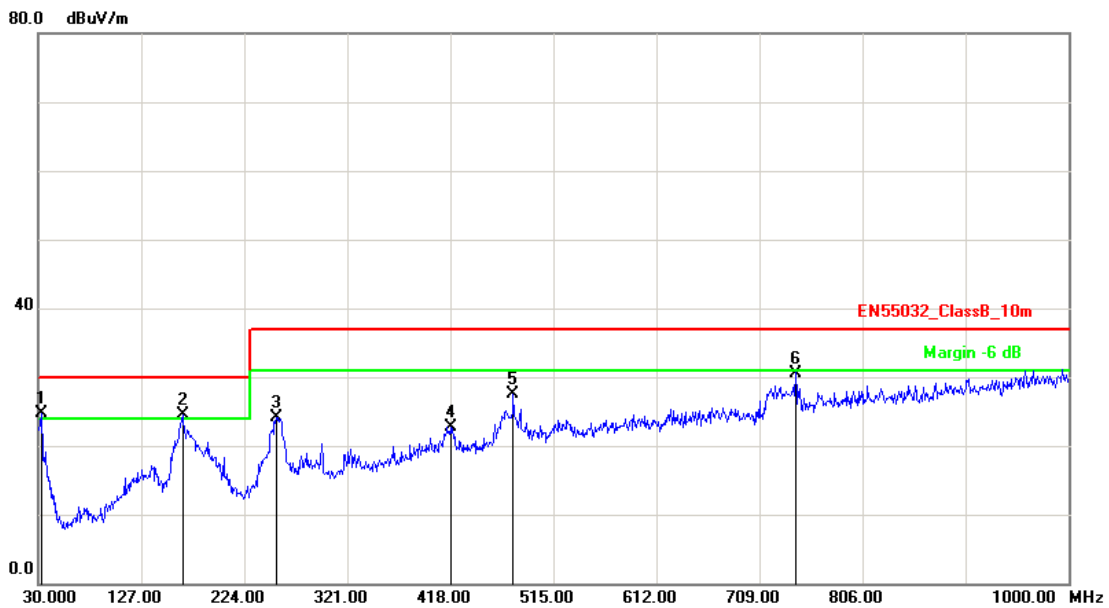

No.	Frequency (MHz)	Factor (dB/m)	Reading (dBuV)	Level (dBuV/m)	Limit (dBuV/m)	Margin (dB)	Det.	Height (cm)	Azimuth (deg)
1	32.9099	-5.36	30.13	24.77	30.00	-5.23	peak	400	157
2	165.8000	-11.04	35.55	24.51	30.00	-5.49	peak	400	193
3	255.0399	-10.24	34.34	24.10	37.00	-12.90	peak	400	315
4	418.0000	-5.26	27.89	22.63	37.00	-14.37	peak	100	322
5	477.1700	-3.76	31.32	27.56	37.00	-9.44	peak	100	342
6	742.9500	0.92	29.68	30.60	37.00	-6.40	peak	100	309

Note: Measurement Level = Reading Level + Correct Factor



Test Mode :	Mode 1: Full system (Display mode 1920*1080@144Hz) Signal from PC for Horizontal (230V/50Hz)		
AC Power :	AC 230V/50Hz	Ant. Polarization:	Vertical
Equipment :	LCD Monitor	Model No :	*2590*****
Temperature :	25°C	Humidity :	52%
Pressure(mbar) :	1001	Date:	2017/10/22

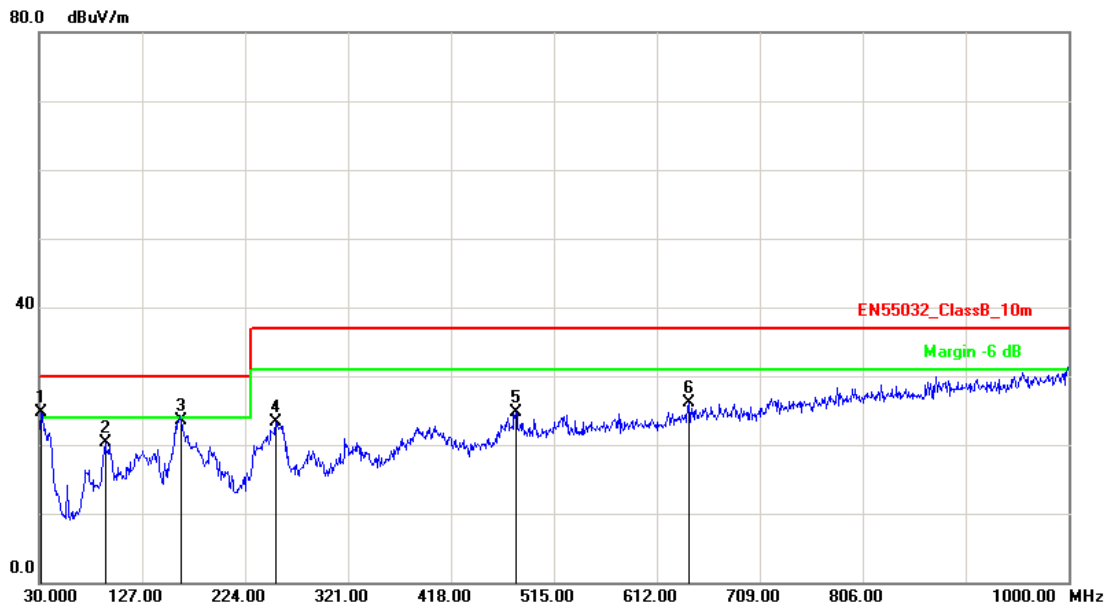

No.	Frequency (MHz)	Factor (dB/m)	Reading (dBuV)	Level (dBuV/m)	Limit (dBuV/m)	Margin (dB)	Det.	Height (cm)	Azimuth (deg)
1	31.9400	-4.66	29.39	24.73	30.00	-5.27	peak	100	162
2	92.0800	-15.79	36.08	20.29	30.00	-9.71	peak	100	101
3	163.8600	-10.98	34.56	23.58	30.00	-6.42	peak	100	116
4	253.1000	-10.32	33.55	23.23	37.00	-13.77	peak	100	204
5	479.1100	-3.69	28.40	24.71	37.00	-12.29	peak	400	357
6	642.0700	-0.49	26.57	26.08	37.00	-10.92	peak	100	11

Note: Measurement Level = Reading Level + Correct Factor



Test Mode :	Mode 5: Full system (VGA mode 1920*1080@144Hz) Signal from PC for Horizontal (230V/50Hz)		
AC Power :	AC 230V/50Hz	Ant. Polarization:	Horizontal
Equipment :	LCD Monitor	Model No :	*2590*****
Temperature :	25°C	Humidity :	52%
Pressure(mbar) :	1001	Date:	2017/10/22

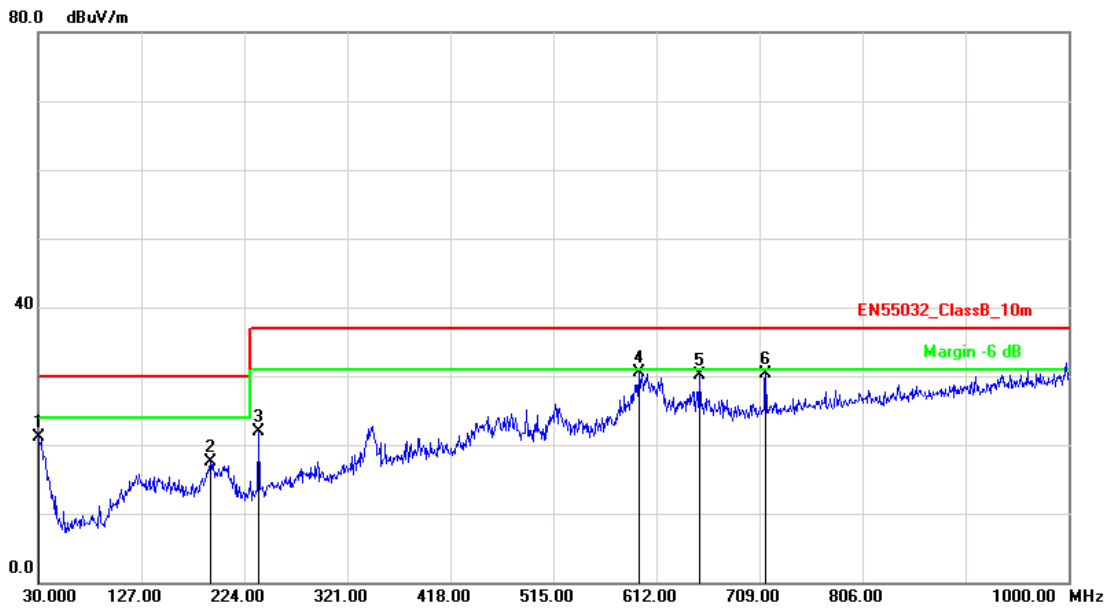

No.	Frequency (MHz)	Factor (dB/m)	Reading (dBuV)	Level (dBuV/m)	Limit (dBuV/m)	Margin (dB)	Det.	Height (cm)	Azimuth (deg)
1	30.0000	-3.26	24.31	21.05	30.00	-8.95	peak	100	9
2	191.9900	-10.54	28.08	17.54	30.00	-12.46	peak	400	157
3	237.5800	-10.98	32.81	21.83	37.00	-15.17	peak	100	153
4	595.5099	-1.31	31.88	30.57	37.00	-6.43	peak	100	146
5	652.7400	-0.26	30.43	30.17	37.00	-6.83	peak	100	135
6	714.8200	0.20	30.05	30.25	37.00	-6.75	peak	400	210

Note: Measurement Level = Reading Level + Correct Factor



Test Mode :	Mode 5: Full system (VGA mode 1920*1080@144Hz) Signal from PC for Horizontal (230V/50Hz)		
AC Power :	AC 230V/50Hz	Ant. Polarization:	Vertical
Equipment :	LCD Monitor	Model No :	*2590*****
Temperature :	25°C	Humidity :	52%
Pressure(mbar) :	1001	Date:	2017/10/22

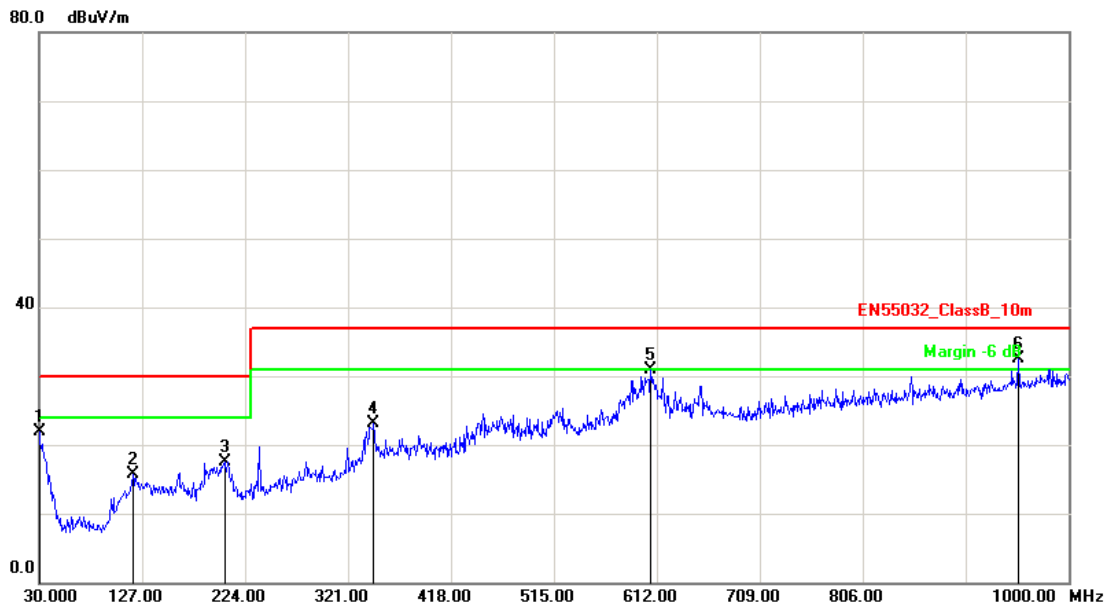

No.	Frequency (MHz)	Factor (dB/m)	Reading (dBuV)	Level (dBuV/m)	Limit (dBuV/m)	Margin (dB)	Det.	Height (cm)	Azimuth (deg)
1	30.0000	-3.26	25.14	21.88	30.00	-8.12	peak	400	0
2	118.2700	-9.92	25.62	15.70	30.00	-14.30	peak	100	183
3	204.6000	-10.38	27.94	17.56	30.00	-12.44	peak	100	172
4	345.2500	-7.55	30.61	23.06	37.00	-13.94	peak	400	121
5	606.1800	-1.16	32.03	30.87	37.00	-6.13	peak	100	158
6	952.4700	4.19	28.35	32.54	37.00	-4.46	peak	100	21

Note: Measurement Level = Reading Level + Correct Factor



Test Mode :	Mode 9: Full system (HDMI 1 mode 1920*1080@144Hz) Signal from PC for Horizontal (230V/50Hz)		
AC Power :	AC 230V/50Hz	Ant. Polarization:	Horizontal
Equipment :	LCD Monitor	Model No :	*2590*****
Temperature :	25°C	Humidity :	52%
Pressure(mbar) :	1001	Date:	2017/10/22

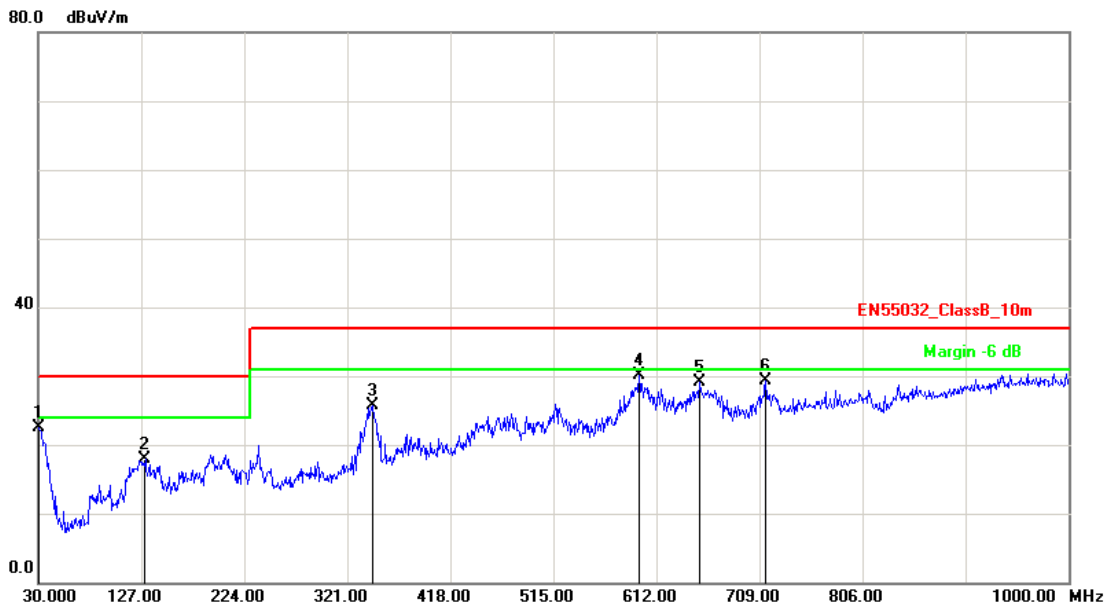

No.	Frequency (MHz)	Factor (dB/m)	Reading (dBuV)	Level (dBuV/m)	Limit (dBuV/m)	Margin (dB)	Det.	Height (cm)	Azimuth (deg)
1	30.0000	-3.26	25.81	22.55	30.00	-7.45	peak	100	265
2	130.8798	-10.02	27.99	17.97	30.00	-12.03	peak	400	141
3	345.2500	-7.55	33.30	25.75	37.00	-11.25	peak	100	258
4	595.5099	-1.31	31.38	30.07	37.00	-6.93	peak	100	235
5	652.7400	-0.26	29.43	29.17	37.00	-7.83	peak	100	301
6	714.8200	0.20	29.05	29.25	37.00	-7.75	peak	400	0

Note: Measurement Level = Reading Level + Correct Factor



Test Mode :	Mode 9: Full system (HDMI 1 mode 1920*1080@144Hz) Signal from PC for Horizontal (230V/50Hz)		
AC Power :	AC 230V/50Hz	Ant. Polarization:	Vertical
Equipment :	LCD Monitor	Model No :	*2590*****
Temperature :	25°C	Humidity :	52%
Pressure(mbar) :	1001	Date:	2017/10/22

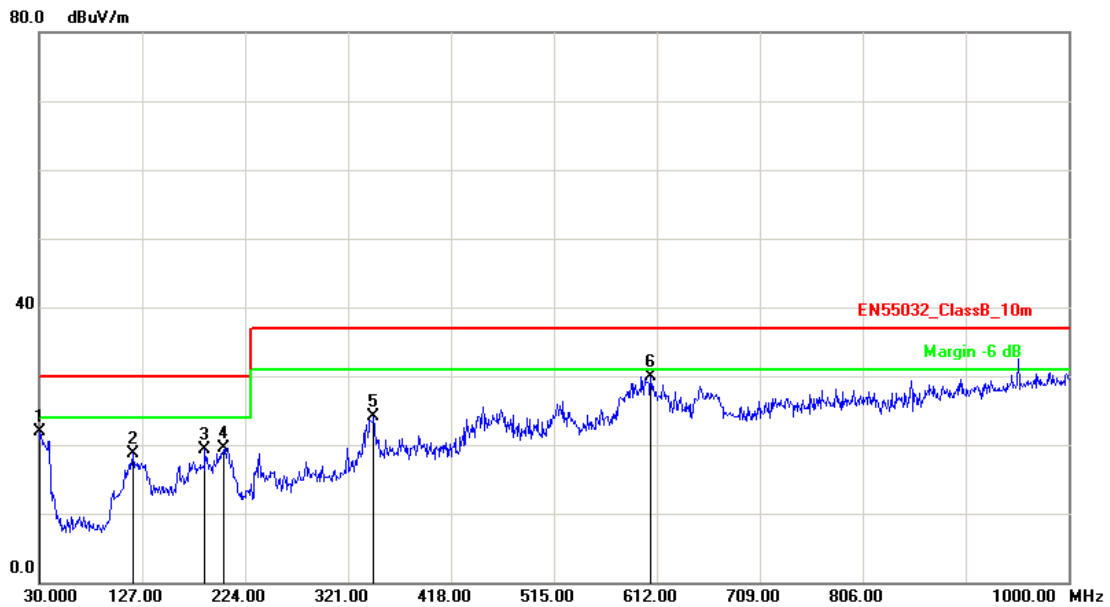

No.	Frequency (MHz)	Factor (dB/m)	Reading (dBuV)	Level (dBuV/m)	Limit (dBuV/m)	Margin (dB)	Det.	Height (cm)	Azimuth (deg)
1	30.0000	-3.26	25.14	21.88	30.00	-8.12	peak	400	128
2	118.2699	-9.92	28.62	18.70	30.00	-11.30	peak	100	42
3	186.1699	-11.00	30.29	19.29	30.00	-10.71	peak	400	305
4	204.5999	-10.38	29.94	19.56	30.00	-10.44	peak	100	126
5	345.2500	-7.55	31.61	24.06	37.00	-12.94	peak	100	10
6	606.1798	-1.16	31.03	29.87	37.00	-7.13	peak	400	3

Note: Measurement Level = Reading Level + Correct Factor



Test Mode :	Mode 14: Full system (HDMI 2 mode 1920*1080@144Hz) Signal from PC for Horizontal (230V/50Hz)		
AC Power :	AC 230V/50Hz	Ant. Polarization:	Horizontal
Equipment :	LCD Monitor	Model No :	*2590*****
Temperature :	25°C	Humidity :	52%
Pressure(mbar) :	1001	Date:	2017/10/22

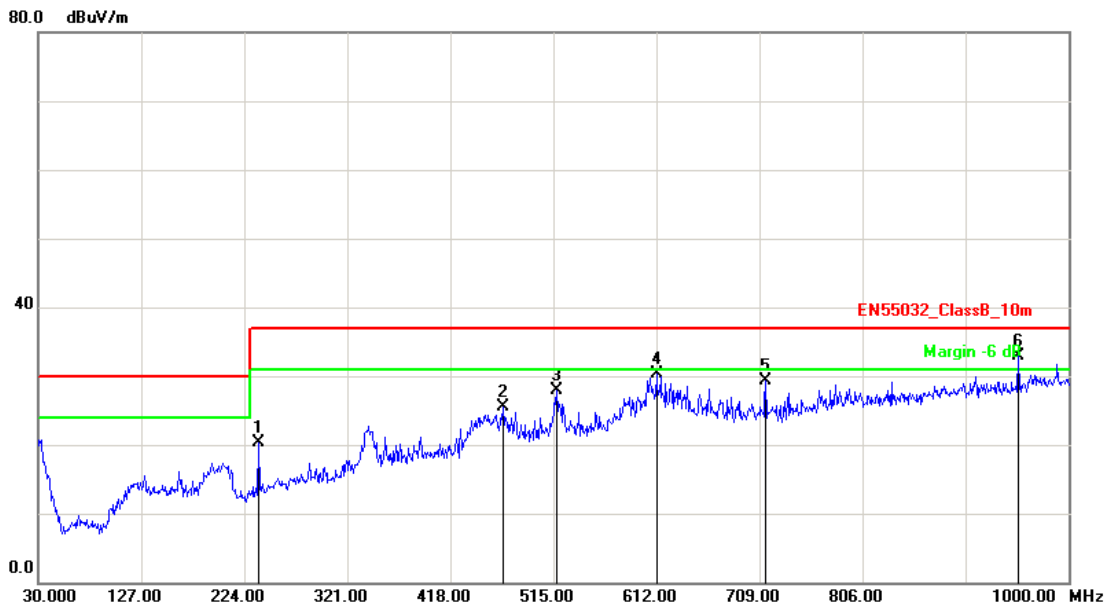

No.	Frequency (MHz)	Factor (dB/m)	Reading (dBuV)	Level (dBuV/m)	Limit (dBuV/m)	Margin (dB)	Det.	Height (cm)	Azimuth (deg)
1	237.5800	-10.98	31.35	20.37	37.00	-16.63	peak	100	166
2	467.4700	-4.08	29.66	25.58	37.00	-11.42	peak	400	159
3	517.9099	-2.66	30.58	27.92	37.00	-9.08	peak	100	133
4	612.0000	-1.08	31.41	30.33	37.00	-6.67	peak	400	215
5	714.8200	0.20	29.10	29.30	37.00	-7.70	peak	100	197
6	952.4700	4.19	28.64	32.83	37.00	-4.17	peak	100	111

Note: Measurement Level = Reading Level + Correct Factor



Test Mode :	Mode 14: Full system (HDMI 2 mode 1920*1080@144Hz) Signal from PC for Horizontal (230V/50Hz)		
AC Power :	AC 230V/50Hz	Ant. Polarization:	Vertical
Equipment :	LCD Monitor	Model No :	*2590*****
Temperature :	25°C	Humidity :	52%
Pressure(mbar) :	1001	Date:	2017/10/22

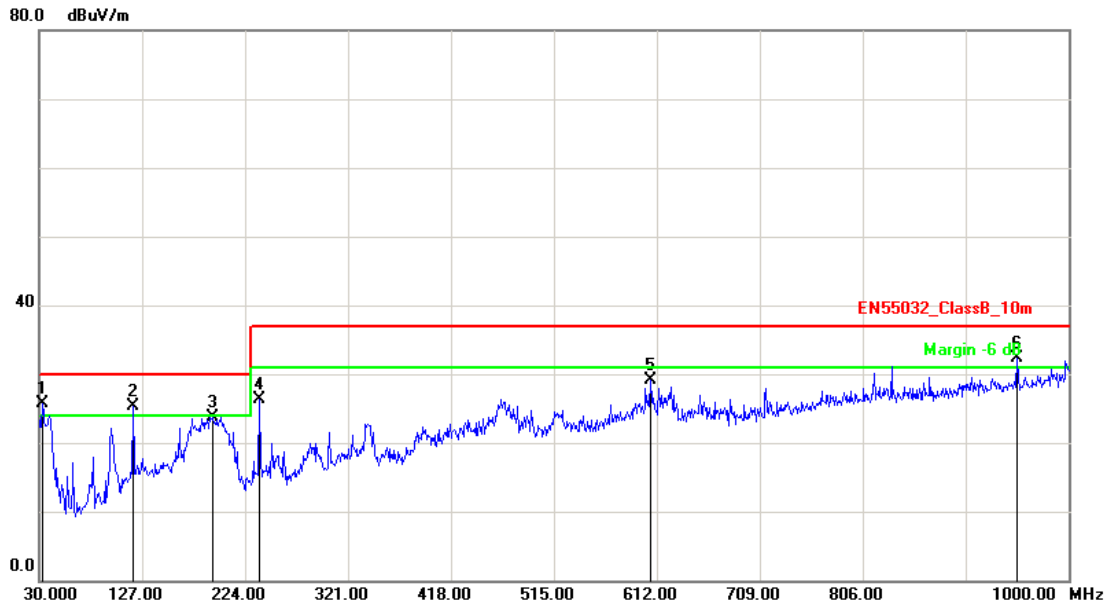

No.	Frequency (MHz)	Factor (dB/m)	Reading (dBuV)	Level (dBuV/m)	Limit (dBuV/m)	Margin (dB)	Det.	Height (cm)	Azimuth (deg)
1	32.9100	-5.36	31.05	25.69	30.00	-4.31	peak	100	220
2	118.2700	-9.92	35.28	25.36	30.00	-4.64	peak	400	141
3	192.9600	-10.47	34.26	23.79	30.00	-6.21	peak	100	335
4	237.5800	-10.98	37.38	26.40	37.00	-10.60	peak	100	324
5	606.1800	-1.16	30.21	29.05	37.00	-7.95	peak	100	181
6	951.5000	4.17	28.16	32.33	37.00	-4.67	peak	400	307

Note: Measurement Level = Reading Level + Correct Factor



Test Mode :	Mode 19: Full system (Display mode 1920*1080@144Hz) Signal from PC for Horizontal (110V/60Hz)		
AC Power :	AC 110V/60Hz	Ant. Polarization:	Horizontal
Equipment :	LCD Monitor	Model No :	*2590*****
Temperature :	25°C	Humidity :	52%
Pressure(mbar) :	1001	Date:	2017/10/22

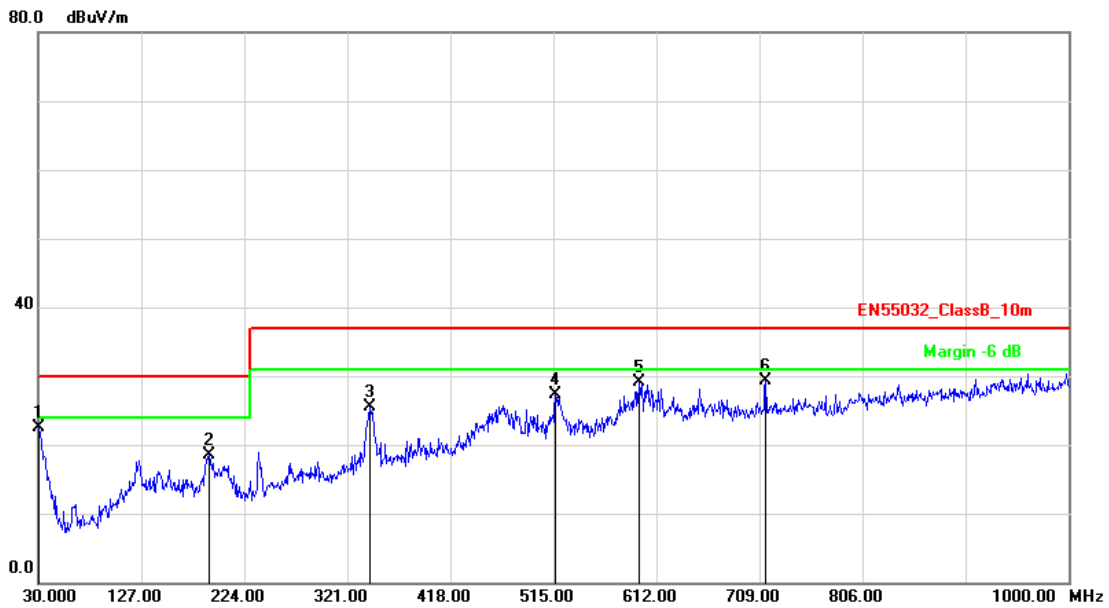

No.	Frequency (MHz)	Factor (dB/m)	Reading (dBuV)	Level (dBuV/m)	Limit (dBuV/m)	Margin (dB)	Det.	Height (cm)	Azimuth (deg)
1	30.0000	-3.26	25.81	22.55	30.00	-7.45	peak	100	174
2	191.0200	-10.62	29.12	18.50	30.00	-11.50	peak	400	85
3	342.3399	-7.69	33.24	25.55	37.00	-11.45	peak	100	25
4	516.9400	-2.68	30.00	27.32	37.00	-9.68	peak	100	168
5	595.5099	-1.31	30.38	29.07	37.00	-7.93	peak	400	302
6	714.8200	0.20	29.05	29.25	37.00	-7.75	peak	100	10

Note: Measurement Level = Reading Level + Correct Factor



Test Mode :	Mode 19: Full system (Display mode 1920*1080@144Hz) Signal from PC for Horizontal (110V/60Hz)		
AC Power :	AC 110V/60Hz	Ant. Polarization:	Vertical
Equipment :	LCD Monitor	Model No :	*2590*****
Temperature :	25°C	Humidity :	52%
Pressure(mbar) :	1001	Date:	2017/10/22

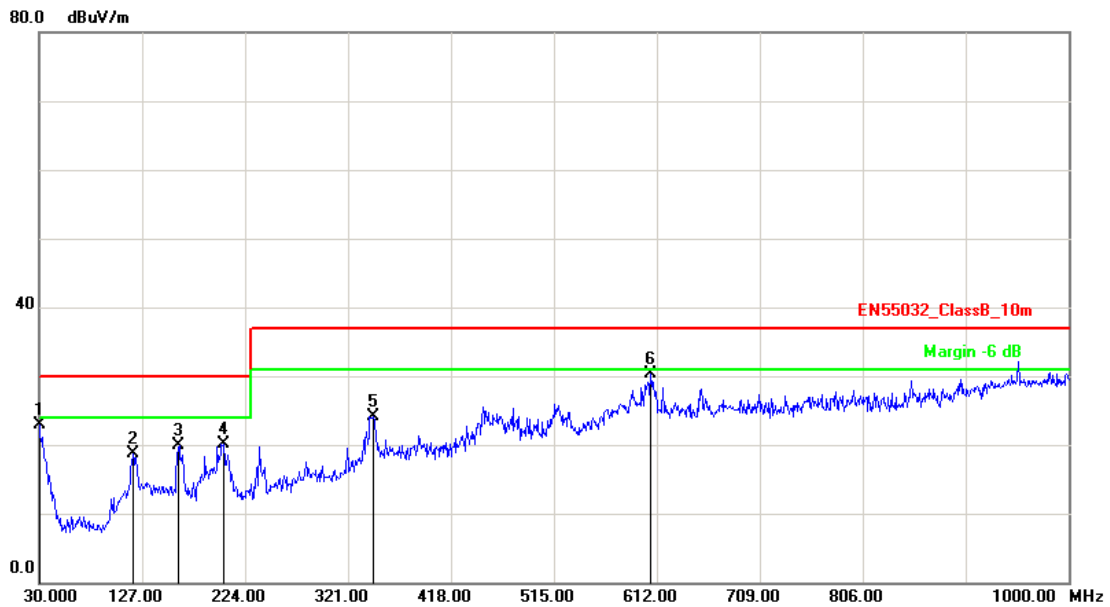

No.	Frequency (MHz)	Factor (dB/m)	Reading (dBuV)	Level (dBuV/m)	Limit (dBuV/m)	Margin (dB)	Det.	Height (cm)	Azimuth (deg)
1	30.0000	-3.26	26.14	22.88	30.00	-7.12	peak	400	171
2	118.2699	-9.92	28.62	18.70	30.00	-11.30	peak	100	81
3	161.9199	-10.92	30.90	19.98	30.00	-10.02	peak	100	268
4	203.6299	-10.28	30.36	20.08	30.00	-9.92	peak	400	301
5	345.2500	-7.55	31.61	24.06	37.00	-12.94	peak	100	5
6	606.1798	-1.16	31.53	30.37	37.00	-6.63	peak	400	0

Note: Measurement Level = Reading Level + Correct Factor



Test Mode :	Mode 20: Full system (VGA mode 1920*1080@144Hz) Signal from PC for Horizontal (110V/60Hz)		
AC Power :	AC 110V/60Hz	Ant. Polarization:	Horizontal
Equipment :	LCD Monitor	Model No :	*2590*****
Temperature :	25°C	Humidity :	52%
Pressure(mbar) :	1001	Date:	2017/10/22

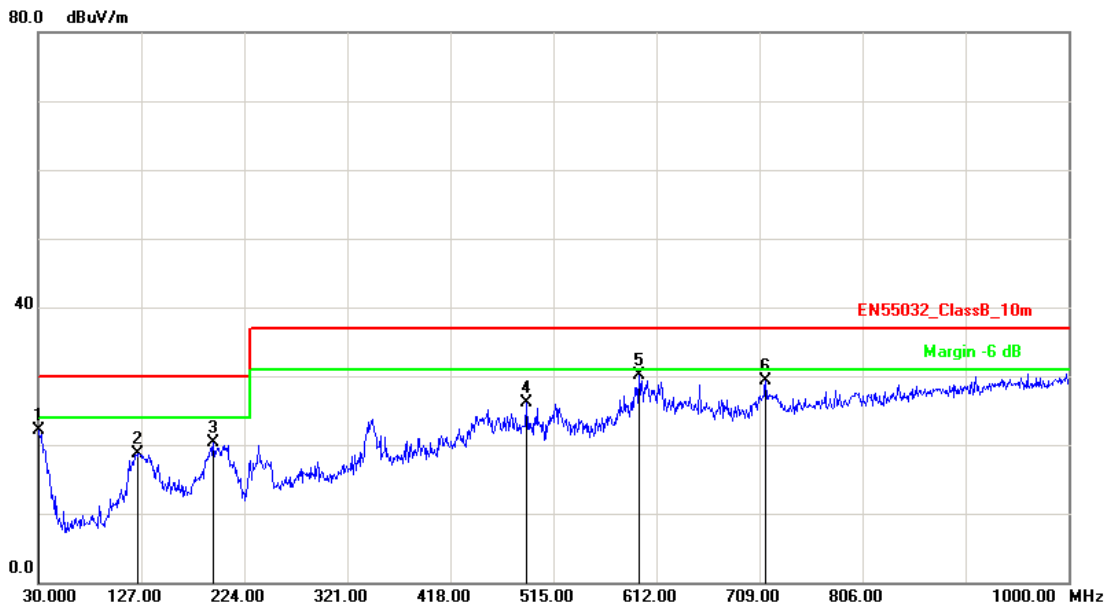

No.	Frequency (MHz)	Factor (dB/m)	Reading (dBuV)	Level (dBuV/m)	Limit (dBuV/m)	Margin (dB)	Det.	Height (cm)	Azimuth (deg)
1	30.0000	-3.26	25.31	22.05	30.00	-7.95	peak	100	268
2	123.1200	-9.69	28.48	18.79	30.00	-11.21	peak	400	147
3	194.9000	-10.32	30.55	20.23	30.00	-9.77	peak	100	26
4	489.7798	-3.34	29.35	26.01	37.00	-10.99	peak	100	0
5	595.5099	-1.31	31.38	30.07	37.00	-6.93	peak	400	301
6	714.8200	0.20	29.05	29.25	37.00	-7.75	peak	100	61

Note: Measurement Level = Reading Level + Correct Factor



Test Mode :	Mode 20: Full system (VGA mode 1920*1080@144Hz) Signal from PC for Horizontal (110V/60Hz)		
AC Power :	AC 110V/60Hz	Ant. Polarization:	Vertical
Equipment :	LCD Monitor	Model No :	*2590*****
Temperature :	25°C	Humidity :	52%
Pressure(mbar) :	1001	Date:	2017/10/22

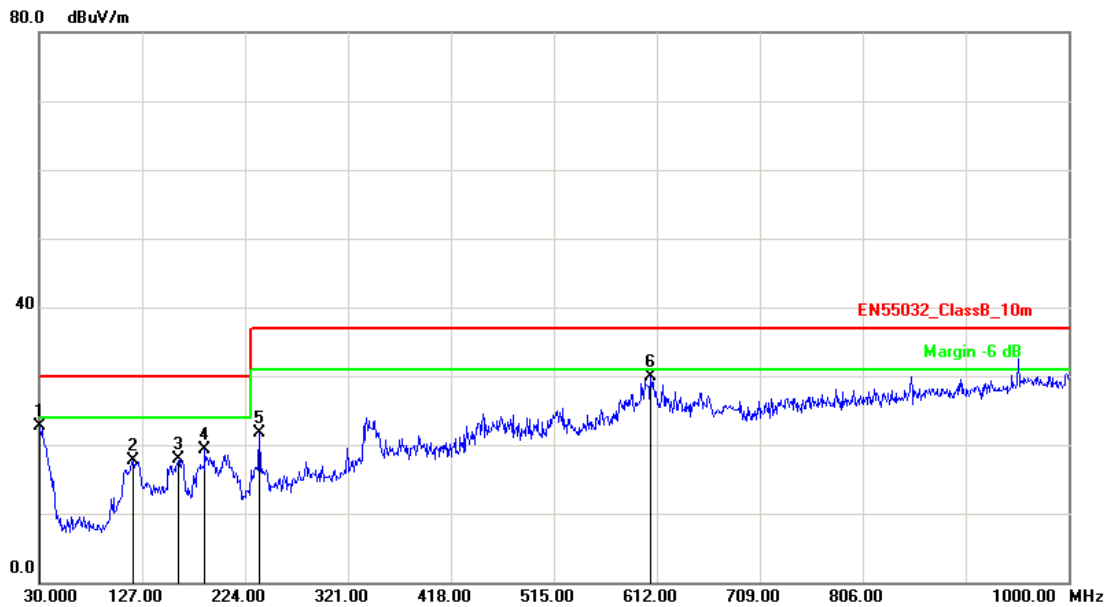

No.	Frequency (MHz)	Factor (dB/m)	Reading (dBuV)	Level (dBuV/m)	Limit (dBuV/m)	Margin (dB)	Det.	Height (cm)	Azimuth (deg)
1	30.9699	-3.96	26.65	22.69	30.00	-7.31	peak	100	284
2	118.2699	-9.92	27.62	17.70	30.00	-12.30	peak	400	59
3	161.9199	-10.92	28.90	17.98	30.00	-12.02	peak	100	62
4	186.1699	-11.00	30.29	19.29	30.00	-10.71	peak	100	305
5	237.5800	-10.98	32.63	21.65	37.00	-15.35	peak	400	124
6	606.1798	-1.16	31.03	29.87	37.00	-7.13	peak	100	0

Note: Measurement Level = Reading Level + Correct Factor



Test Mode :	Mode 21: Full system (HDMI 1 mode 1920*1080@144Hz) Signal from PC for Horizontal (110V/60Hz)		
AC Power :	AC 110V/60Hz	Ant. Polarization:	Horizontal
Equipment :	LCD Monitor	Model No :	*2590*****
Temperature :	25°C	Humidity :	52%
Pressure(mbar) :	1001	Date:	2017/10/22

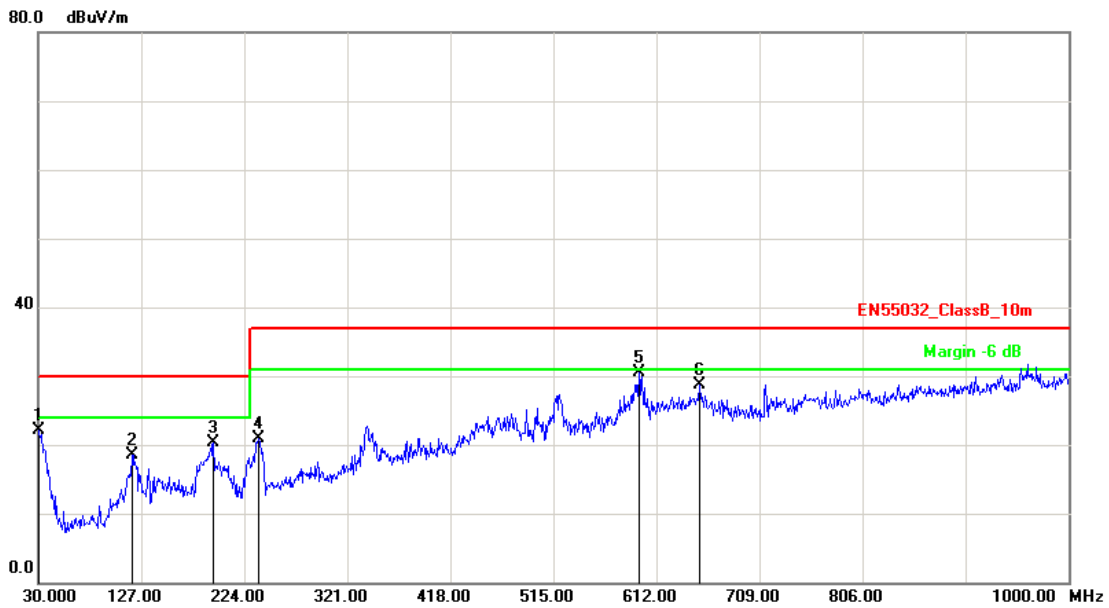

No.	Frequency (MHz)	Factor (dB/m)	Reading (dBUV)	Level (dBUV/m)	Limit (dBUV/m)	Margin (dB)	Det.	Height (cm)	Azimuth (deg)
1	30.0000	-3.26	25.31	22.05	30.00	-7.95	peak	100	124
2	118.2699	-9.92	28.49	18.57	30.00	-11.43	peak	400	157
3	194.9000	-10.32	30.55	20.23	30.00	-9.77	peak	100	49
4	237.5800	-10.98	31.81	20.83	37.00	-16.17	peak	100	215
5	595.5099	-1.31	31.88	30.57	37.00	-6.43	peak	400	60
6	652.7400	-0.26	28.93	28.67	37.00	-8.33	peak	100	301

Note: Measurement Level = Reading Level + Correct Factor



Test Mode :	Mode 21: Full system (HDMI 1 mode 1920*1080@144Hz) Signal from PC for Horizontal (110V/60Hz)		
AC Power :	AC 110V/60Hz	Ant. Polarization:	Vertical
Equipment :	LCD Monitor	Model No :	*2590*****
Temperature :	25°C	Humidity :	52%
Pressure(mbar) :	1001	Date:	2017/10/22

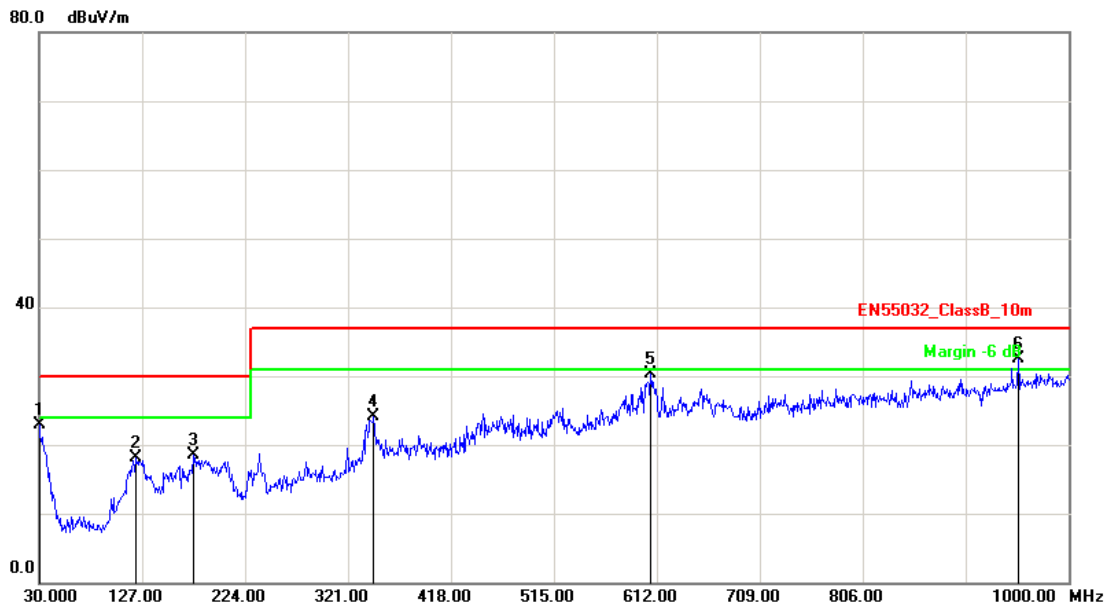

No.	Frequency (MHz)	Factor (dB/m)	Reading (dBuV)	Level (dBuV/m)	Limit (dBuV/m)	Margin (dB)	Det.	Height (cm)	Azimuth (deg)
1	30.0000	-3.26	26.14	22.88	30.00	-7.12	peak	400	214
2	121.1800	-9.60	27.61	18.01	30.00	-11.99	peak	100	157
3	175.5000	-11.34	29.89	18.55	30.00	-11.45	peak	100	185
4	345.2500	-7.55	31.61	24.06	37.00	-12.94	peak	400	265
5	606.1798	-1.16	31.53	30.37	37.00	-6.63	peak	100	32
6	952.4700	4.19	28.35	32.54	37.00	-4.46	peak	100	301

Note: Measurement Level = Reading Level + Correct Factor



Test Mode :	Mode 22: Full system (HDMI 2 mode 1920*1080@144Hz) Signal from PC for Horizontal (110V/60Hz)		
AC Power :	AC 110V/60Hz	Ant. Polarization:	Horizontal
Equipment :	LCD Monitor	Model No :	*2590*****
Temperature :	25°C	Humidity :	52%
Pressure(mbar) :	1001	Date:	2017/10/22

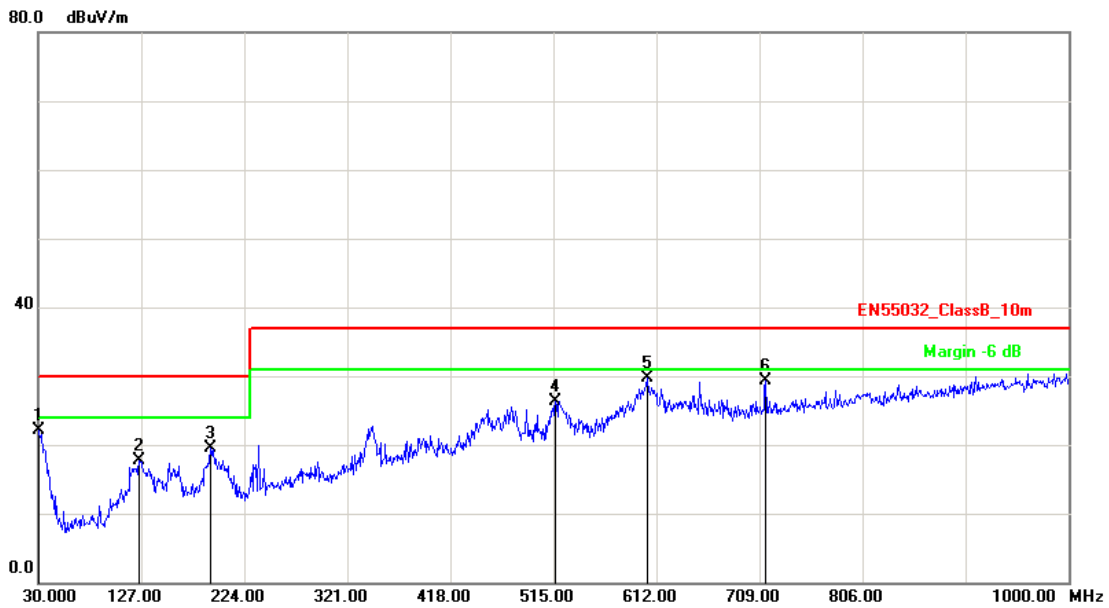

No.	Frequency (MHz)	Factor (dB/m)	Reading (dBuV)	Level (dBuV/m)	Limit (dBuV/m)	Margin (dB)	Det.	Height (cm)	Azimuth (deg)
1	30.0000	-3.26	25.31	22.05	30.00	-7.95	peak	400	215
2	125.0600	-9.77	27.50	17.73	30.00	-12.27	peak	100	4
3	191.9900	-10.54	30.08	19.54	30.00	-10.46	peak	100	298
4	516.9400	-2.68	29.00	26.32	37.00	-10.68	peak	100	125
5	603.2698	-1.20	30.94	29.74	37.00	-7.26	peak	100	314
6	714.8200	0.20	29.05	29.25	37.00	-7.75	peak	400	121

Note: Measurement Level = Reading Level + Correct Factor



Test Mode :	Mode 22: Full system (HDMI 2 mode 1920*1080@144Hz) Signal from PC for Horizontal (110V/60Hz)		
AC Power :	AC 110V/60Hz	Ant. Polarization:	Vertical
Equipment :	LCD Monitor	Model No :	*2590*****
Temperature :	25°C	Humidity :	52%
Pressure(mbar) :	1001	Date:	2017/10/22

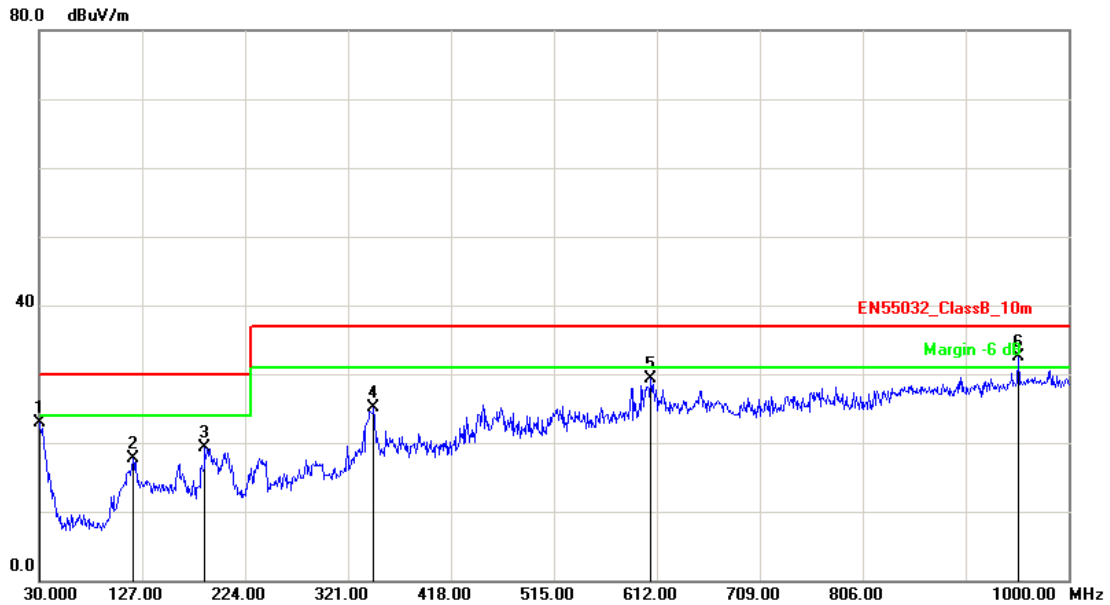

No.	Frequency (MHz)	Factor (dB/m)	Reading (dBuV)	Level (dBuV/m)	Limit (dBuV/m)	Margin (dB)	Det.	Height (cm)	Azimuth (deg)
1	30.0000	-3.26	26.14	22.88	30.00	-7.12	peak	100	184
2	118.2699	-9.92	27.62	17.70	30.00	-12.30	peak	100	168
3	186.1699	-11.00	30.29	19.29	30.00	-10.71	peak	400	265
4	345.2500	-7.55	32.61	25.06	37.00	-11.94	peak	100	215
5	606.1798	-1.16	30.53	29.37	37.00	-7.63	peak	400	125
6	952.4700	4.19	28.35	32.54	37.00	-4.46	peak	100	305

Note: Measurement Level = Reading Level + Correct Factor



5.6. Test Result and Data (1000MHz ~ 6000MHz)

Test Mode :	Mode 1: Full system (Display mode 1920*1080@144Hz) Signal from PC for Horizontal (230V/50Hz)		
AC Power :	AC 230V/50Hz	Ant. Polarization:	Horizontal
Equipment :	LCD Monitor	Model No :	*2590*****
Temperature :	25°C	Humidity :	52%
Pressure(mbar) :	1001	Date:	2017/10/22

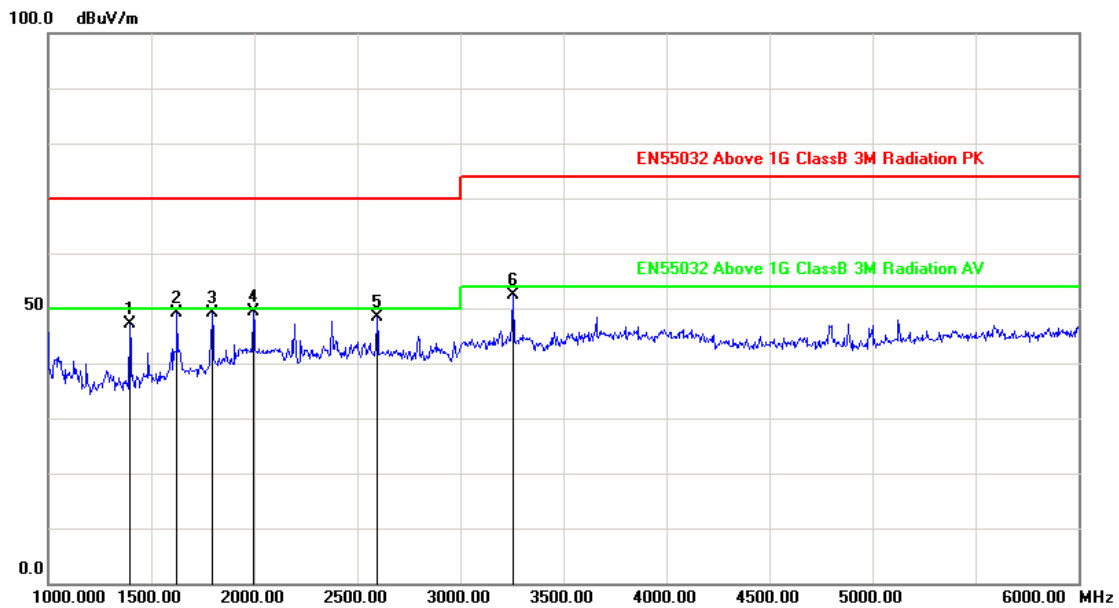

No.	Frequency (MHz)	Factor (dB/m)	Reading (dBuV)	Level (dBuV/m)	Limit (dBuV/m)	Margin (dB)	Det.	Height (cm)	Azimuth (deg)
1	1395.000	-6.93	54.07	47.14	70.00	-22.86	peak	100	265
2	1625.000	-5.49	54.53	49.04	70.00	-20.96	peak	200	84
3	1795.000	-4.42	53.56	49.14	70.00	-20.86	peak	100	154
4	1995.000	-3.15	52.64	49.49	70.00	-20.51	peak	100	26
5	2595.000	-1.03	49.31	48.28	70.00	-21.72	peak	200	302
6	3255.000	1.08	51.34	52.42	74.00	-21.58	peak	100	15

Note: Measurement Level = Reading Level + Correct Factor



Test Mode :	Mode 1: Full system (Display mode 1920*1080@144Hz) Signal from PC for Horizontal (230V/50Hz)		
AC Power :	AC 230V/50Hz	Ant. Polarization:	Vertical
Equipment :	LCD Monitor	Model No :	*2590*****
Temperature :	25°C	Humidity :	52%
Pressure(mbar) :	1001	Date:	2017/10/22

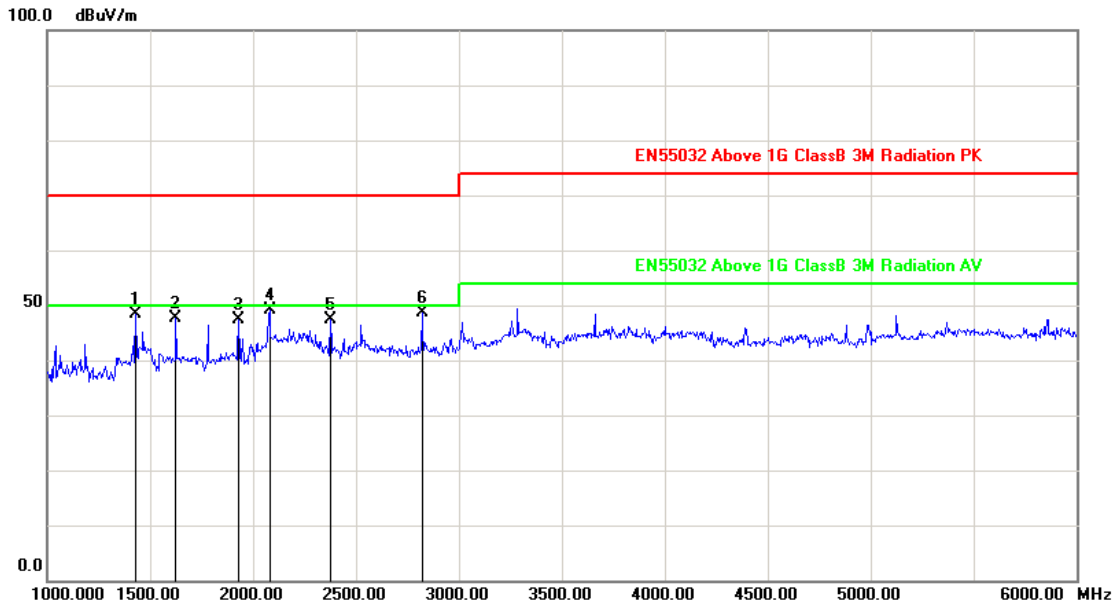

No.	Frequency (MHz)	Factor (dB/m)	Reading (dBuV)	Level (dBuV/m)	Limit (dBuV/m)	Margin (dB)	Det.	Height (cm)	Azimuth (deg)
1	1430.000	-6.71	55.14	48.43	70.00	-21.57	peak	200	268
2	1625.000	-5.49	53.05	47.56	70.00	-22.44	peak	100	157
3	1930.000	-3.56	50.94	47.38	70.00	-22.62	peak	100	194
4	2080.000	-2.82	51.93	49.11	70.00	-20.89	peak	200	65
5	2375.000	-1.73	48.99	47.26	70.00	-22.74	peak	200	303
6	2820.000	-0.46	48.97	48.51	70.00	-21.49	peak	100	156

Note: Measurement Level = Reading Level + Correct Factor



Test Mode :	Mode 5: Full system (VGA mode 1920*1080@144Hz) Signal from PC for Horizontal (230V/50Hz)		
AC Power :	AC 230V/50Hz	Ant. Polarization:	Horizontal
Equipment :	LCD Monitor	Model No :	*2590*****
Temperature :	25°C	Humidity :	52%
Pressure(mbar) :	1001	Date:	2017/10/22

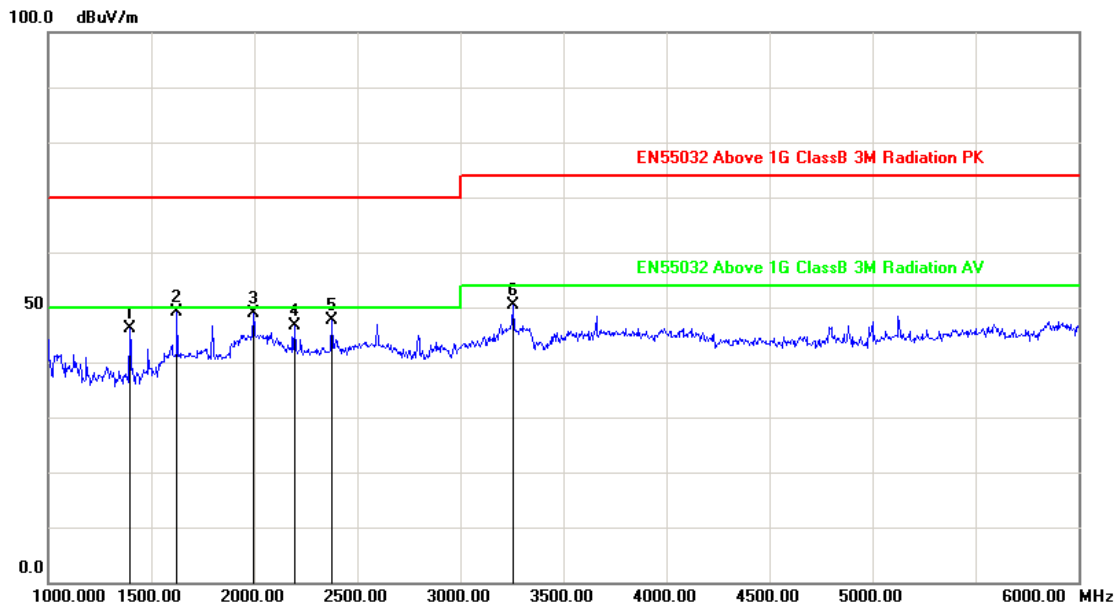

No.	Frequency (MHz)	Factor (dB/m)	Reading (dBuV)	Level (dBuV/m)	Limit (dBuV/m)	Margin (dB)	Det.	Height (cm)	Azimuth (deg)
1	1395.000	-6.93	53.07	46.14	70.00	-23.86	peak	100	325
2	1625.000	-5.49	54.53	49.04	70.00	-20.96	peak	200	124
3	1995.000	-3.15	52.14	48.99	70.00	-21.01	peak	100	78
4	2195.000	-2.40	49.08	46.68	70.00	-23.32	peak	200	158
5	2375.000	-1.73	49.44	47.71	70.00	-22.29	peak	100	165
6	3255.000	1.08	49.34	50.42	74.00	-23.58	peak	100	2

Note: Measurement Level = Reading Level + Correct Factor



Test Mode :	Mode 5: Full system (VGA mode 1920*1080@144Hz) Signal from PC for Horizontal (230V/50Hz)		
AC Power :	AC 230V/50Hz	Ant. Polarization:	Vertical
Equipment :	LCD Monitor	Model No :	*2590*****
Temperature :	25°C	Humidity :	52%
Pressure(mbar) :	1001	Date:	2017/10/22

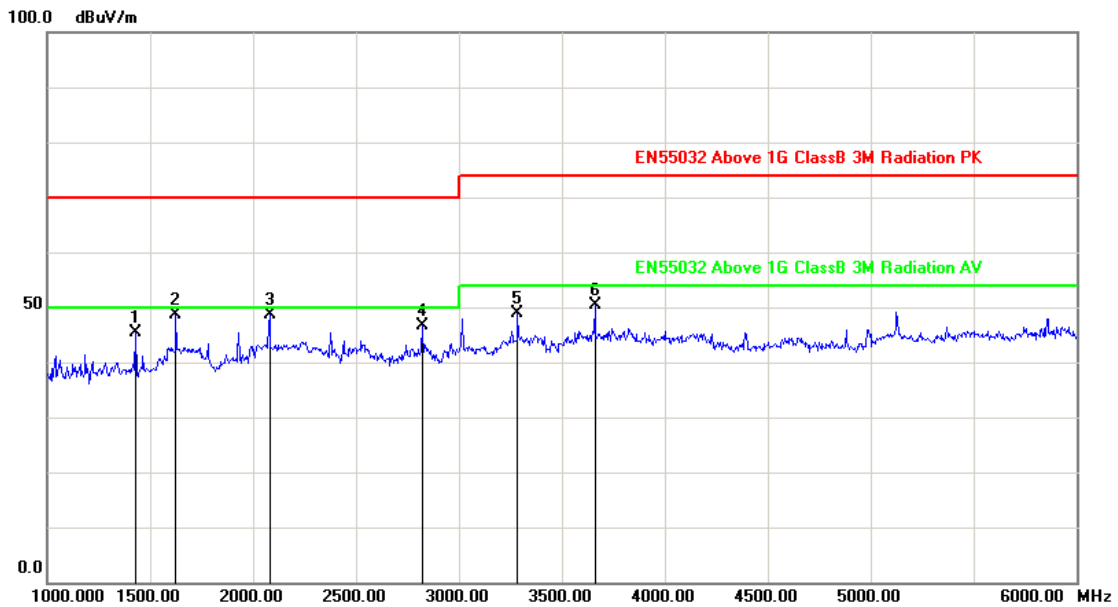

No.	Frequency (MHz)	Factor (dB/m)	Reading (dBuV)	Level (dBuV/m)	Limit (dBuV/m)	Margin (dB)	Det.	Height (cm)	Azimuth (deg)
1	1430.000	-6.71	52.14	45.43	70.00	-24.57	peak	200	214
2	1625.000	-5.49	54.05	48.56	70.00	-21.44	peak	100	57
3	2080.000	-2.82	51.43	48.61	70.00	-21.39	peak	100	49
4	2820.000	-0.46	46.97	46.51	70.00	-23.49	peak	200	68
5	3285.000	1.20	47.75	48.95	74.00	-25.05	peak	200	258
6	3660.000	2.70	47.59	50.29	74.00	-23.71	peak	100	154

Note: Measurement Level = Reading Level + Correct Factor



Test Mode :	Mode 9: Full system (HDMI 1 mode 1920*1080@144Hz) Signal from PC for Horizontal (230V/50Hz)		
AC Power :	AC 230V/50Hz	Ant. Polarization:	Horizontal
Equipment :	LCD Monitor	Model No :	*2590*****
Temperature :	25°C	Humidity :	52%
Pressure(mbar) :	1001	Date:	2017/10/22

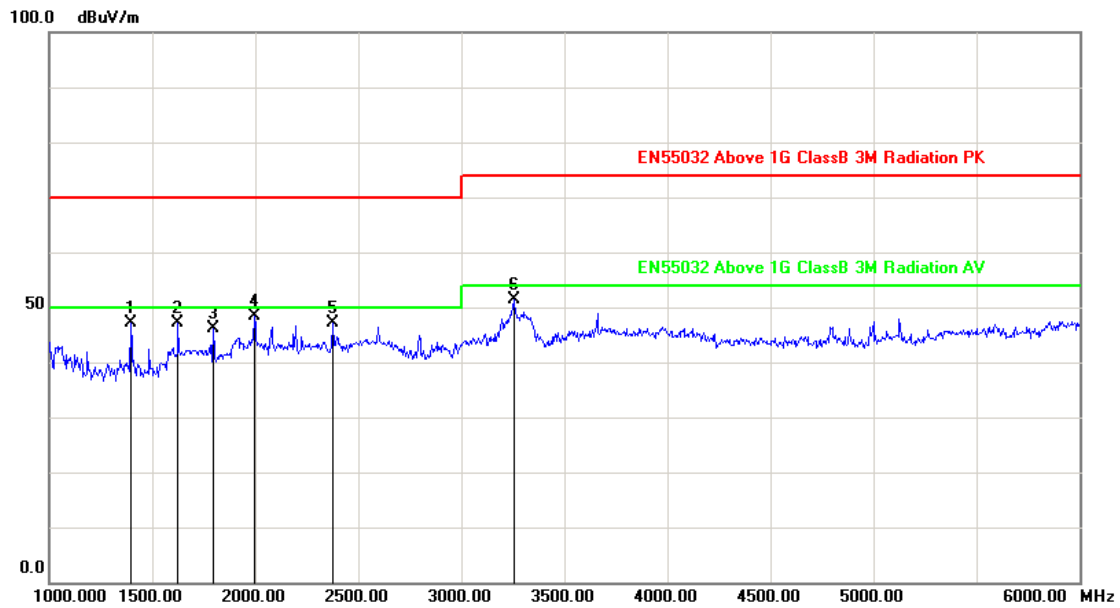

No.	Frequency (MHz)	Factor (dB/m)	Reading (dBuV)	Level (dBuV/m)	Limit (dBuV/m)	Margin (dB)	Det.	Height (cm)	Azimuth (deg)
1	1395.000	-6.93	54.07	47.14	70.00	-22.86	peak	100	326
2	1625.000	-5.49	52.53	47.04	70.00	-22.96	peak	200	124
3	1795.000	-4.42	50.56	46.14	70.00	-23.86	peak	100	75
4	1995.000	-3.15	51.64	48.49	70.00	-21.51	peak	100	81
5	2375.000	-1.73	48.94	47.21	70.00	-22.79	peak	200	194
6	3255.000	1.08	50.34	51.42	74.00	-22.58	peak	100	2

Note: Measurement Level = Reading Level + Correct Factor



Test Mode :	Mode 9: Full system (HDMI 1 mode 1920*1080@144Hz) Signal from PC for Horizontal (230V/50Hz)		
AC Power :	AC 230V/50Hz	Ant. Polarization:	Vertical
Equipment :	LCD Monitor	Model No :	*2590*****
Temperature :	25°C	Humidity :	52%
Pressure(mbar) :	1001	Date:	2017/10/22

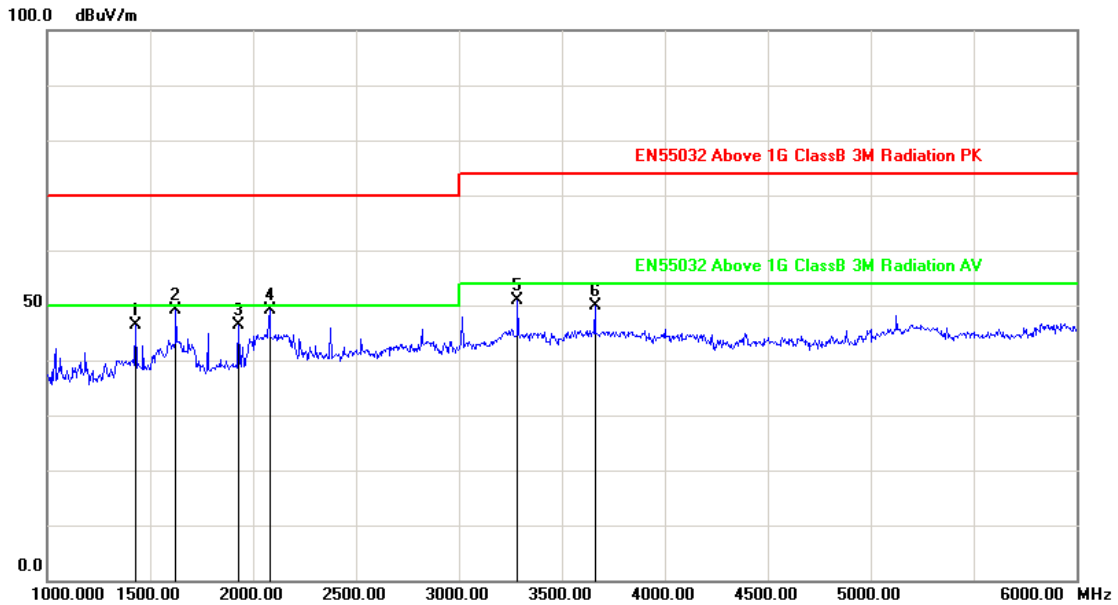

No.	Frequency (MHz)	Factor (dB/m)	Reading (dBuV)	Level (dBuV/m)	Limit (dBuV/m)	Margin (dB)	Det.	Height (cm)	Azimuth (deg)
1	1430.000	-6.71	53.14	46.43	70.00	-23.57	peak	200	214
2	1625.000	-5.49	54.55	49.06	70.00	-20.94	peak	100	71
3	1930.000	-3.56	49.94	46.38	70.00	-23.62	peak	100	48
4	2080.000	-2.82	51.93	49.11	70.00	-20.89	peak	200	168
5	3285.000	1.20	49.75	50.95	74.00	-23.05	peak	200	155
6	3660.000	2.70	47.09	49.79	74.00	-24.21	peak	100	18

Note: Measurement Level = Reading Level + Correct Factor



Test Mode :	Mode 14: Full system (HDMI 2 mode 1920*1080@144Hz) Signal from PC for Horizontal (230V/50Hz)		
AC Power :	AC 230V/50Hz	Ant. Polarization:	Horizontal
Equipment :	LCD Monitor	Model No :	*2590*****
Temperature :	25°C	Humidity :	52%
Pressure(mbar) :	1001	Date:	2017/10/22

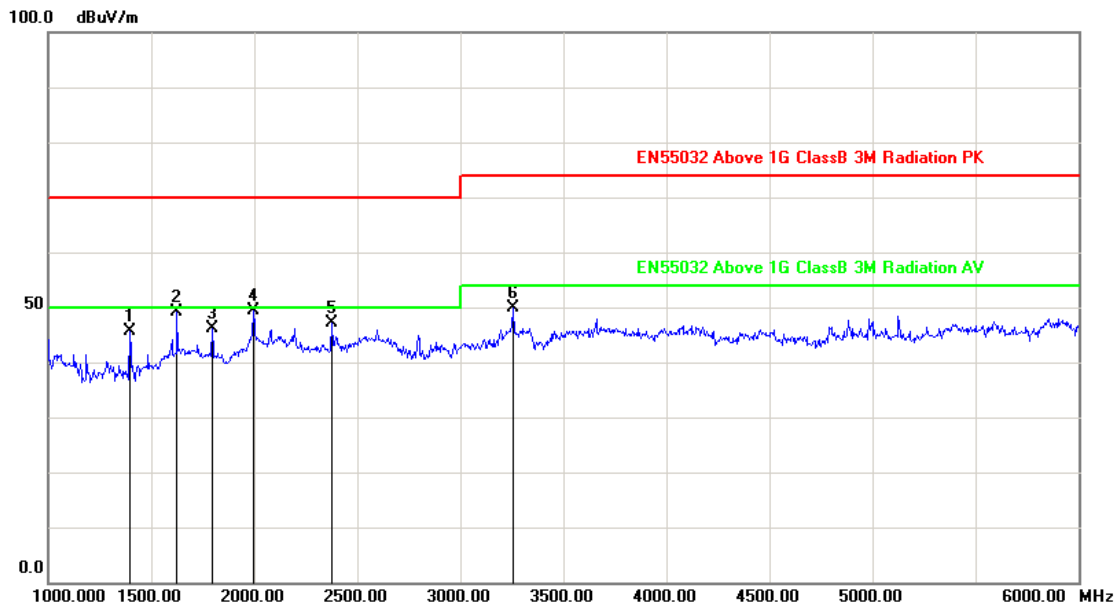

No.	Frequency (MHz)	Factor (dB/m)	Reading (dBuV)	Level (dBuV/m)	Limit (dBuV/m)	Margin (dB)	Det.	Height (cm)	Azimuth (deg)
1	1395.000	-6.93	52.57	45.64	70.00	-24.36	peak	100	326
2	1625.000	-5.49	54.53	49.04	70.00	-20.96	peak	200	124
3	1795.000	-4.42	50.56	46.14	70.00	-23.86	peak	100	18
4	1995.000	-3.15	52.64	49.49	70.00	-20.51	peak	100	256
5	2375.000	-1.73	48.94	47.21	70.00	-22.79	peak	200	19
6	3255.000	1.08	48.84	49.92	74.00	-24.08	peak	100	129

Note: Measurement Level = Reading Level + Correct Factor



Test Mode :	Mode 14: Full system (HDMI 2 mode 1920*1080@144Hz) Signal from PC for Horizontal (230V/50Hz)		
AC Power :	AC 230V/50Hz	Ant. Polarization:	Vertical
Equipment :	LCD Monitor	Model No :	*2590*****
Temperature :	25°C	Humidity :	52%
Pressure(mbar) :	1001	Date:	2017/10/22

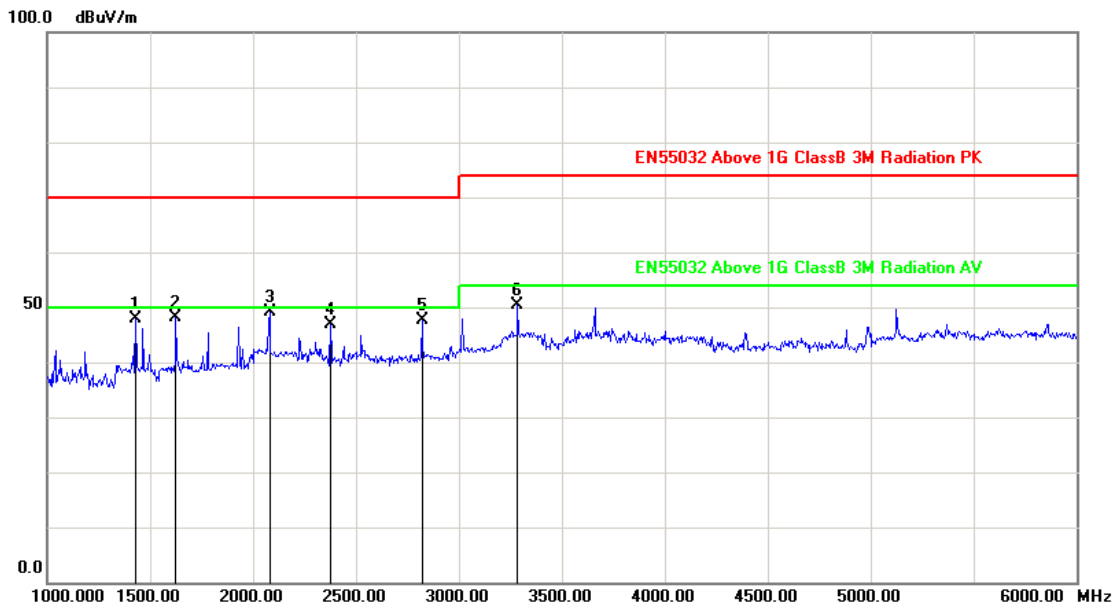

No.	Frequency (MHz)	Factor (dB/m)	Reading (dBuV)	Level (dBuV/m)	Limit (dBuV/m)	Margin (dB)	Det.	Height (cm)	Azimuth (deg)
1	1430.000	-6.71	54.64	47.93	70.00	-22.07	peak	200	325
2	1625.000	-5.49	53.55	48.06	70.00	-21.94	peak	100	124
3	2080.000	-2.82	51.93	49.11	70.00	-20.89	peak	200	81
4	2375.000	-1.73	48.49	46.76	70.00	-23.24	peak	200	198
5	2820.000	-0.46	47.97	47.51	70.00	-22.49	peak	100	265
6	3285.000	1.20	49.25	50.45	74.00	-23.55	peak	200	205

Note: Measurement Level = Reading Level + Correct Factor



Test Mode :	Mode 19: Full system (Display mode 1920*1080@144Hz) Signal from PC for Horizontal (110V/60Hz)		
AC Power :	AC 110V/60Hz	Ant. Polarization:	Horizontal
Equipment :	LCD Monitor	Model No :	*2590*****
Temperature :	25°C	Humidity :	52%
Pressure(mbar) :	1001	Date:	2017/10/22

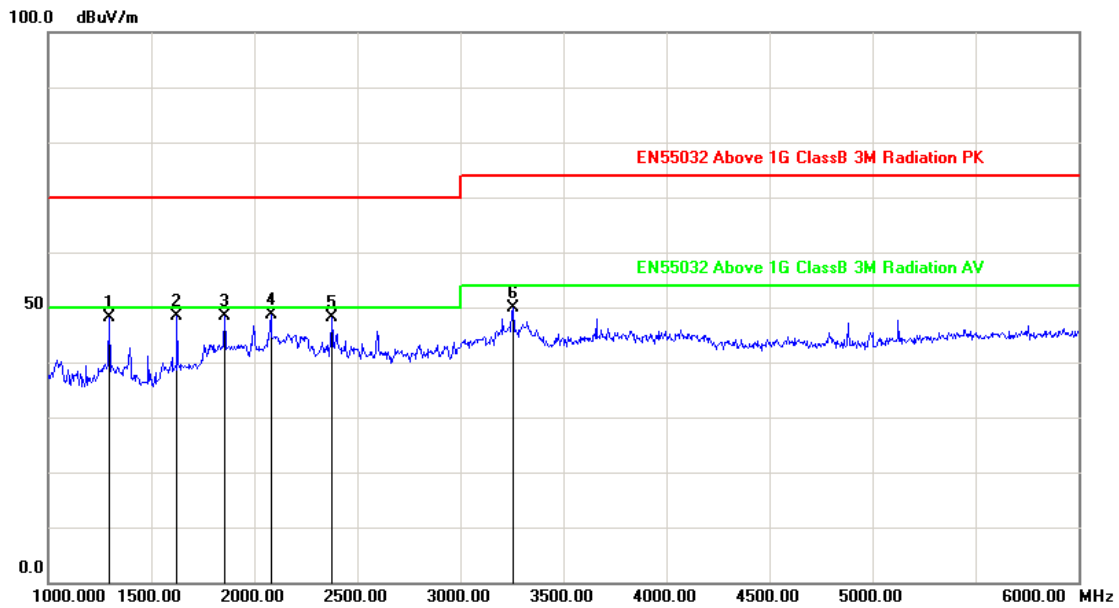

No.	Frequency (MHz)	Factor (dB/m)	Reading (dBuV)	Level (dBuV/m)	Limit (dBuV/m)	Margin (dB)	Det.	Height (cm)	Azimuth (deg)
1	1295.000	-7.55	55.64	48.09	70.00	-21.91	peak	100	258
2	1625.000	-5.49	53.82	48.33	70.00	-21.67	peak	200	197
3	1855.000	-4.04	52.49	48.45	70.00	-21.55	peak	100	174
4	2080.000	-2.82	51.55	48.73	70.00	-21.27	peak	100	195
5	2375.000	-1.73	49.79	48.06	70.00	-21.94	peak	200	65
6	3255.000	1.08	48.85	49.93	74.00	-24.07	peak	100	48

Note: Measurement Level = Reading Level + Correct Factor



Test Mode :	Mode 19: Full system (Display mode 1920*1080@144Hz) Signal from PC for Horizontal (110V/60Hz)		
AC Power :	AC 110V/60Hz	Ant. Polarization:	Vertical
Equipment :	LCD Monitor	Model No :	*2590*****
Temperature :	25°C	Humidity :	52%
Pressure(mbar) :	1001	Date:	2017/10/22

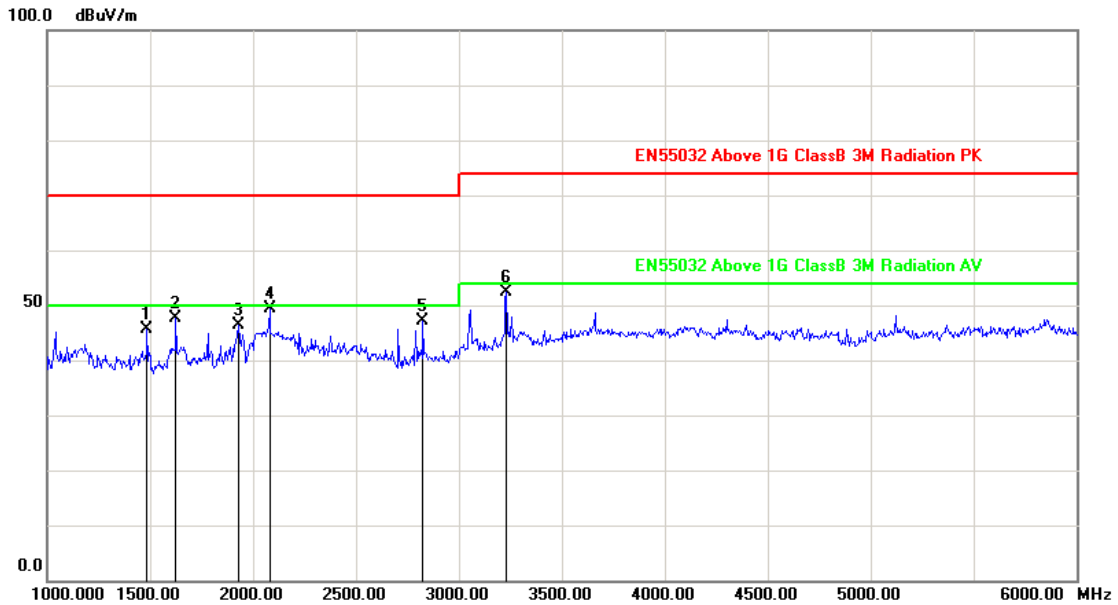

No.	Frequency (MHz)	Factor (dB/m)	Reading (dBuV)	Level (dBuV/m)	Limit (dBuV/m)	Margin (dB)	Det.	Height (cm)	Azimuth (deg)
1	1485.000	-6.37	51.97	45.60	70.00	-24.40	peak	200	259
2	1625.000	-5.49	53.10	47.61	70.00	-22.39	peak	100	124
3	1930.000	-3.56	49.85	46.29	70.00	-23.71	peak	200	187
4	2080.000	-2.82	52.12	49.30	70.00	-20.70	peak	200	152
5	2825.000	-0.44	47.56	47.12	70.00	-22.88	peak	100	6
6	3230.000	0.97	51.32	52.29	74.00	-21.71	peak	100	325

Note: Measurement Level = Reading Level + Correct Factor



Test Mode :	Mode 20: Full system (VGA mode 1920*1080@144Hz) Signal from PC for Horizontal (110V/60Hz)		
AC Power :	AC 110V/60Hz	Ant. Polarization:	Horizontal
Equipment :	LCD Monitor	Model No :	*2590*****
Temperature :	25°C	Humidity :	52%
Pressure(mbar) :	1001	Date:	2017/10/22

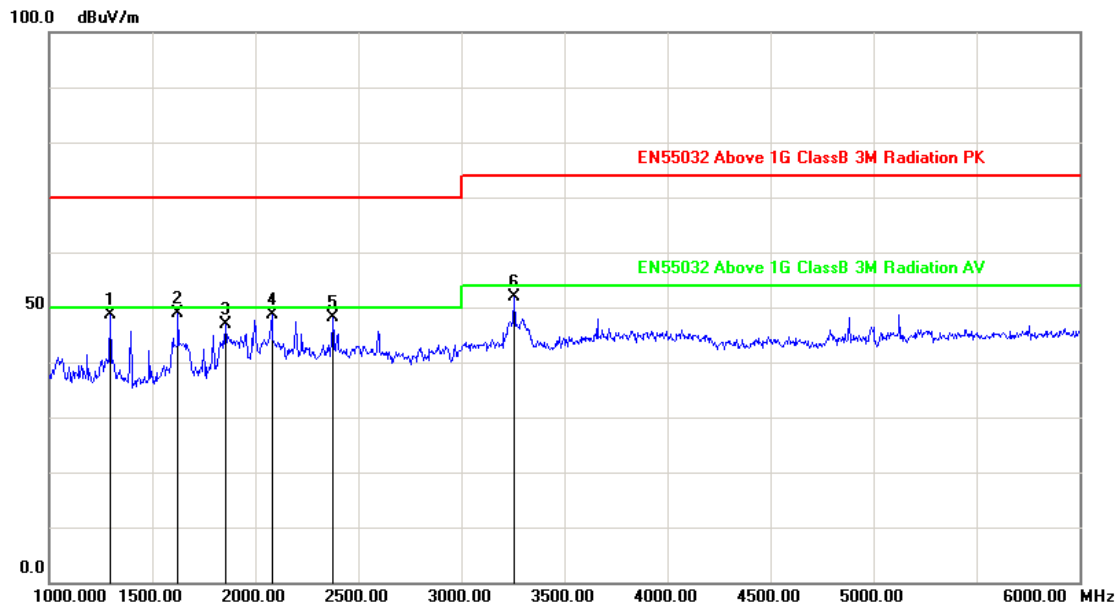

No.	Frequency (MHz)	Factor (dB/m)	Reading (dBuV)	Level (dBuV/m)	Limit (dBuV/m)	Margin (dB)	Det.	Height (cm)	Azimuth (deg)
1	1295.000	-7.55	56.14	48.59	70.00	-21.41	peak	100	325
2	1625.000	-5.49	54.32	48.83	70.00	-21.17	peak	200	124
3	1855.000	-4.04	50.99	46.95	70.00	-23.05	peak	100	18
4	2080.000	-2.82	51.55	48.73	70.00	-21.27	peak	200	57
5	2375.000	-1.73	49.79	48.06	70.00	-21.94	peak	100	168
6	3255.000	1.08	50.85	51.93	74.00	-22.07	peak	100	192

Note: Measurement Level = Reading Level + Correct Factor



Test Mode :	Mode 20: Full system (VGA mode 1920*1080@144Hz) Signal from PC for Horizontal (110V/60Hz)		
AC Power :	AC 110V/60Hz	Ant. Polarization:	Vertical
Equipment :	LCD Monitor	Model No :	*2590*****
Temperature :	25°C	Humidity :	52%
Pressure(mbar) :	1001	Date:	2017/10/22

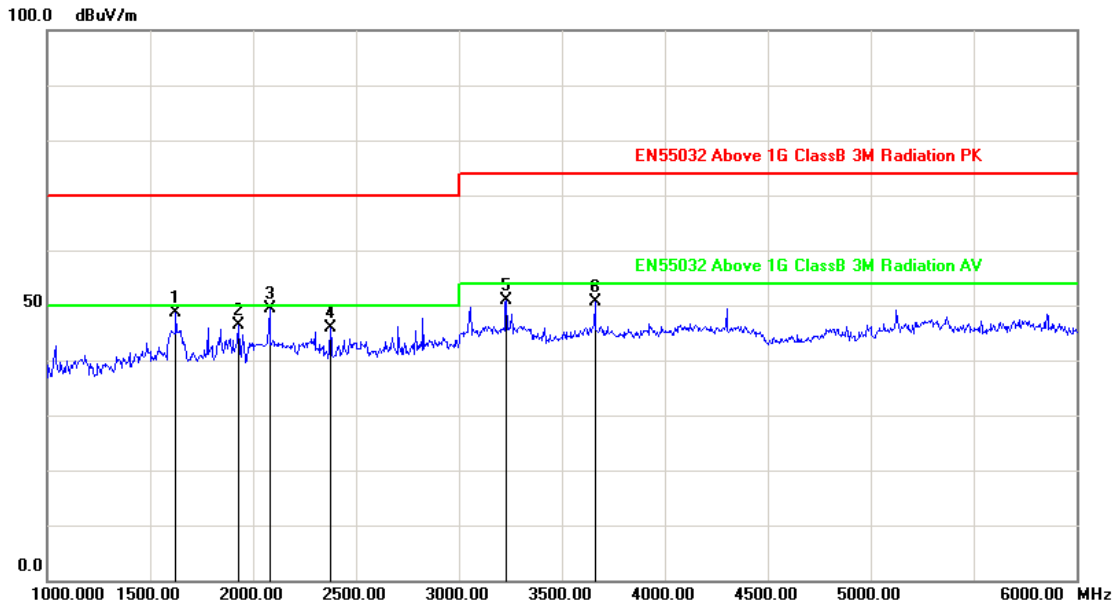

No.	Frequency (MHz)	Factor (dB/m)	Reading (dBuV)	Level (dBuV/m)	Limit (dBuV/m)	Margin (dB)	Det.	Height (cm)	Azimuth (deg)
1	1625.000	-5.49	54.10	48.61	70.00	-21.39	peak	200	259
2	1930.000	-3.56	49.85	46.29	70.00	-23.71	peak	100	127
3	2080.000	-2.82	52.12	49.30	70.00	-20.70	peak	100	185
4	2375.000	-1.73	47.51	45.78	70.00	-24.22	peak	200	165
5	3230.000	0.97	49.82	50.79	74.00	-23.21	peak	200	255
6	3660.000	2.70	47.93	50.63	74.00	-23.37	peak	100	2

Note: Measurement Level = Reading Level + Correct Factor



Test Mode :	Mode 21: Full system (HDMI 1 mode 1920*1080@144Hz) Signal from PC for Horizontal (110V/60Hz)		
AC Power :	AC 110V/60Hz	Ant. Polarization:	Horizontal
Equipment :	LCD Monitor	Model No :	*2590*****
Temperature :	25°C	Humidity :	52%
Pressure(mbar) :	1001	Date:	2017/10/22

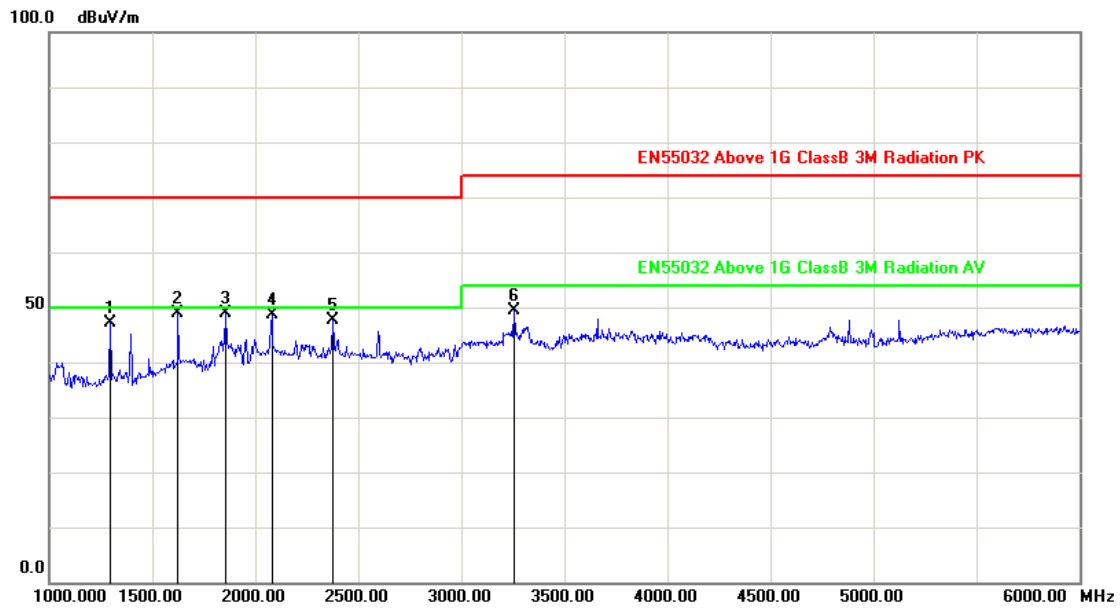

No.	Frequency (MHz)	Factor (dB/m)	Reading (dBuV)	Level (dBuV/m)	Limit (dBuV/m)	Margin (dB)	Det.	Height (cm)	Azimuth (deg)
1	1295.000	-7.55	54.64	47.09	70.00	-22.91	peak	100	258
2	1625.000	-5.49	54.32	48.83	70.00	-21.17	peak	200	157
3	1855.000	-4.04	52.99	48.95	70.00	-21.05	peak	100	149
4	2080.000	-2.82	51.55	48.73	70.00	-21.27	peak	200	268
5	2375.000	-1.73	49.29	47.56	70.00	-22.44	peak	100	151
6	3255.000	1.08	48.35	49.43	74.00	-24.57	peak	100	262

Note: Measurement Level = Reading Level + Correct Factor



Test Mode :	Mode 21: Full system (HDMI 1 mode 1920*1080@144Hz) Signal from PC for Horizontal (110V/60Hz)		
AC Power :	AC 110V/60Hz	Ant. Polarization:	Vertical
Equipment :	LCD Monitor	Model No :	*2590*****
Temperature :	25°C	Humidity :	52%
Pressure(mbar) :	1001	Date:	2017/10/22

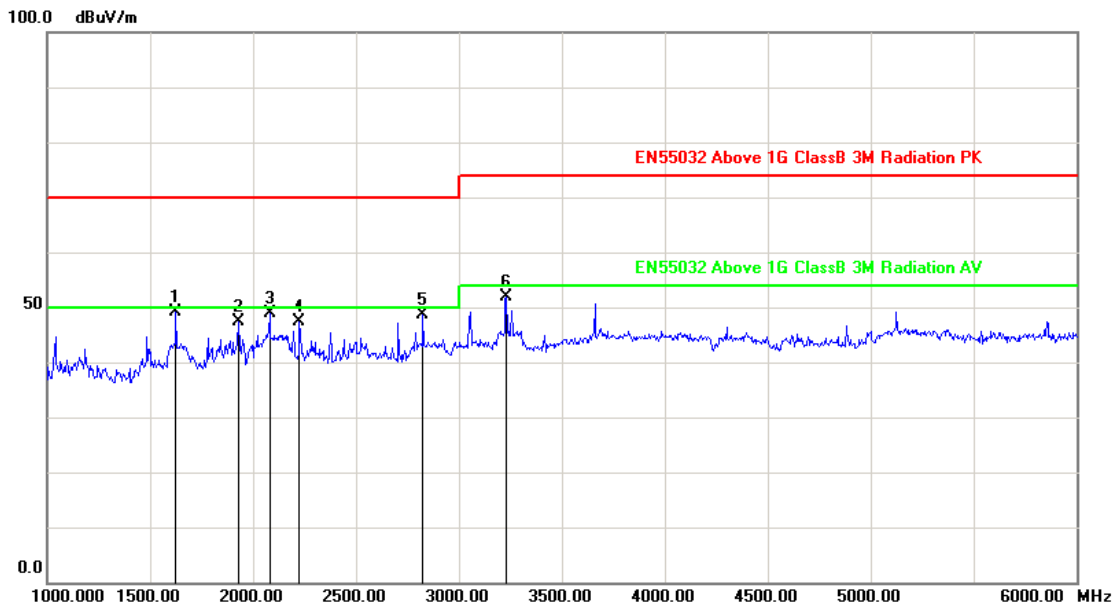

No.	Frequency (MHz)	Factor (dB/m)	Reading (dBuV)	Level (dBuV/m)	Limit (dBuV/m)	Margin (dB)	Det.	Height (cm)	Azimuth (deg)
1	1625.000	-5.49	54.60	49.11	70.00	-20.89	peak	100	125
2	1930.000	-3.56	50.85	47.29	70.00	-22.71	peak	200	192
3	2080.000	-2.82	51.62	48.80	70.00	-21.20	peak	100	326
4	2225.000	-2.29	49.77	47.48	70.00	-22.52	peak	200	54
5	2825.000	-0.44	49.06	48.62	70.00	-21.38	peak	200	135
6	3230.000	0.97	50.82	51.79	74.00	-22.21	peak	100	206

Note: Measurement Level = Reading Level + Correct Factor



Test Mode :	Mode 22: Full system (HDMI 2 mode 1920*1080@144Hz) Signal from PC for Horizontal (110V/60Hz)		
AC Power :	AC 110V/60Hz	Ant. Polarization:	Horizontal
Equipment :	LCD Monitor	Model No :	*2590*****
Temperature :	25°C	Humidity :	52%
Pressure(mbar) :	1001	Date:	2017/10/22

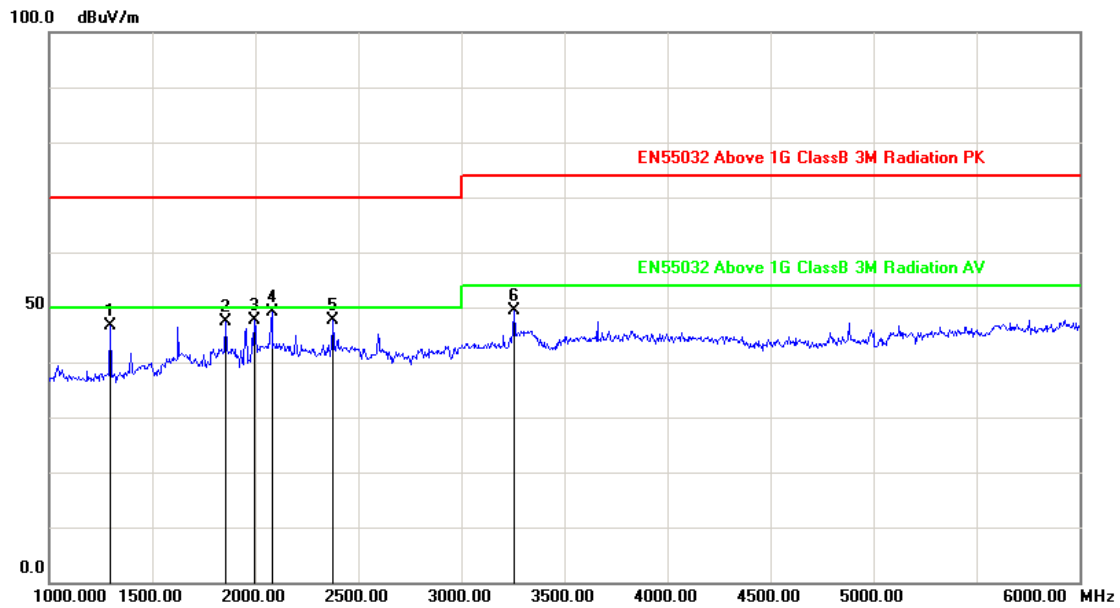

No.	Frequency (MHz)	Factor (dB/m)	Reading (dBuV)	Level (dBuV/m)	Limit (dBuV/m)	Margin (dB)	Det.	Height (cm)	Azimuth (deg)
1	1295.000	-7.55	54.14	46.59	70.00	-23.41	peak	100	258
2	1855.000	-4.04	51.49	47.45	70.00	-22.55	peak	200	124
3	1995.000	-3.15	50.67	47.52	70.00	-22.48	peak	100	174
4	2080.000	-2.82	52.05	49.23	70.00	-20.77	peak	200	195
5	2375.000	-1.73	49.29	47.56	70.00	-22.44	peak	100	265
6	3255.000	1.08	48.35	49.43	74.00	-24.57	peak	100	15

Note: Measurement Level = Reading Level + Correct Factor



Test Mode :	Mode 22: Full system (HDMI 2 mode 1920*1080@144Hz) Signal from PC for Horizontal (110V/60Hz)		
AC Power :	AC 110V/60Hz	Ant. Polarization:	Vertical
Equipment :	LCD Monitor	Model No :	*2590*****
Temperature :	25°C	Humidity :	52%
Pressure(mbar) :	1001	Date:	2017/10/22

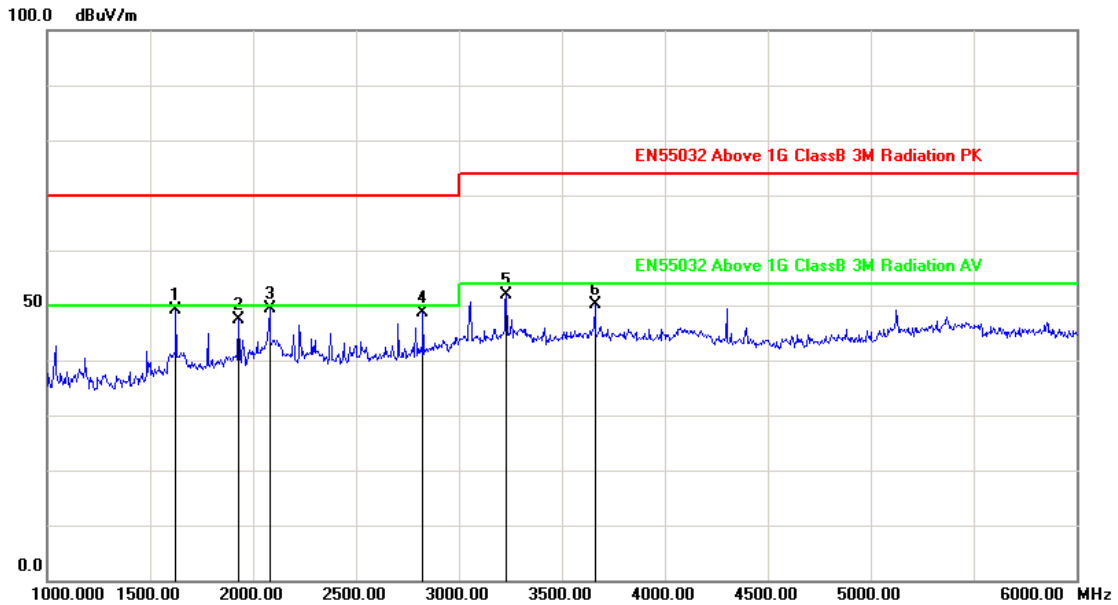

No.	Frequency (MHz)	Factor (dB/m)	Reading (dBuV)	Level (dBuV/m)	Limit (dBuV/m)	Margin (dB)	Det.	Height (cm)	Azimuth (deg)
1	1625.000	-5.49	54.60	49.11	70.00	-20.89	peak	100	352
2	1930.000	-3.56	50.85	47.29	70.00	-22.71	peak	200	124
3	2080.000	-2.82	52.12	49.30	70.00	-20.70	peak	200	198
4	2825.000	-0.44	49.06	48.62	70.00	-21.38	peak	100	244
5	3230.000	0.97	50.82	51.79	74.00	-22.21	peak	100	152
6	3660.000	2.70	47.43	50.13	74.00	-23.87	peak	200	215

Note: Measurement Level = Reading Level + Correct Factor

Test engineer: Sun Zhang



5.7. Test Photographs (30MHz ~ 1000MHz)

Front View



Rear View

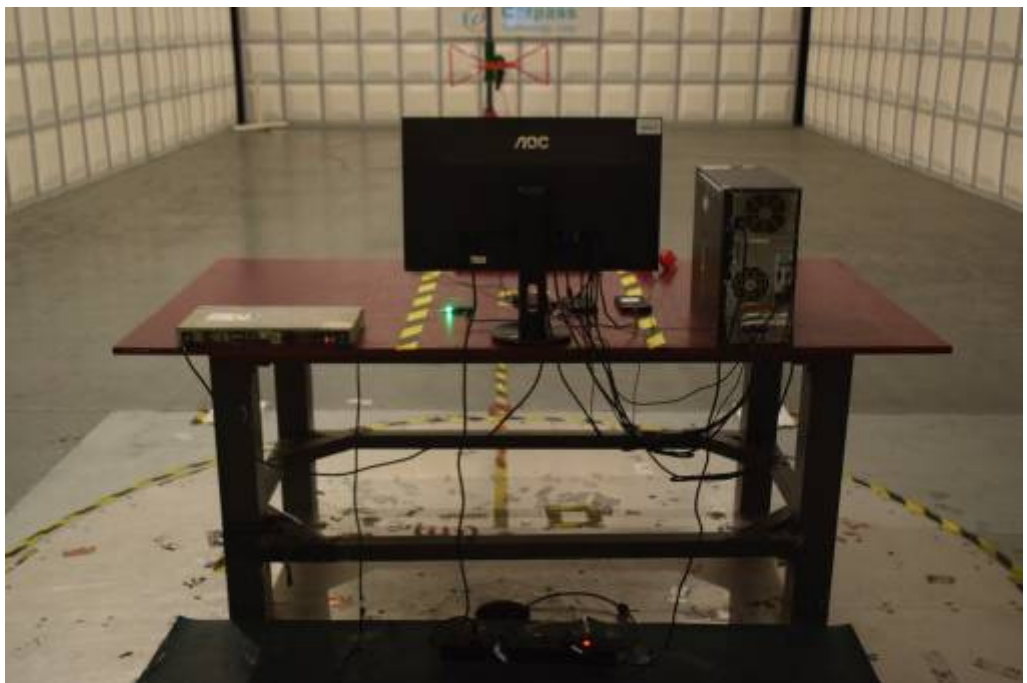



5.8. Test Photographs (1000MHz ~ 6000MHz)

Front View



Rear View

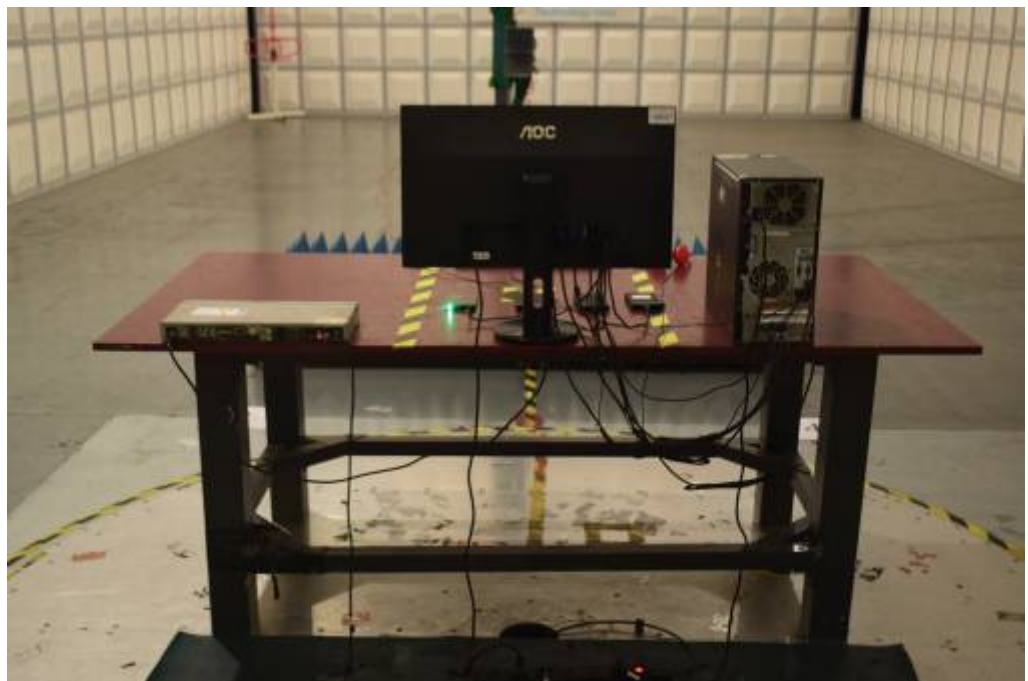



6. Harmonics Test

6.1. Limits Of Harmonics Current Measurement

Limits for Class A equipment

Harmonics Order n	Max. permissible harmonics current A	Harmonics Order n	Max. permissible harmonics current A
Odd harmonics		Even harmonics	
3	2.30	2	1.08
5	1.14	4	0.43
7	0.77	6	0.30
9	0.40	8<=n<=40	0.23x8/n
11	0.33		
13	0.21		
15<=n<=39	0.15x15/n		

(b) Limits for Class B equipment

For Class B equipment, the harmonics of the input current shall not exceed the values given in Table that is the limit of Class A multiplied by a factor of 1,5.

(c) Limits for Class C equipment

Harmonics Order n	Maximum permissible harmonic current expressed as a percentage of the input current at the fundamental frequency %
2	2
3	$30 \cdot \lambda^*$
5	10
7	7
9	5
11<n<39 (odd harmonics only)	3

* λ is the circuit power factor

(d) Limits for Class D equipment

Harmonics Order n	Maximum permissible harmonic current per watt mA/W	Maximum permissible harmonic current A
3	3.4	2.30
5	1.9	1.14
7	1.0	0.77
9	0.5	0.40
11	0.35	0.33
11 < n < 39 (odd harmonics only)	3.85/n	See limit of Class A

NOTE: According to section 7 of EN 61000-3-2, the above limits for all equipment except for lighting equipment having an active input power > 75 W and no limits apply for equipment with an active input power up to and including 75 W.



6.2. Measurement equipment

Instrument/Ancillary	Manufacturer	Model No.	Serial No.	Calibration Date	Valid Date.
EMC Emission Tester	EMCPARTNER	Harmonics-1000	159	2017.07.12	2018.07.11
Temperature/ Humidity Meter	Zhicheng	ZC1-11	CEP-TH-004	2017.03.28	2018.03.27
HARCS	EMC Partner AG	Ver 4.18	N/A	N/A	N/A



6.3. Test Result and Data

Basic Standard	:	EN 61000-3-2
Final Test Result	:	PASS
Test Mode	:	Mode 1,2,3,4
Model No.	:	*2590*****
Temperature	:	22°C
Humidity	:	53 %
Atmospheric Pressure	:	100 kPa
Test Date	:	Oct 22, 2017

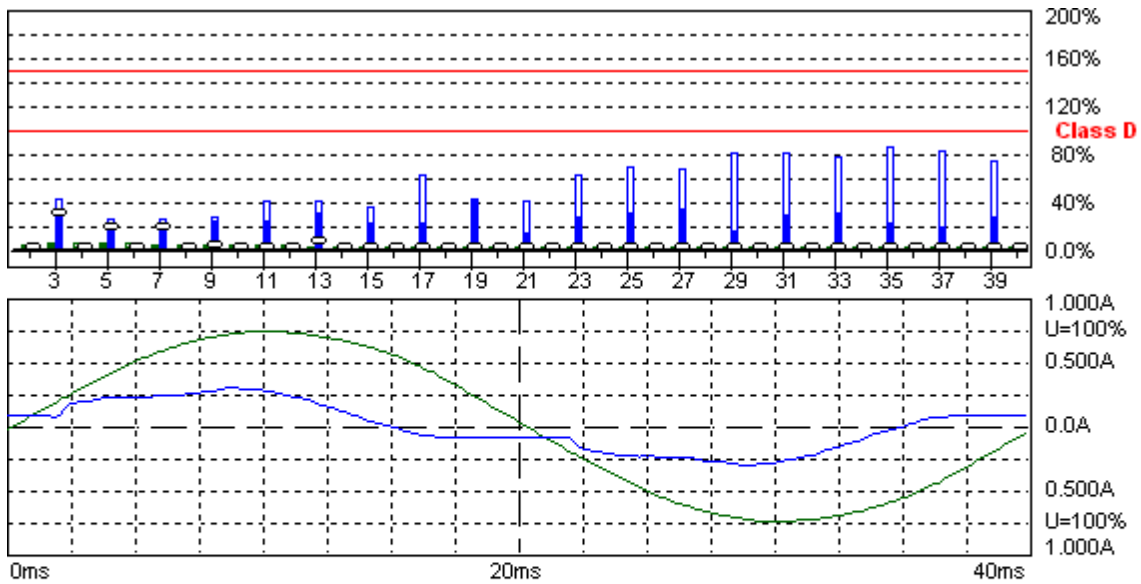

Harmonic Emission - IEC 61000-3-2, EN 61000-3-2, (EN60555-2)

2017-10-22 14:20:35 harmonic.hsu

Urms = 230.1 V P = 33.79 W THC = 0.050 A Range: 1 A
 Irms = 0.183 A pf = 0.802 Pmax = 49.30 W V-nom: 230 V
 TestTime: 15 min (100%)

Test completed, Result: PASSED

HAR-1000 EMC-Parber

Full Bar : Actual Values
 Empty Bar : Maximum Values
 Blue : Current , Green : Voltage , Red : Failed

Urms = 230.1V Freq = 49.987 Range: 1 A
 Irms = 0.183A Ipk = 0.305A cf = 1.667
 P = 33.79W S = 42.13VA pf = 0.802
 THDi = 27.3 % THDu = 1.10 % Class D
 Test - Time : 15min (100 %)
 Limit Reference: Pmax = 49.301W
 Test completed, Result: PASSED



Order	Freq. [Hz]	Iavg [A]	Irms [A]	I _{max} [A]	Limit [A]
1	50	0.1897	0.1768	0.2492	
2	100	0.0007	0.0003	0.0308	
3	150	0.0480	0.0433	0.0687	0.1676
4	200	0.0003	0.0002	0.0139	
5	250	0.0155	0.0154	0.0220	0.0937
6	300	0.0001	0.0002	0.0110	
7	350	0.0084	0.0098	0.0115	0.0493
8	400	0.0000	0.0002	0.0041	
9	450	0.0004	0.0052	0.0063	0.0247
10	500	0.0000	0.0001	0.0051	
11	550	0.0000	0.0037	0.0067	0.0173
12	600	0.0000	0.0002	0.0051	
13	650	0.0008	0.0041	0.0056	0.0146
14	700	0.0000	0.0002	0.0021	
15	750	0.0000	0.0025	0.0042	0.0127
16	800	0.0000	0.0002	0.0050	
17	850	0.0000	0.0022	0.0067	0.0112
18	900	0.0000	0.0002	0.0042	
19	950	0.0000	0.0038	0.0041	0.0100
20	1000	0.0000	0.0002	0.0019	
21	1050	0.0000	0.0011	0.0035	0.0090
22	1100	0.0000	0.0002	0.0039	
23	1150	0.0000	0.0021	0.0050	0.0083
24	1200	0.0000	0.0002	0.0048	
25	1250	0.0000	0.0022	0.0051	0.0076
26	1300	0.0000	0.0002	0.0040	
27	1350	0.0000	0.0022	0.0046	0.0070
28	1400	0.0000	0.0002	0.0046	
29	1450	0.0000	0.0009	0.0051	0.0065
30	1500	0.0000	0.0002	0.0053	
31	1550	0.0000	0.0016	0.0048	0.0061
32	1600	0.0000	0.0002	0.0045	
33	1650	0.0000	0.0016	0.0043	0.0058
34	1700	0.0000	0.0002	0.0040	
35	1750	0.0000	0.0011	0.0045	0.0054
36	1800	0.0000	0.0002	0.0040	
37	1850	0.0000	0.0009	0.0042	0.0051
38	1900	0.0000	0.0002	0.0038	
39	1950	0.0000	0.0012	0.0035	0.0049
40	2000	0.0000	0.0002	0.0036	

EUT is PASSED if:

- all Average values of the Individual Harmonic Currents (Iavg) are below 100% of the Individual Limits.
- all Maximum values of the Individual Harmonic Currents (I_{max}) are below 150% of the Individual Limits.

Test engineer: Sun. Zhang



6.4. Test Photographs





7. Voltage Fluctuations Test

7.1. Test Procedure

The equipment shall be tested under the conditions of **Clause 5**.

The total impedance of the test circuit, excluding the appliance under test, but including the internal impedance of the supply source, shall be equal to the reference impedance. The stability and tolerance of the reference impedance shall be adequate to ensure that the overall accuracy of $\pm 8\%$ is achieved during the whole assessment procedure.

7.2. Measurement equipment

Instrument/Ancillary	Manufacturer	Model No.	Serial No.	Calibration Date	Valid Date.
EMC Emission Tester	EMCPARTNER	Harmonics-1000	159	2017.07.12	2018.07.11
Temperature/ Humidity Meter	Zhicheng	ZC1-11	CEP-TH-004	2017.03.28	2018.03.27
HARCS	EMC Partner AG	Ver 4.18	N/A	N/A	N/A



7.3. Test Result and Data

Basic Standard	:	EN 61000-3-3
Final Test Result	:	PASS
Test Mode	:	Mode 1,2,3,4
Model No.	:	*2590*****
Temperature	:	22°C
Humidity	:	53 %
Atmospheric Pressure	:	100 kPa
Test Date	:	Oct 22, 2017

Flicker Emission IEC 61000-4-15 for 230V/50Hz

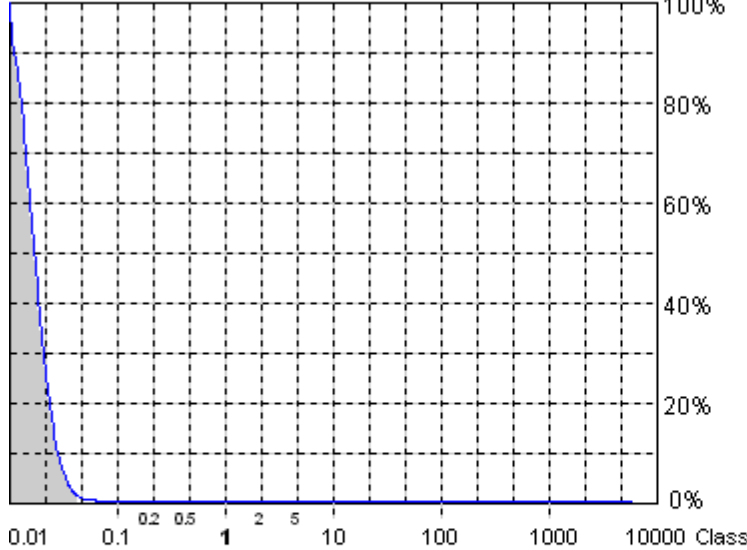

Actual Flicker (Fli): 0.02
Short-term Flicker (Pst): 0.13
 Limit (Pst): 1.00
Long-term Flicker (Plt): 0.13
 Limit (Plt): 0.65
Maximum Relative Volt. Change (dmax): 0.01%
 Limit (dmax): 4.00%
Relative Steady-state Voltage Change (dc): 0.14%
 Limit (dc): 3.00%
Tmax 3.00% (dt): 0.00ms
 Limit (dt>Lim): 500ms

Flicker Emission - IEC 61000-3-3, EN 61000-3-3

Urms = 230.1 V P = 33.72 W
 Irms = 0.183 A pf = 0.802

2017-10-22 14:36:28 harmonic.hsu

Range: 1 A
 V-nom: 230 V
 TestTime: 10 min (100%)

Test completed, Result: PASSED

HAR-1000 EMC-Partner

- Full Bar : Actual Values
- Empty Bar : Maximum Values
- Circles : Average Values
- Blue : Current , Green : Voltage , Red : Failed



Urms = 230.1V Freq = 50.000 Range: 1 A
Irms = 0.183A Ipk = 0.311A cf = 1.703
P = 33.72W S = 42.02VA pf = 0.802

Test - Time : 1 x 10min = 10min (100 %)

LIN (Line Impedance Network) : No LIN

Limits : Plt : 0.65 Pst : 1.00
dmax : 4.00 % dc : 3.00 %
dtLim: 3.00 % dt>Lim: 500ms

Test completed, Result: PASSED

Test engineer: Sun. Zhang



7.4. Test Photographs





8. Electrostatic Discharge Immunity Test

8.1. Test Procedure

- a. In the case of air discharge testing the climatic conditions shall be within the following ranges:
 - ambient temperature: 15°C to 35°C;
 - relative humidity : 30% to 60%;
 - atmospheric pressure : 86 KPa (860 hPa) to 106 KPa (1060 hPa).
- b. Test programs and software shall be chosen so as to exercise all normal modes of operation of the EUT. The use of special exercising software is encouraged, but permitted only where it can be shown that the EUT is being comprehensively exercised.
- c. The test voltage shall be increased from the minimum to the selected test severity level, in order to determine any threshold of failure. The final severity level should not exceed the product specification value in order to avoid damage to the equipment.
- d. The test shall be performed with both air discharge and contact discharge. On reselected points at least 10 single discharges (in the most sensitive polarity) shall be applied on air discharge. On reselected points at least 25 single discharges (in the most sensitive polarity) shall be applied on contact discharge.
- e. For the time interval between successive single discharges an initial value of one second is recommended. Longer intervals may be necessary to determine whether a system failure has occurred.
- f. In the case of contact discharges, the tip of the discharge electrode shall touch the EUT before the discharge switch is operated.
- g. In the case of painted surface covering a conducting substrate, the following procedure shall be adopted :
 - ✧ If the coating is not declared to be an insulating coating by the equipment manufacturer, then the pointed tip of the generator shall penetrate the coating so as to make contact with the conducting substrate.
 - ✧ Coating declared as insulating by the manufacturer shall only be submitted to the air discharge.
 - ✧ The contact discharge test shall not be applied to such surfaces.
- h. In the case of air discharges, the round discharge tip of the discharge electrode shall be approached as fast as possible (without causing mechanical damage) to touch the EUT . After each discharge, the ESD generator (discharge electrode) shall be removed from the EUT. The generator is then retriggered for a new single discharge. This procedure shall be repeated until the discharges are completed. In the case of an air discharge test, the discharge switch, which is used for contact discharge, shall be closed.

8.2. Test Setup for Tests Performed in Laboratory

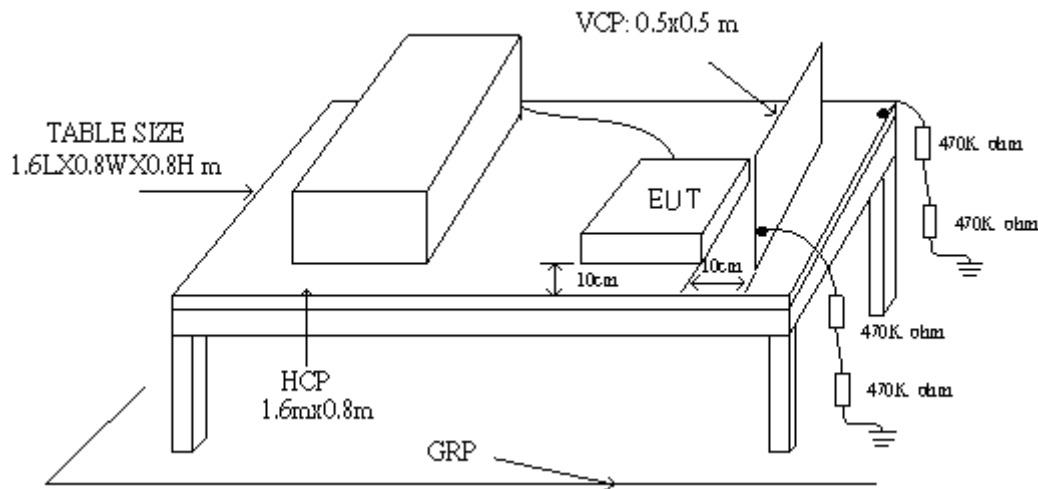

The test setup consists of the test generator, EUT and auxiliary instrumentation necessary to perform DIRECT and INDIRECT application of discharges to the EUT as applicable, in the following manner :

- a. Contact Discharge to the conductive surfaces and to coupling plane;
- b. Air Discharge at insulating surfaces.

The preferred test method is that of type tests performed in laboratories and the only accepted method of demonstrating conformance with this standard. The EUT was arranged as closely as possible to arrangement in final installed conditions.

A ground reference plane was provided on the floor of the test site. It was a metallic sheet (copper or aluminum) of 0.25 mm, minimum thickness; other metallic may be used but they shall have at least 0.65 mm thickness. In the Exclusive Certification Corp., we provided 1 mm thickness stainless steel ground reference plane. The minimum size of the ground reference plane is 2.5 m x 2.5 m, the exact size depending on the dimensions of the EUT. It was connected to the protective grounding system.

The EUT was arranged and connected according to its functional requirements. A distance of 1m minimum was provided between the EUT and the wall of the lab. and any other metallic structure. In cases where this length exceeds the length necessary to apply the discharges to the selected points, the excess length shall, where possible, be placed non-inductively off the ground reference plane and shall not come closer than 0.2m to other conductive parts in the test setup.

Where the EUT is installed on a metal table, the table was connected to the reference plane via a cable with a 470k ohm resistor located at each end, to prevent a build-up of charge. The test setup was consist a wooden table, 0.8m high, standing on the ground reference plane. A HCP, 1.6 m x



0.8 m, was placed on the table. The EUT and cables was isolated from the HCP by an insulating support 0.5 mm thick. The VCP size, 0.5 m x 0.5 m.

8.3. Test Severity Levels

Contact Discharge		Air Discharge	
Level	Test Voltage (kV) of Contact discharge	Level	Test Voltage (kV) of Air Discharge
1	±2	1	±2
2	±4	2	±4
3	±6	3	±8
4	±8	4	±15
X	Specified	X	Specified

Remark: "X" is an open level.

8.4. Measurement equipment

Instrument/Ancillary	Manufacturer	Model No.	Serial No.	Calibration Date	Valid Date.
ESD Simulator	NoiseKen	ESS-B3011A	AEC00315-00 C-0A	2016.12.12	2017.12.11
Tonometer	shanghaifengyun	DYM3	3251	2016.12.21	2017.12.20
Dehumidifier	ZEDO	ZD-220LB	CEP-TH-01	N/A	N/A
Humidifier	YADU	YZ-DS251C	CEP-TH-02	N/A	N/A
Temperature/ Humidity Meter	feiyun	N/A	102	2017.03.28	2018.03.27



8.5. Test Result and Data

Basic Standard : IEC 61000-4-2
 Final Test Result : PASS
 Model No. : *2590*****
 Test Voltage : ±2 / ±4 / ±8 kV for air discharge,
 : ±2 / ±4 kV for contact discharge
 Temperature : 24 °C
 Relative Humidity : 47 %
 Atmospheric Pressure : 100 kPa
 Test Date : Oct 23, 2017

Test mode 1,2,3,4

	Contact Discharge								Air Discharge							
	25 times / each								10 times / each							
Voltage	2 kV		4 kV		6 kV		8 kV		2 kV		4 kV		8 kV		10 kV	
Point\Polarity	+	-	+	-	+	-	+	-	+	-	+	-	+	-	+	-
HCP	A	A	A	A	---	---	---	---	---	---	---	---	---	---	---	---
VCP	A	A	A	A	---	---	---	---	---	---	---	---	---	---	---	---
Screw	A	A	A	A	---	---	---	---	---	---	---	---	---	---	---	---
Case	---	---	---	---	---	---	---	---	A	A	A	A	A	A	---	---
Panel	---	---	---	---	---	---	---	---	A	A	A	A	A	A	---	---
VGA Port	A	A	A	A	---	---	---	---	---	---	---	---	---	---	---	---
HDMI 1 Port	A	A	A	A	---	---	---	---	---	---	---	---	---	---	---	---
HDMI 2 Port	A	A	A	A	---	---	---	---	---	---	---	---	---	---	---	---
DP Port	A	A	A	A	---	---	---	---	---	---	---	---	---	---	---	---
USB Port	A	A	A	A	---	---	---	---	---	---	---	---	---	---	---	---
Audio Port	---	---	---	---	---	---	---	---	A	A	A	A	A	A	---	---
Power Port	---	---	---	---	---	---	---	---	A	A	A	A	A	A	---	---
Button	---	---	---	---	---	---	---	---	A	A	A	A	A	A	---	---
LED Light	---	---	---	---	---	---	---	---	A	A	A	A	A	A	---	---

Test engineer: Sun. Zhang



8.6. Test Photographs





9. Radio Frequency electromagnetic field immunity test

9.1. Test Procedure

- i. The equipment to be tested is placed in the center of the enclosure on a wooden table. The equipment is then connected to power and signal leads according to pertinent installation instructions.
- j. The antenna which is enabling the complete frequency range of 80-1000 MHz is placed 3m away from the equipment. The required field strength is determined by placing the field strength meter(s) on top of or directly alongside the equipment under test and monitoring the field strength meter via a remote field strength indicator outside the enclosure while adjusting the continuous-wave to the applicable antennae.
- k. The test is normally performed with the antenna facing the most sensitive side of the EUT. The polarization of the field generated by the bucolical antenna necessitates testing each position twice, once with the antenna positioned vertically and again with the antenna positioned horizontally. The circular polarization of the field from the log-spiral antenna makes a change of position of the antenna unnecessary.
- l. At each of the above conditions, the frequency range is swept 80-1000 MHz, pausing to adjust the R.F. signal level or to switch oscillators and antenna. The rate of sweep is in the order of 1.5×10^{-3} decades/s. The sensitive frequencies or frequencies of dominant interest may be discretely analyzed.



9.2. Test Severity Levels

Frequency Band	
Level	Test field strength (V/m)
1	1
2	3
3	10
X	Specified
Remark: "X" is an open class.	

9.3. Measurement equipment

Instrument/Ancillary	Manufacturer	Model No.	Serial No.	Calibration Date	Valid Date.
Signal Generator	R&S	SML03	103287	2017.03.22	2018.03.21
Power Sensor	R&S	NR P-Z91	100383	2017.03.22	2018.03.21
Power Meter	R&S	NRP	101206	2017.03.22	2018.03.21
Power Amplifier	BONN	BLWA0830-16 0/100/40D	076659	2017.03.22	2018.03.21
Istropic Electric Field Probe	EST.LINDGRE N	HI-6105	137445	2016.11.20	2017.11.19
EMS Antenna	R&S	HL046E	100028	N/A	N/A
Temperature/ Humidity Meter	feiyang	N/A	101	2017.03.28	2018.03.27
EMC-32	Rohde&Schwa rz	Ver 6.10.0	N/A	N/A	N/A



9.4. Test Result and Data

Basic Standard : IEC 61000-4-3
 Final Test Result : PASS
 Model No. : *2590*****
 Frequency Range : 80~1000 MHz
 Temperature : 23 °C
 Relative Humidity : 52%
 Atmospheric Pressure : 100 kPa
 Test Date : Oct 23, 2017

Test mode 1,2,3,4

Modulation : AM 80% , 1KHz sine wave , Dwell time: 3.0 S				
Frequency Step Size : 1 % of preceding frequency value				
Frequency (MHz)	Antenna Polarization	face	Field strength (V/m)	Result
80~1000	Vertical	Front	3 V/m	A
80~1000	Vertical	Rear	3 V/m	A
80~1000	Vertical	Left	3 V/m	A
80~1000	Vertical	Right	3 V/m	A
80~1000	Horizontal	Front	3 V/m	A
80~1000	Horizontal	Rear	3 V/m	A
80~1000	Horizontal	Left	3 V/m	A
80~1000	Horizontal	Right	3 V/m	A

Test engineer: Sun. Zhang



9.5. Test Photographs





10. Electrical Fast Transient/ Burst Immunity Test

10.1. Test Procedure

- a. In order to minimize the effect of environmental parameters on test results, the climatic conditions when test is carrying out shall comply with the following requirements:
 - ✧ ambient temperature: 15°C to 35°C;
 - ✧ relative humidity : 45% to 75%;
 - ✧ Atmospheric pressure: 86 Kpa (860 hPa) to 106 Kpa (1060 hPa).
- b. In order to minimize the effect of environmental parameters on test results, the electromagnetic environment of the laboratory shall not influence the test results.
- c. The variety and diversity of equipment and systems to be tested make it difficult to establish general criteria for the evaluation of the effects of fast transients/bursts on equipment and systems.
- d. Test on Power Line:
 - ✧ The EFT/B-generator was located on the GRP.. The length from the EFT/B-generator to the EUT is not exceeding 1 m.
 - ✧ The EFT/B-generator provides the ability to apply the test voltage in a non-symmetrical condition to the power supply input terminals of the EUT.
- e. Test on Communication Lines
 - ✧ The coupling clamp is composed of a clamp unit for housing the cable (length more than 3 m), and was placed on the GRP.
 - ✧ The coupling clamp provides the ability of coupling the fast transient/bursts to the cable under test.
- f. The test results may be classified on the basic of the operating conditions and the functional specification of the equipment under test, according to the following performance criteria :
 - ✧ Normal performance within the specification limits.
 - ✧ Temporary degradation or loss of function or performance which is self-recoverable.
 - ✧ Temporary degradation or loss of function or performance which requires operator intervention or system reset.
 - ✧ Degradation or loss of function which is not recoverable due to damage of equipment (components).



10.2. Test Severity Levels

The following test severity levels are recommended for the fast transient/burst test :

Open circuit output test voltage $\pm 10\%$		
Level	On Power Supply	On I/O signal, data and control line
1	0.5 kV	0.25 kV
2	1.0 kV	0.50 kV
3	2.0 kV	1.00 kV
4	4.0 kV	2.00 kV
X	Specified	Specified

Remark : " X " is an open level. The level is subject to negotiation between the user and the manufacturer or is specified by the manufacturer.

10.3. Measurement equipment

Instrument/Ancillary	Manufacturer	Model No.	Serial No.	Calibration Date	Valid Date.
TRANSIENT	EMCPARTNER	TRA2000IN6	901	2017.06.21	2018.06.20
CDN	EMCPARTNER	CDN2000-06-32	121	2017.03.22	2018.03.21
Coupling clamp	EMCPARTNER	CN-EFT1000	547	2017.03.22	2018.03.21
Temperature/ Humidity Meter	Zhicheng	ZC1-11	CEP-TH-005	2017.03.28	2018.03.27



10.4. Test Result and Data

Basic Standard : IEC 61000-4-4
 Final Test Result : PASS
 Model No. : *2590*****
 Test Voltage : On Power Supply -- ±1.0 kV
 : On I/O signal, data and control line -- ±0.5 kV
 Temperature : 24°C
 Relative Humidity : 50%
 Atmospheric Pressure : 100 kPa
 Test Date : Oct 23,2017

Test mode 1,2,3,4

Pulse : 5/50 ns		Repetition Rate: <u>5 kHz</u>			
Burst : 15m/300ms					
Test time : 1 min/each condition					
Voltage/ Mode/ Polarity/ Result/ Phase		<u>0.5 kV</u>		<u>1.0 kV</u>	
		+	-	+	-
Power Line	L	---	---	A	A
	N	---	---	A	A
	L-N	---	---	A	A
	PE	---	---	A	A
	L-PE	---	---	A	A
	N-PE	---	---	A	A
	L-N-PE	---	---	A	A

Test engineer: Sun. Zhang



10.5. Test Photographs





11. Surge Immunity Test

11.1. Test Procedure

a. Climatic conditions

The climatic conditions shall comply with the following requirements :

- ✧ ambient temperature : 15 °C to 35 °C
- ✧ relative humidity : 10 % to 75 %
- ✧ atmospheric pressure : 86 kPa to 106 kPa (860 hPa to 1060 hPa)

b. Electromagnetic conditions

the electromagnetic environment of the laboratory shall not influence the test results.

c. The test shall be performed according the test plan that shall specify the test set-up with

- ✧ generator and other equipment utilized;
- ✧ test level (voltage/current);
- ✧ generator source impedance;
- ✧ internal or external generator trigger;
- ✧ number of tests : at least five positive and five negative at the selected points;
- ✧ repetition rate : maximum 1/min.
- ✧ inputs and outputs to be tested;
- ✧ representative operating conditions of the EUT;
- ✧ sequence of application of the surge to the circuit;
- ✧ phase angle in the case of AC. power supply;
- ✧ actual installation conditions, for example :

AC : neutral earthed,

DC : (+) or (-) earthed to simulated the actual earthing conditions.

- d. If not otherwise specified the surges have to be applied synchronized to the voltage phase at the zero-crossing and the peak value of the AC. voltage wave (positive and negative).
- e. The surges have to be applied line to line and line(s) and earth. When testing line to earth, the test voltage has to be applied successively between each of the lines and earth, if there is no other specification.
- f. The test procedure shall also consider the non-linear current-voltage characteristics of the equipment under test. Therefore the test voltage has to be increased by steps up to the test level specified in the product standard or test plan.
- g. All lower levels including the selected test level shall be satisfied. For testing the secondary protection, the output voltage of the generator shall be increased up to the worst-case voltage breakdown level (let-through level) of the primary protection.
- h. If the actual operating signal sources are not available, that may be simulated. Under no circumstances may the test level exceed the product specification. The test shall be carried out according to a test plan.
- i. To find all critical points of the duty cycle of the equipment, a sufficient number of positive and negative test pulses shall be applied. For acceptance test previously unstressed equipment shall be used to the protection devices shall be replaced.



11.2. Test Severity Level

Level	Open-circuit test voltage, $\pm 10\%$, kV
1	0.5
2	1.0
3	2.0
4	4.0
X	Specified

NOTE: "X" is an open class. This level can be specified in the product specification.

11.3. Measurement equipment

Instrument/Ancillary	Manufacturer	Model No.	Serial No.	Calibration Date	Valid Date.
TRANSIENT	TESEQ	NSG 3060	1830	2017.02.22	2018.02.21
CDN	TESEQ	CDN 3061	1575	2017.02.22	2018.02.21
CDN	TESEQ	CNV508T5	P 1546167499	2017.02.22	2018.02.21
CDN	TESEQ	CDN HSS-2	41020	2017.02.22	2018.02.21
Temperature/ Humidity Meter	Zhicheng	ZC1-11	CEP-TH-005	2017.03.28	2018.03.27



11.5. Test Photographs





12. Conduction Disturbances induced by Radio-Frequency Fields

12.1. Test Procedure

- a. The EUT shall be operated within its intended climatic conditions. The temperature and relative humidity should be recorded.
- b. This test method test can be performed without using a sell shielded enclosure. This is because the disturbance levels applied and the geometry of the setups are not likely to radiated a high amount of energy, especially at the lower frequencies. If under certain circumstances the radiated energy is too high, a shielded enclosure has to be used.
- c. The test shall be performed with the test generator connected to each of the coupling and decoupling devices in turn while the other non-excited RF-input ports of the coupling devices are terminated by a 50 ohm load resistor.
- d. The frequency range is swept from 150 KHz to 80 MHz, using the signal levels established during the setting process, and with the disturbance signal 80% amplitude modulated with a 1KHz sign wave, pausing to adjust the RF-signal level or to switch coupling devices as necessary. The rate of sweep shall no exceed 1.5×10^{-3} decades/s. Where the frequency is swept incrementally, the step size shall no exceed 1% of the start and thereafter 1% of the preceding frequency value.
- e. The dwell time at each frequency shall not be less than the time necessary for the EUT to be exercised, and able to respond. Sensitive frequencies e.g. clock frequency (ies) and harmonics or frequencies of dominant interest shall be analyzed separately.
- f. An alternative test procedure may be adopted, wherein the frequency range is swept incrementally, with a step size not exceeding 4% of the start ad thereafter 4% of the preceding frequency value. The test level should be at least twice the value of the specified test level.
- g. In cases of dispute, the test procedure using a step size not exceeding 1% of the start and thereafter 1% of preceding frequency value shall take precedence.
- h. Attempts should be made to fully exercise the EUT during testing, and to fully interrogate all exercise modes selected for susceptibility.
- i. The use of special exercising programs is recommended.
- j. Testing shall be performed according to a Test Plan, which shall be included in the test report.
- k. It may be necessary to carry out some investigatory testing in order to establish some aspects of the test plan.



12.2. Test Severity Levels

Level	Voltage Level (e.m.f.)
1	1 V
2	3 V
3	10 V
x	Specified

NOTE - x is an open class. This level can be specified in the product specification.

12.3. Measurement equipment

Instrument/Ancillary	Manufacturer	Model No.	Serial No.	Calibration Date	Valid Date.
Conducted immunity test system	FRANKONIA	CIT-10/75	102D1294	2017.03.22	2018.03.21
EM Injection clamp	FCC	F-203I-23MM	536	2017.03.22	2018.03.21
CDN	FRANKONIA	CDN-M2+M3	A3011102	2017.03.22	2018.03.21
CDN	FCC	CDN-M5/32	A3013024	2017.03.22	2018.03.21
CDN	TESEQ	CDN T8-10	43767	2017.08.26	2018.08.25
CDN	TESEQ	CDN T2-10	43762	2017.08.26	2018.08.25
CDN	TESEQ	CDN T4-10	43754	2017.08.26	2018.08.25
CDN	TESEQ	CDN M016	44025	2017.08.26	2018.08.25
6 dB Attenuator	FRANKONIA	N/A	N/A	2017.03.22	2018.03.21
Temperature/ Humidity Meter	Zhicheng	ZC1-11	CEP-TH-005	2017.03.28	2018.03.27
EN61000-4-6	Hubert GmbH	Ver 2.21	N/A	N/A	N/A



12.4. Test Result and Data

Basic Standard : IEC 61000-4-6
Final Test Result : PASS
Model No. : *2590*****
Coupling mode : CDN-(M2+M3) for AC power ports
Temperature : 24°C
Relative Humidity : 50%
Atmospheric Pressure : 100 kPa
Test Date : Oct 23,2017

Test mode 1,2,3,4

Frequency : 0.15~80MHz, Modulation : AM 80%,1KHz sine wave, Dwell time: 3.0s Frequency Step Size : 1 % of preceding frequency value			
Frequency	Test mode	Voltage(V)	Result
0.15 ~ 80MHz	Power(M3)	3	A

Test engineer: Sun. Zhang



12.5. Test Photographs



13. Power Frequency Magnetic Field Immunity Tests

13.1. Test Setup

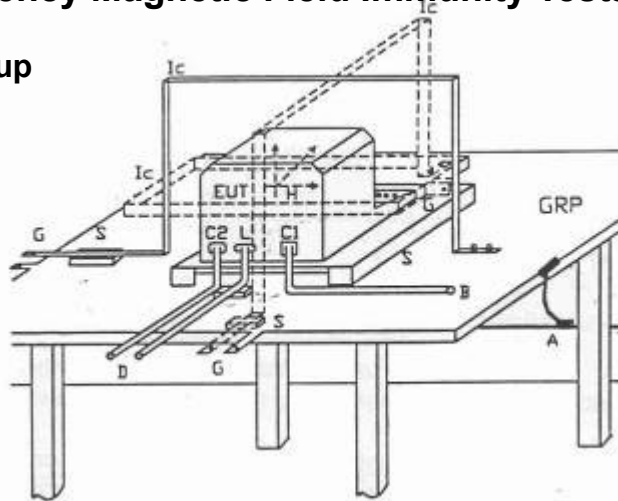

GPR	: Ground plane	C1	: Power supply circuit
A	: Safety earth	C2	: Signal circuit
S	: Insulating support	L	: Communication line
EUT	: Equipment under test	B	: To power supply source
Lc	: Induction coil	D	: To signal source, simulator
E	: Earth terminal	G	: To the test generator

13.2. Test Severity Levels

Level	Magnetic field strength A/m
1	1
2	3
3	10
4	30
5	100
X ¹⁾	special

NOTE 1 "X" is an open level. This level can be given in the product specification.

13.3. Measurement equipment

Instrument/Ancillary	Manufacturer	Model No.	Serial No.	Calibration Date	Valid Date.
TRANSIENT	EMCPARTNER	TRA2000IN6	901	2017.06.21	2018.06.20
H-Filed-Loop	EMCPARTNER	MF1000-1	144	2017.03.22	2018.03.21
Temperature/ Humidity Meter	Zhicheng	ZC1-11	CEP-TH-005	2017.03.28	2018.03.27



13.4. Test Result and Data

Basic Standard : IEC 61000-4-8
 Final Test Result : PASS
 Model No. : *2590*****
 Temperature : 24°C
 Relative Humidity : 50%
 Atmospheric Pressure : 100 kPa
 Test Date : Oct 23,2017

Test mode 1,2,3,4

Power Frequency Magnetic Field : 50 Hz, 1 A/m		
Coil Orientation	Testing duration	Results
X-axis	1.0 Min	A
Y-axis	1.0 Min	A
Z-axis	1.0 Min	A
Power Frequency Magnetic Field : 60 Hz, 1 A/m		
Coil Orientation	Testing duration	Results
X-axis	1.0 Min	A
Y-axis	1.0 Min	A
Z-axis	1.0 Min	A

Test engineer: Sun. Zhang



13.5. Test Photographs





14. Voltage Dips and Voltage Interruptions Immunity Test Setup

14.1. Test Conditions

1. Source voltage and frequency : 230V / 50Hz, Single phase.
2. Test of interval : 10 sec.
3. Level and duration : Sequence of 3 dips/interrupts.
4. Voltage rise (and fall) time : 1 ~ 5 μ s.
5. Test severity :

Voltage dips and Interrupt reduction (%)	Test Duration (period)
>95%	250
30%	25
>95%	0.5

14.2. Measurement equipment

Instrument/Ancillary	Manufacturer	Model No.	Serial No.	Calibration Date	Valid Date.
TRANSIENT	EMCPARTNER	TRA2000IN6	901	2017.06.21	2018.06.20
Temperature/ Humidity Meter	Zhicheng	ZC1-11	CEP-TH-005	2017.03.28	2018.03.27



14.3. Test Result and Data

Basic Standard : IEC 61000-4-11
 Final Test Result : PASS
 Model No. : *2590*****
 Pass performance Criteria : C for voltage interruption, B for voltage dips
 Temperature : 24°C
 Relative Humidity : 50%
 Atmospheric Pressure : 100 kPa
 Test Date : Oct 23,2017

Test mode 1,2,3,4										
Voltage(UT): AC 230/240 V/ 50 Hz Interval(s) : 10s Times : 3										
Test mod	Test level UT %	Durations (period / ms)	Phase / Result							
			0	45	90	135	180	225	270	315
Voltage interruptions	>95%	250	C	C	C	C	C	C	C	C
Voltage dips	30%	25	B	B	B	B	B	B	B	B
	>95%	0.5	B	B	B	B	B	B	B	B

Test mode 1,2,3,4										
Voltage(UT): AC 100 V/ 50 Hz Interval(s) : 10s Times : 3										
Test mod	Test level UT %	Durations (period / ms)	Phase / Result							
			0	45	90	135	180	225	270	315
Voltage interruptions	>95%	250	C	C	C	C	C	C	C	C
Voltage dips	30%	25	B	B	B	B	B	B	B	B
	>95%	0.5	B	B	B	B	B	B	B	B

Test engineer: Sun. Zhang



14.4. Test Photographs





15. Photographs of EUT

1) EUT Photo



2) EUT Photo

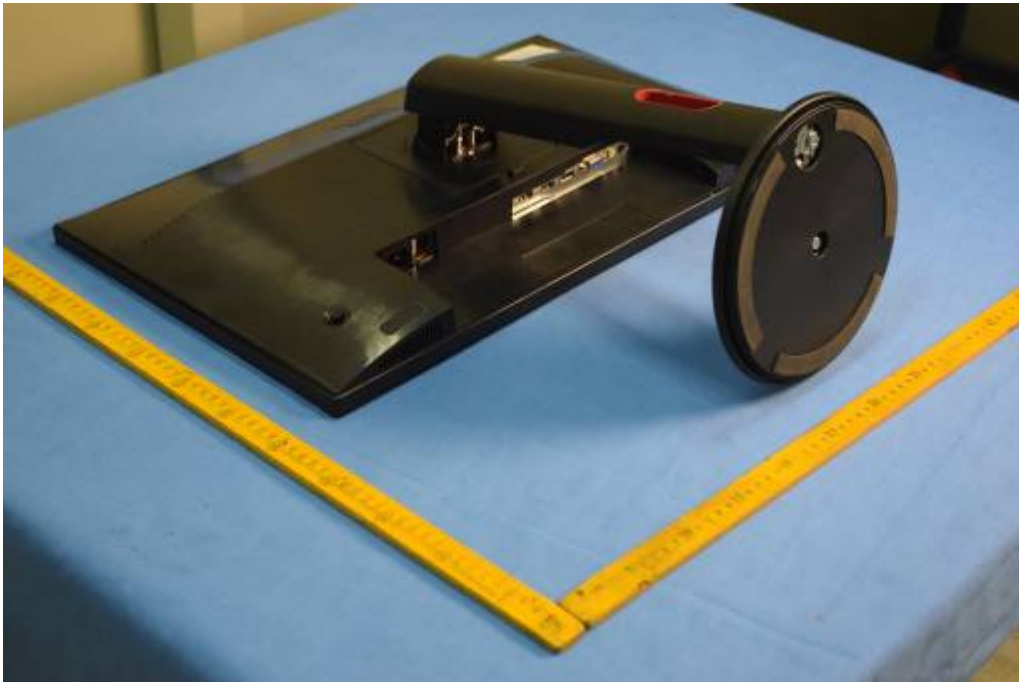



3) EUT Photo



4) EUT Photo





5) EUT Photo



6) EUT Photo

