

AOC

LCD Monitor User Manual

AG273QCX LED backlight



HDMI[®]

www.aoc.com

©2018 AOC. All Rights Reserved.

Safety	1
National Conventions	1
Power	2
Installation	3
Cleaning	4
Other	5
Setup	6
Contents in Box	6
Setup Stand & Base	7
Adjusting the monitor	8
Connecting the Monitor	9
FreeSync2 function	10
Freesync2	11
HDR	12
Hotkeys	13
Quick Switch	14
OSD Key Guide (Menu)	15
OSD Setting	17
Game Setting	18
Luminance	19
Image Setup	20
Color Setup	21
Audio	22
Light FX	23
Extra	24
OSD Setup	25
LED Indicator	26
Troubleshoot	27
Specification	28
General Specification	28
Preset Display Modes	29
Pin Assignments	30
Plug and Play	32
G-Menu	33
e-Saver	34
Screen+	35

Safety

National Conventions

The following subsections describe notational conventions used in this document.

Notes, Cautions, and Warnings

Throughout this guide, blocks of text may be accompanied by an icon and printed in bold type or in italic type. These blocks are notes, cautions, and warnings, and they are used as follows:



NOTE: A NOTE indicates important information that helps you make better use of your computer system.



CAUTION: A CAUTION indicates either potential damage to hardware or loss of data and tells you how to avoid the problem.



WARNING: A WARNING indicates the potential for bodily harm and tells you how to avoid the problem. Some warnings may appear in alternate formats and may be unaccompanied by an icon. In such cases, the specific presentation of the warning is mandated by regulatory authority.

Power

 The monitor should be operated only from the type of power source indicated on the label. If you are not sure of the type of power supplied to your home, consult your dealer or local power company.

 The monitor is equipped with a three-pronged grounded plug, a plug with a third (grounding) pin. This plug will fit only into a grounded power outlet as a safety feature. If your outlet does not accommodate the three-wire plug, have an electrician install the correct outlet, or use an adapter to ground the appliance safely. Do not defeat the safety purpose of the grounded plug.

 Unplug the unit during a lightning storm or when it will not be used for long periods of time. This will protect the monitor from damage due to power surges.

 Do not overload power strips and extension cords. Overloading can result in fire or electric shock.

 To ensure satisfactory operation, use the monitor only with UL listed computers which have appropriate configured receptacles marked between 100-240V AC, Min. 5A.

 The wall socket shall be installed near the equipment and shall be easily accessible.

Installation

! Do not place the monitor on an unstable cart, stand, tripod, bracket, or table. If the monitor falls, it can injure a person and cause serious damage to this product. Use only a cart, stand, tripod, bracket, or table recommended by the manufacturer or sold with this product. Follow the manufacturer's instructions when installing the product and use mounting accessories recommended by the manufacturer. A product and cart combination should be moved with care.

! Never push any object into the slot on the monitor cabinet. It could damage circuit parts causing a fire or electric shock. Never spill liquids on the monitor.

! Do not place the front of the product on the floor.

! If you mount the monitor on a wall or shelf, use a mounting kit approved by the manufacturer and follow the kit instructions.

! Leave some space around the monitor as shown below. Otherwise, air-circulation may be inadequate hence overheating may cause a fire or damage to the monitor.

See below the recommended ventilation areas around the monitor when the monitor is installed on the wall or on the stand:

Installed with stand

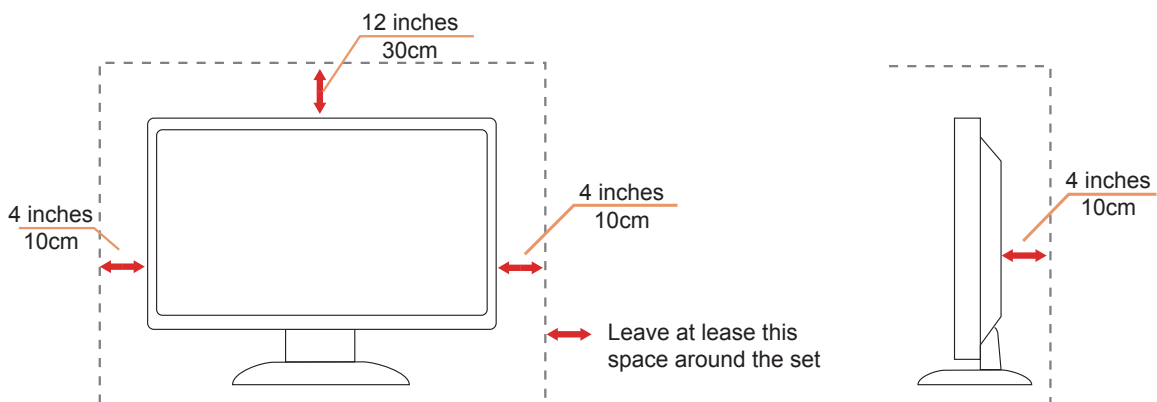

Cleaning

⚠ Clean the cabinet regularly with cloth. You can use soft-detergent to wipe out the stain, instead of strong-detergent which will cauterize the product cabinet.

⚠ When cleaning, make sure no detergent is leaked into the product. The cleaning cloth should not be too rough as it will scratch the screen surface.

⚠ Please disconnect the power cord before cleaning the product.



Other

 If the product is emitting a strange smell, sound or smoke, disconnect the power plug IMMEDIATELY and contact a Service Center.

 Make sure that the ventilating openings are not blocked by a table or curtain.

 Do not engage the LCD monitor in severe vibration or high impact conditions during operation.

 Do not knock or drop the monitor during operation or transportation.

Setup

Contents in Box

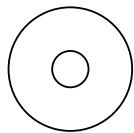
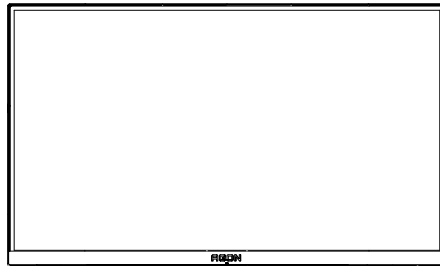

CD Manual

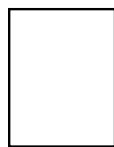

Warranty card

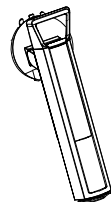

Stand



Screws

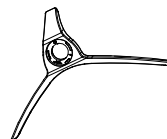

Base



Hand Screw



Wire clip



Quick Switch Keypad



Power Cable



D-SUB Cable



DP Cable



HDMI Cable



USB Cable



Micphone Cable

★ Not all signal cables (D-SUB, DP, HDMI, USB and Micphone cables) will be provided for all countries and regions. Please check with the local dealer or AOC branch office for confirmation.

Setup Stand & Base

Please setup or remove the base following the steps as below.

Setup:

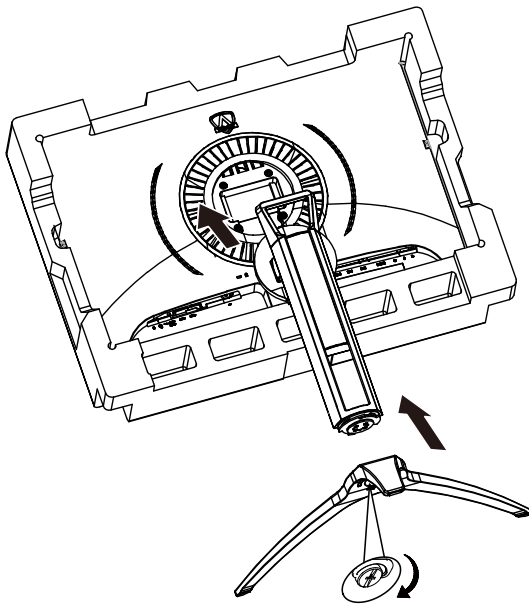

Remove:

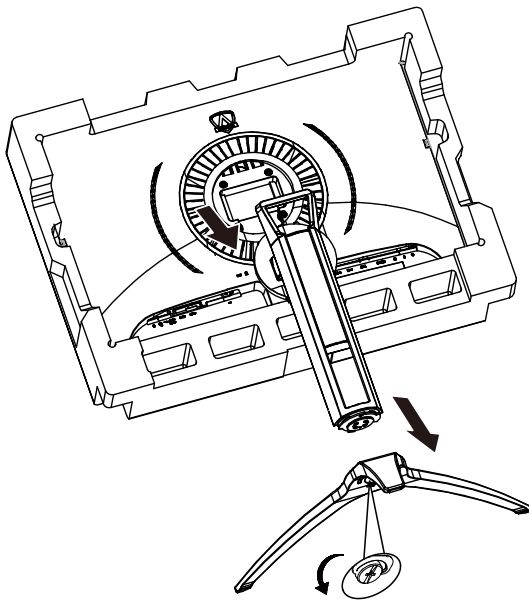

Adjusting the monitor

For optimal viewing it is recommended to look at the full face of the monitor, then adjust the monitor's angle to your own preference.

Hold the stand so you will not topple the monitor when you change the monitor's angle.

You are able to adjust the monitor as below:

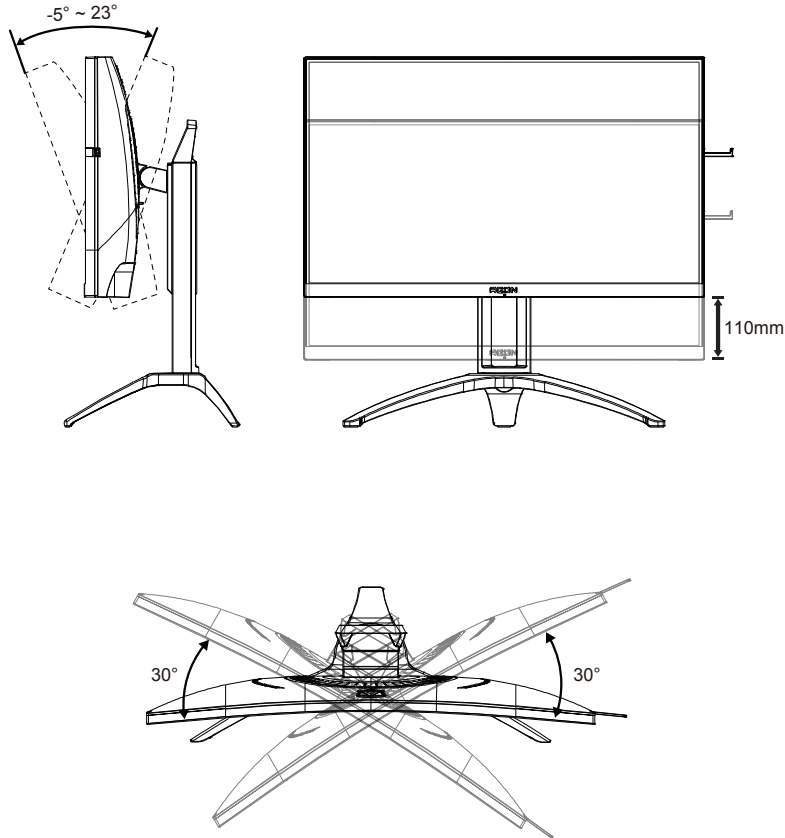

 **NOTE:**

Do not touch the LCD screen when you change the angle. It may cause damage or break the LCD screen.

Connecting the Monitor

Cable Connections In Back of Monitor and Computer:

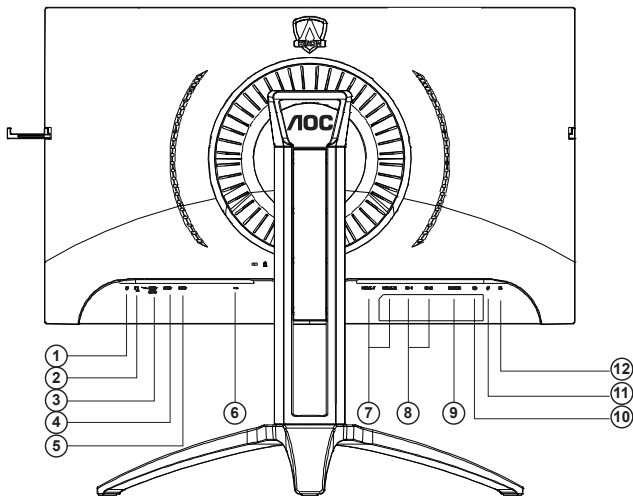

1. Microphone in
2. Earphone (Combined with Microphone)
3. USB3.1 Gen1 downstream + fast charging(BC1.2)
4. USB3.1 Gen1 downstream
5. USB3.1 Gen1 upstream
6. AC in
7. HDMI
8. DP
9. D-SUB
10. Audio in
11. Microphone out (Connect to PC)
12. Quick Switch port

To protect equipment, always turn off the PC and LCD monitor before connecting.

1. Connect the power cable to the AC port on the back of the monitor.
2. Connect one end of the 15-pin D-Sub cable to the back of the monitor and connect the other end to the computer's D-Sub port.
3. (Optional – Requires a video card with HDMI port) - Connect one end of the HDMI cable to the back of the monitor and connect the other end to the computer's HDMI port.
4. (Optional–Requires a video card with DP port) –Connect one end of the DP cable to the back of the monitor and connect the other end to the computer's DP port.
5. (Optional –Requires a video card with Audio port) - Connect one end of the Audio cable to the back of the monitor and connect the other end to the computer's Audio port.
6. Turn on your monitor and computer.

If your monitor displays an image, installation is complete. If it does not display an image, please refer Troubleshooting.

FreeSync2 function

1. FreeSync2 function is working with DP/HDMI
2. Compatible Graphics Card: Recommend list is as the below, also could be checked by visiting www.AMD.com

- Graphics Cards
- Radeon™ RX Vega series
- Radeon™ RX 500 series
- Radeon™ RX 400 series
- Radeon™ R9/R7 300 series (excluding R9 370/X)
- Radeon™ Pro Duo (2016 edition)
- Radeon™ R9 Nano
- Radeon™ R9 Fury series
- Radeon™ R9/R7 200 series (excluding R9 270/X, R9 280/X)

- Processors
- AMD Ryzen™ 7 2700U
- AMD Ryzen™ 5 2500U
- AMD Ryzen™ 5 2400G
- AMD Ryzen™ 3 2300U
- AMD Ryzen™ 3 2200G
- AMD PRO A12-9800
- AMD PRO A12-9800E
- AMD PRO A10-9700
- AMD PRO A10-9700E
- AMD PRO A8-9600
- AMD PRO A6-9500
- AMD PRO A6-9500E
- AMD PRO A12-8870
- AMD PRO A12-8870E
- AMD PRO A10-8770
- AMD PRO A10-8770E
- AMD PRO A10-8750B
- AMD PRO A8-8650B
- AMD PRO A6-8570
- AMD PRO A6-8570E
- AMD PRO A4-8350B
- AMD A10-7890K
- AMD A10-7870K
- AMD A10-7850K
- AMD A10-7800
- AMD A10-7700K
- AMD A8-7670K
- AMD A8-7650K
- AMD A8-7600
- AMD A6-7400K

FreeSync2

AMD's FreeSync2 HDR content visualization improvement involves defining a panel characteristics requirement that produces twice the color volume of standard SDR panel and a protocol requiring the Sink Device to report the panel's true color chromaticities, min/max luminance, peak luminance, and supported transfer function.

Common HDR10 displays requires an application to map into generic luminance range and use industry standard color space that can be signaled through AVI and HDR Info Frame. This in turn requires Sink to perform tone mapping to map GPU output to actual luminance range and color gamut of the physical panel. Tone mapping by the monitor may increase post processing latency .

The FreeSync2 can allow content to be mapped directly to the display's native color gamut and luminance range to preserve HDR image quality while avoiding multiple inefficient tone mapping and preserving low latencies image update.

HDR

It is compatible with input signals in HDR10 format.

The display may automatically activate the HDR function if the player and content are compatible. Please contact the device manufacturer and the content provider for information on the compatibility of your device and content. Please select "OFF" for the HDR function when you have no need for automatical activation function.

Note:

1. No special setting is needed for the DisplayPort/HDMI interface in WIN10 versions lower (older) than V1703.
2. Only the HDMI interface is available and the DisplayPort interface cannot function in WIN10 version V1703.
3. 3840x2160 @50Hz /60Hz not suggestion used in PC device only for UHD player or Xbox-ones / PS4-Pro.
 - a. The display resolution is set to 3840*2160, and HDR is preset to ON. Under these conditions, the screen may slightly dim, indicating HDR has been activated.
 - b. After entering an application, the best HDR effect can be achieved when the resolution is changed to 3840*2160 (if available).

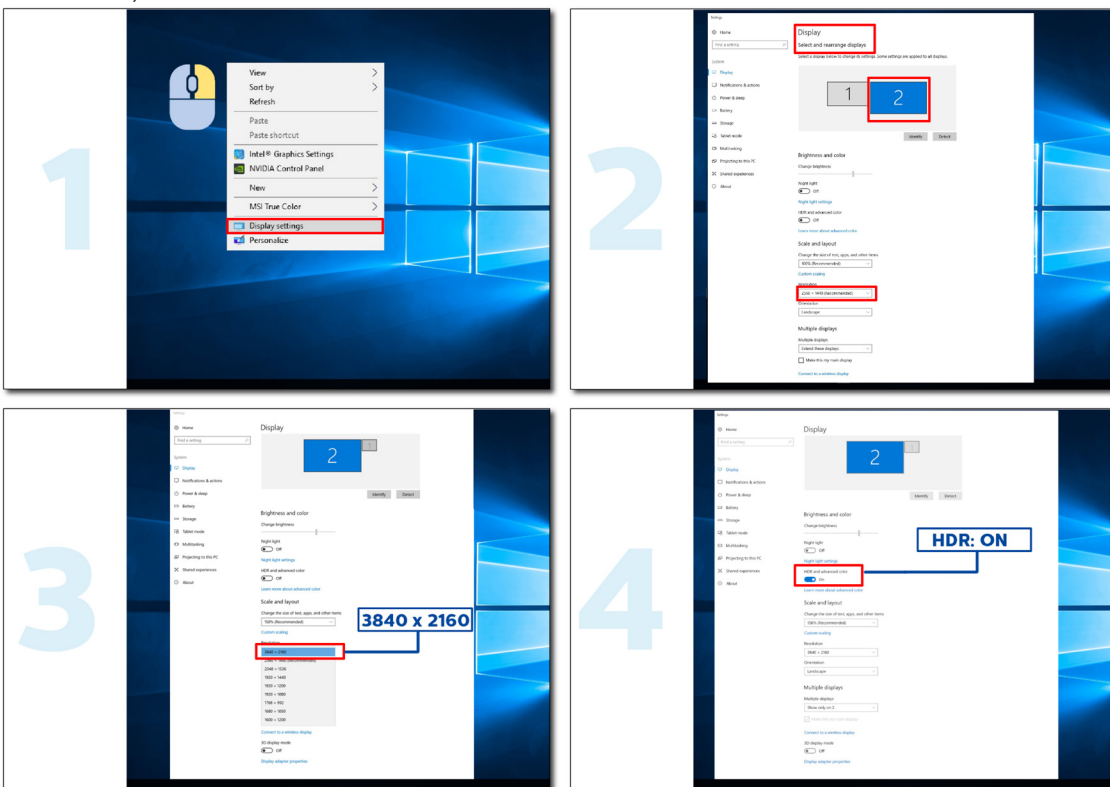

Hotkeys

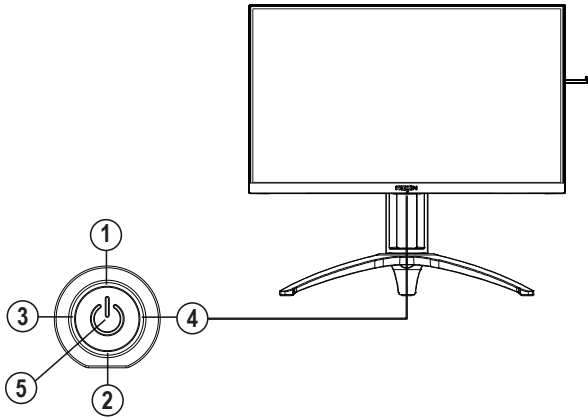

1	Source/Auto/Up
2	Dial Point/Down
3	Game Mode/Left
4	Light FX /Right
5	Power/ Menu/Enter

Power/Menu/Enter

Press the Power button to turn on the monitor.

When there is no OSD, Press to display the OSD or confirm the selection. Press about 2 seconds to turn off the monitor.

Dial Point/Down

When there is no OSD, press Dial Point button to show / hide Dial Point.

Game Mode/Left

When there is no OSD, press "Left" key to open game mode function, then press "Left" or "Right" key to select game mode (FPS, RTS, Racing, Gamer 1, Gamer 2 or Gamer 3) basing on the different game types.

Light FX/Right

When there is no OSD, press "Right" key to active Light FX function.

Source/Auto/Up

When the OSD is closed, press Source/Auto/Up button will be Source hot key function.

When the OSD is closed, press Source/Auto/Up button continuously about 2 seconds to do auto configure (Only for the models with D-Sub).

Quick Switch

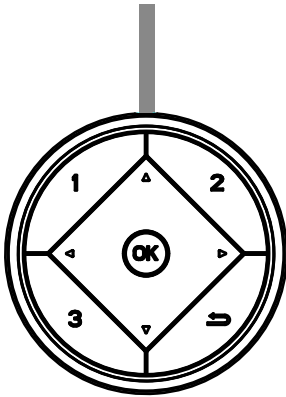

◀:

When there is no OSD, press the ◀ button to open game mode function, then press ◀ or ▶ key to select game mode (FPS, RTS, Racing, Gamer 1, Gamer 2 or Gamer 3) basing on the different game types.

▶:

When there is no OSD, press "Right" key to active Light FX function.

Menu/OK:

When there is no OSD, Press to display the OSD or confirm the selection.

▲:

When the OSD is closed, press ▲ button will be Source hot key function. When the OSD is closed, press Source/Auto/Exit button continuously about 2 seconds to do auto configure (Only for the models with D-Sub).

▼:

When there is no OSD, press Dial Point button to show / hide Dial Point.

1:

Press the 1 button to select Gamer 1 mode

2:

Press the 2 button to select Gamer 2 mode

3:

Press the 3 button to select Gamer 3 mode



Press to go back to the previous selection.

OSD Key Guide (Menu)



Enter : Use Enter key to enter the next OSD level
Move : Use Left / Up / Down key to move OSD selection
Exit : Use Right key to exit OSD



Enter : Use Enter key to enter the next OSD level
Move : Use Right / Up / Down key to move OSD selection
Exit : Use Left key to exit OSD



Enter : Use Enter key to enter the next OSD level
Move : Use Up / Down key to move OSD selection
Exit : Use Left key to exit OSD

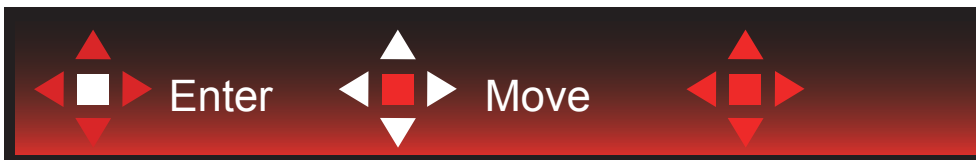

Move : Use Left / Right / Up / Down Key to move OSD selection



Exit : Use Left key to exit OSD to previous OSD level
Enter : Use Right key to enter next OSD level
Select : Use Up / Down key to move OSD selection



Enter : Use Enter key to apply the OSD setting and back to previous OSD level
Select : Use Down key to adjust OSD setting



Select : Use Up / Down key to adjust OSD setting



Enter : Use Enter key to exit OSD to previous OSD level

Select : Use Left / Right key to adjust OSD setting

OSD Setting

Basic and simple instruction on the control keys.

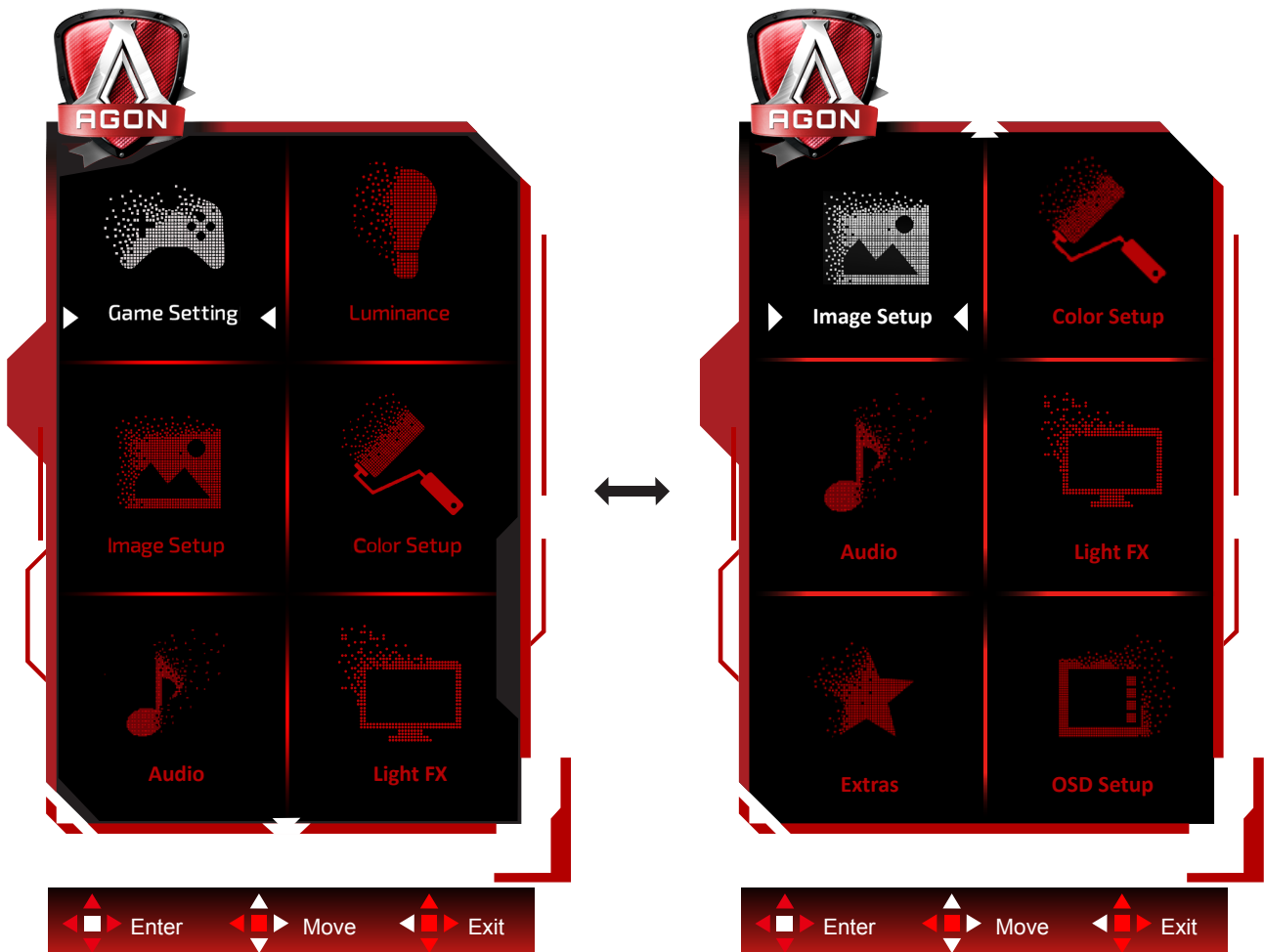



- 1). Press the MENU-button to activate the OSD window.
- 2). Follow Key Guide to move or select (adjust) OSD settings
- 3). OSD Lock/Unlock Function: To lock or unlock the OSD, press and hold the Down-button for 10s while OSD function is not active.

Notes:

- 1). If the product has only one signal input, the item of "Input Select" is disable to adjust.
- 2). ECO modes (except Standard mode), DCR, DCB mode and Picture Boost, for these four states that only one state can exist.

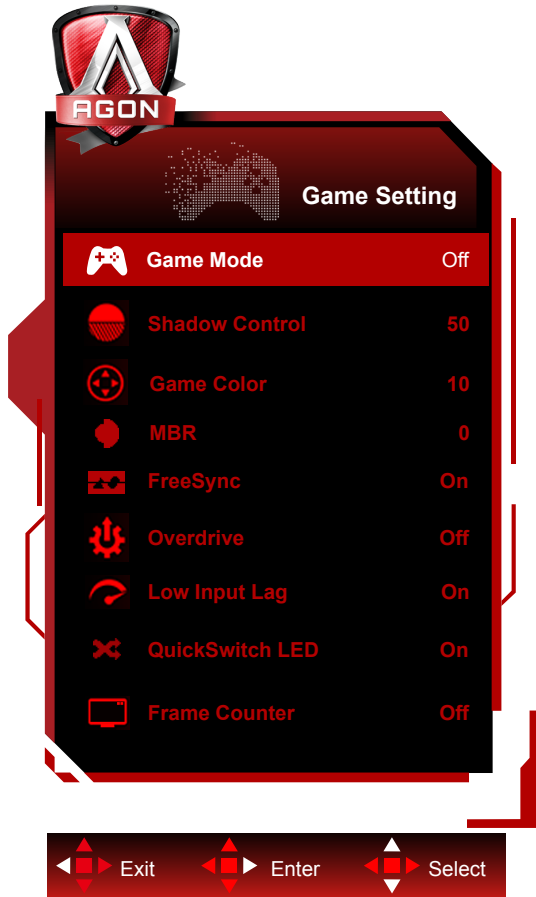
Game Setting





	Game Mode	FPS	For playing FPS (first Person Shooters) games. Improves dark theme black level details.
		RTS	For playing RTS (Real Time Strategy). Improves the image quality.
		Racing	For playing Racing games, Provides fastest response time and high color saturation.
		Gamer 1	User's preference settings saved as Gamer 1.
		Gamer 2	User's preference settings saved as Gamer 2.
		Gamer 3	User's preference settings saved as Gamer 3.
		off	No optimization by Smart image game
	Shadow Control	0-100	Shadow Control Default is 50, then end-user can adjust from 50 to 100 or 0 to increase contrast for clear picture. 1. If picture is too dark to be saw the detail clearly, adjusting from 50 to 100 for clear picture.. 2. If picture is too white to be saw the detail clearly, adjusting from 50 to 0 for clear picture
	Game Color	0-20	Game Color will provide 0-20 level for adjusting saturation to get better picture.
	MBR*	0-20	Adjust the Motion Blur Reduction.
	FreeSync	On / Off	Disable or Enable FreeSync.
	Overdrive	Weak/Medium/Strong/Boost*/Off	Adjust the response time.
Low Input lag	On / Off	Turn off frame buffer to decrease input lag	
QuickSwitch LED	On / Off	Disable or Enable QuickSwitch LED	
Frame Counter	Off / Right-Up / Right-Down / Left-Down / Left-Up	Display V frequency on the corner selected	

Note:

The function MBR and Overdrive Boost are available only when FreeSync is off and the vertical frequency is up to 75 Hz.

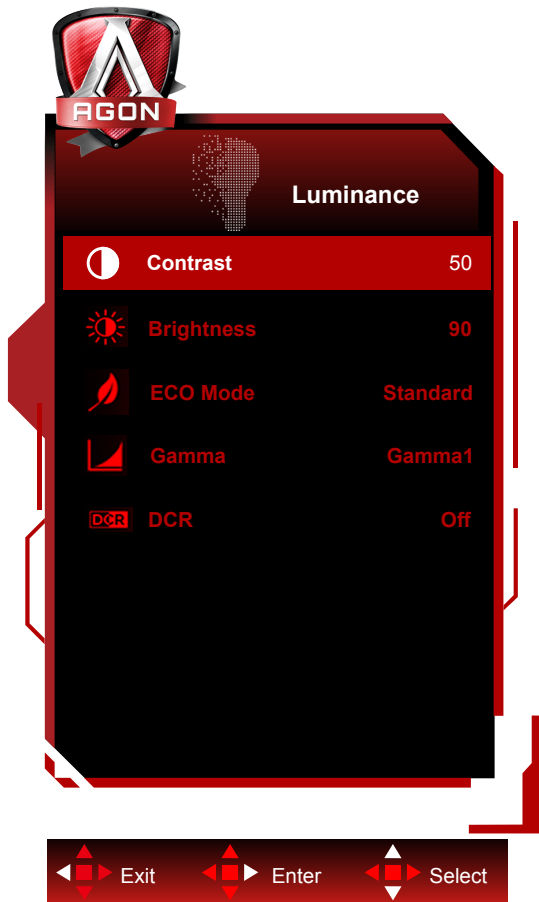
Luminance



	Contrast	0-100	Contrast from Digital-register.	
	Brightness	0-100	Backlight Adjustment	
	Eco mode	Standard		Standard Mode
		Text		Text Mode
		Internet		Internet Mode
		Game		Game Mode
		Movie		Movie Mode
	Gamma	Sports		Sports Mode
		Gamma1		Adjust to Gamma 1
		Gamma2		Adjust to Gamma 2
DCR	Gamma3		Adjust to Gamma 3	
	Off/On		Disable/ Enable dynamic contrast ratio	

Note:

When HDR under Image Setup is set to Auto & Input Source has HDR content, ECO mode will become HDR / HDR Picture / HDR Movie / HDR Game

Image Setup

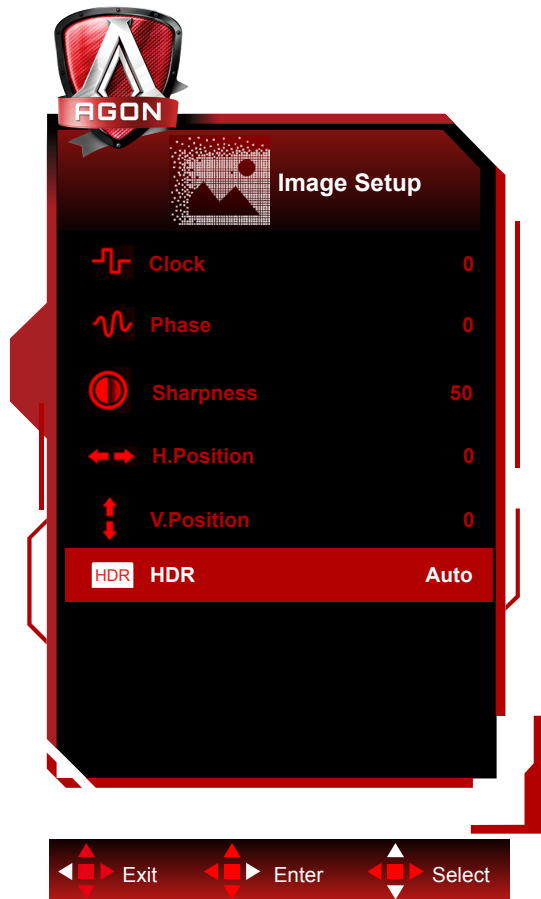

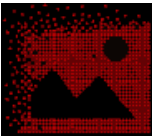
	Clock	0-100	Adjust picture Clock to reduce Vertical-Line noise.
	Phase	0-100	Adjust Picture Phase to reduce Horizontal-Line noise
	Sharpness	0-100	Adjust picture sharpness
	H. Position	0-100	Adjust the horizontal position of the picture.
	V. Position	0-100	Adjust the vertical position of the picture.
	HDR	Off/Auto	Disable or Enable HDR

Color Setup

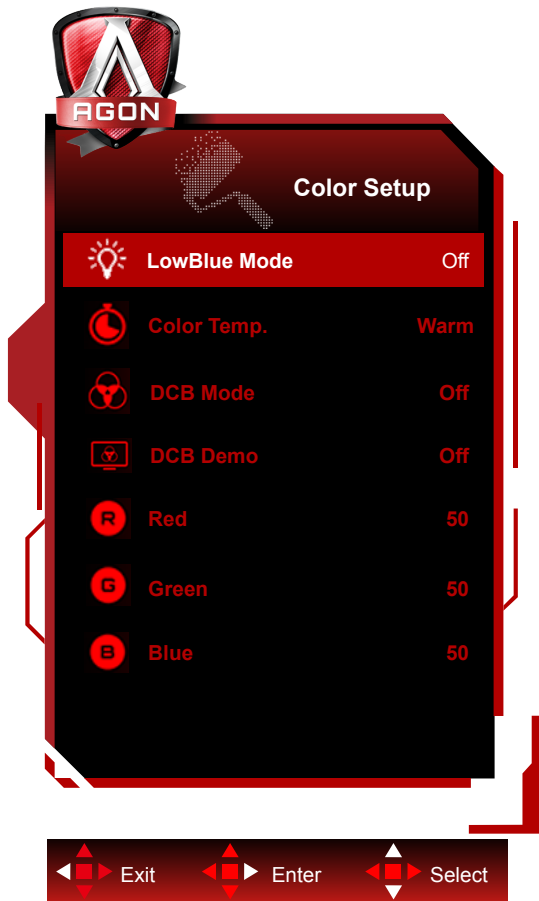

	LowBlue Mode	Off / Multimedia / Internet / Office / Reading		Decrease blue light wave by controlling color temperature.
	Color Temp.	Warm		Recall Warm Color Temperature from EEPROM.
		Normal		Recall Normal Color Temperature from EEPROM.
		Cool		Recall Cool Color Temperature from EEPROM.
		sRGB		Recall SRGB Color Temperature from EEPROM.
	User	Red		Red Gain from Digital-register
		Green		Green Gain Digital-register.
		Blue		Blue Gain from Digital-register
	DCB Mode	Full Enhance	on or off	Disable or Enable Full Enhance Mode
		Nature Skin	on or off	Disable or Enable Nature Skin Mode
		Green Field	on or off	Disable or Enable Green Field Mode
		Sky-blue	on or off	Disable or Enable Sky-blue Mode
		AutoDetect	on or off	Disable or Enable AutoDetect Mode
DCB Demo		on or off	Disable or Enable Demo	

Audio

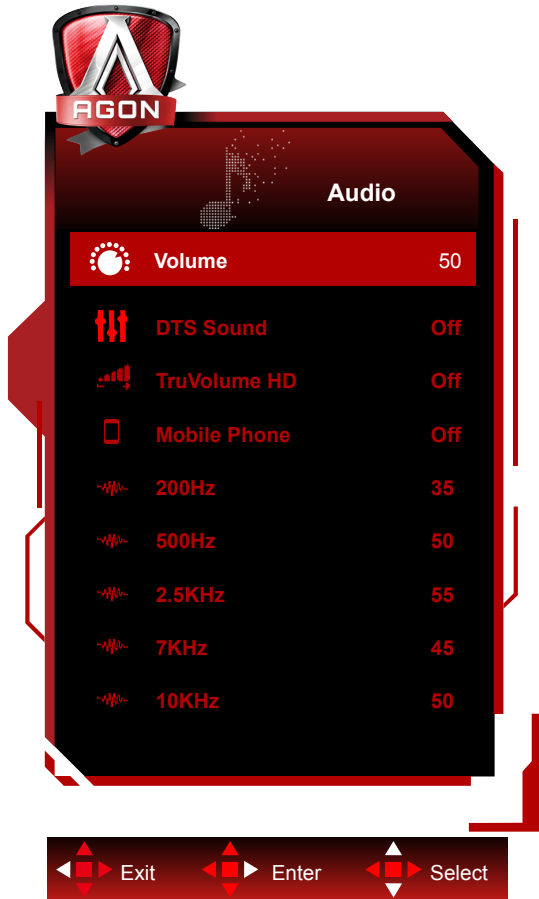

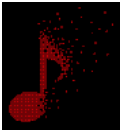
	Volume	0-100	Adjust volume setting
	DTS Sound	Game / Rock / Classical / Live / Theater / Off	Select DTS Sound mode. Note: It may take up to 2 seconds to switch modes.
	TruVolume HD	On / Off	Disable or Enable TruVolume HD.
	Mobile Phone*	On / Off	Disable or Enable Mobile Phone. Note: Only support the source of VGA.
	200Hz	0-100	Low frequency base audio, also the root audio frequency of the chord in the tone.
	500Hz	0-100	Mainly used to express vocals (eg. singing, reading), Strengthen the thickness and strength of vocals.
	2.5KHz	0-100	This frequency has a strong penetrating power and can be improved to improve the brightness and clarity of the sound.
	7KHz	0-100	Enhance the clarity of vocals.
	10KHz	0-100	The high-pitched area of music is most sensitive to the high-frequency performance of the sound.

Light FX

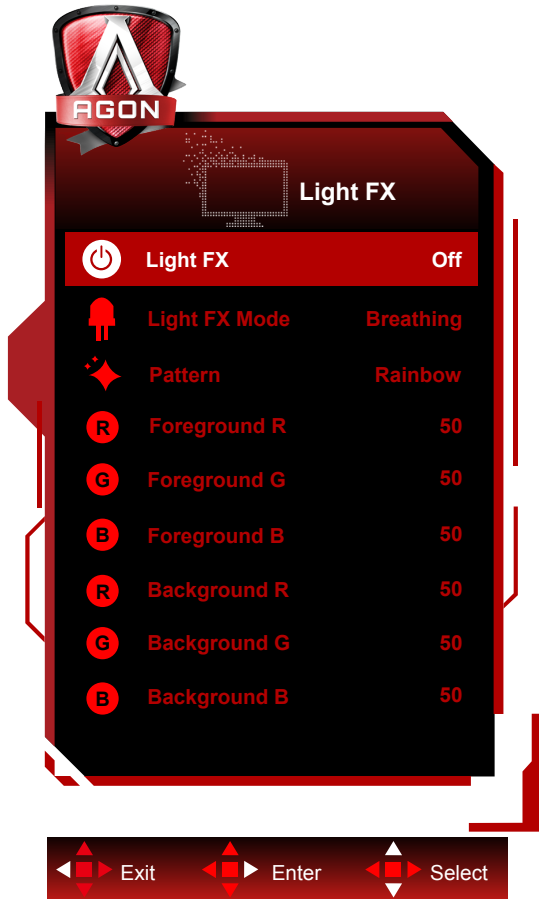

	Light FX	Off / Low / Medium / Strong	Select the intensity of Light FX.
	Light FX Mode	Audio / Static / Simple Shift / Gradient Shift / Simple filling / 1 way filling / 2 way filling / Breathing / Motion Point / Zoom / Discolor / Water Wave / Flashing / Demo	Select Light FX Mode
	Pattern	Red / Green / Blue / Rainbow / User Define	Select Light FX Pattern
	Foreground R	0-100	User can adjust Light FX foreground color, when Pattern setting to user define
	Foreground G		
	Foreground B		
	Background R	0-100	User can adjust Light FX background color, when Pattern setting to user define
Background G			
Background B			

Extra

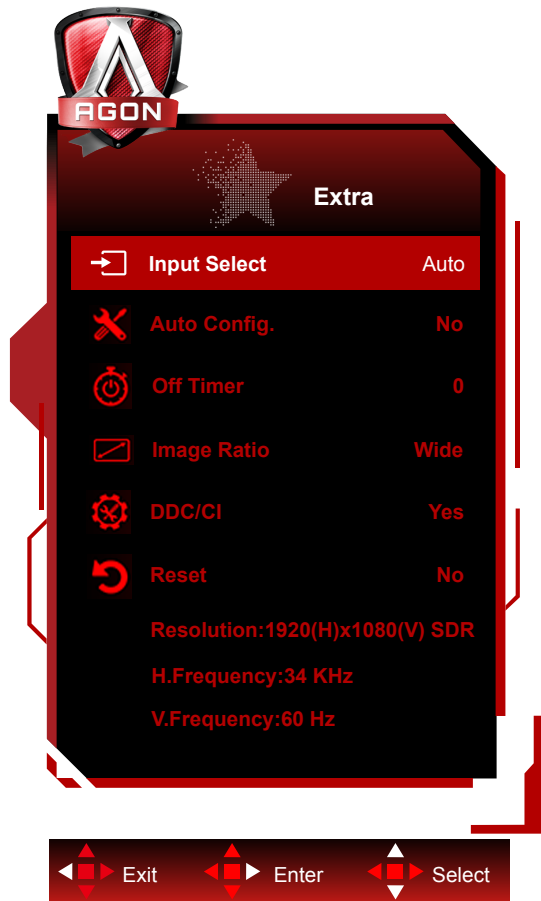

	Input Select	AUTO/D-SUB/ HDMI1/HDMI2/ DP1/DP2	Select Input Signal Source
	Auto Config	Yes or No	Auto adjust the picture to default
	Off timer	0-24hrs	Select DC off time
	Image Ratio	Wide / 4:3 / 1:1 / 17"(4:3) / 19"(4:3) / 19"(5:4) / 19"W(16:10) / 21.5"W(16:9) / 22"W(16:10) / 23"W(16:9) / 23.6"W(16:9) / 24"W(16:9)	Select image ratio for display.
	DDC/CI	Yes or No	Turn ON/OFF DDC/CI Support
	Reset	Yes or No	Reset the menu to default

OSD Setup

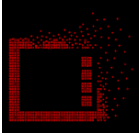

	Language		Select the OSD language
	Timeout	5-120	Adjust the OSD Timeout
	DP Capability	1.1/1.2	please be noted that only DP1.2 support free sync function
	H. Position	0-100	Adjust the horizontal position of OSD
	V. Position	0-100	Adjust the vertical position of OSD
	Transparence	0-100	Adjust the transparence of OSD
	Break Reminder	on /off	Break reminder if the user continuously work for more than 1hrs

Note:

If the DP video content supports DP1.2, please select DP1.2 for DP Capability; otherwise, please select DP1.1

LED Indicator

Status	LED Color
Full Power Mode	Red
Active-off Mode	Orange

Troubleshoot

Problem & Question	Possible Solutions
Power LED Is Not ON	Make sure the power button is ON and the Power Cord is properly connected to a grounded power outlet and to the monitor.
No images on the screen	<ul style="list-style-type: none"> • Is the power cord connected properly? Check the power cord connection and power supply. • Is the cable connected correctly? (Connected using the D-SUB cable) Check the D-SUB cable connection. (Connected using the HDMI cable) Check the HDMI cable connection. (Connected using the DP cable) Check the DP cable connection. *D-SUB/HDMI/DP input is not available on every model. • If the power is on, reboot the computer to see the initial screen (the login screen), which can be seen. If the initial screen (the login screen) appears, boot the computer in the applicable mode (the safe mode for Windows 7/8/10) and then change the frequency of the video card. (Refer to the Setting the Optimal Resolution) If the initial screen (the login screen) does not appear, contact the Service Center or your dealer. • Can you see "Input Not Supported" on the screen? You can see this message when the signal from the video card exceeds the maximum resolution and frequency that the monitor can handle properly. Adjust the maximum resolution and frequency that the monitor can handle properly. • Make sure the AOC Monitor Drivers are installed.
Picture Is Fuzzy & Has Ghosting Shadowing Problem	Adjust the Contrast and Brightness Controls. Press to auto adjust. Make sure you are not using an extension cable or switch box. We recommend plugging the monitor directly to the video card output connector on the back.
Picture Bounces, Flickers Or Wave Pattern Appears In The Picture	Move electrical devices that may cause electrical interference as far away from the monitor as possible. Use the maximum refresh rate your monitor is capable of at the resolution you are using.
Monitor Is Stuck In Active Off-Mode"	The Computer Power Switch should be in the ON position. The Computer Video Card should be snugly fitted in its slot. Make sure the monitor's video cable is properly connected to the computer. Inspect the monitor's video cable and make sure no pin is bent. Make sure your computer is operational by hitting the CAPS LOCK key on the keyboard while observing the CAPS LOCK LED. The LED should either turn ON or OFF after hitting the CAPS LOCK key.
Missing one of the primary colors (RED, GREEN, or BLUE)	Inspect the monitor's video cable and make sure that no pin is damaged. Make sure the monitor's video cable is properly connected to the computer.
Screen image is not centered or sized properly	Adjust H-Position and V-Position or press hot-key (AUTO).
Picture has color defects (white does not look white)	Adjust RGB color or select desired color temperature.
Horizontal or vertical disturbances on the screen	Use Windows 7/8/10 shut-down mode to adjust CLOCK and FOCUS. Press to auto-adjust.

Specification

General Specification

Panel	Model name	AG273QCX		
	Driving system	TFT Color LCD		
	Viewable Image Size	68.5 cm diagonal		
	Pixel pitch	0.2331mm(H) x 0.2331mm(V)		
	Video	R, G, B Analog Interface & HDMI Interface & DP Interface		
	Separate Sync.	H/V TTL		
	Display Color	16.7M Colors		
Others	Horizontal scan range	VGA/HDMI1.4+HDR: 30 - 160KHz (H) HDMI2.0/DP1.4: 30 - 230KHz(H)		
	Horizontal scan Size(Maximum)	596.74mm		
	Vertical scan range	VGA/HDMI2.0/DP1.4: 48 - 144Hz(V)		
	Vertical Scan Size(Maximum)	335.66mm		
	Optimal preset resolution	VGA: 1920 x 1080@60Hz HDMI2.0/DP1.4: 2560 x 1440@60Hz		
	Max resolution	VGA: 1920 x 1080@60Hz HDMI1.4+HDR: 2560x1440@75Hz HDMI2.0/DP1.4: 2560 x 1440@144Hz		
	Plug & Play	VESA DDC2B/CI		
	Input Connector	VGA/HDMI/DP/Line in/Microphone In		
	Input Video Signal	Analog: 0.7Vp-p(standard), 75 OHM, TMDS		
	Output Connector	Earphone out/Microphone in		
	Power Source	100-240V~, 1.5A, 50/60Hz		
	Power Consumption	Typical(Brightness = 90, Contrast = 50)	50W	
		Max. (brightness = 100, contrast =100)	≤90W	
Power saving		≤0.5W		
Off timer	0~24 hrs			
Physical Characteristics	Connector Type	VGA/ HDMI/ DP/ Earphone out/ Microphone In		
	Signal Cable Type	Detachable		
Environmental	Temperature	Operating	0°~ 40°	
		Non-Operating	-25°~ 55°	
	Humidity	Operating	10% ~ 85% (non-condensing)	
		Non-Operating	5% ~ 93% (non-condensing)	
	Altitude	Operating	0~ 5000 m (0~ 16404ft)	
Non-Operating		0~ 12192m (0~ 40000ft)		

Preset Display Modes

STANDARD	RESOLUTION	HORIZONTAL FREQUENCY(kHz)	VERTICAL FREQUENCY(Hz)
VGA	640x480@60Hz	31.469	59.94
VGA	640x480@67Hz	35	66.667
VGA	640x480@72Hz	37.861	72.809
VGA	640x480@75Hz	37.5	75
VGA	640x480@100Hz	51.08	99.769
VGA	640x480@120Hz	61.91	119.518
DOS MODE	720x400@70Hz	31.469	70.087
DOS MODE	720x480@60Hz	29.855	59.710
SD	720x576@50Hz	31.25	50
SVGA	800x600@56Hz	35.156	56.25
SVGA	800x600@60Hz	37.879	60.317
SVGA	800x600@72Hz	48.077	72.188
SVGA	800x600@75Hz	46.875	75
SVGA	800x600@100Hz	63.684	99.662
SVGA	800x600@120Hz	76.302	119.97
SVGA	832x624@75Hz	49.725	74.551
XGA	1024x768@60Hz	48.363	60.004
XGA	1024x768@70Hz	56.476	70.069
XGA	1024x768@75Hz	60.023	75.029
XGA	1024x768@100Hz	81.577	99.972
XGA	1024x768@120Hz	97.551	119.989
SXGA	1280x1024@60Hz	63.981	60.02
SXGA	1280x1024@75Hz	79.975	75.025
Full HD	1920x1080@60Hz	67.5	60
FHD	1920x1080@100Hz	113.221	99.93
FHD	1920x1080@120Hz	137.26	119.982
QHD	2560x1440@60Hz	88.787	59.951
QHD	2560x1440@75Hz	111.028	74.968
QHD	2560x1440@120Hz	182.817	119.880
QHD	2560x1440@144Hz	222.056	143.912

Pin Assignments



Pin No.	Signal Name	Pin No.	Signal Name	Pin No.	Signal Name
1.	TMDS Data 2+	9.	TMDS Data 0-	17.	DDC/CEC Ground
2.	TMDS Data 2 Shield	10.	TMDS Clock +	18.	+5V Power
3.	TMDS Data 2-	11.	TMDS Clock Shield	19.	Hot Plug Detect
4.	TMDS Data 1+	12.	TMDS Clock-		
5.	TMDS Data 1Shield	13.	CEC		
6.	TMDS Data 1-	14.	Reserved (N.C. on device)		
7.	TMDS Data 0+	15.	SCL		
8.	TMDS Data 0 Shield	16.	SDA		

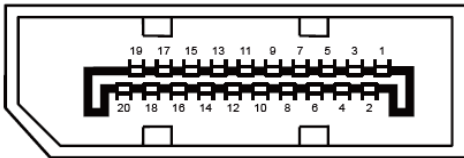

20-Pin Color Display Signal Cable

Pin No.	Signal Name	Pin No.	Signal Name
1	ML_Lane 3 (n)	11	GND
2	GND	12	ML_Lane 0 (p)
3	ML_Lane 3 (p)	13	CONFIG1
4	ML_Lane 2 (n)	14	CONFIG2
5	GND	15	AUX_CH(p)
6	ML_Lane 2 (p)	16	GND
7	ML_Lane 1 (n)	17	AUX_CH(n)
8	GND	18	Hot Plug Detect
9	ML_Lane 1 (p)	19	Return DP_PWR
10	ML_Lane 0 (n)	20	DP_PWR

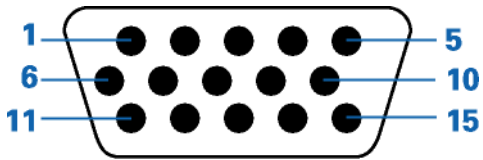

15-Pin Color Display Signal Cable

Pin Number	15-Pin Side of the Signal Cable	Pin Number	15-Pin Side of the Signal Cable
1	Video-Red	9	+5V
2	Video-Green	10	Ground
3	Video-Blue	11	N.C.
4	N.C.	12	DDC-Serial data
5	Detect Cable	13	H-sync
6	GND-R	14	V-sync
7	GND-G	15	DDC-Serial clock
8	GND-B		

Plug and Play

Plug & Play DDC2B Feature

This monitor is equipped with VESA DDC2B capabilities according to the VESA DDC STANDARD. It allows the monitor to inform the host system of its identity and, depending on the level of DDC used, communicate additional information about its display capabilities.

The DDC2B is a bi-directional data channel based on the I2C protocol. The host can request EDID information over the DDC2B channel.



For DTS patents, see <http://patents.dts.com>. Manufactured under license from DTS Licensing Limited. DTS, the Symbol, & DTS and the Symbol together are registered trademarks, and DTS Sound is a trademark of DTS, Inc. © DTS, Inc. All Rights Reserved.

G-Menu



Welcome to "G-Menu" software by AOC. G-Menu makes it easy to adjust your monitor display setting by using on screen menus instead of the OSD button on the monitor. To complete installation, please follow the installation guide. The software Supported operating systems: Windows 10, Windows 8, Windows 7.

Note:

Features are not available for all models.

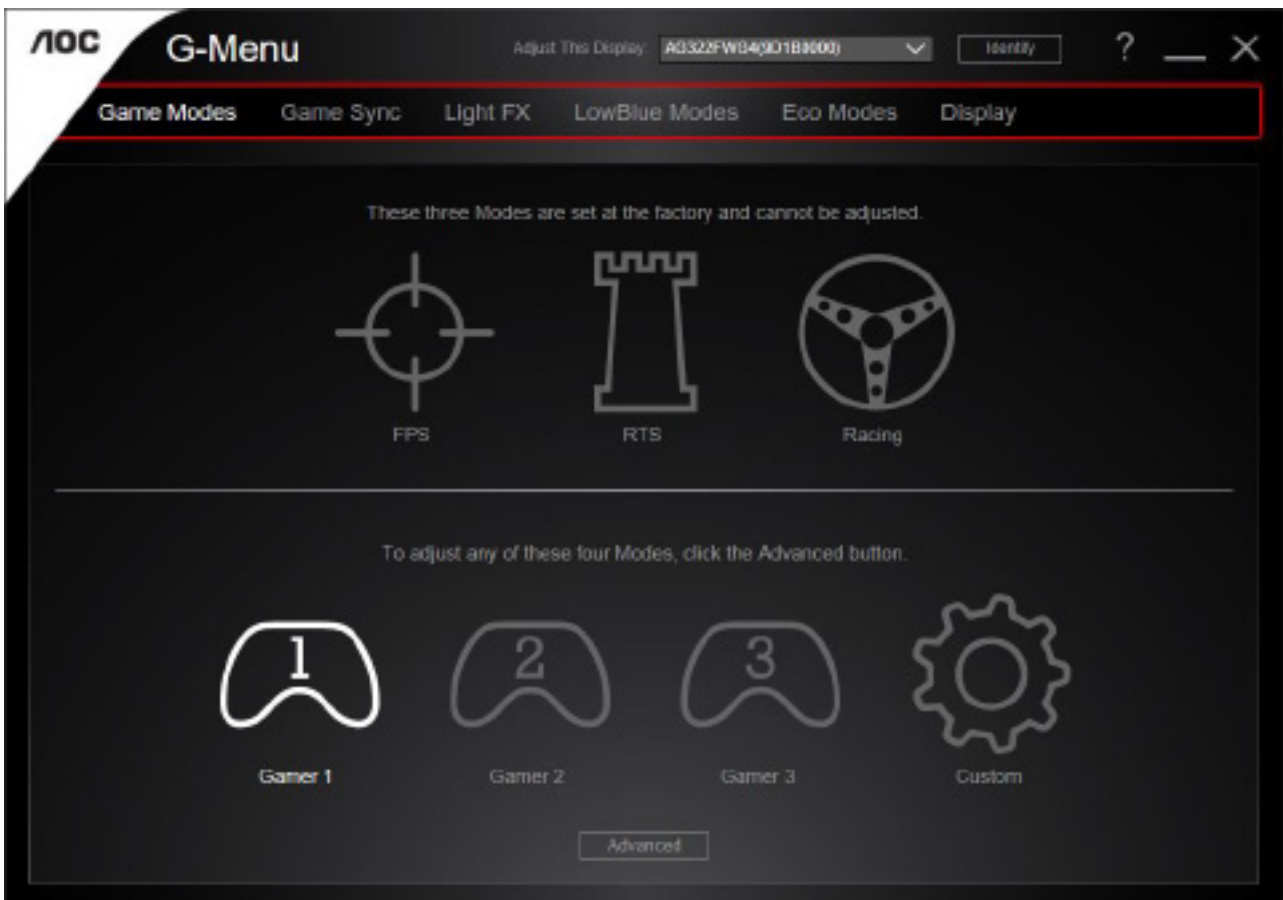

e-Saver



Welcome to use AOC e-Saver monitor power management software! The AOC e-Saver features Smart Shutdown functions for your monitors, allows your monitor to timely shutdown when PC unit is at any status (On, Off, Sleep or Screen Saver); the actual shutdown time depends on your preferences (see example below).

Please click on “driver/e-Saver/setup.exe” to start installing the e-Saver software, follow the install wizard to complete software installation.

Under each of the four PC status, you may choose from the pull-down menu the desired time (in minutes) you're your monitor to automatically shut down. The example above illustrated:

- 1). The monitor will never shutdown when the PC is powered on.
- 2). The monitor will automatically shutdown 5 minutes after the PC is powered off.
- 3). The monitor will automatically shutdown 10 minutes after the PC is in sleep/stand-by mode.
- 4). The monitor will automatically shutdown 20 minutes after the screen saver appears.

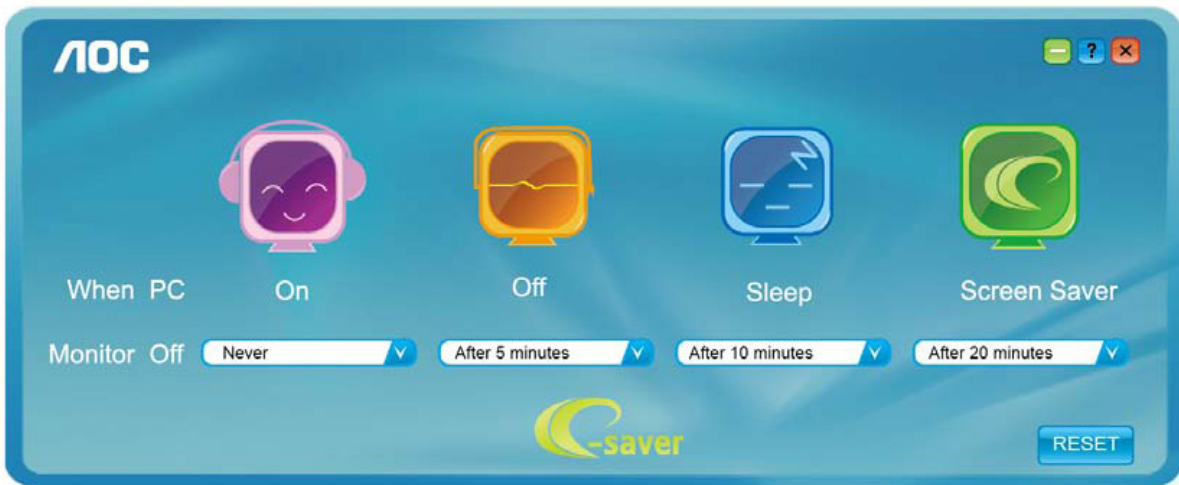

You can click “RESET” to set the e-Saver to its default settings like below.

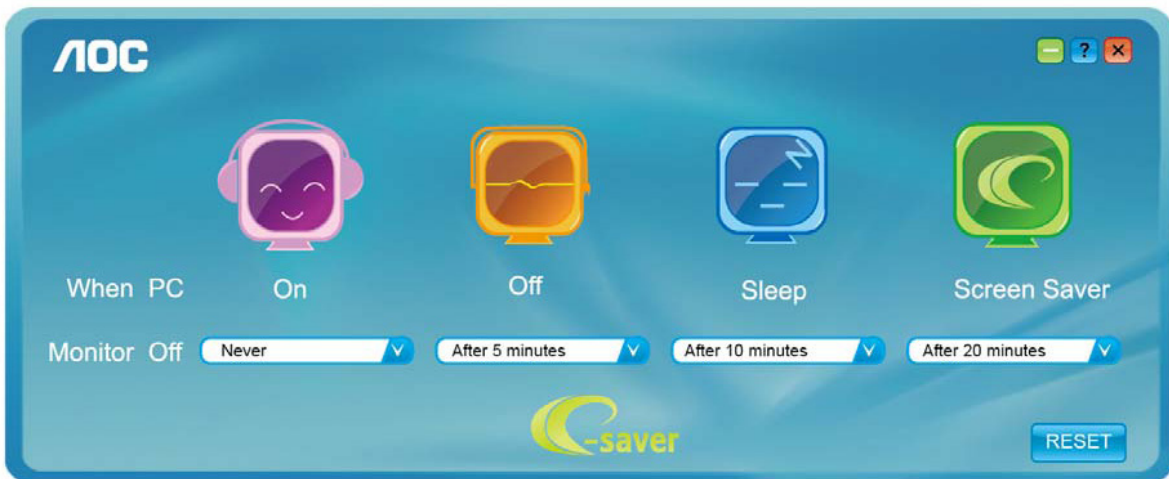

Screen+



Welcome to “Screen+” software by AOC. Screen+ software is a desktop screen splitting tool; it splits the desktop into different panels, and each panel displays a different window. You only need to drag the window to a corresponding panel when you want to access it. It supports multiple monitor display to make your task easier. Please follow the installation software to install it. The software Supported operating systems: Windows 10 , Windows 8, Windows 7.

