

IEC SYSTEM FOR MUTUAL RECOGNITION OF TEST
CERTIFICATES FOR ELECTRICAL EQUIPMENT
(IECEE) CB SCHEME

SYSTEME CEI D'ACCEPTATION MUTUELLE DE
CERTIFICATS D'ESSAIS DES EQUIPEMENTS
ELECTRIQUES (IECEE) METHODE OC

CB TEST CERTIFICATE

CERTIFICAT D'ESSAI OC

Product
Produit

LCD monitor

Name and address of the applicant
Nom et adresse du demandeur

TPV Electronics (Fujian) Co., Ltd.
Shangzheng, Yuan Hong Road
Fuqing City, Fujian Province, P.R. China

Name and address of the manufacturer
Nom et adresse du fabricant

TPV Electronics (Fujian) Co., Ltd.
Shangzheng, Yuan Hong Road
Fuqing City, Fujian Province, P.R. China

Name and address of the factory
Nom et adresse de l'usine

See additional page(s)

Ratings and principal characteristics
Valeurs nominales et caractéristiques principales

DC 19V; 3.42A; Class III

Trademark (if any)
Marque de fabriquer (si elle existe)

AOC

Type of Manufacturer's Testing Laboratories used
Type de programme du laboratoire d'essais constructeur

N/A

Model / Type Ref.
Ref. de type

215LM000**, *2272*****, 236LM000**, *2472*****
(* = 0-9, A-Z, a-z, -, \, /, + or blank)

Additional information (if necessary may also be reported on page 2)
Les informations complémentaires (si nécessaire, peuvent être indiqués sur la 2^{ème} page)

For model differences, refer to the test report.

A sample of the product was tested and found to be in conformity with
Un échantillon de ce produit a été essayé et a été considéré conforme à la

IEC 60950-1:2005 + A1
National differences see test report

As shown in the Test Report Ref. No. which forms part of this Certificate
Comme indiqué dans le Rapport d'essais numéro de référence qui constitue partie de ce Certificat

17028398 001

This CB Test Certificate is issued by the National Certification Body
Ce Certificat d'essai OC est établi par l'Organisme National de Certification



TÜV Rheinland Japan Ltd.
Global Technology Assessment Center
4-25-2 Kita-Yamata, Tsuzuki-ku
Yokohama 224-0021 Japan
Phone + 81 45 914-3888
Fax + 81 45 914-3354
Mail: info@jpn.tuv.com
Web: www.tuv.com

Date: 23.08.2013

Signature:

Dipl.-Ing. Univ. S. O. Steinke

1. TPV Technology (Beijing) Co., Ltd.
No. 10, Jiu Xian Qiao Rd.
Chao Yang District, Beijing 100016
P.R. China
2. Tatung Mexico S.A. de. C.V.
Ave. Rosa Ma. Fuentes #7050
Complejo Industrial Fuentes
C.P. 32320, Cd. Juarez. Chih,
MEXICO
3. TPV Display Technology (Wuhan)
Co., Ltd.
Unique No. 11, Zhuankou Development
District of Economic Technological
Development Zone, Wuhan City 430056, P.R. China
4. TPV Electronics (Fujian) Co., Ltd.
Shangzheng, Yuan Hong Road
Fuqing City, Fujian Province
P.R. China
5. Envision Industry of Electronic
Products Ltd.
895, Joao Marcos Pozzetti Street,
Industrial District II,
69.075-215 Manaus, Am, Brazil
6. Tatung Czech s.r.o
U Nove Hospody 4
30100 Plzen
Czech Republic
7. Envision Industry of Electronic
Products Ltd.
Rodovia Anhanguera S/N-KM 49
13.205-700 Tijuco Preto-Jundiaí-SP-
Brazil
8. TPV Displays Polska Sp. z o.o.
ul. Zlotego Smoka 9
66-400 Gorzów Wlkp.
Poland
9. L&T Display Technology (Fujian) Ltd.
Optoelectronic Park, Rongqiao
Economic and Technological
Development Zone
Fuqing, Fujian 350301, P.R. China

Additional information (if necessary)
Information complémentaire (si nécessaire)

Report Ref. No.: 17028398 001

Date: 23.08.2013

Signature:

Dipl.-Ing. Univ. S. O. Steinke

10. Trend Smart CE Mexico S de RL de CV
Avenida Sor Juana Ines de la Cruz
de 19602 Nueva Tijuana,
22435 Tijuana Baja California
MEXICO
11. TPV Display Technology (Beihai)
Co., Ltd.
China Electronic Beihai Industry
Park, Northeast of the Crossing
Between Taiwan Road and Jilin Road, Beihai City, Guangxi, P.R. China
12. Envision Industry of Electronic
Products Ltd.
Av Torquato Tapajós 7503,
Galpão : II Bloco: B-Condomínio
de Galpões-Tarumã-Manaus, AM, Brazil
13. TPV Technology (Qingdao)
Co., Ltd.
No.99 Huoju Road, High-tech Industrial
Development Zone
Qingdao City, Shandong Province, P.R. China
14. TPV Display Technology (China)
Co., Ltd.
No. 106 Jinghai 3 Rd., BDA
Beijing City 100176
P.R. China

Additional information (if necessary)
Information complémentaire (si nécessaire)

Report Ref. No.: 17028398 001

Date: 23.08.2013

Signature:

Dipl.-Ing. Univ. S. O. Steinke



Test Report issued under the responsibility of:



| | |
|--|---|
| TEST REPORT | |
| IEC 60950-1 | |
| Information technology equipment – Safety – Part 1: General requirements | |
| Report Number | 17028398 001 |
| Date of issue..... | 21.Aug.2013 |
| Total number of pages | 43 pages |
| CB Testing Laboratory | TÜV Rheinland (Shenzhen) Co., Ltd. |
| Address | 3 & 4 F, Cybio Technology Building No. 1, Langshan No. 2 Road South, 5th Industrial Area, High-Tech Industry Park North, Nanshan District, 518057, Shenzhen, P.R. China |
| Applicant's name | TPV Electronics (Fujian) Co., Ltd. |
| Address | Shangzheng, Yuan Hong Road, Fuqing City, Fujian Province, P.R. China |
| Manufacturer's name | Same as applicant |
| Address | Same as applicant |
| Test specification: | |
| Standard | IEC 60950-1:2005 (Second Edition); Am 1:2009 |
| Test procedure | CB Scheme |
| Non-standard test method..... | N/A |
| Test Report Form No. | IEC60950_1C |
| Test Report Form(s) Originator | SGS Fimko Ltd |
| Master TRF..... | Dated 2012-08 |
| Copyright © 2012 Worldwide System for Conformity Testing and Certification of Electrotechnical Equipment and Components (IECEE), Geneva, Switzerland. All rights reserved. | |
| This publication may be reproduced in whole or in part for non-commercial purposes as long as the IECEE is acknowledged as copyright owner and source of the material. IECEE takes no responsibility for and will not assume liability for damages resulting from the reader's interpretation of the reproduced material due to its placement and context. | |
| If this Test Report Form is used by non-IECEE members, the IECEE/IEC logo and the reference to the CB Scheme procedure shall be removed. | |
| This report is not valid as a CB Test Report unless signed by an approved CB Testing Laboratory and appended to a CB Test Certificate issued by an NCB in accordance with IECEE 02. | |
| Test item description | LCD monitor |
| Trade Mark | AOC |
| Manufacturer | See above |
| Model/Type reference..... | 215LM000**, *2272*****, 236LM000**, *2472*****, (* can be 0-9, A-Z, a-z, -, \, /, + or blank, represent different enclosure colour for marketing purpose) |

Ratings.....: I/P: 19Vdc, 3.42A

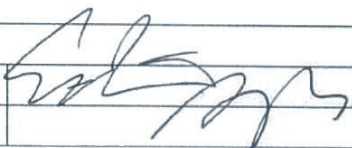
| Testing procedure and testing location: | | |
|---|----------------------------------|---|
| <input checked="" type="checkbox"/> | CB Testing Laboratory: | TÜV Rheinland (Shenzhen) Co., Ltd. |
| Testing location/ address.....: | | 3 & 4 F, Cybio Technology Building No. 1, Langshan No. 2 Road South, 5th Industrial Area, High-Tech Industry Park North, Nanshan District, 518057, Shenzhen, P.R. China |
| <input type="checkbox"/> | Associated CB Laboratory: | N/A |
| Testing location/ address.....: | | N/A |
| Tested by (name + signature).....: | | Steven Lin  |
| Approved by (name + signature).....: | | Aegean Li |
| <input type="checkbox"/> | Testing procedure: TMP | N/A |
| Testing location/ address.....: | | N/A |
| Tested by (name + signature).....: | | |
| Approved by (name + signature).....: | | |
| <input type="checkbox"/> | Testing procedure: WMT | N/A |
| Testing location/ address.....: | | N/A |
| Tested by (name + signature).....: | | |
| Witnessed by (name + signature).....: | | |
| Approved by (name + signature).....: | | |
| <input type="checkbox"/> | Testing procedure: SMT | N/A |
| Testing location/ address.....: | | N/A |
| Tested by (name + signature).....: | | |
| Approved by (name + signature).....: | | |
| Supervised by (name + signature).....: | | |
| <input type="checkbox"/> | Testing procedure: RMT | N/A |
| Testing location/ address.....: | | N/A |
| Tested by (name + signature).....: | | |
| Approved by (name + signature).....: | | |
| Supervised by (name + signature).....: | | |

List of Attachments (including a total number of pages in each attachment):

- Photo documentation
- National Differences

Total number of pages in each attachment is indicated in individual attachment.

Summary of testing:**Tests performed (name of test and test clause):**

The tests were carried out under the most unfavorable combination within the manufacturer's operating specifications of the following parameters:

- supply voltage 19Vdc
- operating temperature, Max. ambient temperature 40°C declared by the client
- operating mode: continuous
- operating load:
maximum brightness, maximum contrast, full white screen;
speakers were loaded with 1KHz sinusoidal signal and adjusted to maximum volume; each USB2.0 port loaded 5V/0.5A; each USB3.0 port loaded 5V/0.9A, quickly charge USB port loaded 5V/1.5A.

The critical tests were performed for this equipment included clauses:

| name of test | test clause number |
|-------------------------------------|---------------------------|
| Input Current Test | 1.6.2 |
| Durability of Marking Test | 1.7.11 |
| SELV limits for normal conditions | 2.2.2 |
| SELV limits for abnormal conditions | 2.2.3 |
| Maximum Temperature Test | 4.5.2 |
| Fault Condition Test | 5.3 |

The EUT passed the test.

Testing location:

All tests as described in Test Case and Measurement Sections were performed at the laboratory described on page 2

Summary of compliance with National Differences

List of countries addressed:

EU Group Differences, EU Special National Conditions, EU A-Deviations, AT, AU*, BE, CA, CH, CN, CZ, DE, DK, FI, FR, GB, GR, HU, IT, IL, JP#, KR, NL, NO, PL, SE, SI, SK, US

Explanation of used codes: AT=Austria, AU=Australia, BE=Belgium, CA=Canada, CH=Switzerland, CN=China, CZ=Czech Republic, DE=Germany, DK=Denmark, FI=Finland, FR=France, GB=United Kingdom, GR=Greece, HU=Hungary, IT=Italy, IL=Israel, JP=Japan, KR=Korea, NL=The Netherlands, NO=Norway, PL=Poland, SE=Sweden, SI=Slovenia, SK=Slovakia, US=United States of America

For National Differences see end of this test report.

* National differences to IEC 60950-1:2005 evaluated.

National differences to IEC 60950-1:2001 evaluated.

Japan deviations J60950-1 (H22) and J3000 (H21) both covered.

The product fulfils the requirements of EN 60950-1: 2006 + A11:2009 + A1:2010 + A12:2011.

Copy of marking plate

AOC
LCD monitor (LED Backlight)
Product Name: I2472PWHUT
Model No. : 236LM00018
Power Rating: 19V == 3.42A
AOC International **RoHS** Made in China Warning: Shock Hazard. Do Not Open.
Europe B.V. Amstelgebouw,
6th floor Prins Bernhardplein
200 1097 JB Amsterdam
The Netherlands
www.aoc.com
Q40G022N-615-31A

007
002
CAN ICES-3(B)/NMB-3(B)

Barcode: 55X14mm

AOC
LCD monitor (LED Backlight)
Product Name: I2272PWHUT
Model No. : 215LM00045
Power Rating: 19V == 3.42A
AOC International **RoHS** Made in China Warning: Shock Hazard. Do Not Open.
Europe B.V. Amstelgebouw,
6th floor Prins Bernhardplein
200 1097 JB Amsterdam
The Netherlands
www.aoc.com
Q40G022N-615-31A

007
002
CAN ICES-3(B)/NMB-3(B)

Barcode: 55X14mm

Note: The above label is a draft of an artwork of marking plate pending approval by National Certification Bodies and it shall not be affixed to products prior to such an approval.

| | |
|--|--|
| Test item particulars: | |
| Equipment mobility.....: | <input checked="" type="checkbox"/> movable <input type="checkbox"/> hand-held <input type="checkbox"/> transportable <input type="checkbox"/> stationary <input type="checkbox"/> for building-in <input type="checkbox"/> direct plug-in |
| Connection to the mains | <input type="checkbox"/> pluggable equipment <input type="checkbox"/> type A <input type="checkbox"/> type B <input type="checkbox"/> permanent connection <input type="checkbox"/> detachable power supply cord <input type="checkbox"/> non-detachable power supply cord <input checked="" type="checkbox"/> not directly connected to the mains |
| Operating condition.....: | <input checked="" type="checkbox"/> continuous <input type="checkbox"/> rated operating / resting time: |
| Access location | <input checked="" type="checkbox"/> operator accessible <input type="checkbox"/> restricted access location |
| Over voltage category (OVC) | <input type="checkbox"/> OVC I <input checked="" type="checkbox"/> OVC II <input type="checkbox"/> OVC III <input type="checkbox"/> OVC IV <input type="checkbox"/> other: |
| Mains supply tolerance (%) or absolute mains supply values | ±10% (requested by client) |
| Tested for IT power systems | <input type="checkbox"/> Yes <input checked="" type="checkbox"/> No |
| IT testing, phase-phase voltage (V) | N/A |
| Class of equipment | <input type="checkbox"/> Class I <input type="checkbox"/> Class II <input checked="" type="checkbox"/> Class III <input type="checkbox"/> Not classified |
| Considered current rating of protective device as part of the building installation (A) | 16A |
| Pollution degree (PD) | <input type="checkbox"/> PD 1 <input checked="" type="checkbox"/> PD 2 <input type="checkbox"/> PD 3 |
| IP protection class | IP20 |
| Altitude during operation (m) | ≤5000 |
| Altitude of test laboratory (m) | <2000 |
| Mass of equipment (kg) | For 21.5" model: 5.21kg (base weight 0.35kg); For 23.6" model: 5.30kg (base weight 0.35kg) |
| Possible test case verdicts: | |
| - test case does not apply to the test object | N/A |
| - test object does meet the requirement..... | P (Pass) |
| - test object does not meet the requirement..... | F (Fail) |
| Testing: | |
| Date of receipt of test item | Aug.2013 |
| Date(s) of performance of tests | Aug.2013 |
| General remarks: | |
| The test results presented in this report relate only to the object tested. This report shall not be reproduced, except in full, without the written approval of the Issuing testing laboratory. "(see Enclosure #)" refers to additional information appended to the report. "(see appended table)" refers to a table appended to the report. Throughout this report a <input type="checkbox"/> comma / <input checked="" type="checkbox"/> point is used as the decimal separator. | |

Manufacturer's Declaration per sub-clause 6.2.5 of IEC60950-1:

The application for obtaining a CB Test Certificate includes more than one factory location and a declaration from the Manufacturer stating that the sample(s) submitted for evaluation is (are) representative of the products from each factory has been provided

Yes
 Not applicable

When differences exist; they shall be identified in the General product information section.

Name and address of factory (ies).....:

- 1 TPV Technology (Beijing) Co., Ltd.
No.10, Jiu Xian Qiao Rd., Chao Yang District,
Beijing 100016 P.R. China
- 2 Tatung Mexico S.A. de. C.V.
Ave. Rosa Ma. Fuentes #7050 Complejo Industrial
Fuentes C.P. 32320, Cd. Juarez. Chih, MEXICO
- 3 TPV Display Technology (Wuhan) Co., Ltd.
Unique No. 11, Zhuankou Development District of
Economic Technological Development Zone,
Wuhan City 430056, P.R. China
- 4 TPV Electronics (Fujian) Co., Ltd.
Shangzheng, Yuan Hong Road, Fuqing City, Fujian
Province, P.R. China
- 5 Envision Industry of Electronic Products Ltd.
895, Joao Marcos Pozzetti Street, Industrial District
II, 69.075-215 Manaus, Am, Brazil
- 6 Tatung Czech s.r.o.
U Nove Hospody 4 30100 Plzen Czech Republic
- 7 Envision Industry of Electronic Products Ltd.
Rodovia Anhanguera S/N-KM 49, 13.205-700
Tijuco Preto-Jundiaí-SP-Brazil
- 8 TPV Displays Polska Sp. z o.o.
ul. Zlotego Smoka 9 66-400 Gorzów Wlkp. Poland
- 9 L&T Display Technology (Fujian) Ltd.
Optoelectronic Park, Rongqiao Economic and
Technological, Development Zone, Fuqing, Fujian
350301, P.R. China
- 10 Trend Smart CE Mexico S de RL de CV
Avenida Sor Juana Ines de la Cruz de 19602
Nueva Tijuana, 22435 Tijuans Baja California,
MEXICO
- 11 TPV Display Technology (Beihai) Co., Ltd.
China Electronic Beihai Industry Park, Northeast of
the Crossing Between Taiwan Road and Jilin
Road, Beihai City, Guangxi, P.R. China
- 12 Envision Industry of Electronic Products Ltd.
Av Torquato Tapajós 7503, Galpão : II Bloco: B –
Condomínio de Galpões – Tarumã - Manaus, AM,
Brazil
- 13 TPV Technology (Qingdao) Co., Ltd.
No.99 Huoju Road, High-tech Industrial
Development Zone, Qingdao City, Shandong
Province, P.R. China
- 14 TPV Display Technology (China) Co., Ltd.
No.106 Jinghai 3 Rd., BDA, Beijing City 100176,
P.R. China.

General product information:

The models mentioned in page 1 are LCD monitor intended for general office use.

Model 215LM000** is identical to model *2272***** except for type designation.

Model 236LM000** is identical to model *2472***** except for type designation.

Model 215LM000** has following features:

1. LCD Type: 21.5" TFT LCD with LED backlight;
2. External approved adapter used, which complies LPS and evaluated with altitude: 5000m;
3. Main board 715G6122 with VGA, HDMI, USB2.0, audio-in and audio-out ports, embedded with DC/DC converter circuit;
4. USB board 715G6205 with USB3.0 port and quickly charge USB port. The quickly charge USB port is able to charge power to other equipment, like cell phone;
5. The external plastic enclosure is regarded as decorative part;
6. Maximum declared ambient: 40°C.

Model 236LM000** is identical to model 215LM000** except for 23.6" TFT LCD panel used and bigger size of external plastic enclosure used.

Definition of variable(s):

| Variable: | Range of variable: | Content: |
|-----------|------------------------------------|--|
| * | 0-9, A-Z, a-z, -, \, /, + or blank | represent different enclosure colour for marketing purpose |
| | | |

Abbreviations used in the report:

| | | | |
|--------------------------------------|------|----------------------------|-------|
| - normal conditions | N.C. | - single fault conditions | S.F.C |
| - functional insulation | OP | - basic insulation | BI |
| - double insulation | DI | - supplementary insulation | SI |
| - between parts of opposite polarity | BOP | - reinforced insulation | RI |

Indicate used abbreviations (if any)

| IEC 60950-1 | | | |
|--------------------|--|---|------------|
| Clause | Requirement + Test | Result - Remark | Verdict |
| 1 | GENERAL | | P |
| 1.5 | Components | | P |
| 1.5.1 | General | | P |
| | Comply with IEC 60950 or relevant component standard | (see appended table 1.5.1) | P |
| 1.5.2 | Evaluation and testing of components | Components which are certified to IEC and/or national standards are used correctly within their ratings. Components not covered by IEC standards are tested under the conditions present in the equipment. | P |
| 1.5.3 | Thermal controls | No thermal controls. | N/A |
| 1.5.4 | Transformers | Considered in approved external adapters. | N/A |
| 1.5.5 | Interconnecting cables | Interconnecting cable does not carry voltage higher than SELV and no higher energy level than 240VA. | P |
| 1.5.6 | Capacitors bridging insulation | Considered in approved external adapter. | N/A |
| 1.5.7 | Resistors bridging insulation | Considered in approved external adapter. | N/A |
| 1.5.7.1 | Resistors bridging functional, basic or supplementary insulation | | N/A |
| 1.5.7.2 | Resistors bridging double or reinforced insulation between a.c. mains and other circuits | | N/A |
| 1.5.7.3 | Resistors bridging double or reinforced insulation between a.c. mains and antenna or coaxial cable | | N/A |
| 1.5.8 | Components in equipment for IT power systems | No such component. | N/A |
| 1.5.9 | Surge suppressors | No such component. | N/A |
| 1.5.9.1 | General | | N/A |
| 1.5.9.2 | Protection of VDRs | | N/A |
| 1.5.9.3 | Bridging of functional insulation by a VDR | | N/A |
| 1.5.9.4 | Bridging of basic insulation by a VDR | | N/A |
| 1.5.9.5 | Bridging of supplementary, double or reinforced insulation by a VDR | | N/A |
| 1.6 | Power interface | | P |

| IEC 60950-1 | | | |
|--------------------|--------------------------------------|---|------------|
| Clause | Requirement + Test | Result - Remark | Verdict |
| 1.6.1 | AC power distribution systems | Unit is not directly connected to the AC mains. | N/A |
| 1.6.2 | Input current | (see appended table 1.6.2) | P |
| 1.6.3 | Voltage limit of hand-held equipment | This appliance is not hand-held equipment. | N/A |
| 1.6.4 | Neutral conductor | | N/A |

| | | | |
|------------|--|--|------------|
| 1.7 | Marking and instructions | | P |
| 1.7.1 | Power rating and identification markings | See below. | P |
| 1.7.1.1 | Power rating marking | See below. | P |
| | Multiple mains supply connections.....: | | N/A |
| | Rated voltage(s) or voltage range(s) (V) | See copy of marking plate for details | P |
| | Symbol for nature of supply, for d.c. only.....: | See copy of marking plate for details | P |
| | Rated frequency or rated frequency range (Hz) ...: | | N/A |
| | Rated current (mA or A) | See copy of marking plate for details | P |
| 1.7.1.2 | Identification markings | See below. | P |
| | Manufacturer's name or trade-mark or identification mark | See copy of marking plate for details | P |
| | Model identification or type reference | See copy of marking plate for details | P |
| | Symbol for Class II equipment only | Class III equipment. | N/A |
| | Other markings and symbols | Additional symbol or marking does not give rise to misunderstanding. | P |
| 1.7.2 | Safety instructions and marking | English safety instruction provided. | P |
| 1.7.2.1 | General | | P |
| 1.7.2.2 | Disconnect devices | | N/A |
| 1.7.2.3 | Overcurrent protective device | | N/A |
| 1.7.2.4 | IT power distribution systems | | N/A |
| 1.7.2.5 | Operator access with a tool | No such access required. | N/A |
| 1.7.2.6 | Ozone | Ozone not used or generated. | N/A |
| 1.7.3 | Short duty cycles | Equipment is designed for continuous operation. | N/A |
| 1.7.4 | Supply voltage adjustment | | N/A |

| IEC 60950-1 | | | |
|--------------------|--|---|------------|
| Clause | Requirement + Test | Result - Remark | Verdict |
| | Methods and means of adjustment; reference to installation instructions | | N/A |
| 1.7.5 | Power outlets on the equipment | No power outlets provided. | N/A |
| 1.7.6 | Fuse identification (marking, special fusing characteristics, cross-reference) | Considered in approved external adapter. | N/A |
| 1.7.7 | Wiring terminals | See below. | N/A |
| 1.7.7.1 | Protective earthing and bonding terminals | No earthing terminals and bonding terminals | N/A |
| 1.7.7.2 | Terminals for a.c. mains supply conductors | Not connected to a.c. mains | N/A |
| 1.7.7.3 | Terminals for d.c. mains supply conductors | Not connected to d.c. mains | N/A |
| 1.7.8 | Controls and indicators | See below | P |
| 1.7.8.1 | Identification, location and marking | "STAND-BY" condition is indicated by the symbol according to 60417-1-IEC-5009. | P |
| 1.7.8.2 | Colours | Colours used for LED indicate the operation status and not involved safety. | N/A |
| 1.7.8.3 | Symbols according to IEC 60417..... | See 1.7.8.1 | P |
| 1.7.8.4 | Markings using figures | No figures used. | N/A |
| 1.7.9 | Isolation of multiple power sources | Only one supply voltage range provided. | N/A |
| 1.7.10 | Thermostats and other regulating devices | No such components. | N/A |
| 1.7.11 | Durability | The label was subjected to the permanence of marking test. The label was rubbed with cloth soaked with water for 15 sec. and then again for 15 sec. with the cloth soaked with petroleum spirit. After this test there was no damage to the label. The marking on the label did not fade. There was no curling or lifting of the label edge. | P |
| 1.7.12 | Removable parts | None. | N/A |
| 1.7.13 | Replaceable batteries | No batteries. | N/A |
| | Language(s) | | — |
| 1.7.14 | Equipment for restricted access locations | Equipment not intended for installation in restricted access locations. | N/A |
| 2 | PROTECTION FROM HAZARDS | | P |

| IEC 60950-1 | | | |
|--------------------|--|--|------------|
| Clause | Requirement + Test | Result - Remark | Verdict |
| 2.1 | Protection from electric shock and energy hazards | | P |
| 2.1.1 | Protection in operator access areas | Only SELV signal interface accessible by operator. | P |
| 2.1.1.1 | Access to energized parts | No hazardous voltage inside, class III product | P |
| | Test by inspection | | N/A |
| | Test with test finger (Figure 2A) | | N/A |
| | Test with test pin (Figure 2B) | | N/A |
| | Test with test probe (Figure 2C) | | N/A |
| 2.1.1.2 | Battery compartments | No battery compartment. | N/A |
| 2.1.1.3 | Access to ELV wiring | No ELV wiring in operator accessible area. | N/A |
| | Working voltage (V _{peak} or V _{rms}); minimum distance through insulation (mm) | | — |
| 2.1.1.4 | Access to hazardous voltage circuit wiring | No hazardous voltage wiring in operator accessible area. | N/A |
| 2.1.1.5 | Energy hazards | Supplied by SELV having a energy level less than 240VA | P |
| 2.1.1.6 | Manual controls | No manual controls. | N/A |
| 2.1.1.7 | Discharge of capacitors in equipment | Considered in approved external adapter. | N/A |
| | Measured voltage (V); time-constant (s)..... | | — |
| 2.1.1.8 | Energy hazards – d.c. mains supply | | N/A |
| | a) Capacitor connected to the d.c. mains supply .. | | N/A |
| | b) Internal battery connected to the d.c. mains supply | | N/A |
| 2.1.1.9 | Audio amplifiers | | N/A |
| 2.1.2 | Protection in service access areas | No service access area. | N/A |
| 2.1.3 | Protection in restricted access locations | Equipment not intended for installation in restricted access locations | N/A |
| 2.2 | SELV circuits | | P |
| 2.2.1 | General requirements | See below | P |
| 2.2.2 | Voltages under normal conditions (V) | 42.4V peak or 60V d.c. are not exceeded in SELV circuit under normal operation. (See appended table 2.2.2) | P |

| IEC 60950-1 | | | |
|-------------|---|--|----------|
| Clause | Requirement + Test | Result - Remark | Verdict |
| 2.2.3 | Voltages under fault conditions (V) | Single fault did not cause excessive voltage in accessible SELV circuits. Limits of 71V peak and 120V d.c. were not exceeded within 0.2 sec. and limits 42.4V peak and 60V d.c. were not exceeded for longer than 0.2 sec., see appended tables 2.2.3 and 5.3. | P |
| 2.2.4 | Connection of SELV circuits to other circuits | Connect to SELV circuit | P |

| | | | |
|------------|--|--|------------|
| 2.3 | TNV circuits <i>No TNV circuits, requirements not applicable to the evaluated product.</i> | | N/A |
| 2.3.1 | Limits | | N/A |
| | Type of TNV circuits..... | | — |
| 2.3.2 | Separation from other circuits and from accessible parts | | N/A |
| 2.3.2.1 | General requirements | | N/A |
| 2.3.2.2 | Protection by basic insulation | | N/A |
| 2.3.2.3 | Protection by earthing | | N/A |
| 2.3.2.4 | Protection by other constructions | | N/A |
| 2.3.3 | Separation from hazardous voltages | | N/A |
| | Insulation employed | | — |
| 2.3.4 | Connection of TNV circuits to other circuits | | N/A |
| | Insulation employed | | — |
| 2.3.5 | Test for operating voltages generated externally | | N/A |

| | | | |
|------------|--|--|------------|
| 2.4 | Limited current circuits <i>No limited current circuits, requirements not applicable to the evaluated product.</i> | | N/A |
| 2.4.1 | General requirements | | N/A |
| 2.4.2 | Limit values | | N/A |
| | Frequency (H2) | | — |
| | Measured current (mA) | | — |
| | Measured voltage (V) | | — |
| | Measured circuit capacitance (nF or μ F) | | — |
| 2.4.3 | Connection of limited current circuits to other circuits | | N/A |

| | | | |
|------------|------------------------------|--|----------|
| 2.5 | Limited power sources | | P |
|------------|------------------------------|--|----------|

| IEC 60950-1 | | | |
|-------------|--|-----------------|---------|
| Clause | Requirement + Test | Result - Remark | Verdict |
| | <i>Requirement not applicable to the evaluated product.</i> | | |
| | a) Inherently limited output | | N/A |
| | b) Impedance limited output | | N/A |
| | c) Regulating network limited output under normal operating and single fault condition | | N/A |
| | d) Overcurrent protective device limited output | | N/A |
| | Max. output voltage (V), max. output current (A), max. apparent power (VA) | | — |
| | Current rating of overcurrent protective device (A) | | — |
| | Use of integrated circuit (IC) current limiters | | |

| | | | |
|------------|--|--|------------|
| 2.6 | Provisions for earthing and bonding <i>Class III equipment.</i> | | N/A |
| 2.6.1 | Protective earthing | | N/A |
| 2.6.2 | Functional earthing | | N/A |
| 2.6.3 | Protective earthing and protective bonding conductors | | N/A |
| 2.6.3.1 | General | | N/A |
| 2.6.3.2 | Size of protective earthing conductors | | N/A |
| | Rated current (A), cross-sectional area (mm ²), AWG | | — |
| 2.6.3.3 | Size of protective bonding conductors | | N/A |
| | Rated current (A), cross-sectional area (mm ²), AWG | | — |
| | Protective current rating (A), cross-sectional area (mm ²), AWG | | |
| 2.6.3.4 | Resistance of earthing conductors and their terminations; resistance (Ω), voltage drop (V), test current (A), duration (min)..... | | N/A |
| 2.6.3.5 | Colour of insulation | | N/A |
| 2.6.4 | Terminals | | N/A |
| 2.6.4.1 | General | | N/A |
| 2.6.4.2 | Protective earthing and bonding terminals | | N/A |
| | Rated current (A), type, nominal thread diameter (mm)..... | | — |
| 2.6.4.3 | Separation of the protective earthing conductor from protective bonding conductors | | N/A |
| 2.6.5 | Integrity of protective earthing | | N/A |
| 2.6.5.1 | Interconnection of equipment | | N/A |
| 2.6.5.2 | Components in protective earthing conductors and protective bonding conductors | | N/A |

| IEC 60950-1 | | | |
|-------------|---|---------------------------------|----------|
| Clause | Requirement + Test | Result - Remark | Verdict |
| 2.6.5.3 | Disconnection of protective earth | | N/A |
| 2.6.5.4 | Parts that can be removed by an operator | | N/A |
| 2.6.5.5 | Parts removed during servicing | | N/A |
| 2.6.5.6 | Corrosion resistance | | N/A |
| 2.6.5.7 | Screws for protective bonding | | N/A |
| 2.6.5.8 | Reliance on telecommunication network or cable distribution system | | N/A |
| 2.7 | Overcurrent and earth fault protection in primary circuits <i>No primary circuit, requirement not applicable to the evaluated product</i> | | N/A |
| 2.7.1 | Basic requirements | | N/A |
| | Instructions when protection relies on building installation | | N/A |
| 2.7.2 | Faults not simulated in 5.3.7 | | N/A |
| 2.7.3 | Short-circuit backup protection | | N/A |
| 2.7.4 | Number and location of protective devices : | | N/A |
| 2.7.5 | Protection by several devices | | N/A |
| 2.7.6 | Warning to service personnel : | | N/A |
| 2.8 | Safety interlocks | | N/A |
| 2.8.1 | General principles | | N/A |
| 2.8.2 | Protection requirements | | N/A |
| 2.8.3 | Inadvertent reactivation | | N/A |
| 2.8.4 | Fail-safe operation | | N/A |
| | Protection against extreme hazard | | N/A |
| 2.8.5 | Moving parts | | N/A |
| 2.8.6 | Overriding | | N/A |
| 2.8.7 | Switches and relays | | N/A |
| 2.8.7.1 | Contact gaps (mm) : | | N/A |
| 2.8.7.2 | Overload test | | N/A |
| 2.8.7.3 | Endurance test | | N/A |
| 2.8.7.4 | Electric strength test | | N/A |
| 2.8.8 | Mechanical actuators | | N/A |
| 2.9 | Electrical insulation | | P |
| 2.9.1 | Properties of insulating materials | Function insulation Considered. | P |

| IEC 60950-1 | | | |
|-------------|---|---------------------------------|---------|
| Clause | Requirement + Test | Result - Remark | Verdict |
| 2.9.2 | Humidity conditioning | | N/A |
| | Relative humidity (%), temperature (°C) | | — |
| 2.9.3 | Grade of insulation | Function insulation Considered. | P |
| 2.9.4 | Separation from hazardous voltages | | N/A |
| | Method(s) used | | — |

| | | | |
|-------------|---|--|------------|
| 2.10 | Clearances, creepage distances and distances through insulation <i>Supplied by SELV, and functional insulation inside the unit, requirements not applicable, see clause 5.3.4</i> | | N/A |
| 2.10.1 | General | | N/A |
| 2.10.1.1 | Frequency | | N/A |
| 2.10.1.2 | Pollution degrees | | N/A |
| 2.10.1.3 | Reduced values for functional insulation | | N/A |
| 2.10.1.4 | Intervening unconnected conductive parts | | N/A |
| 2.10.1.5 | Insulation with varying dimensions | | N/A |
| 2.10.1.6 | Special separation requirements | | N/A |
| 2.10.1.7 | Insulation in circuits generating starting pulses | | N/A |
| 2.10.2 | Determination of working voltage | | N/A |
| 2.10.2.1 | General | | N/A |
| 2.10.2.2 | RMS working voltage | | N/A |
| 2.10.2.3 | Peak working voltage | | N/A |
| 2.10.3 | Clearances | | N/A |
| 2.10.3.1 | General | | N/A |
| 2.10.3.2 | Mains transient voltages | | N/A |
| | a) AC mains supply | | N/A |
| | b) Earthed d.c. mains supplies | | N/A |
| | c) Unearthed d.c. mains supplies | | N/A |
| | d) Battery operation | | N/A |
| 2.10.3.3 | Clearances in primary circuits | | N/A |
| 2.10.3.4 | Clearances in secondary circuits | | N/A |
| 2.10.3.5 | Clearances in circuits having starting pulses | | N/A |
| 2.10.3.6 | Transients from a.c. mains supply | | N/A |
| 2.10.3.7 | Transients from d.c. mains supply | | N/A |
| 2.10.3.8 | Transients from telecommunication networks and cable distribution systems | | N/A |
| 2.10.3.9 | Measurement of transient voltage levels | | N/A |

| IEC 60950-1 | | | |
|--------------------|---|-----------------|------------|
| Clause | Requirement + Test | Result - Remark | Verdict |
| | a) Transients from a mains supply | | N/A |
| | For an a.c. mains supply | | N/A |
| | For a d.c. mains supply | | N/A |
| | b) Transients from a telecommunication network : | | N/A |
| 2.10.4 | Creepage distances | | N/A |
| 2.10.4.1 | General | | N/A |
| 2.10.4.2 | Material group and comparative tracking index | | N/A |
| | CTI tests | | — |
| 2.10.4.3 | Minimum creepage distances | | N/A |
| 2.10.5 | Solid insulation | | N/A |
| 2.10.5.1 | General | | N/A |
| 2.10.5.2 | Distances through insulation | | N/A |
| 2.10.5.3 | Insulating compound as solid insulation | | N/A |
| 2.10.5.4 | Semiconductor devices | | N/A |
| 2.10.5.5. | Cemented joints | | N/A |
| 2.10.5.6 | Thin sheet material – General | | N/A |
| 2.10.5.7 | Separable thin sheet material | | N/A |
| | Number of layers (pcs) | | — |
| 2.10.5.8 | Non-separable thin sheet material | | N/A |
| 2.10.5.9 | Thin sheet material – standard test procedure | | N/A |
| | Electric strength test | | — |
| 2.10.5.10 | Thin sheet material – alternative test procedure | | N/A |
| | Electric strength test | | — |
| 2.10.5.11 | Insulation in wound components | | N/A |
| 2.10.5.12 | Wire in wound components | | N/A |
| | Working voltage | | N/A |
| | a) Basic insulation not under stress | | N/A |
| | b) Basic, supplementary, reinforced insulation | | N/A |
| | c) Compliance with Annex U | | N/A |
| | Two wires in contact inside wound component; angle between 45° and 90° | | N/A |
| 2.10.5.13 | Wire with solvent-based enamel in wound components | | N/A |
| | Electric strength test | | — |
| | Routine test | | N/A |
| 2.10.5.14 | Additional insulation in wound components | | N/A |
| | Working voltage | | N/A |

| IEC 60950-1 | | | |
|-------------|--|-----------------|---------|
| Clause | Requirement + Test | Result - Remark | Verdict |
| | - Basic insulation not under stress | | N/A |
| | - Supplementary, reinforced insulation | | N/A |
| 2.10.6 | Construction of printed boards | | N/A |
| 2.10.6.1 | Uncoated printed boards | | N/A |
| 2.10.6.2 | Coated printed boards | | N/A |
| 2.10.6.3 | Insulation between conductors on the same inner surface of a printed board | | N/A |
| 2.10.6.4 | Insulation between conductors on different layers of a printed board | | N/A |
| | Distance through insulation | | N/A |
| | Number of insulation layers (pcs)..... | | N/A |
| 2.10.7 | Component external terminations | | N/A |
| 2.10.8 | Tests on coated printed boards and coated components | | N/A |
| 2.10.8.1 | Sample preparation and preliminary inspection | | N/A |
| 2.10.8.2 | Thermal conditioning | | N/A |
| 2.10.8.3 | Electric strength test | | N/A |
| 2.10.8.4 | Abrasion resistance test | | N/A |
| 2.10.9 | Thermal cycling | | N/A |
| 2.10.10 | Test for Pollution Degree 1 environment and insulating compound | | N/A |
| 2.10.11 | Tests for semiconductor devices and cemented joints | | N/A |
| 2.10.12 | Enclosed and sealed parts | | N/A |

| | | | |
|----------|---|--|----------|
| 3 | WIRING, CONNECTIONS AND SUPPLY | | P |
| 3.1 | General | | P |
| 3.1.1 | Current rating and overcurrent protection | The internal wires have suitable size to carry rated current | P |
| 3.1.2 | Protection against mechanical damage | Wires do not touch sharp edges which could damage the insulation and cause hazard. | P |
| 3.1.3 | Securing of internal wiring | Wires are secured by soldering method and additionally fixed by glue or by connectors. | P |

| IEC 60950-1 | | | |
|--------------------|--|--|------------|
| Clause | Requirement + Test | Result - Remark | Verdict |
| 3.1.4 | Insulation of conductors | The insulation of the individual conductors suitable for the application and the working voltage. For the insulation material see 3.1.1. | P |
| 3.1.5 | Beads and ceramic insulators | Not used. | N/A |
| 3.1.6 | Screws for electrical contact pressure | | N/A |
| 3.1.7 | Insulating materials in electrical connections | | N/A |
| 3.1.8 | Self-tapping and spaced thread screws | No self-tapping screws are used. | N/A |
| 3.1.9 | Termination of conductors | | N/A |
| | 10 N pull test | | N/A |
| 3.1.10 | Sleeving on wiring | | N/A |
| 3.2 | Connection to a mains supply <i>No direct connection to mains. Requirements not applicable to the evaluated product.</i> | | N/A |
| 3.2.1 | Means of connection | | N/A |
| 3.2.1.1 | Connection to an a.c. mains supply | | N/A |
| 3.2.1.2 | Connection to a d.c. mains supply | | N/A |
| 3.2.2 | Multiple supply connections | | N/A |
| 3.2.3 | Permanently connected equipment | | N/A |
| | Number of conductors, diameter of cable and conduits (mm) | | — |
| 3.2.4 | Appliance inlets | | N/A |
| 3.2.5 | Power supply cords | | N/A |
| 3.2.5.1 | AC power supply cords | | N/A |
| | Type | | — |
| | Rated current (A), cross-sectional area (mm ²), AWG | | — |
| 3.2.5.2 | DC power supply cords | | N/A |
| 3.2.6 | Cord anchorages and strain relief | | N/A |
| | Mass of equipment (kg), pull (N) | | — |
| | Longitudinal displacement (mm) | | — |
| 3.2.7 | Protection against mechanical damage | | N/A |
| 3.2.8 | Cord guards | | N/A |
| | Diameter or minor dimension D (mm); test mass (g) | | — |

| IEC 60950-1 | | | |
|-------------|--|--|------------|
| Clause | Requirement + Test | Result - Remark | Verdict |
| | Radius of curvature of cord (mm)..... : | | — |
| 3.2.9 | Supply wiring space | | N/A |
| 3.3 | Wiring terminals for connection of external conductors <i>No direct connection to mains. Requirements not applicable to the evaluated product.</i> | | N/A |
| 3.3.1 | Wiring terminals | | N/A |
| 3.3.2 | Connection of non-detachable power supply cords | | N/A |
| 3.3.3 | Screw terminals | | N/A |
| 3.3.4 | Conductor sizes to be connected | | N/A |
| | Rated current (A), cord/cable type, cross-sectional area (mm ²)..... : | | — |
| 3.3.5 | Wiring terminal sizes | | N/A |
| | Rated current (A), type, nominal thread diameter (mm) | | — |
| 3.3.6 | Wiring terminal design | | N/A |
| 3.3.7 | Grouping of wiring terminals | | N/A |
| 3.3.8 | Stranded wire | | N/A |
| 3.4 | Disconnection from the mains supply <i>No direct connection to mains. Requirements not applicable to the evaluated product.</i> | | N/A |
| 3.4.1 | General requirement | | N/A |
| 3.4.2 | Disconnect devices | | N/A |
| 3.4.3 | Permanently connected equipment | | N/A |
| 3.4.4 | Parts which remain energized | | N/A |
| 3.4.5 | Switches in flexible cords | | N/A |
| 3.4.6 | Number of poles - single-phase and d.c. equipment | | N/A |
| 3.4.7 | Number of poles - three-phase equipment | | N/A |
| 3.4.8 | Switches as disconnect devices | | N/A |
| 3.4.9 | Plugs as disconnect devices | | N/A |
| 3.4.10 | Interconnected equipment | | N/A |
| 3.4.11 | Multiple power sources | | N/A |
| 3.5 | Interconnection of equipment | | P |
| 3.5.1 | General requirements | This power supply is not considered for connection to TNV. | P |

| IEC 60950-1 | | | |
|-------------|--|--|------------|
| Clause | Requirement + Test | Result - Remark | Verdict |
| 3.5.2 | Types of interconnection circuits | Interconnection circuits of SELV through the connector. No ELV interconnection circuits. | P |
| 3.5.3 | ELV circuits as interconnection circuits | No ELV interconnection | N/A |
| 3.5.4 | Data ports for additional equipment | All data ports are supplied by LPS. | P |

| | | | |
|----------|------------------------------|---|------------|
| 4 | PHYSICAL REQUIREMENTS | | P |
| 4.1 | Stability | | N/A |
| | Angle of 10° | Mass<7kg | N/A |
| | Test force (N) | Equipment is not a floor standing unit. | N/A |

| | | | |
|------------|---|--|------------|
| 4.2 | Mechanical strength <i>Evaluated product supplied by SELV and all the circuits inside the enclosure are SELV circuits</i> | | N/A |
| 4.2.1 | General | | N/A |
| | Rack-mounted equipment. | | N/A |
| 4.2.2 | Steady force test, 10 N | | N/A |
| 4.2.3 | Steady force test, 30 N | | N/A |
| 4.2.4 | Steady force test, 250 N | | N/A |
| 4.2.5 | Impact test | | N/A |
| | Fall test | | N/A |
| | Swing test | | N/A |
| 4.2.6 | Drop test; height (mm) | | N/A |
| 4.2.7 | Stress relief test | | N/A |
| 4.2.8 | Cathode ray tubes | | N/A |
| | Picture tube separately certified | | N/A |
| 4.2.9 | High pressure lamps | | N/A |
| 4.2.10 | Wall or ceiling mounted equipment; force (N) | | N/A |

| | | | |
|------------|--|---|------------|
| 4.3 | Design and construction | | P |
| 4.3.1 | Edges and corners | Edges and corners of the enclosure are rounded. | P |
| 4.3.2 | Handles and manual controls; force (N) | No safety relevant handles or manual controls. | N/A |
| 4.3.3 | Adjustable controls | No such controls. | N/A |
| 4.3.4 | Securing of parts | | N/A |

| IEC 60950-1 | | | |
|--------------------|---|--|------------|
| Clause | Requirement + Test | Result - Remark | Verdict |
| 4.3.5 | Connection by plugs and sockets | | N/A |
| 4.3.6 | Direct plug-in equipment | Not such equipment. | N/A |
| | Torque | | — |
| | Compliance with the relevant mains plug standard | | N/A |
| 4.3.7 | Heating elements in earthed equipment | None. | N/A |
| 4.3.8 | Batteries | No batteries. | N/A |
| | - Overcharging of a rechargeable battery | | N/A |
| | - Unintentional charging of a non-rechargeable battery | | N/A |
| | - Reverse charging of a rechargeable battery | | N/A |
| | - Excessive discharging rate for any battery | | N/A |
| 4.3.9 | Oil and grease | None. | N/A |
| 4.3.10 | Dust, powders, liquids and gases | Equipment in intended use not considered to be exposed to these. | N/A |
| 4.3.11 | Containers for liquids or gases | None | N/A |
| 4.3.12 | Flammable liquids | None | N/A |
| | Quantity of liquid (l) | | N/A |
| | Flash point (°C) | | N/A |
| 4.3.13 | Radiation | | P |
| 4.3.13.1 | General | See below | P |
| 4.3.13.2 | Ionizing radiation | No ionizing radiation. | N/A |
| | Measured radiation (pA/kg) | | — |
| | Measured high-voltage (kV) | | — |
| | Measured focus voltage (kV) | | — |
| | CRT markings | | — |
| 4.3.13.3 | Effect of ultraviolet (UV) radiation on materials | No ultraviolet radiation | N/A |
| | Part, property, retention after test, flammability classification | | N/A |
| 4.3.13.4 | Human exposure to ultraviolet (UV) radiation | No ultraviolet radiation | N/A |
| 4.3.13.5 | Lasers (including laser diodes) and LEDs | See below. | P |
| 4.3.13.5.1 | Lasers (including laser diodes) | Not used. | N/A |
| | Laser class | | — |
| 4.3.13.5.2 | Light emitting diodes (LEDs) | Indicating LED on secondary is inherently Class1 according to IEC 60825-1. | P |
| 4.3.13.6 | Other types | | N/A |

| IEC 60950-1 | | | |
|-------------|--|---|------------|
| Clause | Requirement + Test | Result - Remark | Verdict |
| 4.4 | Protection against hazardous moving parts | | N/A |
| 4.4.1 | General | | N/A |
| 4.4.2 | Protection in operator access areas | | N/A |
| | Household and home/office document/media shredders | | N/A |
| 4.4.3 | Protection in restricted access locations | | N/A |
| 4.4.4 | Protection in service access areas | | N/A |
| 4.4.5 | Protection against moving fan blades | | N/A |
| 4.4.5.1 | General | | N/A |
| | Not considered to cause pain or injury. a).....: | | N/A |
| | Is considered to cause pain, not injury. b) | | N/A |
| | Considered to cause injury. c) | | N/A |
| 4.4.5.2 | Protection for users | | N/A |
| | Use of symbol or warning | | N/A |
| 4.4.5.3 | Protection for service persons | | N/A |
| | Use of symbol or warning | | N/A |
| 4.5 | Thermal requirements | | P |
| 4.5.1 | General | | P |
| 4.5.2 | Temperature tests | | P |
| | Normal load condition per Annex L | Equipment loaded with rated output current. | — |
| 4.5.3 | Temperature limits for materials | (see appended table 4.5) | P |
| 4.5.4 | Touch temperature limits | (see appended table 4.5) | P |
| 4.5.5 | Resistance to abnormal heat | | N/A |
| 4.6 | Openings in enclosures | | N/A |
| 4.6.1 | Top and side openings | | N/A |
| | Dimensions (mm) | | — |
| 4.6.2 | Bottoms of fire enclosures | | N/A |
| | Construction of the bottom, dimensions (mm) ..: | | — |
| 4.6.3 | Doors or covers in fire enclosures | | N/A |
| 4.6.4 | Openings in transportable equipment | | N/A |
| 4.6.4.1 | Constructional design measures | | N/A |
| | Dimensions (mm) | | — |
| 4.6.4.2 | Evaluation measures for larger openings | | N/A |
| 4.6.4.3 | Use of metallized parts | | N/A |

| IEC 60950-1 | | | |
|-------------|--|-----------------|---------|
| Clause | Requirement + Test | Result - Remark | Verdict |
| 4.6.5 | Adhesives for constructional purposes | | N/A |
| | Conditioning temperature (°C), time (weeks)..... : | | — |

| | | | |
|------------|--|--|------------|
| 4.7 | Resistance to fire | | P |
| 4.7.1 | Reducing the risk of ignition and spread of flame | No excessive temperatures. No easily burning materials employed. Fire enclosure provided. Safety relevant components used within their specified temperature limits. | P |
| | Method 1, selection and application of components wiring and materials | | P |
| | Method 2, application of all of simulated fault condition tests | | N/A |
| 4.7.2 | Conditions for a fire enclosure | The unit is powered by LPS from approved external adapters, and internal parts/components mounted on V-1 or better PCB. | P |
| 4.7.2.1 | Parts requiring a fire enclosure | | N/A |
| 4.7.2.2 | Parts not requiring a fire enclosure | For components supplied by LPS and mounted on V-1 or better material PCB. | P |
| 4.7.3 | Materials | | P |
| 4.7.3.1 | General | PCB rated V-1 or better. | P |
| 4.7.3.2 | Materials for fire enclosures | | N/A |
| 4.7.3.3 | Materials for components and other parts outside fire enclosures | | N/A |
| 4.7.3.4 | Materials for components and other parts inside fire enclosures | | N/A |
| 4.7.3.5 | Materials for air filter assemblies | No air filter. | N/A |
| 4.7.3.6 | Materials used in high-voltage components | No such high voltage components in this meaning | N/A |

| | | | |
|----------|---|--|------------|
| 5 | ELECTRICAL REQUIREMENTS AND SIMULATED ABNORMAL CONDITIONS | | P |
| 5.1 | Touch current and protective conductor current <i>Class III product, requirements not applicable to the evaluated product.</i> | | N/A |
| 5.1.1 | General | | N/A |
| 5.1.2 | Configuration of equipment under test (EUT) | | N/A |
| 5.1.2.1 | Single connection to an a.c. mains supply | | N/A |
| 5.1.2.2 | Redundant multiple connections to an a.c. mains supply | | N/A |

| IEC 60950-1 | | | |
|-------------|---|---|----------|
| Clause | Requirement + Test | Result - Remark | Verdict |
| 5.1.2.3 | Simultaneous multiple connections to an a.c. mains supply | | N/A |
| 5.1.3 | Test circuit | | N/A |
| 5.1.4 | Application of measuring instrument | | N/A |
| 5.1.5 | Test procedure | | N/A |
| 5.1.6 | Test measurements | | N/A |
| | Supply voltage (V) | | — |
| | Measured touch current (mA) | | — |
| | Max. allowed touch current (mA) | | — |
| | Measured protective conductor current (mA) | | — |
| | Max. allowed protective conductor current (mA).... | | — |
| 5.1.7 | Equipment with touch current exceeding 3,5 mA | | N/A |
| 5.1.7.1 | General | | N/A |
| 5.1.7.2 | Simultaneous multiple connections to the supply | | N/A |
| 5.1.8 | Touch currents to telecommunication networks and cable distribution systems and from telecommunication networks | | N/A |
| 5.1.8.1 | Limitation of the touch current to a telecommunication network or to a cable distribution system | | N/A |
| | Supply voltage (V) | | — |
| | Measured touch current (mA) | | — |
| | Max. allowed touch current (mA) | | — |
| 5.1.8.2 | Summation of touch currents from telecommunication networks | | N/A |
| | a) EUT with earthed telecommunication ports | | N/A |
| | b) EUT whose telecommunication ports have no reference to protective earth | | N/A |
| 5.2 | Electric strength <i>Class III product, requirements not applicable to the evaluated product.</i> | | N/A |
| 5.2.1 | General | | N/A |
| 5.2.2 | Test procedure | | N/A |
| 5.3 | Abnormal operating and fault conditions | | P |
| 5.3.1 | Protection against overload and abnormal operation | (see appended table 5.3) | P |
| 5.3.2 | Motors | Motors not used. | N/A |
| 5.3.3 | Transformers | Considered in approved external adapters. | N/A |

| IEC 60950-1 | | | |
|--------------------|---|--|------------|
| Clause | Requirement + Test | Result - Remark | Verdict |
| 5.3.4 | Functional insulation..... : | By short-circuited, results see appended table 5.3. | P |
| 5.3.5 | Electromechanical components | No electromechanical component. | N/A |
| 5.3.6 | Audio amplifiers in ITE : | | N/A |
| 5.3.7 | Simulation of faults | (see appended table 5.3.) | P |
| 5.3.8 | Unattended equipment | No such equipment. | N/A |
| 5.3.9 | Compliance criteria for abnormal operating and fault conditions | | P |
| 5.3.9.1 | During the tests | No fire or molten metal occurred and no deformation of enclosure during the tests. | P |
| 5.3.9.2 | After the tests | | N/A |
| 6 | CONNECTION TO TELECOMMUNICATION NETWORKS | | N/A |
| 6.1 | Protection of telecommunication network service persons, and users of other equipment connected to the network, from hazards in the equipment | | N/A |
| 6.1.1 | Protection from hazardous voltages | | N/A |
| 6.1.2 | Separation of the telecommunication network from earth | | N/A |
| 6.1.2.1 | Requirements | | N/A |
| | Supply voltage (V) : | | — |
| | Current in the test circuit (mA) : | | — |
| 6.1.2.2 | Exclusions : | | |
| 6.2 | Protection of equipment users from overvoltages on telecommunication networks | | N/A |
| 6.2.1 | Separation requirements | | N/A |
| 6.2.2 | Electric strength test procedure | | N/A |
| 6.2.2.1 | Impulse test | | N/A |
| 6.2.2.2 | Steady-state test | | N/A |
| 6.2.2.3 | Compliance criteria | | N/A |
| 6.3 | Protection of the telecommunication wiring system from overheating | | N/A |
| | Max. output current (A) : | | — |
| | Current limiting method : | | — |
| 7 | CONNECTION TO CABLE DISTRIBUTION SYSTEMS | | N/A |
| 7.1 | General | | N/A |

| IEC 60950-1 | | | |
|--------------------|---|-----------------|------------|
| Clause | Requirement + Test | Result - Remark | Verdict |
| 7.2 | Protection of cable distribution system service persons, and users of other equipment connected to the system, from hazardous voltages in the equipment | | N/A |
| 7.3 | Protection of equipment users from overvoltages on the cable distribution system | | N/A |
| 7.4 | Insulation between primary circuits and cable distribution systems | | N/A |
| 7.4.1 | General | | N/A |
| 7.4.2 | Voltage surge test | | N/A |
| 7.4.3 | Impulse test | | N/A |

| | | | |
|----------|--|--|------------|
| A | ANNEX A, TESTS FOR RESISTANCE TO HEAT AND FIRE | | N/A |
| A.1 | Flammability test for fire enclosures of movable equipment having a total mass exceeding 18 kg, and of stationary equipment (see 4.7.3.2) | | N/A |
| A.1.1 | Samples | | — |
| | Wall thickness (mm) | | — |
| A.1.2 | Conditioning of samples; temperature (°C) | | N/A |
| A.1.3 | Mounting of samples | | N/A |
| A.1.4 | Test flame (see IEC 60695-11-3) | | N/A |
| | Flame A, B, C or D | | — |
| A.1.5 | Test procedure | | N/A |
| A.1.6 | Compliance criteria | | N/A |
| | Sample 1 burning time (s) | | — |
| | Sample 2 burning time (s) | | — |
| | Sample 3 burning time (s) | | — |
| A.2 | Flammability test for fire enclosures of movable equipment having a total mass not exceeding 18 kg, and for material and components located inside fire enclosures (see 4.7.3.2 and 4.7.3.4) | | N/A |
| A.2.1 | Samples, material | | — |
| | Wall thickness (mm) | | — |
| A.2.2 | Conditioning of samples; temperature (°C) | | N/A |
| A.2.3 | Mounting of samples | | N/A |
| A.2.4 | Test flame (see IEC 60695-11-4) | | N/A |
| | Flame A, B or C | | — |
| A.2.5 | Test procedure | | N/A |
| A.2.6 | Compliance criteria | | N/A |
| | Sample 1 burning time (s) | | — |

| IEC 60950-1 | | | |
|--------------------|--|-----------------|------------|
| Clause | Requirement + Test | Result - Remark | Verdict |
| | Sample 2 burning time (s) | | — |
| | Sample 3 burning time (s) | | — |
| A.2.7 | Alternative test acc. to IEC 60695-11-5, cl. 5 and 9 | | N/A |
| | Sample 1 burning time (s) | | — |
| | Sample 2 burning time (s) | | — |
| | Sample 3 burning time (s) | | — |
| A.3 | Hot flaming oil test (see 4.6.2) | | N/A |
| A.3.1 | Mounting of samples | | N/A |
| A.3.2 | Test procedure | | N/A |
| A.3.3 | Compliance criterion | | N/A |

| | | | |
|----------|---|--|------------|
| B | ANNEX B, MOTOR TESTS UNDER ABNORMAL CONDITIONS (see 4.7.2.2 and 5.3.2) | | N/A |
| B.1 | General requirements | | N/A |
| | Position | | — |
| | ManuFacterer | | — |
| | Type | | — |
| | Rated values | | — |
| B.2 | Test conditions | | N/A |
| B.3 | Maximum temperatures | | N/A |
| B.4 | Running overload test | | N/A |
| B.5 | Locked-rotor overload test | | N/A |
| | Test duration (days) | | — |
| | Electric strength test: test voltage (V) | | — |
| B.6 | Running overload test for d.c. motors in secondary circuits | | N/A |
| B.6.1 | General | | N/A |
| B.6.2 | Test procedure | | N/A |
| B.6.3 | Alternative test procedure | | N/A |
| B.6.4 | Electric strength test; test voltage (V) | | N/A |
| B.7 | Locked-rotor overload test for d.c. motors in secondary circuits | | N/A |
| B.7.1 | General | | N/A |
| B.7.2 | Test procedure | | N/A |
| B.7.3 | Alternative test procedure | | N/A |
| B.7.4 | Electric strength test; test voltage (V) | | N/A |
| B.8 | Test for motors with capacitors | | N/A |

| IEC 60950-1 | | | |
|--------------------|---|-----------------|------------|
| Clause | Requirement + Test | Result - Remark | Verdict |
| B.9 | Test for three-phase motors | | N/A |
| B.10 | Test for series motors | | N/A |
| | Operating voltage (V) | | — |
| C | ANNEX C, TRANSFORMERS (see 1.5.4 and 5.3.3) | | N/A |
| | Position | | — |
| | ManuFacterer | | — |
| | Type | | — |
| | Rated values | | — |
| | Method of protection | | — |
| C.1 | Overload test | | N/A |
| C.2 | Insulation | | N/A |
| | Protection from displacement of windings | | N/A |
| D | ANNEX D, MEASURING INSTRUMENTS FOR TOUCH-CURRENT TESTS (see 5.1.4) | | N/A |
| D.1 | Measuring instrument | | N/A |
| D.2 | Alternative measuring instrument | | N/A |
| E | ANNEX E, TEMPERATURE RISE OF A WINDING (see 1.4.13) | | N/A |
| F | ANNEX F, MEASUREMENT OF CLEARANCES AND CREEPAGE DISTANCES (see 2.10 and Annex G) | | N/A |
| G | ANNEX G, ALTERNATIVE METHOD FOR DETERMINING MINIMUM CLEARANCES | | N/A |
| G.1 | Clearances | | N/A |
| G.1.1 | General | | N/A |
| G.1.2 | Summary of the procedure for determining minimum clearances | | N/A |
| G.2 | Determination of mains transient voltage (V) | | N/A |
| G.2.1 | AC mains supply | | N/A |
| G.2.2 | Earthed d.c. mains supplies | | N/A |
| G.2.3 | Unearthed d.c. mains supplies | | N/A |
| G.2.4 | Battery operation | | N/A |
| G.3 | Determination of telecommunication network transient voltage (V) | | N/A |
| G.4 | Determination of required withstand voltage (V) | | N/A |

| IEC 60950-1 | | | |
|--------------------|--|-----------------|------------|
| Clause | Requirement + Test | Result - Remark | Verdict |
| G.4.1 | Mains transients and internal repetitive peaks : | | N/A |
| G.4.2 | Transients from telecommunication networks : | | N/A |
| G.4.3 | Combination of transients | | N/A |
| G.4.4 | Transients from cable distribution systems | | N/A |
| G.5 | Measurement of transient voltages (V) | | N/A |
| | a) Transients from a mains supply | | N/A |
| | For an a.c. mains supply | | N/A |
| | For a d.c. mains supply | | N/A |
| | b) Transients from a telecommunication network | | N/A |
| G.6 | Determination of minimum clearances : | | N/A |
| H | ANNEX H, IONIZING RADIATION (see 4.3.13) | | N/A |
| J | ANNEX J, TABLE OF ELECTROCHEMICAL POTENTIALS (see 2.6.5.6) | | N/A |
| | Metal(s) used : | | — |
| K | ANNEX K, THERMAL CONTROLS (see 1.5.3 and 5.3.8) | | N/A |
| K.1 | Making and breaking capacity | | N/A |
| K.2 | Thermostat reliability; operating voltage (V) : | | N/A |
| K.3 | Thermostat endurance test; operating voltage (V) : | | N/A |
| K.4 | Temperature limiter endurance; operating voltage (V) : | | N/A |
| K.5 | Thermal cut-out reliability | | N/A |
| K.6 | Stability of operation | | N/A |
| L | ANNEX L, NORMAL LOAD CONDITIONS FOR SOME TYPES OF ELECTRICAL BUSINESS EQUIPMENT (see 1.2.2.1 and 4.5.2) | | P |
| L.1 | Typewriters | | N/A |
| L.2 | Adding machines and cash registers | | N/A |
| L.3 | Erasers | | N/A |
| L.4 | Pencil sharpeners | | N/A |
| L.5 | Duplicators and copy machines | | N/A |
| L.6 | Motor-operated files | | N/A |
| L.7 | Other business equipment | See 1.6.2. | P |
| M | ANNEX M, CRITERIA FOR TELEPHONE RINGING SIGNALS (see 2.3.1) | | N/A |

| IEC 60950-1 | | | |
|--------------------|--|-----------------|------------|
| Clause | Requirement + Test | Result - Remark | Verdict |
| M.1 | Introduction | | N/A |
| M.2 | Method A | | N/A |
| M.3 | Method B | | N/A |
| M.3.1 | Ringling signal | | N/A |
| M.3.1.1 | Frequency (Hz) | | — |
| M.3.1.2 | Voltage (V) | | — |
| M.3.1.3 | Cadence; time (s), voltage (V) | | — |
| M.3.1.4 | Single fault current (mA) | | — |
| M.3.2 | Tripping device and monitoring voltage | | N/A |
| M.3.2.1 | Conditions for use of a tripping device or a monitoring voltage | | N/A |
| M.3.2.2 | Tripping device | | N/A |
| M.3.2.3 | Monitoring voltage (V) | | N/A |
| N | ANNEX N, IMPULSE TEST GENERATORS (see 1.5.7.2, 1.5.7.3, 2.10.3.9, 6.2.2.1, 7.3.2, 7.4.3 and Clause G.5) | | N/A |
| N.1 | ITU-T impulse test generators | | N/A |
| N.2 | IEC 60065 impulse test generator | | N/A |
| P | ANNEX P, NORMATIVE REFERENCES | | — |
| Q | ANNEX Q, Voltage dependent resistors (VDRs) (see 1.5.9.1) | | N/A |
| | a) Preferred climatic categories | | N/A |
| | b) Maximum continuous voltage | | N/A |
| | c) Pulse current | | N/A |
| R | ANNEX R, EXAMPLES OF REQUIREMENTS FOR QUALITY CONTROL PROGRAMMES | | N/A |
| R.1 | Minimum separation distances for unpopulated coated printed boards (see 2.10.6.2) | | N/A |
| R.2 | Reduced clearances (see 2.10.3) | | N/A |
| S | ANNEX S, PROCEDURE FOR IMPULSE TESTING (see 6.2.2.3) | | N/A |
| S.1 | Test equipment | | N/A |
| S.2 | Test procedure | | N/A |
| S.3 | Examples of waveforms during impulse testing | | N/A |

| IEC 60950-1 | | | |
|--------------------|---|------------------------|----------------|
| Clause | Requirement + Test | Result - Remark | Verdict |
| T | ANNEX T, GUIDANCE ON PROTECTION AGAINST INGRESS OF WATER (see 1.1.2) | | N/A |
| | | | — |
| U | ANNEX U, INSULATED WINDING WIRES FOR USE WITHOUT INTERLEAVED INSULATION (see 2.10.5.4) | | N/A |
| | | | — |
| V | ANNEX V, AC POWER DISTRIBUTION SYSTEMS (see 1.6.1) | | N/A |
| V.1 | Introduction | | N/A |
| V.2 | TN power distribution systems | | N/A |
| W | ANNEX W, SUMMATION OF TOUCH CURRENTS | | N/A |
| W.1 | Touch current from electronic circuits | | N/A |
| W.1.1 | Floating circuits | | N/A |
| W.1.2 | Earthed circuits | | N/A |
| W.2 | Interconnection of several equipments | | N/A |
| W.2.1 | Isolation | | N/A |
| W.2.2 | Common return, isolated from earth | | N/A |
| W.2.3 | Common return, connected to protective earth | | N/A |
| X | ANNEX X, MAXIMUM HEATING EFFECT IN TRANSFORMER TESTS | | N/A |
| X.1 | Determination of maximum input current | | N/A |
| X.2 | Overload test procedure | | N/A |
| Y | ANNEX Y, ULTRAVIOLET LIGHT CONDITIONING TEST (see 4.3.13.3) | | N/A |
| Y.1 | Test apparatus | | N/A |
| Y.2 | Mounting of test samples | | N/A |
| Y.3 | Carbon-arc light-exposure apparatus | | N/A |
| Y.4 | Xenon-arc light exposure apparatus | | N/A |
| Z | ANNEX Z, OVERVOLTAGE CATEGORIES (see 2.10.3.2 and Clause G.2) | | P |
| AA | ANNEX AA, MANDREL TEST (see 2.10.5.8) | | N/A |
| BB | ANNEX BB, CHANGES IN THE SECOND EDITION | | — |

| IEC 60950-1 | | | |
|--------------------|---|-----------------|------------|
| Clause | Requirement + Test | Result - Remark | Verdict |
| CC | ANNEX CC, Evaluation of integrated circuit (IC) current limiters | | N/A |
| CC.1 | General | | N/A |
| CC.2 | Test program 1.....: | | N/A |
| CC.3 | Test program 2.....: | | N/A |
| DD | ANNEX DD, Requirements for the mounting means of rack-mounted equipment | | N/A |
| DD.1 | General | | N/A |
| DD.2 | Mechanical strength test, variable N.....: | | N/A |
| DD.3 | Mechanical strength test, 250N, including end stops.....: | | N/A |
| DD.4 | Compliance.....: | | N/A |
| EE | ANNEX EE, Household and home/office document/media shredders | | N/A |
| EE.1 | General | | N/A |
| EE.2 | Markings and instructions | | N/A |
| | Use of markings or symbols.....: | | N/A |
| | Information of user instructions, maintenance and/or servicing instructions.....: | | N/A |
| EE.3 | Inadvertent reactivation test.....: | | N/A |
| EE.4 | Disconnection of power to hazardous moving parts: | | N/A |
| | Use of markings or symbols.....: | | N/A |
| EE.5 | Protection against hazardous moving parts | | N/A |
| | Test with test finger (Figure 2A) | | N/A |
| | Test with wedge probe (Figure EE1 and EE2) | | N/A |

| IEC 60950-1 | | | |
|-------------|--------------------|-----------------|---------|
| Clause | Requirement + Test | Result - Remark | Verdict |

| 1.5.1 | TABLE: list of critical components | | | | | P |
|-------------------------------|------------------------------------|--|--|-------------|---|---|
| Object/part no. | Manufacturer/ trademark | Type/model | Technical data | Standard | Mark(s) of conformity ¹ : | |
| LCD Panel for 21.5" models | CHIMEI INNOLUX | M215HG*-L** (* can be 0-9, A-Z, a-z, "-" or blank) | 21.5" panel with LED backlight The declared power consumption is 16.96W and backlight input voltage is 50V in specification. | IEC 60950-1 | Tested in equipment | |
| | CHI MEI | M215H*-L** (* can be 0-9, A-Z, a-z, "-" or blank) | 21.5" panel with LED backlight The declared power consumption is 12.55W and backlight input voltage is 41.6V in specification. | IEC 60950-1 | Tested in equipment | |
| | AUO | M215HW** (* can be 0-9, A-Z, a-z, "-" or blank) | 21.5" panel with LED backlight The declared power consumption is 16.1W and backlight input voltage is 36.3V in specification. | IEC 60950-1 | Tested in equipment | |
| | AUO | M215HTN**** (* can be 0-9, A-Z, a-z, "-" or blank) | 21.5" panel with LED backlight The declared power consumption is 15.634W and backlight input voltage is 38.4V in specification. | IEC 60950-1 | Tested in equipment | |
| | LG Display | LM215WF* (* can be 0-9, A-Z, a-z, "-" or blank) | 21.5" panel with LED backlight The declared power consumption is 16W and backlight input voltage is 57.6V in specification. | IEC 60950-1 | Tested in equipment | |

| IEC 60950-1 | | | | | |
|-------------|--------------------|---|---|-------------|------------------------|
| Clause | Requirement + Test | | Result - Remark | Verdict | |
| | BOE | HT215F**_*** (* can be 0-9, A-Z, a-z, "-" or blank) | 21.5" panel with LED backlight The declared power consumption is 16.56W and backlight input voltage is 54.4V in specification. | IEC 60950-1 | Tested in equipment |
| | BOE | HR215WU*_*** (* can be 0-9, A-Z, a-z, "-" or blank) | 21.5" panel with LED backlight The declared power consumption is 24.87W and backlight input voltage is 41.6V in specification. | IEC 60950-1 | Tested in equipment |
| | BOE | HM215WU*_*** (* can be 0-9, A-Z, a-z, "-" or blank) | 21.5" panel with LED backlight The declared power consumption is 17.19W and backlight input voltage is 51.2V in specification. | IEC 60950-1 | Tested in equipment |
| | TPV | TPM215HW** (* can be 0-9, A-Z, a-z, "-" or blank) | 21.5" panel with LED backlight The declared power consumption is 19.7W and backlight input voltage is 41.6V in specification. | IEC 60950-1 | Tested in equipment |
| | CPT | CLAA215FA** (* can be 0-9, A-Z, a-z, "-" or blank) | 21.5" panel with LED backlight The declared power consumption is 14.6W and backlight input voltage is 30V in specification. | IEC 60950-1 | Tested in equipment |
| | Samsung | LTM215HT** (* can be 0-9, A-Z, a-z, "-" or blank) | 21.5" panel with LED backlight The declared power consumption is 15.82W and backlight input voltage is 52.8V in specification. | IEC 60950-1 | Tested in equipment |

| IEC 60950-1 | | | | | |
|-------------------------------|--------------------|---|--|-------------|------------------------|
| Clause | Requirement + Test | | Result - Remark | Verdict | |
| | L&T | BM215WF* (* can be 0-9, A-Z, a-z, "-" or blank) | 21.5" panel with LED backlight The declared power consumption is 17.3W and backlight input voltage is 51.2V in specification. | IEC 60950-1 | Tested in equipment |
| LCD Panel for 23.6" models | TPV | TPM236** (* can be 0-9, A-Z, a-z, "-" or blank) | 23.6" panel with LED backlight The declared power consumption is 16.79W and backlight input voltage is 51.2V in specification. | IEC 60950-1 | Tested in equipment |
| | CHIMEI INNOLUX | M236H*_*_*_* (* can be 0-9, A- Z, a-z, "-" or blank) | 23.6" panel with LED backlight The declared power consumption is 18.95W and backlight input voltage is 28.8V in specification. | IEC 60950-1 | Tested in equipment |
| | CHIMEI INNOLUX | M236H**_*_*_* (* can be 0-9, A- Z, a-z, "-" or blank, except for M236HGJ-L21) | 23.6" panel with LED backlight The declared power consumption is 20.076W and backlight input voltage is 46.5V in specification. | IEC 60950-1 | Tested in equipment |
| | CHIMEI INNOLUX | M236HGJ-L21 | 23.6" panel with LED backlight The declared power consumption is 19.09W and backlight input voltage is 43.4V in specification. | IEC 60950-1 | Tested in equipment |
| | IVO | M236MWF* (* can be 0-9, A-Z, a-z, "-" or blank) | 23.6" panel with LED backlight The declared power consumption is 17.7W and backlight input voltage is 31.5V in specification. | IEC 60950-1 | Tested in equipment |

| IEC 60950-1 | | | | | |
|-------------------|--------------------|--|---|-------------|---------------------|
| Clause | Requirement + Test | | Result - Remark | Verdict | |
| | BOE | HM236W**.* (* can be 0-9, A-Z, a-z, "-" or blank) | 23.6" panel with LED backlight The declared power consumption is 20.4W and backlight input voltage is 35.2V in specification. | IEC 60950-1 | Tested in equipment |
| | BOE | HR236WU*.* (* can be 0-9, A-Z, a-z, "-" or blank) | 23.6" panel with LED backlight The declared power consumption is 20.02W and backlight input voltage is 57.6V in specification. | IEC 60950-1 | Tested in equipment |
| Plastic enclosure | Cheil | SD-0150(+), VH-0810(+), VE-0812(+), NH-1000T(+), GC-0700(+), GC-1017(+), GC-0750(+), VE-1890(+), TP-1100(+), BF-0675(+), BF-0670(+), NH-1017(p), BF-0677(+), HS-7000(+), HG-0760(+), HR-1360(+) | HB or better, 2.0mm thickness min. 60°C | UL 94 | UL |
| | Grand | D-150, D-1000 | HB or better, 2.0mm thickness min. 60°C | UL 94 | UL |
| | LG | HF-350, HF-380, AF312T1, AF342T, GN-5001TF(#), GN-5001RFD, GP-5008A-F, SE750(#), XG-568, XG-569C, GP-1000L, SE-750, LUPOY GN-5001RF(T) | HB or better, 2.0mm thickness min. 60°C | UL 94 | UL |
| | Chi Mei | PA-757(+), PH-88 | HB or better, 2.0mm thickness min. 60°C | UL 94 | UL |

| IEC 60950-1 | | | | | |
|--------------------------|--|---|---|---|--|
| Clause | Requirement + Test | | Result - Remark | Verdict | |
| | King Fa | 5197, HIPS-5197, HF-606, HF-626, FRABS-518, GAR-011C, JH960 6(M), FRHIPS-960, RS-900, RS-300, RS-400, GAR-011(L65), GAR-011(HG6), CK-100 | HB or better, 2.0mm thickness min. 60°C | UL 94 | UL |
| | Basf | GP-35, GP-22, 495F | HB or better, 2.0mm thickness min. 60°C | UL 94 | UL |
| | Bayer | FR2000, FR3005 | HB or better, 2.0mm thickness min. 60°C | UL 94 | UL |
| | Teijin | TN-7500(v), TN-7500F(#), MN-3600H(#) | HB or better, 2.0mm thickness min. 60°C | UL 94 | UL |
| | STYRON | STYRON A-TECH 1400 | HB or better, 2.0mm thickness min. 60°C | UL 94 | UL |
| | Haier | HRABS-RS, HRABS-HG, CR-3002 | HB or better, 2.0mm thickness min. 60°C | UL 94 | UL |
| | HINGLONG | HL-ABS-PCR85, HL-ABS-PCR65 | HB or better, 2.0mm thickness min. 60°C | UL 94 | UL |
| | Various | Various | HB or better, 2.0mm thickness min. 60°C | UL 94 | UL |
| Base stand (optional) | -- | -- | HB or better | UL 94 | UL |
| PCB | -- | -- | V-1 or better, min. 105°C | UL 94 | UL |
| Speaker (two sets) | -- | -- | Each max. 8Ω, max. 4.5 W | -- | -- |
| AC/DC Adapter | TPV Electronics (Fujian) Co., Ltd. | ADPC1965**** (* can be A-Z, a- z, 0-9, "+", "-", "\v" or blank) | I/P: 100-240Vac, 1.5A, 50-60Hz; O/P: DC 19V, 3.42A; 40°C, 5000m Comply with LPS | IEC 60950- 1:2005+Am 1:2009, EN 60950- 1:2006+A11:2 009+A1:2010 +A12:2011 | Nemko CB (Ref. Certif. No. NO68767) * |

| IEC 60950-1 | | | | | |
|--|--------------------|---------|---|---|---------|
| Clause | Requirement + Test | | | Result - Remark | Verdict |
| | Various | Various | I/P: 100-240Vac, 1.5A, 50-60Hz; O/P: DC 19V, 3.42A; 40°C, 5000m Comply with LPS | IEC 60950- 1:2005+Am 1:2009, EN 60950- 1:2006+A11:2 009+A1:2010 +A12:2011 | CB * |
| Supplementary information: | | | | | |
| <ol style="list-style-type: none"> 1. Provided evidence ensures the agreed level of compliance. 2. * indicates compliance to National requirements need to be evaluated during the National approval for this product. | | | | | |

| IEC 60950-1 | | | | | | |
|---|--|-------|-------|-------|-----------------|---------------------|
| Clause | Requirement + Test | | | | Result - Remark | Verdict |
| 1.6.2 | TABLE: electrical data (in normal conditions) | | | | | P |
| Fuse # | I rated (A) | U(V) | P (W) | I (A) | Ifuse (A) | Condition/status |
| Test on model 215LM000** with panel HR215WU*~*** (BOE) | | | | | | |
| VGA mode | | | | | | |
| -- | 3.42 | 18.80 | 45.01 | 2.39 | -- | Maximum normal load |
| HDMI mode | | | | | | |
| -- | 3.42 | 18.75 | 54.52 | 2.91 | -- | Maximum normal load |
| Test on model 236LM000** with panel M236H*~*** (CHIMEI INNOLUX) | | | | | | |
| VGA mode | | | | | | |
| -- | 3.42 | 18.80 | 46.11 | 2.45 | -- | Maximum normal load |
| HDMI mode | | | | | | |
| -- | 3.42 | 18.74 | 55.71 | 2.97 | -- | Maximum normal load |
| Supplementary information: | | | | | | |
| 1. Maximum normal load: maximum brightness, maximum contrast, full white screen; speakers were loaded with 1KHz sinusoidal signal and adjusted to maximum volume; each USB2.0 port loaded 5V/0.5A; each USB3.0 port loaded 5V/0.9A; quickly charge USB port loaded 5V/1.5A. | | | | | | |
| 2. Panel chosen for the test due to the highest power consumption specified in panel specification than any other panel of same size. | | | | | | |

| 2.2.2 | TABLE: Hazardous voltage measurement | | | P |
|---|---|--------|--------------------------------|----------|
| Component (measured between) | max. voltage (V) (normal operation) | | Voltage Limiting Components | |
| | V peak | V d.c. | | |
| Test on model 215LM000** | | | | |
| After D8101 to earth (converter output) | -- | 54.3 | | |
| Test on model 236LM000** | | | | |
| After D8101 to earth (converter output) | -- | 55.7 | | |
| Fault test performed on voltage limiting components | Voltage measured (V) in SELV circuits (V peak or V d.c.) | | | |
| Test on model 215LM000** | | | | |
| D8101 short | 0 (unit shut down) | | | |
| Test on model 236LM000** | | | | |
| D8101 short | 0 (unit shut down) | | | |
| Supplementary information: | | | | |

| IEC 60950-1 | | | |
|-----------------------------------|------------------------------------|-----------------|-------------------------------|
| Clause | Requirement + Test | Result - Remark | Verdict |
| 4.5 | TABLE: maximum temperatures | | P |
| | test voltage (V) | 19Vdc | — |
| | t1 (°C) | -- | — |
| | t2 (°C) | -- | — |
| Maximum temperature T of part/at: | | T (°C) | allowed T _{max} (°C) |
| Test on model 215LM000** | | | |
| DC inlet CN701 (on main board) | | 39.7 | 55.7 |
| PCB near U601 (on main board) | | 65.2 | 90.7 |
| L701 body (on main board) | | 66.5 | 90.7 |
| C729 body (on main board) | | 57.2 | 70.7 |
| PCB near U708 (on USB board) | | 53.2 | 90.7 |
| PCB near U401 (on main board) | | 59.3 | 90.7 |
| PCB near D601 (on main board) | | 54.2 | 90.7 |
| L8101 body (on main board) | | 68.4 | 90.7 |
| Plastic enclosure inside | | 38.2 | -- |
| Plastic enclosure outside | | 30.2 | 45.7 |
| Metal chassis | | 40.2 | 55.7 |
| Panel surface | | 41.7 | 80.7 |
| Ambient | | 25.7 | -- |
| Test on model 236LM000** | | | |
| DC inlet CN701 (on main board) | | 39.9 | 56.5 |
| PCB near U601 (on main board) | | 66.6 | 91.5 |
| L701 body (on main board) | | 67.7 | 91.5 |
| C729 body (on main board) | | 57.8 | 71.5 |
| PCB near U708 (on USB board) | | 54.3 | 91.5 |
| PCB near U401 (on main board) | | 59.9 | 91.5 |
| PCB near D601 (on main board) | | 55.7 | 91.5 |
| L8101 body (on main board) | | 68.8 | 91.5 |
| Plastic enclosure inside | | 39.1 | -- |
| Plastic enclosure outside | | 31.6 | 46.5 |
| Metal chassis | | 39.8 | 56.5 |
| Panel surface | | 42.9 | 81.5 |
| Ambient | | 26.5 | -- |

| IEC 60950-1 | | | | | |
|--|-----------------------|-----------------------|-----------|----------------------------------|---------------------|
| Clause | Requirement + Test | | | Result - Remark | Verdict |
| Temperature T of winding: | | | | | |
| | R ₁ (Ω) | R ₂ (Ω) | T (°C) | allowed T _{max} (°C) | insulation class |
| Supplementary information: | | | | | |
| 1. The temperatures were measured under the worse case normal mode defined in 1.2.2.1 and in HDMI mode as described in sub-clause 1.6.2 at voltage as described above. | | | | | |
| 2. With a specified ambient temperature of 40°C. Temperature limits are calculated as follows: | | | | | |
| - T _{max} = T _{max} of component - 40 + T _{amb} | | | | | |

| 5.3 | TABLE: Fault condition tests | | | | | P |
|---------------|---|--------------------|-----------|--------|------------------|--|
| | Ambient temperature (°C) | | | | See below | — |
| | Power source for EUT: ManuFacterer, model/type, output rating | | | | | — |
| Component No. | Fault | Supply voltage (V) | Test time | Fuse # | Fuse current (A) | Observation |
| D603 | s-c | 19Vdc | 5 min | -- | -- | Unit shut down, no hazard. |
| L601 | s-c | 19Vdc | 5 min | -- | -- | Unit shut down, no hazard. |
| C729 | s-c | 19Vdc | 5 min | -- | -- | Unit shut down, no hazard. |
| C631 | s-c | 19Vdc | 5 min | -- | -- | Unit shut down, no hazard. |
| D702 | s-c | 19Vdc | 5 min | -- | -- | Unit shut down, no hazard. |
| C8109 | s-c | 19Vdc | 5 min | -- | -- | Unit shut down, no hazard. |
| L8101 | s-c | 19Vdc | 5 min | -- | -- | Unit shut down, no hazard. |
| D8101 | s-c | 19Vdc | 5 min | -- | -- | Unit shut down, no hazard. |
| Speaker | s-c | 19Vdc | 5 min | -- | -- | Unit operated normally, no damaged, no hazard. |

Test on model 215LM000**

| IEC 60950-1 | | | | | | |
|--------------------------|--------------------|-------|-------|----|-----------------|--|
| Clause | Requirement + Test | | | | Result - Remark | Verdict |
| USB2.0 | o-l | 19Vdc | 4 hrs | -- | -- | Max. measured temp. in PCB near U601 = 68.4°C, L701 body = 71.0°C, L8108 body = 69.1°C, ambient = 25.8°C, before shut down the USB port is loaded to 1.0A. No hazards. |
| USB3.0 | o-l | 19Vdc | 4 hrs | -- | -- | Max. measured temp. in PCB near U601 = 71.0°C, L701 body = 72.7°C, L8108 body = 70.4°C, ambient = 26.0°C, before shut down the USB port is loaded to 2.0A. No hazards. |
| Quickly charge USB | o-l | 19Vdc | 4 hrs | -- | -- | Max. measured temp. in PCB near U601 = 70.7°C, L701 body = 70.8°C, L8108 body = 70.4°C, ambient = 25.2°C, before shut down the USB port is loaded to 2.3A. No hazards. |
| Test on model 236LM000** | | | | | | |
| USB2.0 | o-l | 19Vdc | 4 hrs | -- | -- | Max. measured temp. in PCB near U601 = 69.1°C, L701 body = 70.2°C, L8108 body = 69.4°C, ambient = 25.0°C, before shut down the USB port is loaded to 1.0A. No hazards. |
| USB3.0 | o-l | 19Vdc | 4 hrs | -- | -- | Max. measured temp. in PCB near U601 = 73.2°C, L701 body = 70.3°C, L8108 body = 68.1°C, ambient = 25.1°C, before shut down the USB port is loaded to 2.0A. No hazards. |

| IEC 60950-1 | | | | | | |
|---|--------------------|-------|-------|----|-----------------|--|
| Clause | Requirement + Test | | | | Result - Remark | Verdict |
| Quickly charge USB | o-l | 19Vdc | 4 hrs | -- | -- | Max. measured temp. in PCB near U601 = 72.4°C, L701 body = 69.7°C, L8108 body = 69.7°C, ambient = 26.8°C, before shut down the USB port is loaded to 2.3A. No hazards. |
| Supplementary information: | | | | | | |
| <ol style="list-style-type: none"> In fault column, where s-c=short-circuited, o-l=overload. With a specified ambient temperature of 40°C. Temperature limits are calculated as follows: $T_{max} = T_{max \text{ of component}} - 40 + T_{amb}$ | | | | | | |

| IEC60950_1C - ATTACHMENT | | | |
|--------------------------|--------------------|-----------------|---------|
| Clause | Requirement + Test | Result - Remark | Verdict |

| ATTACHMENT TO TEST REPORT IEC 60950-1 EUROPEAN GROUP DIFFERENCES AND NATIONAL DIFFERENCES Information technology equipment – Safety – Part 1: General requirements | |
|---|---|
| Differences according to.....: | EN 60950-1:2006/A11:2009/A1:2010/A12:2011 |
| Attachment Form No.....: | EU_GD_IEC60950_1C_II |
| Attachment Originator.....: | SGS Fimko Ltd |
| Master Attachment.....: | Date 2011-08 |
| Copyright © 2011 IEC System for Conformity Testing and Certification of Electrical Equipment (IECEE), Geneva, Switzerland. All rights reserved. | |

| EN 60950-1:2006/A11:2009/A1:2010/A12:2011 – CENELEC COMMON MODIFICATIONS |
|--|
|--|

| IEC 60950-1, GROUP DIFFERENCES (CENELEC common modifications EN) | | |
|--|---|----------|
| Contents | Add the following annexes: Annex ZA (normative) Normative references to international publications with their corresponding European publications Annex ZB (normative) Special national conditions | P |
| General | Delete all the “country” notes in the reference document (IEC 60950-1:2005) according to the following list: 1.4.8 Note 2 1.5.1 Note 2 & 3 1.5.7.1 Note 1.5.8 Note 2 1.5.9.4 Note 1.7.2.1 Note 4, 5 & 6 2.2.3 Note 2.2.4 Note 2.3.2 Note 2.3.2.1 Note 2 2.3.4 Note 2 2.6.3.3 Note 2 & 3 2.7.1 Note 2.10.3.2 Note 2 2.10.5.13 Note 3 3.2.1.1 Note 3.2.4 Note 3. 2.5.1 Note 2 4.3.6 Note 1 & 2 4.7 Note 4 4.7.2.2 Note 4.7.3.1 Note 2 5.1.7.1 Note 3 & 4 5.3.7 Note 1 6 Note 2 & 5 6.1.2.1 Note 2 6.1.2.2 Note 6.2.2 Note 6.2.2.1 Note 2 6.2.2.2 Note 7.1 Note 3 7.2 Note 7.3 Note 1 & 2 G.2.1 Note 2 Annex H Note 2 | P |
| General (A1:2010) | Delete all the “country” notes in the reference document (IEC 60950-1:2005/A1:2010) according to the following list: 1.5.7.1 Note 6.1.2.1 Note 2 6.2.2.1 Note 2 EE.3 Note | P |

| IEC60950_1C - ATTACHMENT | | | |
|--------------------------|--|-----------------|---------|
| Clause | Requirement + Test | Result - Remark | Verdict |
| 1.3.Z1 | <p>Add the following subclause:</p> <p>1.3.Z1 Exposure to excessive sound pressure The apparatus shall be so designed and constructed as to present no danger when used for its intended purpose, either in normal operating conditions or under fault conditions, particularly providing protection against exposure to excessive sound pressures from headphones or earphones.</p> <p>NOTE Z1 A new method of measurement is described in EN 50332-1, Sound system equipment: Headphones and earphones associated with portable audio equipment - Maximum sound pressure level measurement methodology and limit considerations - Part 1: General method for "one package equipment", and in EN 50332-2, Sound system equipment: Headphones and earphones associated with portable audio equipment - Maximum sound pressure level measurement methodology and limit considerations - Part 2: Guidelines to associate sets with headphones coming from different manufacturers.</p> | Added. | N/A |
| (A12:2011) | <p>In EN 60950-1:2006/A12:2011 Delete the addition of 1.3.Z1 / EN 60950-1:2006 Delete the definition 1.2.3.Z1 / EN 60950-1:2006 /A1:2010</p> | Deleted. | N/A |
| 1.5.1 | <p>Add the following NOTE:</p> <p>NOTE Z1 The use of certain substances in electrical and electronic equipment is restricted within the EU: see Directive 2002/95/EC</p> | Added. | P |
| 1.7.2.1 (A1:2010) | <p>In addition, for a PORTABLE SOUND SYSTEM, the instructions shall include a warning that excessive sound pressure from earphones and headphones can cause hearing loss.</p> | Added. | N/A |
| 1.7.2.1 (A12.2011) | <p>In EN 60950-1:2006/A12:2011 Delete NOTE Z1 and the addition for Portable Sound System. Add the following clause and annex to the existing standard and amendments.</p> | | N/A |
| | Zx Protection against excessive sound pressure from personal music players | | N/A |

| IEC60950_1C - ATTACHMENT | | | |
|--------------------------|--|---------------------------|---------|
| Clause | Requirement + Test | Result - Remark | Verdict |
| | <p>Zx.1 General</p> <p>This sub-clause specifies requirements for protection against excessive sound pressure from personal music players that are closely coupled to the ear. It also specifies requirements for earphones and headphones intended for use with personal music players.</p> <p>A personal music player is a portable equipment for personal use, that:</p> <ul style="list-style-type: none"> – is designed to allow the user to listen to recorded or broadcast sound or video; and – primarily uses headphones or earphones that can be worn in or on or around the ears; and – allows the user to walk around while in use. <p>NOTE 1 Examples are hand-held or body-worn portable CD players, MP3 audio players, mobile phones with MP3 type features, PDA's or similar equipment.</p> <p>A personal music player and earphones or headphones intended to be used with personal music players shall comply with the requirements of this sub-clause.</p> <p>The requirements in this sub-clause are valid for music or video mode only.</p> <p>The requirements do not apply:</p> <ul style="list-style-type: none"> – while the personal music player is connected to an external amplifier; or – while the headphones or earphones are not used. <p>NOTE 2 An external amplifier is an amplifier which is not part of the personal music player or the listening device, but which is intended to play the music as a standalone music player.</p> <p>The requirements do not apply to:</p> <ul style="list-style-type: none"> – hearing aid equipment and professional equipment; <p>NOTE 3 Professional equipment is equipment sold through special sales channels. All products sold through normal electronics stores are considered not to be professional equipment.</p> | Not personal music player | N/A |

| IEC60950_1C - ATTACHMENT | | | |
|--------------------------|--|-----------------|------------|
| Clause | Requirement + Test | Result - Remark | Verdict |
| | <p>– analogue personal music players (personal music players without any kind of digital processing of the sound signal) that are brought to the market before the end of 2015.</p> <p>NOTE 4 This exemption has been allowed because this technology is falling out of use and it is expected that within a few years it will no longer exist. This exemption will not be extended to other technologies.</p> <p>For equipment which is clearly designed or intended for use by young children, the limits of EN 71-1 apply.</p> | | |
| | <p>Zx.2 Equipment requirements</p> <p>No safety provision is required for equipment that complies with the following:</p> <ul style="list-style-type: none"> – equipment provided as a package (personal music player with its listening device), where the acoustic output $L_{Aeq,T}$ is ≤ 85 dBA measured while playing the fixed “programme simulation noise” as described in EN 50332-1; and – a personal music player provided with an analogue electrical output socket for a listening device, where the electrical output is ≤ 27 mV measured as described in EN 50332-2, while playing the fixed “programme simulation noise” as described in EN 50332-1. <p>NOTE 1 Wherever the term acoustic output is used in this clause, the 30 s A-weighted equivalent sound pressure level $L_{Aeq,T}$ is meant. See also Zx.5 and Annex Zx.</p> <p>All other equipment shall:</p> <ol style="list-style-type: none"> a) protect the user from unintentional acoustic outputs exceeding those mentioned above; and b) have a standard acoustic output level not exceeding those mentioned above, and automatically return to an output level not exceeding those mentioned above when the power is switched off; and | | N/A |

| IEC60950_1C - ATTACHMENT | | | |
|--------------------------|---|-----------------|---------|
| Clause | Requirement + Test | Result - Remark | Verdict |
| | <p>c) provide a means to actively inform the user of the increased sound pressure when the equipment is operated with an acoustic output exceeding those mentioned above. Any means used shall be acknowledged by the user before activating a mode of operation which allows for an acoustic output exceeding those mentioned above. The acknowledgement does not need to be repeated more than once every 20 h of cumulative listening time; and</p> <p>NOTE 2 Examples of means include visual or audible signals. Action from the user is always required.</p> <p>NOTE 3 The 20 h listening time is the accumulative listening time, independent how often and how long the personal music player has been switched off.</p> <p>d) have a warning as specified in Zx.3; and</p> <p>e) not exceed the following:</p> <ol style="list-style-type: none"> 1) equipment provided as a package (player with its listening device), the acoustic output shall be ≤ 100 dBA measured while playing the fixed "programme simulation noise" described in EN 50332-1; and 2) a personal music player provided with an analogue electrical output socket for a listening device, the electrical output shall be ≤ 150 mV measured as described in EN 50332-2, while playing the fixed "programme simulation noise" described in EN 50332-1. <p>For music where the average sound pressure (long term $L_{Aeq,T}$) measured over the duration of the song is lower than the average produced by the programme simulation noise, the warning does not need to be given as long as the average sound pressure of the song is below the basic limit of 85 dBA. In this case T becomes the duration of the song.</p> <p>NOTE 4 Classical music typically has an average sound pressure (long term $L_{Aeq,T}$) which is much lower than the average programme simulation noise. Therefore, if the player is capable to analyse the song and compare it with the programme simulation noise, the warning does not need to be given as long as the average sound pressure of the song is below the basic limit of 85 dBA.</p> <p>For example, if the player is set with the programme simulation noise to 85 dBA, but the average music level of the song is only 65 dBA, there is no need to give a warning or ask an acknowledgement as long as the average sound level of the song is not above the basic limit of 85 dBA.</p> | | N/A |

| IEC60950_1C - ATTACHMENT | | | |
|--------------------------|---|-----------------|---------|
| Clause | Requirement + Test | Result - Remark | Verdict |
| | <p>Zx.3 Warning</p> <p>The warning shall be placed on the equipment, or on the packaging, or in the instruction manual and shall consist of the following:</p> <ul style="list-style-type: none"> – the symbol of Figure 1 with a minimum height of 5 mm; and – the following wording, or similar: <p>“To prevent possible hearing damage, do not listen at high volume levels for long periods.”</p> <div style="text-align: center;">  </div> <p>Figure 1 – Warning label (IEC 60417-6044)</p> <p>Alternatively, the entire warning may be given through the equipment display during use, when the user is asked to acknowledge activation of the higher level.</p> | | N/A |
| | Zx.4 Requirements for listening devices (headphones and earphones) | | N/A |
| | <p>Zx.4.1 Wired listening devices with analogue input</p> <p>With 94 dBA sound pressure output $L_{Aeq,T}$, the input voltage of the fixed “programme simulation noise” described in EN 50332-2 shall be ≥ 75 mV.</p> <p>This requirement is applicable in any mode where the headphones can operate (active or passive), including any available setting (for example built-in volume level control).</p> <p>NOTE The values of 94 dBA – 75 mV correspond with 85dBA – 27 mV and 100 dBA – 150 mV.</p> | | N/A |

| IEC60950_1C - ATTACHMENT | | | |
|--------------------------|--|-----------------|---------|
| Clause | Requirement + Test | Result - Remark | Verdict |
| | <p>Zx.4.2 Wired listening devices with digital input</p> <p>With any playing device playing the fixed "programme simulation noise" described in EN 50332-1 (and respecting the digital interface standards, where a digital interface standard exists that specifies the equivalent acoustic level), the acoustic output $L_{Aeq,T}$ of the listening device shall be ≤ 100 dBA.</p> <p>This requirement is applicable in any mode where the headphones can operate, including any available setting (for example built-in volume level control, additional sound feature like equalization, etc.).</p> <p>NOTE An example of a wired listening device with digital input is a USB headphone.</p> | | N/A |
| | <p>Zx.4.3 Wireless listening devices</p> <p>In wireless mode:</p> <ul style="list-style-type: none"> – with any playing and transmitting device playing the fixed programme simulation noise described in EN 50332-1; and – respecting the wireless transmission standards, where an air interface standard exists that specifies the equivalent acoustic level; and – with volume and sound settings in the listening device (for example built-in volume level control, additional sound feature like equalization, etc.) set to the combination of positions that maximize the measured acoustic output for the abovementioned programme simulation noise, the acoustic output $L_{Aeq,T}$ of the listening device shall be ≤ 100 dBA. <p>NOTE An example of a wireless listening device is a Bluetooth headphone.</p> | | N/A |
| | <p>Zx.5 Measurement methods</p> <p>Measurements shall be made in accordance with EN 50332-1 or EN 50332-2 as applicable. Unless stated otherwise, the time interval T shall be 30 s.</p> <p>NOTE Test method for wireless equipment provided without listening device should be defined.</p> | | N/A |

| IEC60950_1C - ATTACHMENT | | | | | | | | | |
|--------------------------------|--|-----------------------|--------------------|-------------------------------|--------------------------|--------------------------------|-------------------------|--|-----|
| Clause | Requirement + Test | Result - Remark | Verdict | | | | | | |
| 2.7.1 | <p>Replace the subclause as follows:</p> <p>Basic requirements</p> <p>To protect against excessive current, short-circuits and earth faults in PRIMARY CIRCUITS, protective devices shall be included either as integral parts of the equipment or as parts of the building installation, subject to the following, a), b) and c):</p> <p>a) except as detailed in b) and c), protective devices necessary to comply with the requirements of 5.3 shall be included as parts of the equipment;</p> <p>b) for components in series with the mains input to the equipment such as the supply cord, appliance coupler, r.f.i. filter and switch, short-circuit and earth fault protection may be provided by protective devices in the building installation;</p> | Replaced. | N/A | | | | | | |
| | <p>c) it is permitted for PLUGGABLE EQUIPMENT TYPE B or PERMANENTLY CONNECTED EQUIPMENT, to rely on dedicated overcurrent and short-circuit protection in the building installation, provided that the means of protection, e.g. fuses or circuit breakers, is fully specified in the installation instructions.</p> <p>If reliance is placed on protection in the building installation, the installation instructions shall so state, except that for PLUGGABLE EQUIPMENT TYPE A the building installation shall be regarded as providing protection in accordance with the rating of the wall socket outlet.</p> | | N/A | | | | | | |
| 2.7.2 | This subclause has been declared 'void'. | | N/A | | | | | | |
| 3.2.3 | Delete the NOTE in Table 3A, and delete also in this table the conduit sizes in parentheses. | | N/A | | | | | | |
| 3.2.5.1 | <p>Replace "60245 IEC 53" by "H05 RR-F";</p> <p>"60227 IEC 52" by "H03 VV-F or H03 VVH2-F";</p> <p>"60227 IEC 53" by "H05 VV-F or H05 VVH2-F2".</p> <p>In Table 3B, replace the first four lines by the following:</p> <table border="0"> <tr> <td>Up to and including 6 </td> <td>0,75^{a)} </td> </tr> <tr> <td>Over 6 up to and including 10 </td> <td>(0,75)^{b)} 1,0 </td> </tr> <tr> <td>Over 10 up to and including 16 </td> <td>(1,0)^{c)} 1,5 </td> </tr> </table> <p>In the conditions applicable to Table 3B delete the words "in some countries" in condition^{a)}.</p> <p>In NOTE 1, applicable to Table 3B, delete the second sentence.</p> | Up to and including 6 | 0,75 ^{a)} | Over 6 up to and including 10 | (0,75) ^{b)} 1,0 | Over 10 up to and including 16 | (1,0) ^{c)} 1,5 | | N/A |
| Up to and including 6 | 0,75 ^{a)} | | | | | | | | |
| Over 6 up to and including 10 | (0,75) ^{b)} 1,0 | | | | | | | | |
| Over 10 up to and including 16 | (1,0) ^{c)} 1,5 | | | | | | | | |

| IEC60950_1C - ATTACHMENT | | | |
|--------------------------|--|-----------------|---------|
| Clause | Requirement + Test | Result - Remark | Verdict |
| 3.3.4 | In Table 3D, delete the fourth line: conductor sizes for 10 to 13 A, and replace with the following: Over 10 up to and including 16 1,5 to 2,5 1,5 to 4 Delete the fifth line: conductor sizes for 13 to 16 A | | N/A |
| 4.3.13.6 (A1:2010) | Replace the existing NOTE by the following: NOTE Z1 Attention is drawn to: 1999/519/EC: Council Recommendation on the limitation of exposure of the general public to electromagnetic fields 0 Hz to 300 GHz, and 2006/25/EC: Directive on the minimum health and safety requirements regarding the exposure of workers to risks arising from physical agents (artificial optical radiation). | | N/A |
| | Standards taking into account mentioned Recommendation and Directive which demonstrate compliance with the applicable EU Directive are indicated in the OJEC. | | N/A |
| Annex H | Replace the last paragraph of this annex by: At any point 10 cm from the surface of the OPERATOR ACCESS AREA, the dose rate shall not exceed 1 µSv/h (0,1 mR/h) (see NOTE). Account is taken of the background level. Replace the notes as follows: NOTE These values appear in Directive 96/29/Euratom. Delete NOTE 2. | | N/A |
| Bibliography | Additional EN standards. | | — |

| | | |
|-----------|--|---|
| ZA | NORMATIVE REFERENCES TO INTERNATIONAL PUBLICATIONS WITH THEIR CORRESPONDING EUROPEAN PUBLICATIONS | — |
|-----------|--|---|

| ZB ANNEX (normative) SPECIAL NATIONAL CONDITIONS (EN) | | | |
|--|--|-----------------|---------|
| Clause | Requirement + Test | Result - Remark | Verdict |
| 1.2.4.1 | In Denmark , certain types of Class I appliances (see 3.2.1.1) may be provided with a plug not establishing earthing conditions when inserted into Danish socket-outlets. | | N/A |
| 1.2.13.14 | In Norway and Sweden , for requirements see 1.7.2.1 and 7.3 of this annex. | | N/A |

| IEC60950_1C - ATTACHMENT | | | |
|--------------------------|---|-----------------|------------|
| Clause | Requirement + Test | Result - Remark | Verdict |
| 1.5.7.1 | In Finland, Norway and Sweden , resistors bridging BASIC INSULATION in CLASS I PLUGGABLE EQUIPMENT TYPE A must comply with the requirements in 1.5.7.1. In addition when a single resistor is used, the resistor must withstand the resistor test in 1.5.7.2. | | N/A |
| 1.5.8 | In Norway , due to the IT power system used (see annex V, Figure V.7), capacitors are required to be rated for the applicable line-to-line voltage (230 V). | | N/A |
| 1.5.9.4 | In Finland, Norway and Sweden , the third dashed sentence is applicable only to equipment as defined in 6.1.2.2 of this annex. | | N/A |

| IEC60950_1C - ATTACHMENT | | | |
|--------------------------|--|-----------------|---------|
| Clause | Requirement + Test | Result - Remark | Verdict |
| 1.7.2.1 | <p>In Finland, Norway and Sweden, CLASS I PLUGGABLE EQUIPMENT TYPE A intended for connection to other equipment or a network shall, if safety relies on connection to protective earth or if surge suppressors are connected between the network terminals and accessible parts, have a marking stating that the equipment must be connected to an earthed mains socket-outlet. The marking text in the applicable countries shall be as follows:</p> <p>In Finland: "Laite on liitettävä suojakoskettimilla varustettuun pistorasiaan"</p> <p>In Norway: "Apparatet må tilkoples jordet stikkontakt"</p> <p>In Sweden: "Apparaten skall anslutas till jordat uttag"</p> <p>In Norway and Sweden, the screen of the cable distribution system is normally not earthed at the entrance of the building and there is normally no equipotential bonding system within the building. Therefore the protective earthing of the building installation need to be isolated from the screen of a cable distribution system.</p> <p>It is however accepted to provide the insulation external to the equipment by an adapter or an interconnection cable with galvanic isolator, which may be provided by e.g. a retailer.</p> <p>The user manual shall then have the following or similar information in Norwegian and Swedish language respectively, depending on in what country the equipment is intended to be used in:</p> <p>"Equipment connected to the protective earthing of the building installation through the mains connection or through other equipment with a connection to protective earthing – and to a cable distribution system using coaxial cable, may in some circumstances create a fire hazard. Connection to a cable distribution system has therefore to be provided through a device providing electrical isolation below a certain frequency range (galvanic isolator, see EN 60728-11)."</p> | | N/A |

| IEC60950_1C - ATTACHMENT | | | |
|--------------------------|---|-----------------|---------|
| Clause | Requirement + Test | Result - Remark | Verdict |
| | <p>NOTE In Norway, due to regulation for installations of cable distribution systems, and in Sweden, a galvanic isolator shall provide electrical insulation below 5 MHz. The insulation shall withstand a dielectric strength of 1,5 kV r.m.s., 50 Hz or 60 Hz, for 1 min.</p> <p>Translation to Norwegian (the Swedish text will also be accepted in Norway):</p> <p>“Utstyr som er koplet til beskyttelsesjord via nettplugg og/eller via annet jordtilkoplede utstyr – og er tilkoplede et kabel-TV nett, kan forårsake brannfare. For å unngå dette skal det ved tilkopling av utstyret til kabel-TV nettet installeres en galvanisk isolator mellom utstyret og kabel- TV nettet.”</p> <p>Translation to Swedish:</p> <p>”Utrustning som är kopplad till skyddsjord via jordat vägguttag och/eller via annan utrustning och samtidigt är kopplad till kabel-TV nät kan i vissa fall medföra risk för brand. För att undvika detta skall vid anslutning av utrustningen till kabel-TV nät galvanisk isolator finnas mellan utrustningen och kabel-TV nätet.”</p> | | |
| 1.7.5 | <p>In Denmark, socket-outlets for providing power to other equipment shall be in accordance with the Heavy Current Regulations, Section 107-2-D1, Standard Sheet DK 1-3a, DK 1-5a or DK 1-7a, when used on Class I equipment. For STATIONARY EQUIPMENT the socket-outlet shall be in accordance with Standard Sheet DK 1-1b or DK 1-5a.</p> <p>For CLASS II EQUIPMENT the socket outlet shall be in accordance with Standard Sheet DKA 1-4a.</p> | | N/A |
| 2.2.4 | In Norway , for requirements see 1.7.2.1, 6.1.2.1 and 6.1.2.2 of this annex. | | N/A |
| 2.3.2 | In Finland, Norway and Sweden there are additional requirements for the insulation. See 6.1.2.1 and 6.1.2.2 of this annex. | | N/A |
| 2.3.4 | In Norway , for requirements see 1.7.2.1, 6.1.2.1 and 6.1.2.2 of this annex. | | N/A |
| 2.6.3.3 | In the United Kingdom , the current rating of the circuit shall be taken as 13 A, not 16 A. | | N/A |
| 2.7.1 | In the United Kingdom , to protect against excessive currents and short-circuits in the PRIMARY CIRCUIT of DIRECT PLUG-IN EQUIPMENT, tests according to 5.3 shall be conducted, using an external protective device rated 30 A or 32 A. If these tests fail, suitable protective devices shall be included as integral parts of the DIRECT PLUG-IN EQUIPMENT, so that the requirements of 5.3 are met. | | N/A |

| IEC60950_1C - ATTACHMENT | | | |
|--------------------------|--|-----------------|---------|
| Clause | Requirement + Test | Result - Remark | Verdict |
| 2.10.5.13 | In Finland, Norway and Sweden , there are additional requirements for the insulation, see 6.1.2.1 and 6.1.2.2 of this annex. | | N/A |
| 3.2.1.1 | <p>In Switzerland, supply cords of equipment having a RATED CURRENT not exceeding 10 A shall be provided with a plug complying with SEV 1011 or IEC 60884-1 and one of the following dimension sheets:</p> <p>SEV 6532-2.1991 Plug Type 15 3P+N+PE 250/400 V, 10 A</p> <p>SEV 6533-2.1991 Plug Type 11 L+N 250 V, 10 A</p> <p>SEV 6534-2.1991 Plug Type 12 L+N+PE 250 V, 10 A</p> <p>In general, EN 60309 applies for plugs for currents exceeding 10 A. However, a 16 A plug and socket-outlet system is being introduced in Switzerland, the plugs of which are according to the following dimension sheets, published in February 1998:</p> <p>SEV 5932-2.1998: Plug Type 25 , 3L+N+PE 230/400 V, 16 A</p> <p>SEV 5933-2.1998: Plug Type 21, L+N, 250 V, 16A</p> <p>SEV 5934-2.1998: Plug Type 23, L+N+PE 250 V,</p> | | N/A |
| 3.2.1.1 | <p>In Denmark, supply cords of single-phase equipment having a rated current not exceeding 13 A shall be provided with a plug according to the Heavy Current Regulations, Section 107-2-D1.</p> <p>CLASS I EQUIPMENT provided with socket-outlets with earth contacts or which are intended to be used in locations where protection against indirect contact is required according to the wiring rules shall be provided with a plug in accordance with standard sheet DK 2-1a or DK 2-5a.</p> <p>If poly-phase equipment and single-phase equipment having a RATED CURRENT exceeding 13 A is provided with a supply cord with a plug, this plug shall be in accordance with the Heavy Current Regulations, Section 107-2-D1 or EN 60309-2.</p> | | N/A |

| IEC60950_1C - ATTACHMENT | | | |
|--------------------------|--|-----------------|---------|
| Clause | Requirement + Test | Result - Remark | Verdict |
| 3.2.1.1 | <p>In Spain, supply cords of single-phase equipment having a rated current not exceeding 10 A shall be provided with a plug according to UNE 20315:1994.</p> <p>Supply cords of single-phase equipment having a rated current not exceeding 2,5 A shall be provided with a plug according to UNE-EN 50075:1993.</p> <p>CLASS I EQUIPMENT provided with socket-outlets with earth contacts or which are intended to be used in locations where protection against indirect contact is required according to the wiring rules, shall be provided with a plug in accordance with standard UNE 20315:1994.</p> <p>If poly-phase equipment is provided with a supply cord with a plug, this plug shall be in accordance with UNE-EN 60309-2.</p> | | N/A |
| 3.2.1.1 | <p>In the United Kingdom, apparatus which is fitted with a flexible cable or cord and is designed to be connected to a mains socket conforming to BS 1363 by means of that flexible cable or cord and plug, shall be fitted with a 'standard plug' in accordance with Statutory Instrument 1768:1994 - The Plugs and Sockets etc. (Safety) Regulations 1994, unless exempted by those regulations.</p> <p>NOTE 'Standard plug' is defined in SI 1768:1994 and essentially means an approved plug conforming to BS 1363 or an approved conversion plug.</p> | | N/A |
| 3.2.1.1 | <p>In Ireland, apparatus which is fitted with a flexible cable or cord and is designed to be connected to a mains socket conforming to I.S. 411 by means of that flexible cable or cord and plug, shall be fitted with a 13 A plug in accordance with Statutory Instrument 525:1997 - National Standards Authority of Ireland (section 28) (13 A Plugs and Conversion Adaptors for Domestic Use) Regulations 1997.</p> | | N/A |
| 3.2.4 | <p>In Switzerland, for requirements see 3.2.1.1 of this annex.</p> | | N/A |
| 3.2.5.1 | <p>In the United Kingdom, a power supply cord with conductor of 1,25 mm² is allowed for equipment with a rated current over 10 A and up to and including 13 A.</p> | | N/A |
| 3.3.4 | <p>In the United Kingdom, the range of conductor sizes of flexible cords to be accepted by terminals for equipment with a RATED CURRENT of over 10 A up to and including 13 A is:</p> <ul style="list-style-type: none"> • 1,25 mm² to 1,5 mm² nominal cross-sectional area. | | N/A |

| IEC60950_1C - ATTACHMENT | | | |
|--------------------------|---|-----------------|---------|
| Clause | Requirement + Test | Result - Remark | Verdict |
| 4.3.6 | In the United Kingdom , the torque test is performed using a socket outlet complying with BS 1363 part 1:1995, including Amendment 1:1997 and Amendment 2:2003 and the plug part of DIRECT PLUG-IN EQUIPMENT shall be assessed to BS 1363: Part 1, 12.1, 12.2, 12.3, 12.9, 12.11, 12.12, 12.13, 12.16 and 12.17, except that the test of 12.17 is performed at not less than 125 °C. Where the metal earth pin is replaced by an Insulated Shutter Opening Device (ISOD), the requirements of clauses 22.2 and 23 also apply. | | N/A |
| 4.3.6 | In Ireland , DIRECT PLUG-IN EQUIPMENT is known as plug similar devices. Such devices shall comply with Statutory Instrument 526:1997 - National Standards Authority of Ireland (Section 28) (Electrical plugs, plug similar devices and sockets for domestic use) Regulations, 1997. | | N/A |
| 5.1.7.1 | In Finland, Norway and Sweden TOUCH CURRENT measurement results exceeding 3,5 mA r.m.s. are permitted only for the following equipment: <ul style="list-style-type: none"> • STATIONARY PLUGGABLE EQUIPMENT TYPE A that <ul style="list-style-type: none"> is intended to be used in a RESTRICTED ACCESS LOCATION where equipotential bonding has been applied, for example, in a telecommunication centre; and has provision for a permanently connected PROTECTIVE EARTHING CONDUCTOR; and is provided with instructions for the installation of that conductor by a SERVICE PERSON; • STATIONARY PLUGGABLE EQUIPMENT TYPE B; • STATIONARY PERMANENTLY CONNECTED EQUIPMENT. | | N/A |

| IEC60950_1C - ATTACHMENT | | | |
|--------------------------|--|-----------------|---------|
| Clause | Requirement + Test | Result - Remark | Verdict |
| 6.1.2.1 (A1:2010) | <p>In Finland, Norway and Sweden, add the following text between the first and second paragraph of the compliance clause:</p> <p>If this insulation is solid, including insulation forming part of a component, it shall at least consist of either</p> <ul style="list-style-type: none"> - two layers of thin sheet material, each of which shall pass the electric strength test below, or - one layer having a distance through insulation of at least 0,4 mm, which shall pass the electric strength test below. <p>Alternatively for components, there is no distance through insulation requirements for the insulation consisting of an insulating compound completely filling the casing, so that CLEARANCES and CREEPAGE DISTANCES do not exist, if the component passes the electric strength test in accordance with the compliance clause below and in addition</p> <ul style="list-style-type: none"> - passes the tests and inspection criteria of 2.10.11 with an electric strength test of 1,5 kV multiplied by 1,6 (the electric strength test of 2.10.10 shall be performed using 1,5 kV), and - is subject to ROUTINE TESTING for electric strength during manufacturing, using a test voltage of 1,5 kV. | | N/A |
| | <p>It is permitted to bridge this insulation with an optocoupler complying with 2.10.5.4 b).</p> <p>It is permitted to bridge this insulation with a capacitor complying with EN 60384-14:2005, subclass Y2.</p> <p>A capacitor classified Y3 according to EN 60384-14:2005, may bridge this insulation under the following conditions:</p> <ul style="list-style-type: none"> - the insulation requirements are satisfied by having a capacitor classified Y3 as defined by EN 60384-14, which in addition to the Y3 testing, is tested with an impulse test of 2,5 kV defined in EN 60950-1:2006, 6.2.2.1; - the additional testing shall be performed on all the test specimens as described in EN 60384-14; - the impulse test of 2,5 kV is to be performed before the endurance test in EN 60384-14, in the sequence of tests as described in EN 60384-14. | | N/A |

| IEC60950_1C - ATTACHMENT | | | |
|--------------------------|---|-----------------|------------|
| Clause | Requirement + Test | Result - Remark | Verdict |
| 6.1.2.2 | In Finland, Norway and Sweden , the exclusions are applicable for PERMANENTLY CONNECTED EQUIPMENT, PLUGGABLE EQUIPMENT TYPE B and equipment intended to be used in a RESTRICTED ACCESS LOCATION where equipotential bonding has been applied, e.g. in a telecommunication centre, and which has provision for a permanently connected PROTECTIVE EARTHING CONDUCTOR and is provided with instructions for the installation of that conductor by a SERVICE PERSON. | | N/A |
| 7.2 | In Finland, Norway and Sweden , for requirements see 6.1.2.1 and 6.1.2.2 of this annex. The term TELECOMMUNICATION NETWORK in 6.1.2 being replaced by the term CABLE DISTRIBUTION SYSTEM. | | N/A |
| 7.3 | In Norway and Sweden , for requirements see 1.2.13.14 and 1.7.2.1 of this annex. | | N/A |
| 7.3 | In Norway , for installation conditions see EN 60728-11:2005. | | N/A |

| IEC60950_1C - ATTACHMENT | | | |
|--------------------------|--------------------|-----------------|---------|
| Clause | Requirement + Test | Result - Remark | Verdict |

| | | | |
|---|--|-------------------------------|--|
| ATTACHMENT TO TEST REPORT IEC 60950-1 CANADA NATIONAL DIFFERENCES Information technology equipment – Safety – Part 1: General requirements | | | |
| Differences according to: | | CAN/CSA-C22.2 NO. 60950-1A-07 | |
| Attachment Form No.: | | CA_ND_IEC60950_1C | |
| Attachment Originator | | TÜV SÜD Product Service GmbH | |
| Master Attachment | | Date (2012-08) | |
| Copyright © 2012 IEC System for Conformity Testing and Certification of Electrical Equipment (IECEE), Geneva, Switzerland. All rights reserved. | | | |

| | Special national conditions | | |
|--------|--|---|------------|
| 1.1.1 | All equipment is to be designed to allow installation in accordance with the National Electrical Code (NEC), ANSI/NFPA 70, the Canadian Electrical Code (CEC), Part I, CAN/CSA C22.1, and when applicable, the National Electrical Safety Code, IEEE C2. | In accordance with the National Electrical Code (NEC), ANSI/NFPA 70, and unless marked or otherwise identified, the Standard for Electronic Computer/Data-Processing Equipment, ANSI/NFPA 75. | P |
| | Also, unless marked or otherwise identified, installation is allowed per the Standard for the Protection of Electronic Computer/Data-Processing Equipment, ANSI/NFPA 75. | | P |
| 1.4.14 | For Pluggable Equipment Type A, the protection in the installation is assumed to be 20A. | | N/A |
| 1.5.5 | For lengths exceeding 3.05 m, external interconnecting flexible cord and cable assemblies are required to be a suitable cable type (e.g., DP, CL2) specified in the CEC/NEC. | No external cable provided. | N/A |
| | For lengths 3.05 m or less, external interconnecting flexible cord and cable assemblies that are not types specified in the CEC are required to have special construction features and identification markings. | | N/A |
| 1.7.1 | Equipment for use on a.c. mains supply systems with a neutral and more than one phase conductor (e.g. 120/240 V, 3-wire) require a special marking format for electrical ratings. | | N/A |
| | A voltage rating that exceeds an attachment plug cap rating is only permitted if it does not exceed the extreme operating conditions in Table 2 of CAN/CSA C22.2 No. 235, and | | N/A |
| | - if it is part of a range that extends into the Table 2 "Normal Operating Conditions." | | N/A |

| IEC60950_1C - ATTACHMENT | | | |
|--------------------------|---|---|---------|
| Clause | Requirement + Test | Result - Remark | Verdict |
| | A voltage rating is not be lower than the specified "Normal Operating Conditions," unless it is part of a range that extends into the "Normal Operating Conditions." | | N/A |
| 1.7.7 | Wiring terminals intended to supply Class 2 outputs in accordance with CEC Part 1 or NEC are marked with the voltage rating and "Class 2" or equivalent. | No wiring terminals. | N/A |
| | - Marking is located adjacent to the terminals | | N/A |
| | - Marking is visible during wiring | | N/A |
| 2.5 | Fuse providing Class 2, Limited Power Source, or TNV current limiting is not operator-accessible unless it is not interchangeable. | | N/A |
| 2.6.3.3 | Modify first column on Table 2D to "Smaller of the RATED CURRENT of the equipment or the PROTECTIVE CURRENT RATING of the circuit under consideration." | | N/A |
| 2.7.1 | Suitable NEC/CEC branch circuit protection rated at the maximum circuit rating is provided for all standard supply outlets and receptacles (such as supplied in power distribution units) if the supply branch circuit protection is not suitable. | No such components provided. | N/A |
| | Power distribution transformers distributing power at 100 volts or more, and rated 10 kVA or more, provided with special transformer overcurrent protection. | | N/A |
| 3.2 | Wiring methods (terminals, leads, etc.) used for the connection of the equipment to the mains is in accordance with the NEC/CEC. | | N/A |
| 3.2.1 | Attachment plugs of power supply cords are rated not less than 125 percent of the rated current of the equipment. | No power supply cord provided. | N/A |
| 3.2.1.2 | Equipment connected to a centralized d.c. power system, and having one pole of the DC mains input terminal connected to the main protective earthing terminal in the equipment comply with special earthing, wiring, marking and installation instruction requirements. | No connection to a centralized d.c. power system. | N/A |
| 3.2.3 | Permanent connection of equipment to the mains supply by a power supply cord is not permitted, except for certain equipment, such as ATMs. | No connection to mains. | N/A |
| 3.2.5 | Power supply cords are no longer than 4.5 m in length. | No power supply cord provided. | N/A |
| | Minimum cord length is 1.5 m, with certain constructions such as external power supplies allowed to consider both input and output cord lengths into the requirement. | | N/A |

| IEC60950_1C - ATTACHMENT | | | |
|--------------------------|---|---------------------------------|---------|
| Clause | Requirement + Test | Result - Remark | Verdict |
| | Flexible power supply cords are compatible with Article 400 of the NEC, and Tables 11 and 12 of the CEC. | | N/A |
| 3.2.9 | Permanently connected equipment have a suitable wiring compartment and wire bending space. | No connection to mains. | N/A |
| 3.3 | Wiring terminals and associated spacings for field wiring connections comply with CSA C22.2 No. 0. | No wiring terminals. | N/A |
| 3.3.3 | Wire binding screws are not permitted to attach conductors larger than 10 AWG (5.3 mm ²). | No wire binding screws. | N/A |
| 3.3.4 | Terminals for permanent wiring, including protective earthing terminals, are suitable for Canadian/US wire gauge sizes, are | No connection to mains. | N/A |
| | - rated 125 percent of the equipment rating, and | | N/A |
| | - are specially marked when specified (1.7.7). | | N/A |
| 3.3.5 | Revise first column of Table 3E to "Smaller of the RATED CURRENT of the equipment or the PROTECTIVE CURRENT RATING of the circuit under consideration." | | N/A |
| 3.4.2 | Motor control devices are provided for cord-connected equipment with a motor if the equipment is rated more than 12 A, | Equipment is not such a device. | N/A |
| | - or if the motor has a nominal voltage rating greater than 120 V | | N/A |
| | - or is rated more than 1/3 hp (locked rotor current over 43 A) | | N/A |
| 3.4.8 | Vertically-mounted disconnect switches and circuit breakers have the "on" position indicated by the handle in the up position. | No such devices incorporated. | N/A |
| 3.4.11 | For computer room applications, equipment with battery systems capable of supplying 750 VA for five minutes have a battery disconnect means that may be connected to the computer room remote power-off circuit. | Not such an application. | N/A |
| 4.3.12 | The maximum quantity of flammable liquid stored in equipment complies with NFPA 30. | No liquids. | N/A |
| 4.3.13.5 | Equipment with lasers meet the Canadian Radiation Emitting Devices Act, REDR C1370 and/or Code of Federal Regulations 21 CFR 1040, as applicable. | No lasers. | N/A |
| 4.7 | For computer room applications, automated information storage systems with combustible media greater than 0.76 m ³ (27 cu ft) have a provision for connection of either automatic sprinklers or a gaseous agent extinguishing system with an extended discharge. | Not such an application. | N/A |

| IEC60950_1C - ATTACHMENT | | | |
|-----------------------------------|---|---------------------------------|---------|
| Clause | Requirement + Test | Result - Remark | Verdict |
| 4.7.3.1 | For computer room applications, enclosures with combustible material measuring greater than 0.9 m ² (10 sq ft) or a single dimension greater than 1.8 m (6 ft) have a flame spread rating of 50 or less. | Not such an application. | N/A |
| | For other applications, enclosures with the same dimensions require a flame spread rating of 200 or less. | | N/A |
| Annex H | Equipment that produces ionizing radiation comply with the Canadian Radiation Emitting Devices Act, REDR C1370 and/or Code of Federal Regulations, 21 CFR 1020, as applicable. | Equipment is not such a device. | N/A |
| Other National Differences | | | |
| 1.5.1 | Some components and materials associated with the risk of fire, electric shock, or personal injury have component or material ratings in accordance with the applicable national (Canadian and/or U.S.) component or material standard requirements. | Complied. See table 1.5.1 | P |
| 1.6.1.2 | A circuit for connection to the DC Mains Supply is classified as either a SELV Circuit, TNV-2 Circuit or Hazardous Voltage Circuit depending on the maximum operating voltage of the supply. | No connection to mains. | N/A |
| | This maximum operating voltage includes consideration of the battery charging "float voltage" associated with the intended supply system, regardless of the marked power rating of the equipment. | | N/A |
| 2.3.1 | For TNV-2 and TNV-3 circuits with other than ringing signals and with voltages exceeding 42.4 V _{peak} or 60 V _{d.c.} , the maximum acceptable current through a 2000 ohm resistor (or greater) connected across the voltage source with other loads disconnected is 7.1 mA peak or 30 mA d.c. under normal operating conditions. | No TNV circuits. | N/A |
| 2.3.2.1 | In the event of a single fault between TNV and SELV circuits, the limits of 2.2.3 apply to SELV Circuits and accessible conductive parts. | No TNV circuits. | N/A |
| 2.6.3.4 | Protective bonding conductors of non-standard protective bonding constructions (e.g., printed circuit traces) may be subjected to the additional limited short circuit test conditions specified. | | P |
| 4.2.8.1 | Enclosures around CRTs with a face diameter of 160 mm or more reduce the risk of injury due to the implosion of the CRT. | No CRTs. | N/A |
| 4.3.2 | Equipment with handles complies with special loading tests. | No handles. | N/A |
| 5.1.8.3 | Equipment intended to receive telecommunication ringing signals comply with a special touch current measurement tests. | No TNV | N/A |

| IEC60950_1C - ATTACHMENT | | | |
|--------------------------|---|---------------------------------|------------|
| Clause | Requirement + Test | Result - Remark | Verdict |
| 5.3.7 | Internal (e.g., card cage) SELV circuit connectors and printed wiring board connectors that are accessible to the operator and that deliver power are overloaded. | | N/A |
| | During abnormal operating testing, if a circuit is interrupted by the opening of a component, the test shall be repeated twice (three tests total) using new components as necessary | | N/A |
| 6.4 | Equipment intended for connection to telecommunication network outside plant cable is protected against overvoltage from power line crosses in accordance with 6.4 and Annex NAC. | No TNV. | N/A |
| Annex EE | Articulated accessibility probe (Fig EE.3) is used for assessing accessibility to document/media shredders instead of the Figure 2A test finger. | Equipment is not such a device. | N/A |
| M.2 | Continuous ringing signals up to 16 mA only are permitted if the equipment is subjected to special installation and performance restrictions. | No TNV. | N/A |
| Annex NAD | Equipment connected to a telecommunication and cable distribution networks and supplied with an earphone intended to be held against, or in the ear comply with special acoustic pressure requirements. | No TNV. | N/A |

| IEC60950_1C - ATTACHMENT | | | |
|--------------------------|--------------------|-----------------|---------|
| Clause | Requirement + Test | Result - Remark | Verdict |

| | | | |
|--|--|--|--|
| ATTACHMENT TO TEST REPORT IEC 60950-1 FINLAND NATIONAL DIFFERENCES Information technology equipment – Safety – Part 1: General requirements | | | |
| Differences according to: EN 60950-1:2006/A11:2009/A1:2010 | | | |
| Attachment Form No.: FI_ND_IEC60950_1C | | | |
| Attachment Originator: SGS Fimko Ltd | | | |
| Master Attachment: Date (2010-04) | | | |
| Copyright © 2010 IEC System for Conformity Testing and Certification of Electrical Equipment (IECEE), Geneva, Switzerland. All rights reserved. | | | |

| | National Differences | | |
|----------------|--|-----------------------|------------|
| General | See also Group Differences (EN 60950-1:2006/A11/A1) | | |
| 1.5.7.1 | In Finland resistors bridging BASIC INSULATION in CLASS I PLUGGABLE EQUIPMENT TYPE A must comply with the requirements in 1.5.7.1. In addition when a single resistor is used, the resistor must withstand the resistor test in 1.5.7.2. | | N/A |
| 1.5.9.4 | In Finland , the third dashed sentence is applicable only to equipment as defined in 6.1.2.2 of this annex. | No such construction. | N/A |
| 1.7.2.1 | In Finland , CLASS I PLUGGABLE EQUIPMENT TYPE A intended for connection to other equipment or a network shall, if safety relies on connection to protective earth or if surge suppressors are connected between the network terminals and accessible parts, have a marking stating that the equipment must be connected to an earthed mains socket-outlet. The marking text in in Finland shall be as follows: "Laite on liitettävä suojakoskettimilla varustettuun pistorasiaan" | | N/A |
| 2.3.2 | In Finland , there are additional requirements for the insulation. See 6.1.2.1 and 6.1.2.2 of this annex. | No TNV. | N/A |
| 2.10.5.13 | In Finland , there are additional requirements for the insulation, see 6.1.2.1 and 6.1.2.2 of this annex. | No TNV. | N/A |

| IEC60950_1C - ATTACHMENT | | | |
|--------------------------|--|-----------------|------------|
| Clause | Requirement + Test | Result - Remark | Verdict |
| 5.1.7.1 | <p>In Finland, TOUCH CURRENT measurement results exceeding 3,5 mA r.m.s. are permitted only for the following equipment:</p> <ul style="list-style-type: none"> • STATIONARY PLUGGABLE EQUIPMENT TYPE A that <ul style="list-style-type: none"> - is intended to be used in a RESTRICTED ACCESS LOCATION where equipotential bonding has been applied, for example, in a telecommunication centre; and - has provision for a permanently connected PROTECTIVE EARTHING CONDUCTOR; and - is provided with instructions for the installation of that conductor by a SERVICE PERSON; • STATIONARY PLUGGABLE EQUIPMENT TYPE B; • STATIONARY PERMANENTLY CONNECTED EQUIPMENT. | | N/A |
| 6.1.2.1 (A1:2010) | <p>In Finland, add the following text between the first and second paragraph of the compliance clause:</p> <p>If this insulation is solid, including insulation forming part of a component, it shall at least consist of either</p> <ul style="list-style-type: none"> - two layers of thin sheet material, each of which shall pass the electric strength test below, or - one layer having a distance through insulation of at least 0,4 mm, which shall pass the electric strength test below. <p>Alternatively for components, there is no distance through insulation requirement for the insulation consisting of an insulating compound completely filling the casing, so that CLEARANCES and CREEPAGE DISTANCES do not exist, if the component passes the electric strength test in accordance with the compliance clause below and in addition</p> <ul style="list-style-type: none"> - passes the tests and inspection criteria of 2.10.11 with an electric strength test of 1,5 kV multiplied by 1,6 (the electric strength test of 2.10.10 shall be performed using 1,5 kV), and - is subject to ROUTINE TESTING for electric strength during manufacturing, using a test voltage of 1,5 kV. | No TNV. | N/A |

| IEC60950_1C - ATTACHMENT | | | |
|--------------------------|---|---|------------|
| Clause | Requirement + Test | Result - Remark | Verdict |
| | <p>It is permitted to bridge this insulation with an optocoupler complying with 2.10.5.4 b).</p> <p>It is permitted to bridge this insulation with a capacitor complying with EN 60384-14:2005, subclass Y2.</p> <p>A capacitor classified Y3 according to EN 60384-14:2005, may bridge this insulation under the following conditions:</p> <ul style="list-style-type: none"> - the insulation requirements are satisfied by having a capacitor classified Y3 as defined by EN 60384-14:2005 which in addition to the Y3 testing, is tested with an impulse test of 2,5 kV defined in EN 60950-1:2006, 6.2.2.1; - the additional testing shall be performed on all the test specimens as described in EN 60384-14:2005; - the impulse test of 2,5 kV is to be performed before the endurance test in EN 60384-14:2005, in the sequence of tests as described in EN 60384-14:2005. | | |
| 6.1.2.2 | <p>In Finland, the exclusions are applicable for PERMANENTLY CONNECTED EQUIPMENT, PLUGGABLE EQUIPMENT TYPE B and equipment intended to be used in a RESTRICTED ACCESS LOCATION where equipotential bonding has been applied, e.g. in a telecommunication centre, and which has provision for a permanently connected PROTECTIVE EARTHING CONDUCTOR and is provided with instructions for the installation of that conductor by a SERVICE PERSON.</p> | No TNV. | N/A |
| 7.2 | <p>In Finland, for requirements see 6.1.2.1 and 6.1.2.2 of this annex.</p> <p>The term TELECOMMUNICATION NETWORK in 6.1.2 being replaced by the term CABLE DISTRIBUTION SYSTEM.</p> | Not connected to cable distribution system. | N/A |

| IEC60950_1C - ATTACHMENT | | | |
|--------------------------|--------------------|-----------------|---------|
| Clause | Requirement + Test | Result - Remark | Verdict |

| | | | |
|---|--|--|--|
| <p>ATTACHMENT TO TEST REPORT IEC 60950-1 GERMANY NATIONAL DIFFERENCES Information technology equipment – Safety – Part 1: General requirements</p> | | | |
| Differences according to.....: VDE 0805-1:2011-01 | | | |

| | | | |
|----------------------|--|--|------------|
| Annex ZC, 1.7.2.1 | According to GPSG, section 2, clause 4: If certain rules on the use, supplementation or maintenance of an item of technical work equipment or ready-to-use commodity must be observed in order to guarantee safety and health, instructions for use in German must be supplied when it is brought into circulation. | | N/A |
|----------------------|--|--|------------|

| IEC60950_1C - ATTACHMENT | | | |
|---|--------------------|-----------------|---------|
| Clause | Requirement + Test | Result - Remark | Verdict |
| ATTACHMENT TO TEST REPORT IEC 60950-1 ISRAEL NATIONAL DIFFERENCES Information technology equipment – Safety – Part 1: General requirements | | | |
| Differences according to.....: SI 60950 Part 1 | | | |

| | | | |
|---------|---|-----------|------------|
| 1.1.1 | Replace the the text of Note 3 as follows: The requirements of Israel Standard SI 60065 may also be used to meet safety requirements for multimedia equipment. See IEC Guide 112, Guide on the safety of multimedia equipment. | Replaced. | P |
| 1.6 | The clause is applicable with the following addition: | | N/A |
| 1.6.1 | Add following note: In Israel, this clause is applicable subject to the Electricity Law, 1954, its regulations and revisions. | Added | N/A |
| 1.7 | The clause is applicable with the following additions: Subclause 1.7.201 shall be added at the beginning of the clause as follows: | Added | N/A |
| 1.7.201 | Marking in the Hebrew language The marking in the Hebrew language shall be in accordance with the Consumer Protection Order (Marking of goods), 1983. In addition to the marking required by clause 1.7.1, the following details shall be marked in the Hebrew language. The details shall be marked on the apparatus or on its package, or on a label properly attached to the apparatus or on the package, by bonding or sewing, in a manner that the label cannot be easily removed. 1. Name of the apparatus and it commercial designation; 2. Manufacturer's name and address. If the apparatus is imported, the importer's name and address; 3. Manufacturer's registered trademark, if any; 4. Name of the model and serial number, if any; 5. Country of manufacture. | | N/A |
| 1.7.2.1 | The following shall be added to the clause: All the instructions and warnings related to safety shall also be written in the Hebrew language. | Added | N/A |
| 2 | The clause is applicable with the following additions: | | P |

| IEC60950_1C - ATTACHMENT | | | |
|--------------------------|---|-------------------------|------------|
| Clause | Requirement + Test | Result - Remark | Verdict |
| 2.9.4 | <p>The following shall be added at the beginning of the clause:</p> <p>In Israel, according to the Electricity Law, 1954, and the Electricity Regulations (Earthing and means of protection against electricity of voltages up to 1,000V) 1991, seven means of protection against electrocution are permitted, as follows:</p> <ol style="list-style-type: none"> 1) TN-S - Network system earthing; TN-C-S - Network system earthing; 2) TT - Network system earthing; 3) IT - Network Insulation Terre; 4) Isolated transformer; 5) Safety extra low voltage (SELV or ELV); 6) Residual current circuit breaker (30 mA = IΔ); 7) Reinforced insulation; Double insulation (class II) | Added. | N/A |
| 2.201 | <p>Prevention of electromagnetic interference</p> <p>- Prior to carrying out the tests in accordance with the clauses of this Standard, the compliance of the apparatus with the relevant requirements specified in the appropriate part of the Standard series, SI 961, shall be checked.</p> <p><u>The apparatus shall meet the requirements in the appropriate part of the Standard series, SI 961.</u></p> <p>- If there are components in the apparatus for the prevention of electromagnetic interference, these components shall not reduce the safety level of the apparatus as required by this Standard.</p> | | N/A |
| 3 | The clause is applicable with the following additions: | | |
| 3.2.1.1 | <p>Connection to an a.c. mains supply</p> <p>After the note, the following note shall be added:</p> <p>Note:</p> <p>In Israel, the feed plug shall comply with the requirements of Israel Standard SI 32 Part 1.1.</p> | No feed plug provided. | N/A |
| 3.2.1.2 | <p>Connection to a d.c. mains supply</p> <p>At the end of the first paragraph, the following note shall be added:</p> <p>Note:</p> <p>At the time of issue of this Standard, there is no Israel Standard for connection accessories to d.c.</p> | No connection to mains. | N/A |
| Annex P | <p>Normative references</p> <p>(List of relevant Israel Standards that have been inserted in place of some of the International Standards)</p> | Inserted | P |

| IEC60950_1C - ATTACHMENT | | | |
|--------------------------|--------------------|-----------------|---------|
| Clause | Requirement + Test | Result - Remark | Verdict |

| |
|---|
| <p>ATTACHMENT TO TEST REPORT IEC 60950-1 KOREA NATIONAL DIFFERENCES Information technology equipment – Safety – Part 1: General requirements</p> |
| <p>Differences according to.....: K 60950-1</p> |

| | | | |
|---------|---|--------------------------------|------------|
| 1.5.101 | Plugs for the connection of the apparatus to the supply mains shall comply with the Korean requirement (KSC 8305) | No power supply cord provided. | N/A |
| 8 | EMC The apparatus shall comply with the relevant CISPR standards. | | N/A |

| IEC60950_1C - ATTACHMENT | | | |
|--------------------------|--------------------|-----------------|---------|
| Clause | Requirement + Test | Result - Remark | Verdict |

| | | | |
|---|--|--|--|
| ATTACHMENT TO TEST REPORT IEC 60950-1 U.S.A. NATIONAL DIFFERENCES Information technology equipment – Safety – Part 1: General requirements | | | |
| Differences according to: UL 60950-1-07 | | | |
| Attachment Form No.: US_ND_IEC60950_1C | | | |
| Attachment Originator: TÜV SÜD Product Service GmbH | | | |
| Master Attachment: Date (2012-08) | | | |
| Copyright © 2012 IEC System for Conformity Testing and Certification of Electrical Equipment (IECEE), Geneva, Switzerland. All rights reserved. | | | |

| | Special national conditions | | |
|--------|--|---|------------|
| 1.1.1 | All equipment is to be designed to allow installation in accordance with the National Electrical Code (NEC), ANSI/NFPA 70, the Canadian Electrical Code (CEC), Part I, CAN/CSA C22.1, and when applicable, the National Electrical Safety Code, IEEE C2. | In accordance with the National Electrical Code (NEC), ANSI/NFPA 70, and unless marked or otherwise identified, the Standard for Electronic Computer/Data-Processing Equipment, ANSI/NFPA 75. | P |
| | Also, unless marked or otherwise identified, installation is allowed per the Standard for the Protection of Electronic Computer/Data-Processing Equipment, ANSI/NFPA 75. | | P |
| 1.4.14 | For Pluggable Equipment Type A, the protection in the installation is assumed to be 20A. | | N/A |
| 1.5.5 | For lengths exceeding 3.05 m, external interconnecting flexible cord and cable assemblies are required to be a suitable cable type (e.g., DP, CL2) specified in the CEC/NEC. | No external cable provided. | N/A |
| | For lengths 3.05 m or less, external interconnecting flexible cord and cable assemblies that are not types specified in the CEC are required to have special construction features and identification markings. | | N/A |
| 1.7.1 | Equipment for use on a.c. mains supply systems with a neutral and more than one phase conductor (e.g. 120/240 V, 3-wire) require a special marking format for electrical ratings. | | N/A |
| | A voltage rating that exceeds an attachment plug cap rating is only permitted if it does not exceed the extreme operating conditions in Table 2 of CAN/CSA C22.2 No. 235, and | | N/A |

| IEC60950_1C - ATTACHMENT | | | |
|--------------------------|---|---|---------|
| Clause | Requirement + Test | Result - Remark | Verdict |
| | - if it is part of a range that extends into the Table 2 "Normal Operating Conditions." | | N/A |
| | A voltage rating is not to be lower than the specified "Normal Operating Conditions," unless it is part of a range that extends into the "Normal Operating Conditions." | | N/A |
| 1.7.7 | Wiring terminals intended to supply Class 2 outputs in accordance with CEC Part 1 or NEC are marked with the voltage rating and "Class 2" or equivalent. | No wiring terminals. | N/A |
| | - Marking is located adjacent to the terminals | | N/A |
| | - Marking is visible during wiring | | N/A |
| 2.5 | Fuse providing Class 2, Limited Power Source, or TNV current limiting is not operator-accessible unless it is not interchangeable. | | N/A |
| 2.6.3.3 | Modify first column on Table 2D to "Smaller of the RATED CURRENT of the equipment or the PROTECTIVE CURRENT RATING of the circuit under consideration." | | N/A |
| 2.7.1 | Suitable NEC/CEC branch circuit protection rated at the maximum circuit rating is provided for all standard supply outlets and receptacles (such as supplied in power distribution units) if the supply branch circuit protection is not suitable. | No such components provided. | N/A |
| | Power distribution transformers distributing power at 100 volts or more, and rated 10 kVA or more, provided with special transformer overcurrent protection. | | N/A |
| 3.2 | Wiring methods (terminals, leads, etc.) used for the connection of the equipment to the mains is in accordance with the NEC/CEC. | | N/A |
| 3.2.1 | Attachment plugs of power supply cords are rated not less than 125 per cent of the rated current of the equipment. | | N/A |
| 3.2.1.2 | Equipment connected to a centralized d.c. power system, and having one pole of the DC mains input terminal connected to the main protective earthing terminal in the equipment comply with special earthing, wiring, marking and installation instruction requirements. | No power supply cord provided. | N/A |
| 3.2.3 | Permanent connection of equipment to the mains supply by a power supply cord is not permitted, except for certain equipment, such as ATMs. | No connection to a centralized d.c. power system. | N/A |
| 3.2.5 | Power supply cords are no longer than 4.5 m in length. | | N/A |

| IEC60950_1C - ATTACHMENT | | | |
|--------------------------|--|---------------------------------|---------|
| Clause | Requirement + Test | Result - Remark | Verdict |
| | Minimum cord length is 1.5 m, with certain constructions such as external power supplies allowed to consider both input and output cord lengths into the requirement. | | N/A |
| | Flexible power supply cords are compatible with Article 400 of the NEC, and Tables 11 and 12 of the CEC. | | N/A |
| 3.2.9 | Permanently connected equipment have a suitable wiring compartment and wire bending space. | | N/A |
| 3.3 | Wiring terminals and associated spacings for field wiring connections comply with CSA C22.2 No. 0. | No wiring terminals. | N/A |
| 3.3.3 | Wire binding screws are not permitted to attach conductors larger than 10 AWG (5.3 mm ²). | No wire binding screws. | N/A |
| 3.3.4 | Terminals for permanent wiring, including protective earthing terminals, are suitable for Canadian/US wire gauge sizes, are | | N/A |
| | - rated 125 per cent of the equipment rating, and | | N/A |
| | - are specially marked when specified (1.7.7). | | N/A |
| 3.3.5 | Revise first column of Table 3E to "Smaller of the RATED CURRENT of the equipment or the PROTECTIVE CURRENT RATING of the circuit under consideration." | | N/A |
| 3.4.2 | Motor control devices are provided for cord-connected equipment with a motor if the equipment is rated more than 12 A, | Equipment is not such a device. | N/A |
| | - or if the motor has a nominal voltage rating greater than 120 V | | N/A |
| | - or is rated more than 1/3 hp (locked rotor current over 43 A) | | N/A |
| 3.4.8 | Vertically-mounted disconnect switches and circuit breakers have the "on" position indicated by the handle in the up position. | No such devices incorporated. | N/A |
| 3.4.11 | For computer room applications, equipment with battery systems capable of supplying 750 VA for five minutes have a battery disconnect means that may be connected to the computer room remote power-off circuit. | Not such an application. | N/A |
| 4.3.12 | The maximum quantity of flammable liquid stored in equipment complies with NFPA 30. | No liquids. | N/A |
| 4.3.13.5 | Equipment with lasers meet the Canadian Radiation Emitting Devices Act, REDR C1370 and/or Code of Federal Regulations 21 CFR 1040, as applicable. | No lasers. | N/A |

| IEC60950_1C - ATTACHMENT | | | |
|--------------------------|---|---------------------------------------|---------|
| Clause | Requirement + Test | Result - Remark | Verdict |
| 4.7 | For computer room applications, automated information storage systems with combustible media greater than 0.76 m ³ (27 cu ft) have a provision for connection of either automatic sprinklers or a gaseous agent extinguishing system with an extended discharge. | Not such an application. | N/A |
| 4.7.3.1 | For computer room applications, enclosures with combustible material measuring greater than 0.9 m ² (10 sq ft) or a single dimension greater than 1.8 m (6 ft) have a flame spread rating of 50 or less. | Not such an application. | N/A |
| | For other applications, enclosures with the same dimensions require a flame spread rating of 200 or less. | | N/A |
| Annex H | Equipment that produces ionizing radiation complies with U.S. Code of Federal Regulations, 21 CFR 1020 (and the Canadian Radiation Emitting Devices Act, REDR C1370). | Equipment is not such a device. | N/A |
| | Other National Differences | | |
| 1.5.1 | Some components and materials associated with the risk of fire, electric shock, or personal injury have component or material ratings in accordance with the applicable national (Canadian and/or U.S.) component or material standard requirements. | Complied. See table 1.5.1 | P |
| 1.6.1.2 | A circuit for connection to the DC Mains Supply is classified as either a SELV Circuit, TNV-2 Circuit or Hazardous Voltage Circuit depending on the maximum operating voltage of the supply. | No connection to the DC Mains Supply. | N/A |
| | This maximum operating voltage includes consideration of the battery charging "float voltage" associated with the intended supply system, regardless of the marked power rating of the equipment. | | N/A |
| 2.3.1 | For TNV-2 and TNV-3 circuits with other than ringing signals and with voltages exceeding 42.4 V _{peak} or 60 V _{d.c.} , the maximum acceptable current through a 2000 ohm resistor (or greater) connected across the voltage source with other loads disconnected is 7.1 mA peak or 30 mA d.c. under normal operating conditions. | No TNV circuits. | N/A |
| 2.3.2.1 | In the event of a single fault between TNV and SELV circuits, the limits of 2.2.3 apply to SELV Circuits and accessible conductive parts. | No TNV circuits. | N/A |
| 2.6.3.4 | Protective bonding conductors of non-standard protective bonding constructions (e.g., printed circuit traces) may be subjected to the additional limited short circuit test conditions specified. | | N/A |

| IEC60950_1C - ATTACHMENT | | | |
|--------------------------|---|-------------------------------|------------|
| Clause | Requirement + Test | Result - Remark | Verdict |
| 4.2.8.1 | Enclosures around CRTs with a face diameter of 160 mm or more reduce the risk of injury due to the implosion of the CRT. | No CRTs. | N/A |
| 4.3.2 | Equipment with handles complies with special loading tests. | No handles. | N/A |
| 5.1.8.3 | Equipment intended to receive telecommunication ringing signals comply with a special touch current measurement tests. | No TNV. | N/A |
| 5.3.7 | Internal (e.g., card cage) SELV circuit connectors and printed wiring board connectors that are accessible to the operator and that deliver power are overloaded. | | N/A |
| | During abnormal operating testing, if a circuit is interrupted by the opening of a component, the test shall be repeated twice (three tests total) using new components as necessary | | N/A |
| 6.4 | Equipment intended for connection to telecommunication network outside plant cable is protected against overvoltage from power line crosses in accordance with 6.4 and Annex NAC. | No TNV. | N/A |
| Annex EE | Articulated accessibility probe (Fig EE.3) is used for assessing accessibility to document/media shredders instead of the Figure 2A test finger. | No document (paper) shredder. | N/A |
| Annex M.2 | Continuous ringing signals up to 16 mA only are permitted if the equipment is subjected to special installation and performance restrictions. | No TNV. | N/A |
| Annex NAD | Equipment connected to a telecommunication and cable distribution networks and supplied with an earphone intended to be held against, or in the ear comply with special acoustic pressure requirements. | No TNV. | N/A |

| IEC60950_1C - ATTACHMENT | | | |
|--------------------------|--------------------|-----------------|---------|
| Clause | Requirement + Test | Result - Remark | Verdict |

| |
|---|
| <p>ATTACHMENT TO TEST REPORT IEC 60950-1 AUSTRALIA and NEW ZEALAND NATIONAL DIFFERENCES Information technology equipment – Safety – Part 1: General requirements</p> |
| <p>Differences according to.....: AS/NZS 60950.1:2011</p> |

| | | | |
|------------|---|--------|------------|
| 1.2 | Insert the following between 'person, service' and 'range, rated frequency': POTENTIAL IGNITION SOURCE 1.2.12 | | N/A |
| 1.2.12.201 | Insert a new Clause 1.2.12.201 after Clause 1.2.12.15 as follows: 1.2.12.201 POTENTIAL IGNITION SOURCE Possible fault which can start a fire if the open-circuit voltage measured across an interruption or faulty contact exceeds a value of 50 V (peak) a.c. or d.c. and the product of the peak value of this voltage and the measured r.m.s. current under normal operating conditions exceeds 15 VA. Such a faulty contact or interruption in an electrical connection includes those which may occur in CONDUCTIVE PATTERNS on PRINTED BOARDS. NOTE 201 An electronic protection circuit may be used to prevent such a fault from becoming a POTENTIAL IGNITION SOURCE. NOTE 202 This definition is from AS/NZS 60065:2003. | | N/A |
| 1.5.1 | 1. Add the following to the end of the first paragraph: 'or the relevant Australian/New Zealand Standard.' 2. In NOTE 1, add the following after the word 'standard': 'or an Australian/New Zealand Standard' | Added. | P |
| 1.5.2 | Add the following to the end of the first and third dash items: 'or the relevant Australian/New Zealand Standard' | Added. | P |

| IEC60950_1C - ATTACHMENT | | | | | | | | | | | | | | | | | | | | |
|-------------------------------------|---|--|-------------------------|--|---|--|--------------------------------|------------------|----------|--------------------------------|------|----------|---------------------------------|--------------------------|----------|--------------------------------|------------------------|--------|-----------|-----|
| Clause | Requirement + Test | Result - Remark | Verdict | | | | | | | | | | | | | | | | | |
| 3.2.5.1 | <p>Modify Table 3B as follows:</p> <p>1. Delete the first four rows and replace with the following:</p> <table border="1"> <thead> <tr> <th rowspan="2">RATED CURRENT of equipment A</th> <th colspan="2">Minimum conductor sizes</th> </tr> <tr> <th>Nominal cross-sectional area mm²</th> <th>AWG or kcmil [cross-sectional area in mm²] see Note 2</th> </tr> </thead> <tbody> <tr> <td>Over 0.2 up to and including 3</td> <td>0,5 ^a</td> <td>18 [0,8]</td> </tr> <tr> <td>Over 3 up to and including 7.5</td> <td>0,75</td> <td>16 [1,3]</td> </tr> <tr> <td>Over 7.5 up to and including 10</td> <td>(0,75) ^b 1,00</td> <td>16 [1,3]</td> </tr> <tr> <td>Over 10 up to and including 16</td> <td>(1,0) ^c 1,5</td> <td>14 [2]</td> </tr> </tbody> </table> <p>2. Delete NOTE 1.</p> <p>3. Delete Footnote ^a and replace with the following: ^a This nominal cross-sectional area is only allowed for Class II appliances if the length of the power supply cord, measured between the point where the cord, or cord guard, enters the appliance, and the entry to the plug does not exceed 2 m (0,5 mm² three-core supply flexible cords are not permitted; see AS/NZS 3191).</p> | RATED CURRENT of equipment A | Minimum conductor sizes | | Nominal cross-sectional area mm ² | AWG or kcmil [cross-sectional area in mm ²] see Note 2 | Over 0.2 up to and including 3 | 0,5 ^a | 18 [0,8] | Over 3 up to and including 7.5 | 0,75 | 16 [1,3] | Over 7.5 up to and including 10 | (0,75) ^b 1,00 | 16 [1,3] | Over 10 up to and including 16 | (1,0) ^c 1,5 | 14 [2] | Replaced. | N/A |
| RATED CURRENT of equipment A | Minimum conductor sizes | | | | | | | | | | | | | | | | | | | |
| | Nominal cross-sectional area mm ² | AWG or kcmil [cross-sectional area in mm ²] see Note 2 | | | | | | | | | | | | | | | | | | |
| Over 0.2 up to and including 3 | 0,5 ^a | 18 [0,8] | | | | | | | | | | | | | | | | | | |
| Over 3 up to and including 7.5 | 0,75 | 16 [1,3] | | | | | | | | | | | | | | | | | | |
| Over 7.5 up to and including 10 | (0,75) ^b 1,00 | 16 [1,3] | | | | | | | | | | | | | | | | | | |
| Over 10 up to and including 16 | (1,0) ^c 1,5 | 14 [2] | | | | | | | | | | | | | | | | | | |
| 4.1.201 | <p>Insert a new Clause 4.1.201 after Clause 4.1 as follows:</p> <p>4.1.201 Display devices used for television purposes</p> <p>Display devices which may be used for television purposes, with a mass of 7 kg or more, shall comply with the requirements for stability and mechanical hazards, including the additional stability requirements for television receivers, specified in AS/NZS 60065.</p> | No such device. | N/A | | | | | | | | | | | | | | | | | |
| 4.3.6 | <p>Delete the third paragraph and replace with the following:</p> <p><i>Equipment with a plug portion, suitable for insertion into a 10 A 3-pin flatpin socket-outlet complying with AS/NZS 3112 shall comply with the requirements in AS/NZS 3112 for equipment with integral pins for insertion into socket-outlets.</i></p> | | N/A | | | | | | | | | | | | | | | | | |
| 4.3.16.5 | <p>Add the following to the end of the first paragraph:</p> <p>'or AS/NZS 2211.1'</p> | Added. | N/A | | | | | | | | | | | | | | | | | |

| IEC60950_1C - ATTACHMENT | | | |
|--------------------------|---|--|---------|
| Clause | Requirement + Test | Result - Remark | Verdict |
| 4.7 | Add the following new paragraph to the end of the clause: 'For alternate tests refer to Clause 4.7.201.' | Added. | N/A |
| 4.7.201 | Insert a new Clause 4.7.201 after Clause 4.7.3.6 as follows: 4.7.201 Resistance to fire – Alternative tests | Added. Alternative tests not applied for | N/A |
| 4.7.201.1 | <p>4.7.201.1 General</p> <p>Parts of non-metallic material shall be resistant to ignition and spread of fire.</p> <p>This requirement does not apply to decorative trims, knobs and other parts unlikely to be ignited or to propagate flames from inside the apparatus, or the following:</p> <p>(a) Components that are contained in an enclosure having a flammability category of V-0 according to AS/NZS 60695.11.10 and having openings only for the connecting wires filling the openings completely, and for ventilation not exceeding 1mm in width regardless of length.</p> <p>(b) The following parts which would contribute negligible fuel to a fire:</p> <ul style="list-style-type: none"> - small mechanical parts, the mass of which does not exceed 4g, such as mounting parts, gears, cams, belts and bearings; - small electrical components, such as capacitors with a volume not exceeding 1,750 mm³, integrated circuits, transistors and optocoupler packages, if these components are mounted on material of flammability category V-1, or better, according to AS/NZS 60695.11.10. <p>NOTE In considering how to minimize propagation of fire and what 'small parts' are, account should be taken of the cumulative effect of small parts adjacent to each other for the possible effect of propagating the fire from one part to another.</p> <p>Compliance shall be checked by the tests of 4.7.201.2, 4.7.201.3, 4.7.201.4 and 4.7.201.5.</p> <p>For the base material of printed boards, compliance shall be checked by the test of 4.7.201.5.</p> <p>The tests shall be carried out on parts of non-metallic material which have been removed from the apparatus. When the glow-wire test is carried out, the parts shall be placed in the same orientation as they would be in normal use.</p> <p>These tests are not carried out on internal wiring.</p> | | N/A |

| IEC60950_1C - ATTACHMENT | | | | | | | | | |
|--------------------------------|---|-----------------------------|---------|------------------|--|--------------------------------|---|--|-----|
| Clause | Requirement + Test | Result - Remark | Verdict | | | | | | |
| 4.7.201.2 | <p>4.7.201.2 Testing of non-metallic materials</p> <p>Parts of non-metallic material shall be subject to the glow-wire test of AS/NZS 60695.2.11 which shall be carried out at 550 °C.</p> <p>Parts for which the glow-wire test cannot be carried out, such as those made of soft or foamy material, shall meet the requirements specified in ISO 9772 for category FH-3 material. The glow-wire test shall be not carried out on parts of material classified at least FH-3 according to ISO 9772 provided that the sample tested was not thicker than the relevant part.</p> | | N/A | | | | | | |
| 4.7.201.3 | <p>4.7.201.3 Testing of insulating materials</p> <p>Parts of insulating material supporting POTENTIAL IGNITION SOURCES shall be subject to the glow-wire test of AS/NZS 60695.2.11 which shall be carried out at 750 °C.</p> <p>The test shall be also carried out on other parts of insulating material which are within a distance of 3 mm of the connection.</p> <p>NOTE Contacts in components such as switch contacts are considered to be connections.</p> <p>For parts which withstand the glow-wire test but produce a flame, other parts above the connection within the envelope of a vertical cylinder having a diameter of 20 mm and a height of 50 mm shall be subjected to the needle-flame test. However, parts shielded by a barrier which meets the needle-flame test shall not be tested.</p> <p>The needle-flame test shall be made in accordance with AS/NZS 60695.11.5 with the following modifications:</p> <table border="1"> <thead> <tr> <th>Clause of AS/NZS 60695.11.5</th> <th>Change</th> </tr> </thead> <tbody> <tr> <td colspan="2">9 Test procedure</td> </tr> <tr> <td>9.2 Application of needleflame</td> <td> <p>Replace the first paragraph with:</p> <p>The specimen shall be arranged so that the flame can be applied to a vertical or horizontal edge as shown in the examples of figure 1. If possible the flame shall be applied at least 10 mm from a corner</p> <p>Replace the second paragraph with:</p> <p>The duration of application of the test flame shall be 30 s</p> </td> </tr> </tbody> </table> | Clause of AS/NZS 60695.11.5 | Change | 9 Test procedure | | 9.2 Application of needleflame | <p>Replace the first paragraph with:</p> <p>The specimen shall be arranged so that the flame can be applied to a vertical or horizontal edge as shown in the examples of figure 1. If possible the flame shall be applied at least 10 mm from a corner</p> <p>Replace the second paragraph with:</p> <p>The duration of application of the test flame shall be 30 s</p> | | N/A |
| Clause of AS/NZS 60695.11.5 | Change | | | | | | | | |
| 9 Test procedure | | | | | | | | | |
| 9.2 Application of needleflame | <p>Replace the first paragraph with:</p> <p>The specimen shall be arranged so that the flame can be applied to a vertical or horizontal edge as shown in the examples of figure 1. If possible the flame shall be applied at least 10 mm from a corner</p> <p>Replace the second paragraph with:</p> <p>The duration of application of the test flame shall be 30 s</p> | | | | | | | | |

| IEC60950_1C - ATTACHMENT | | | | | | | | | |
|-------------------------------|--|-----------------|---------|------------------------------|--|-------------------------------|--|--|--|
| Clause | Requirement + Test | Result - Remark | Verdict | | | | | | |
| | <table border="1"> <tr> <td></td> <td>±1 s.</td> </tr> <tr> <td>9.3 Number of test specimens</td> <td>Replace with: The test shall be made on one specimen. If the specimen does not withstand the test, the test may be repeated on two further specimens, both of which shall withstand the test.</td> </tr> <tr> <td>11 Evaluation of test results</td> <td>Replace with: The duration of burning (t_b) shall not exceed 30 s. However, for printed circuit boards, it shall not exceed 15 s.</td> </tr> </table> <p>The needle-flame test shall not be carried out on parts of material classified as V-0 or V-1 according to AS/NZS 60695.11.10, provided that the sample tested was not thicker than the relevant part.</p> | | ±1 s. | 9.3 Number of test specimens | Replace with: The test shall be made on one specimen. If the specimen does not withstand the test, the test may be repeated on two further specimens, both of which shall withstand the test. | 11 Evaluation of test results | Replace with: The duration of burning (t_b) shall not exceed 30 s. However, for printed circuit boards, it shall not exceed 15 s. | | |
| | ±1 s. | | | | | | | | |
| 9.3 Number of test specimens | Replace with: The test shall be made on one specimen. If the specimen does not withstand the test, the test may be repeated on two further specimens, both of which shall withstand the test. | | | | | | | | |
| 11 Evaluation of test results | Replace with: The duration of burning (t_b) shall not exceed 30 s. However, for printed circuit boards, it shall not exceed 15 s. | | | | | | | | |
| 4.7.201.4 | <p>4.7.201.4 Testing in the event of non-extinguishing material</p> <p>If parts, other than enclosures, do not withstand the glow wire tests of 4.7.201.3, by failure to extinguish within 30 s after the removal of the glowwire tip, the needle-flame test detailed in 4.7.201.3 shall be made on all parts of non-metallic material which are within a distance of 50 mm or which are likely to be impinged upon by flame during the tests of 4.7.201.3. Parts shielded by a separate barrier which meets the needle-flame test need not be tested.</p> <p>NOTE 1 If the enclosure does not withstand the glow-wire test the equipment is considered to have failed to meet the requirements of Clause 4.7.201 without the need for consequential testing.</p> <p>NOTE 2 If other parts do not withstand the glow-wire test due to ignition of the tissue paper and if this indicates that burning or glowing particles can fall onto an external surface underneath the equipment, the equipment is considered to have failed to meet the requirements of Clause 4.7.201 without the need for consequential testing.</p> <p>NOTE 3 Parts likely to be impinged upon by the flame are considered to be those within the envelope of a vertical cylinder having a radius of 10 mm and a height equal to the height of the flame, positioned above the point of the material supporting, in contact with, or in close proximity to, connections.</p> | | N/A | | | | | | |
| 4.7.201.5 | <p>4.7.201.5 Testing of printed boards</p> <p>The base material of printed boards shall be subjected to the needle-flame test of Clause 4.7.201.3. The flame shall be applied to the edge</p> | | N/A | | | | | | |

| IEC60950_1C - ATTACHMENT | | | |
|--------------------------|---|-----------------|------------|
| Clause | Requirement + Test | Result - Remark | Verdict |
| | <p>of the board where the heat sink effect is lowest when the board is positioned as in normal use. The flame shall not be applied to an edge, consisting of broken perforations, unless the edge is less than 3 mm from a POTENTIAL IGNITION SOURCE.</p> <p>The test is not carried out if the —</p> <ul style="list-style-type: none"> - Printed board does not carry any POTENTIAL IGNITION SOURCE; - Base material of printed boards, on which the available apparent power at a connection exceeds 15 VA operating at a voltage exceeding 50 V and equal or less than 400 V (peak) a.c. or d.c. under normal operating conditions, is of flammability category V-1 or better according to AS/NZS 60695.11.10, or the printed boards are protected by an enclosure meeting the flammability category V-0 according to AS/NZS 60695.11.10, or made of metal, having openings only for connecting wires which fill the openings completely; or - Base material of printed boards, on which the available apparatus power at a connection exceeds 15 VA operating at a voltage exceeding 400 V (peak) a.c. or d.c. under normal operating conditions, and base material of printed boards supporting spark gaps which provides protection against overvoltages, is of flammability category V-0 according to AS/NZS 60695.11.10 or the printed boards are contained in a metal enclosure, having openings only for connecting wires which fill the openings completely. <p>Compliance shall be determined using the smallest thickness of the material.</p> <p>NOTE Available apparent power is the maximum apparent power which can be drawn from the supplying circuit through a resistive load whose value is chosen to maximise the apparent power for more than 2 min when the circuit supplied is disconnected.</p> | | |
| 6.2.2 | <p>For Australia only, delete the first paragraph and Note, and replace with the following:</p> <p>In Australia only, compliance with 6.2.2 shall be checked by the tests of both 6.2.2.1 and 6.2.2.2.</p> | No TNV. | N/A |

| IEC60950_1C - ATTACHMENT | | | |
|--------------------------|---|---|------------|
| Clause | Requirement + Test | Result - Remark | Verdict |
| 6.2.2.1 | <p>For Australia only, delete the first paragraph including the Notes, and replace with the following:</p> <p><i>In Australia only, the electrical separation is subjected to 10 impulses of alternating polarity, using the impulse test generator reference 1 of Table N.1. The interval between successive impulses is 60 s and the initial voltage, U_c, is:</i></p> <p><i>(i) for 6.2.1 a): 7.0 kV for hand-held telephones and for headsets and 2.5 kV for other equipment; and</i></p> <p><i>(ii) for 6.2.1 b) and 6.2.1 c): 1.5 kV.</i></p> <p>NOTE 201 The 7 kV impulse simulates lightning surges on typical rural and semi-rural network lines.</p> <p>NOTE 202 The value of 2.5 kV for 6.2.1 a) was chosen to ensure the adequacy of the insulation concerned and does not necessarily simulate likely overvoltages.</p> | No TNV. | N/A |
| 6.2.2.2 | <p>For Australia only, delete the second paragraph including the Note, and replace with the following:</p> <p><i>In Australia only, the a.c. test voltage is:</i></p> <p><i>(i) for 6.2.1 a): 3 kV; and</i></p> <p><i>(ii) for 6.2.1 b) and 6.2.1 c): 1.5 kV.</i></p> <p>NOTE 201 Where there are capacitors across the insulation under test, it is recommended that d.c. test voltages are used.</p> <p>NOTE 202 The 3 kV and 1.5 kV values have been determined considering the low frequency induced voltages from the power supply distribution system.</p> | No TNV. | N/A |
| 7.3 | <p>Add the following before the first paragraph:</p> <p>Equipment providing functions that fall only within the scope of AS/NZS 60065 and that incorporate a PSTN interface, are not required to comply with this Clause where the only ports provided on the equipment, in addition to a coaxial cable connection and a PSTN interface, are audio or video ports and analogue or data ports not intended to be used for telecommunications purposes.</p> | Not connected to cable distribution system. | N/A |
| Annex P | <p>Normative references</p> <p>(List of relevant Australia/New Zealand Standards that have been inserted in place of some of the International Standards)</p> | Added. | P |

| IEC60950_1C - ATTACHMENT | | | |
|--|--|-----------------|------------|
| Clause | Requirement + Test | Result - Remark | Verdict |
| J 60950-1 (H22) : 2009 TEST REPORT (Deviations from IEC 60950-1:2001, first edition) Special National conditions, National deviation and other information according to MITI Ordinance No. 85. <u>Japanese unique deviations</u> in J60950-1(H22):2009(=JIS C 6950-1:2009) | | | |
| 1.1.A | Add this sub-clause See Annex P for normative references | Added. | P |
| 1.2 | Add the following terms. Equipment, Class 0I 1.2.4.3A | Added. | N/A |
| 1.2.4.1 | Add the following NOTE 2: NOTE 2 – Even in the case of CLASS 0I equipment, two-pins plug with a protective earthing lead wire (an adapter for converting a Class 0I equipment plug into a two-pin plug without earthing wire) and cord sets having a two-pin type plug with a lead wire for earthing are also regarded as Class 0I equipment if they are included in packaging as accessories or if users are recommended to use them. | Added. | N/A |
| 1.2.4.3A | Add this sub-clause: CLASS 0I EQUIPMENT: Equipment where protection against electric shock is achieved by: using BASIC INSULATION, and providing a means of connecting to the protective earthing conductor in the building wiring those conductive parts that are otherwise capable of assuming HAZARDOUS VOLTAGES if the BASIC INSULATION fails, and using a supply cord without earthing conductor and a plug without earthing wire although the equipment has externally an earth terminal or a lead wire for earthing. Equipment provided with a cord set having a two-pin type plug with a lead wire for earthing is also regarded as Class 0I. NOTE – Class 0I equipment may have a part constructed with Double Insulation or Reinforced Insulation as well as an operating part as SELV circuit. | Added. | N/A |

| IEC60950_1C - ATTACHMENT | | | |
|--------------------------|--|-----------------|------------|
| Clause | Requirement + Test | Result - Remark | Verdict |
| 1.3.2 | <p>Add the following NOTE 1 and 2:</p> <p>Note1: transportable equipments or similar equipments that are frequently transported for use should not be considered Class I or Class 0I equipments. However, this shall not apply to equipments that are intended for installation by service personnel or installation personnel.</p> <p>Note 2: in consideration of the state of electrical power distribution in Japan, it is best to avoid the use of Class I or Class 0I devices if it is evident that it will be difficult to connect earthing during installation of the equipment. However, this shall not apply to devices that are intended for installation by service personnel or installation personnel.</p> | Added. | N/A |
| 1.5.1 | <p>When safety issues apply, in the absence of matters required by these specifications or JIS stipulated required matters concerning safety of related components, or in the absence of JIS concerning the component, the component must comply with one of the related IEC safety requirements. However, if a component compliant with ministerial ordinance (1962 Trade and Commerce Ministerial Ordinance No. 85) providing technical standards for electrical products is being used in accordance with the rating indicated for that component, apply articles 1.5.4, 2.8.7 and 3.2.5; electrical power cord sets that fit with inlets for equipments regulated by the IEC 60320-1 Standards Sheet must match the dimensions indicated on the applicable IEC 60320-1 Connector Standards Sheet.</p> <p>Note 1: regarding the JIS or IEC standards related to a component as related shall be limited to cases where the component in question is clearly within the scope of application of those standards.</p> | | P |

| IEC60950_1C - ATTACHMENT | | | |
|--------------------------|--|-----------------|------------|
| Clause | Requirement + Test | Result - Remark | Verdict |
| 1.5.2 | <p>In the case of components that are certified as being in compliance with JIS harmonized with the related IEC, it must be confirmed that the component is being used correctly in accordance with the stipulated standards. In the absence of JIS harmonized with the related IEC,</p> <p>Note 1: When using an IEC 60320-1 C.14 device coupler with rated voltage less than 125 V and rated current in excess of 10A, refer to 1.7.5A.</p> <p>If JIS harmonized with the IEC related to the component does not exist concurrently with the IEC standards, or if the component is using circuitry that does not comply with its rating, the component must be tested in accordance with the conditions and within equipment. The number of samples required for testing shall normally be the same as the number required under similar standards.</p> | | P |
| 1.5.6 | Replace "IEC 60384-14:1993" to "JIS C 5101-14:1998 or IEC 60384-14:1993" of this Sub-Clause | Replaced. | N/A |
| 1.5.7.2 | Replace "IEC 60384-14:1993" to "JIS C 5101-14:1998 or IEC 60384-14:1993" of this Sub-Clause | Replaced. | N/A |
| 1.5.8 | Replace "IEC 60384-14:1993" to "JIS C 5101-14:1998 or IEC 60384-14:1993" of this Sub-Clause | Replaced. | N/A |
| 1.7.1 | Add local importer in this sub-clause manufacturer's name or local importer or trademark or identification mark; | Added. | N/A |
| 1.7.5 | Replace "IEC 60083" to "IEC/TR 60083:1997 or JIS C 8303:2007" of this Sub-Clause | Replaced. | N/A |
| 1.7.5.A | <p>Add this sub-clause</p> <p>1.7.5A Device Coupler</p> <p>When using an IEC 60320-1 C.14 device coupler (rated current 10A) with rated voltage less than 125 V and rated current in excess of 10A, be sure to write "Only use power supply cord sets that are provided with this device" or a similar statement in the user's manual.</p> | Added. | N/A |

| IEC60950_1C - ATTACHMENT | | | |
|--------------------------|---|-----------------|---------|
| Clause | Requirement + Test | Result - Remark | Verdict |
| 1.7.17A | <p>Add this sub-clause:</p> <p><i>Marking for CLASS 0I EQUIPMENT</i></p> <p>For CLASS 0I EQUIPMENT, the following instruction shall be indicated on the visible place of the mains plug or the main body: “Provide an earthing connection”</p> <p><i>Example in Japanese:</i> 必ず接地接続を行って下さい</p> <p>Moreover, for CLASS 0I EQUIPMENT, the following instruction shall be indicated on the visible place of the main body or written in the operating instructions: “Provide an earthing connection before the mains plug is connected to the mains. And, when disconnecting the earthing connection, be sure to disconnect after pulling out the mains plug from the mains.”</p> <p><i>Example in Japanese:</i> 接地接続は必ず、電源プラグを電源につなぐ前に行ってください。又、接地接続を外す場合は、必ず電源プラグを電源から切り離してから行って下さい。</p> | Added. | N/A |
| 2.1.1.1 | In the Item b) of this Sub-Clause, replace “IEC 60083” to “IEC 60083 or JIS C 8303:2007”. | Replaced. | N/A |
| 2.6.3.2 | <p>Add the following in front of 1st paragraph of this Sub-Clause.</p> <p>This also applies to the conductor of lead wire for protective earthing of CLASS 0I EQUIPMENT.</p> | Added. | N/A |
| 2.6.3.4 | <p>Add the following in this Sub-Clause.</p> <p>(See 2.6.3.3)</p> | Added. | N/A |
| 2.6.4.2 | <p>Add the following after 1st paragraph of this Sub-Clause.</p> <p>However, this shall not apply when the Class 0I equipment is equipped with a separate main protective earthing terminal.</p> | Added. | N/A |
| 2.6.5.4 | <p>Replace the first sentence of this Sub-Clause by:</p> <p>Protective earthing connections of CLASS I EQUIPMENT shall make earlier and break later than the supply connections in each of the following:</p> | Replaced. | N/A |

| IEC60950_1C - ATTACHMENT | | | |
|--------------------------|---|-----------------|---------|
| Clause | Requirement + Test | Result - Remark | Verdict |
| 2.6.5.8A | <p>Add this sub-clause:</p> <p><i>Earthing of CLASS 0I EQUIPMENT</i> Plugs with a lead wire for earthing shall not be used for equipment having a rated voltage exceeding 150V. For plugs with a lead wire for earthing, the lead wire shall not be earthed by a clip. CLASS 0I EQUIPMENT shall be provided with an earthing terminal or lead wire for earthing in the external where easily visible.</p> | Added. | N/A |
| 2.10.1 | Replace "IEC 60664-1" to "JIS C 0664:2003" in NOTE of this Sub-Clause | Replaced. | N/A |
| 2.10.3.1 | Replace "IEC 60664-1" to "JIS C 0664:2003" in NOTE 1 and NOTE 2 | Replaced. | N/A |
| 2.10.3.2 | Replace "IEC 60664-1" to "JIS C 0664:2003" in the first sentence of this Sub-Clause | Replaced. | N/A |
| 3.2.3 | <p>Add the following after Table 3A of this Sub-Clause.</p> <p>Table 3A shall apply when a JIS C 3662 or JIS C 3663 compliant cable is used. Other cables that are used must be designed to allow suitable conduits to be run in,</p> | Added. | N/A |
| 3.2.5.1 | <p>Add the following of this Sub-Clause.</p> <p>Or must be sheathed in accordance with Section 1, Annex 1 of the ministerial ordinance (1962 Trade and Commerce Ministerial Ordinance No. 85) providing technical standards for electrical products.</p> <p>- Or must be sheathed in accordance with Section 1, Annex 1 of the ministerial ordinance (1962 Trade and Commerce Ministerial Ordinance No. 85) providing technical standards for electrical products.</p> <p>- Electric cables that comply with JIS C 3662 or JIS C 3663 have a conductor with a cross-sectional area value greater than the values provided for in Table 3B. Other electrical cables comply with relevant wiring regulations.</p> <p>Delete 1) in Table 3B.</p> | Deleted. | N/A |
| 3.3.4 | <p>Add the following in Table 3D</p> <p>Note: when using JIS C 3662 or JIS C 3663-compliant electrical wiring, the terminal must enable connection of electric wiring commensurate with the regulated sizes</p> | Added. | N/A |

| IEC60950_1C - ATTACHMENT | | | |
|--------------------------|--|-----------------|------------|
| Clause | Requirement + Test | Result - Remark | Verdict |
| 3.3.7 | Add the following after 1 st paragraph of this Sub-Clause. ◦ However, this shall not apply to the external grounding terminals of Class 0I equipment. | Added. | N/A |
| 4.3.4 | Add the following of this Sub-Clause. ◦ Class 0I equipment where the values for creepage distance and clearance distance of the basic insulation drop further to a level lower than that stipulated in 2.10 must be properly fixed to withstand the mechanical stress generated in the course of normal use. | Added. | N/A |
| 4.3.5 | Replace "IEC 60083" to "JIS C 8303:2007" in the first sentence of this Sub-Clause | Replaced. | N/A |
| 4.3.13.3 | Add the following in Table 4A Note: JIS K 7161:1994, JIS K 7162:1994, IS K 7127:1999 are available as JIS compatible with part of ISO527. | Added. | N/A |
| 4.3.13.5 | Replace "IEC 60825-1" to "JIS C 6802:2005 or JIS C of this Sub-Clause | Replaced. | N/A |
| | Replace "IEC 60825-2:2000" to "JIS C 6803:2006 or IEC 60825-2:2000" of this Sub-Clause | Replaced. | N/A |
| 4.5.1 | Add the following to Suffix 3) of Table 4B (part one and part two). Note: When data concerning materials is unavailable, Annex 4, 1 (1) 3 of "Regarding Interpretation of Ministerial Ordinance Providing Technical Standards for Electrical Products" (June 19, 2008 Bureau of Commerce No. 3) may be applied to Item 1. | Added. | P |

Attachment

The insulating materials shall not be exposed to the temperature exceeding the values when the appliance is operated at rated voltage and normal operating condition.

These values may be increased by;

8 degrees for Duty 2 appliance, and

16 degrees for Duty 3 appliance.

In order to classify the appliances, following assumptions are to be used.

Duty 1 appliances: considered to be connected to supply mains throughout the years such as refrigerators

Duty 2 appliances: considered to be connected to be in between Duty 1 and Duty 3 such as room heaters

Duty 3 appliances: considered to be connected to supply mains when it is operated for rather short time such as portable coffee mill.

Permissible temperature limits of insulating materials

| Natural materials | |
|---|------------------------------------|
| Material | Permissible temperature limit (°C) |
| Bituminous compound for filter | 75, (105) 1) |
| Paper, cotton, silk, other natural fiber and wood | 90, (105) 2) |
| Oil denatured natural resin | 105 |

| IEC60950_1C - ATTACHMENT | | | |
|--------------------------|--------------------|-----------------|---------|
| Clause | Requirement + Test | Result - Remark | Verdict |

| | |
|---------------|---------------|
| Silica powder | 500 |
| Mica (Hard) | 500, (600) 3) |
| (Soft) | 650, (850) 3) |

Notes: 1) Value applies to thermal insulating materials.

2) Value applies to materials impregnated with varnish.

3) Value in parenthesis is applied when mechanical external force is absent.

Mica splittings and untreated mica papers

| Lining | Adhesive | | | | | | | Permissible Temperature Limit (°C) |
|---|----------|---|---|---|---|---|---|--|
| | a | b | c | d | e | f | g | |
| None | X | X | X | X | X | X | X | 130 155 180; 450, (700) ¹⁾ ; 600, (800) ²⁾ 600, (700) ¹⁾ ; 700, (850) ²⁾ |
| Paper | X | X | X | X | | | | 130 |
| Polyethylene terephthalate film | | | | X | | | | 130 |
| Glass fabric | | | | X | X | X | | 130 155 180 |
| Polyester nonwoven fabric, Polyester woven, and Polyethylene naphthalate film | | | | X | X | | | 130 155 |
| Polyamide-imide film, Aramide film, and Polymide film | | | | | | X | X | 155 180 |

a: with asphalt base

b: with natural resin or denatured natural resin base

c: with ceramic base

d: with oil-denatured synthetic resin, alkyd orthophthalate resin or cross-linked polyester base.

e: with silicon-denatured synthetic resin, isophthalate alkyd resin, telephthalate alkyd resin or epoxy resin.

f: with silicon resin.

g: inorganic

Notes: 1) value applies to hard mica-made heating substrate.

2) value applies to soft mica-made heating substrate.

Remarks: value in parenthesis is applied when mechanical external force is absent.

Organic materials (Thermosetting Resins)

| Material | Permissible temperature limit (°C) |
|---|------------------------------------|
| laminated melamine resin mixed with glass fiber | 75, (100) ¹⁾ |
| moulded melamine resin mixed with: | |
| cellulose | 120 |
| inorganics | 140 |
| laminated phenol resin with: | |
| cotton fiber base | 115, (85) ²⁾ |
| paper base | 120, (70) ³⁾ |

| IEC60950_1C - ATTACHMENT | | | |
|--------------------------|--|--------------------------|---------|
| Clause | Requirement + Test | Result - Remark | Verdict |
| | polyamide cloth base | 75 | |
| | inorganics | 140 | |
| | moulded phenol resin with: | | |
| | inorganics | 150, (160) ¹⁾ | |
| | others | 140, (150) ¹⁾ | |
| | moulded melamine phenol resin with the gravity of less than 1.55 | 130 | |
| | moulded urea resin mixed with cellulose | 90 | |
| | unsaturated polyester-casting | 120 | |
| | laminated unsaturated polyester mixed with inorganics | 140 | |
| | moulded unsaturated polyester mixed with: | | |
| | other than organics | 120 | |
| | inorganic powder | 140 | |
| | glass fiber | 155 | |
| | epoxy resin-casting | 120 | |
| | laminated epoxy resin mixed with: | | |
| | inorganic | 130, (140) ¹⁾ | |
| | other than inorganics | 110, (90) ³⁾ | |
| | moulded epoxy resin mixed with inorganics | 130 | |
| | laminated diallyl phthalate resin mixed with inorganics | 140 | |
| | moulded diallyl phthalate resin mixed with: | | |
| | other than inorganics | 130 | |
| | inorganic powder | 150 | |
| | glass fiber | 155 | |
| | xylene resin-casting | 140 | |
| | polyamide-imide film | 180 | |
| | laminated silicone resin mixed with inorganics | 180, (220) ¹⁾ | |
| | moulded silicon resins mixed with inorganics | 180, (240) ⁴⁾ | |
| | polyimide film | 210 | |
| | laminated polyimide | 190 | |
| | polybutadiene-casting | 120 | |
| | moulded polybutadiene mixed with inorganics | 130 | |
| | laminated dipheny oxide mixed with inorganics | 180 | |

Notes: 1) Values apply to thermal insulating materials.

2) Values apply to materials with a thickness less than 0.8 mm.

3) Values apply to materials with a thickness less than 0.8 mm when treated to retard flame.

4) Values apply to materials used for thermal insulation and to seal outlets of sheathed heating wires.

Organic materials (Thermoplastic Resins)

| Material | Permissible temperature limit (°C) |
|--|------------------------------------|
| methacrylic resin, cellulose resin, cellulose acetate butylate resin, ulcanise, polyethylene | 50 |
| foamed polyethylene compound for insulated conductors, polyvinyl chloride | 60 |
| polyethylene compound for insulated conductors, heat-resistant polyvinyl chloride, cross-linked polyvinyl chloride compound for insulated conductors | 75 |
| cross-linked polyethylene, chlorinated polyethylene compound for insulated conductors | 90 |
| acrylonitrile acrylic rubber styrene resin, acrylonitrile chlorinate polyethylene styrene | 55 |

IEC60950_1C - ATTACHMENT

| Clause | Requirement + Test | Result - Remark | Verdict |
|--------|---|--------------------------------|---------|
| | resin | | |
| | acrylonitrile styrene resin, acrylonitrile butadiene resin, acrylonitrile butadiene chlorinated polyethylene resin : general : reinforced with glass fiber | 55 80 | |
| | polypropylene : general : reinforced with glass fiber | 105, (85) ³⁾ 110 | |
| | denatured polyphenylene oxide : general : reinforced with glass fiber | 75 100 | |
| | Polystyrene | 50, (70) ¹⁾ | |
| | polyacetal : general : reinforced with glass fiber | 100 120 | |
| | polyamide : general : reinforced with glass fiber | 90 120 | |
| | polycarbonate : general : reinforced with glass fiber | 110 120 | |
| | polyethylene terephthalate : general : reinforced with glass fiber | 120 130 | |
| | polybutylene terephthalate : general : reinforced with glass fiber | 120 135 | |
| | heat resistant polyethylene terephthalate film | 135 | |
| | fluorinated polyvinylidene compound for insulated conductors, polychlorotrifluoroethylene (ethylene-trifluoride resin), ethylene-tetrafluoroethylene copolymer for insulated conductors | 150 | |
| | tetrafluoroethylene hexafluoropropylene resin | 200 | |
| | polytetrafluoroethylene(ethylene-tetrafluoride), perfluoroalkoxy compound for insulated conductors | 250 | |
| | aramide(aromatic polyamide paper) | 220 | |
| | Polysulfone | 140, (150) ²⁾ | |
| | polyethylene naphthalate | 155 | |
| | polyallylate : general : reinforced with glass fiber | 120 130 | |

Notes : 1) Values apply to capacitor dielectrics.

2) Values apply to thermal insulating material

3) Values apply to materials with a thickness of less than 0.8 mm

4) Inorganic materials

Inorganic materials

| Material | Permission temperature limit (°C) |
|----------------------------------|-----------------------------------|
| glass fiber (only alkaline free) | 300 |
| lead glass | 380 |
| borosilicate glass | 490 |
| quartz glass | 800 |
| ceramic | 800, (1000) ¹⁾ |

Note: 1) Value apply to materials used as electric heating elements

Rubber compounds

| IEC60950_1C - ATTACHMENT | | | |
|--------------------------|--------------------|-----------------|---------|
| Clause | Requirement + Test | Result - Remark | Verdict |

| Material | Permission temperature limit (°C) |
|---|-----------------------------------|
| natural rubber, polyurethane rubber, ebonite | 60 |
| nitrile rubber, styrene butadiene rubber, chloroprene rubber | 75 |
| butyl rubber | 80 |
| ethylene propylene (diene) rubber, chlorosulfonated polyethylene rubber | 90 |
| silicone rubber | 180, (200) ¹⁾ |

Note : 1) Value apply to thermal insulating material and sealing compounds for sheathed heating elements.

Sleeves, Cloth, Tapes and like

| Material | Impergnat or coating | Permission temperature limit (°C) |
|---|---|-----------------------------------|
| rayon, cellulose acetate, vinylon | adhesive, oil varnish | 105 |
| paper, cotton fabric, silk fabric, polyamide, polyester fabric, polyester nonwoven fabric | oil varnish | 105 |
| polyester fabric, polyester nonwoven fabric | alkyd resin varnish | 120 |
| glass fabric | (ditto) | 130 |
| paper | Iso or terephthalate alkyd resin varnish, epoxy resin varnish, alkyd resin varnish | 105 |
| polyester fabric, polyester nonwoven fabric | (ditto) | 120 |
| glass fabric, aramide paper | Iso or terephthalate, alkyd resin varnish, epoxy resin varnish, silicone resin varnish, silicone rubber | 155 180 |
| vulcanised fiber | | 105 |
| heat resistant fiber | | 120 |

| | | | |
|----------------------------|---|---|---|
| 5.1.3 | Add the following NOTE Note: Note that domestic three-phase power distribution systems have many delta connections, in which case tests should be performed using IEC 60990:1990 Figure 13 test circuitry. | Added. | N/A |
| 5.1.6 Table 5A | Replace Table 5A of this Sub-Clause by: | Replaced. | N/A |
| Table 5A – Maximum current | | | |
| | Type of equipment | Terminal A of measuring instrument connected to: | Maximum TOUCH CURRENT mA r.m.s. ¹⁾ |
| | ALL equipment | Accessible parts and circuits not connected to protective earth | - |
| | HAND-HELD | | - |
| | | | Maximum PROTECTIVE CONDUCTOR CURRENT |

| IEC60950_1C - ATTACHMENT | | | | |
|--------------------------|--|--|---------|----------------------|
| Clause | Requirement + Test | Result - Remark | Verdict | |
| | MOVABLE (other than HAND-HELD, but including TRANSPORTABLE EQUIPMENT | Equipment main protective earthing terminal (if any) CLASS I EQUIPMENT | 3,5 | - |
| | STATIONARY, PLUGGABLE TYPE A | | 3,5 | - |
| | ALL other STATIONARY EQUIPMENT not subject to the conditions of 5.1.7 | | 3,5 | - |
| | - subject to the conditions of 5.1.7 | | - | 5 % of input current |
| | HAND-HELD | | 0,5 | - |
| | Others | (if any) CLASS 0I EQUIPMENT | 1,0 | - |
| | ¹⁾ If peak values of TOUCH-CURRENT are measured, the maximum values obtained by multiplying the r.m.s. values by 1,414. | | | |
| 6 | Add the following after NOTE1 of this Sub-Clause. Refer to the accompanying document, JB, for details concerning appropriate additional measures, | Added. | | N/A |
| | Replace "IEC 60664-1" to "JIS C 0664 in note 4 | Replaced. | | N/A |
| 7 | Replace "IEC 60664-1" to "JIS C 0664:2003 of this NOTE 3 | Replaced. | | N/A |
| 7.2 | Add the following However, when all of the following criteria are satisfied, the separation requirement and test in 6.2.1 a), b) and c) shall not be applied to the cable distribution system. <ul style="list-style-type: none"> - the applicable circuit is a TNV-1 circuit. - the applicable circuit's common side or grounding side is connected to the coaxial cable shielding, and to all accessible parts and circuits (SELV circuits, accessible metal parts, and limited current circuits also applicable if they exist) - the external conductor of the coaxial cable is intended to be connected to the grounding wire used for building wiring. | Added. | | N/A |
| Annex G 2.1 | Replace "IEC 60664-1" to "JIS C 0664:2003" | Replaced. | | N/A |
| Annex G 6 | Replace "IEC 60664-1" to "JIS C 0664:2003" | Replaced. | | N/A |
| Annex N | Add Note Note: ITU-T Recommendation K.17:1996 has been abolished and replaced with ITU-T Recommendation K.44:2003, K.45:2003. | Added. | | N/A |

| IEC60950_1C - ATTACHMENT | | | |
|--------------------------|--|-----------------|------------|
| Clause | Requirement + Test | Result - Remark | Verdict |
| | Note: The ITU-T Recommendation K.21:1996 test circuit was replaced with K.44:2003 in July 2003. | | N/A |
| Annex P | Add the following terms. <u>JIS C 5101-14:1998 Fixed capacitors for use in electronic equipment -- Part 14: Type-specific standards: Fixed capacitors for electromagnetic interference suppression in electrical power supply</u> Fixed capacitors for use in electronic equipment –Part 14: Sectional specification: Fixed capacitors for electromagnetic interference suppression and connection to the supply mains | Added. | N/A |
| | Replace “IEC 60065:1998” to “IEC 60065:2001” | Replaced. | N/A |
| | Add the following terms. JIS C 6802:2005 | Added. | N/A |
| | Add the following terms. JIS C 6803:2006 2004. | Added. | N/A |
| | Add the following terms. JIS C 8303:2007 | Added. | N/A |
| | Add the following terms. JIS S 0101:2000 | Added. | N/A |
| | Add the following terms. ITU-T Recommendation K.44:2003 , Resistibility tests for telecommunication equipment exposed to overvoltages and overcurrents – Basic Recommendation. | Added. | N/A |
| | Add the following terms. ITU-T Recommendation K.45:2003 , Resistibility of telecommunication equipment installed in the access and trunk networks to overvoltages and overcurrents. | Added. | N/A |
| Annex Q | Add the following terms. ITU-T Recommendation K.66:2004 , Protection of customer premises from overvoltages. | Added. | N/A |
| Annex T | Replace “IEC 60529:1989” to “JIS C 0920:2003 | Replaced. | N/A |
| Annex W.1 | Add following. Equipment, Class 0I | Added. | N/A |

| IEC60950_1C - ATTACHMENT | | | |
|--------------------------|---|--|---------|
| Clause | Requirement + Test | Result - Remark | Verdict |
| Annex JA | Add Annex JA (Document shredding machines) Document shredding machines shall also comply with the requirements of this annex except those of STATIONARY EQUIPMENT used by connecting directly to an AC MAINS SUPPLY of three-phase 200V or more. | Added. Not Document shredding machines. | N/A |
| JA.1 | <p>Markings and instructions <i>In the easily visible part near the document-slot, by a method capable to make out clearly and not easily disappeared, and by easily understandable wording, shall indicate the symbol of;</i></p> <p></p> <p>and, also the following precautions for use; that use by an infant/child may cause a hazard of injury etc.;</p> <p>that a hand can be drawn into the mechanical section for shredding when touching the document-slot;</p> <p>that clothes can be drawn into the mechanical section for shredding when touching the document-slot;</p> <p>that hairs can be drawn into the mechanical section for shredding when touching the document-slot;</p> <p>in case of equipment incorporating a commutator motor, that equipment may catch fire or explode by spraying of flammable gas.</p> | Added. Not Document shredding machines. | N/A |
| JA.2 | <p>Inadvertent reactivation</p> <p>Any safety interlock which can be operated by means of the test finger, Figure JA.1, is considered to cause reactivation of the hazard. Compliance is checked by inspection and, where necessary, by a test with the test finger, Figure JA.1.</p> | Added. Not Document shredding machines. | N/A |

| IEC60950_1C - ATTACHMENT | | | |
|--------------------------|--------------------|-----------------|---------|
| Clause | Requirement + Test | Result - Remark | Verdict |

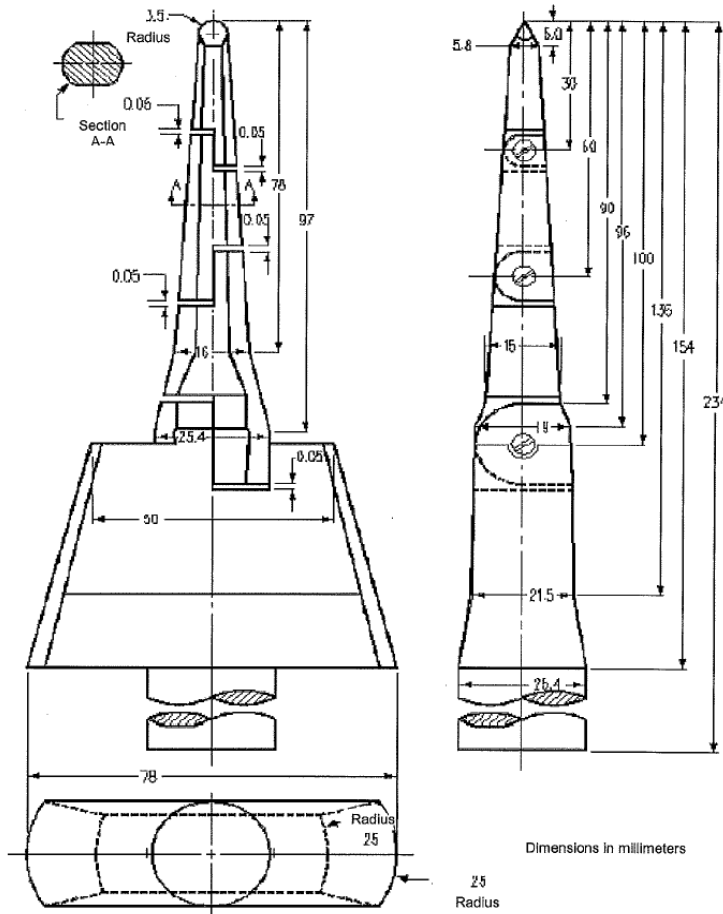
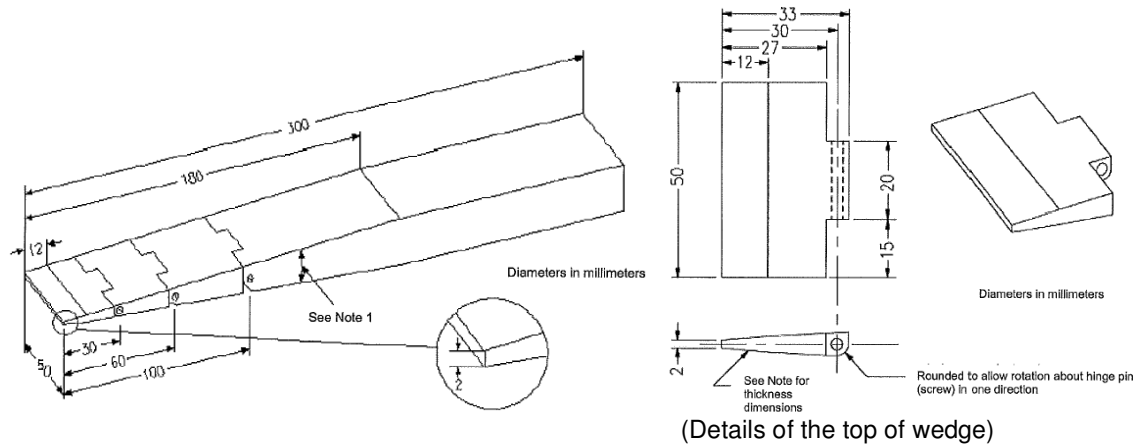

Figure JA.1 Test finger

| IEC60950_1C - ATTACHMENT | | | |
|--------------------------|---|--|---------|
| Clause | Requirement + Test | Result - Remark | Verdict |
| JA.3 | <p style="text-align: center;">Isolating switch</p> <p>Document shredding machines shall incorporate an isolating switch complying with sub-clause 3.4.2 as the device disconnecting the power of hazardous moving parts. For this switch, two-position (single-use) switch or multi-position (multifunction) switch (e.g., slide switch) may be used.</p> <p>If two-position switch, the positions for "ON" and "OFF" shall be indicated in accordance with sub-clause 1.7.8. If multi-position switch, the position for "OFF" shall be indicated in accordance with sub-clause 1.7.8 and other positions shall be indicated with proper terms or symbols.</p> <p>Compliance is checked by inspection.</p> | Added. Not Document shredding machines. | N/A |
| JA.4 | <p style="text-align: center;">Protection in operator access areas</p> <p>Any warning shall not be used instead of the structure for preventing access to hazardous moving parts.</p> <p>Document shredding machines shall comply with the following requirements.</p> <p>Push the test finger, Figure JA.1, into all openings in MECHANICAL ENCLOSURES without applying additional force. It shall not be possible to touch hazardous moving parts with the test finger. The document shredding machine is installed as intended, and all face of MECHANICAL ENCLOSURES are subjected to this test. Before testing with the test finger, remove the parts detachable without a tool.</p> <p>Push the wedge-probe, Figure JA.2, into the document-slot. And, against all directions of openings, if straight-cutting type, a force of 45 N shall apply to the probe, and 90 N if cross-cutting type. In this case, the weight of the probe shall not influence the test. Before testing with the test finger, remove the parts detachable without a tool. It shall not be possible to touch any hazardous moving parts, including the shredding roller or the mechanical section for shedding, with the probe.</p> | Added. Not Document shredding machines. | N/A |

| IEC60950_1C - ATTACHMENT | | | |
|--------------------------|--------------------|-----------------|---------|
| Clause | Requirement + Test | Result - Remark | Verdict |



| Distance from the top | Thickness of probe |
|-----------------------|--------------------|
| 0 | 2 |
| 12 | 4 |
| 180 | 24 |

Note 1 - The probe shall be of changing the thickness linearly. However, the slope shall

be changed at the respective points shown in the table.

Note 2 -The allowable dimensional tolerance of the probe is +/- 0.127 mm.

Figure JA.2 Wedge-probe

| | | | |
|-----------------------|--|--------|-----|
| Annex JB (reference) | Add Annex JB (Current state and means of handling overvoltage and overcurrent in the installation environment) The objective of this reference is not to propose new technical standards for the device. As a means of reducing the possibility that voltages in excess of 1.5kV peak may be applied to the device, these specifications provide for matters that must be adhered to concerning the device on the premise that it is installed in an environment within which appropriate measures have been taken in accordance with "ITU-T Recommendation K.11:1993 ". However, since environments that are not commensurate with this K.11 are often discovered domestically, this document attempts to describe the preferred environment and demonstrate the means for developing the preferred installation environment, thus contributing to its enhancement. | Added. | N/A |
| JB.1 | JB.1 Preferred installation environment | | N/A |
| JB.2 | Current state and means of handling overvoltage and overcurrent in the installation environment | | N/A |

| IEC60950_1C - ATTACHMENT | | | |
|--------------------------|---|---|------------|
| Clause | Requirement + Test | Result - Remark | Verdict |
| Appendix | J3000 (H21) Special National conditions, National deviation and other information according to MITI Ordinance No. 85. | | — |
| 1 | General requirement When equipment provides with appliance inlet complying with JIS-C 8283-1(2008), soldered parts of appliance inlet is not applied by force during insert or removal of connector. This is not applied when inlet body is fixed itself and not fixed by solder. | Class III product. No such appliance inlet. | N/A |
| 2 | Requirement for equipment | | — |
| 2.1 | Electric heater When diode is used in parallel for adjustment of power, the equipment shall remain safe for operation under open condition of one diode. | Not electric stove. | N/A |
| | The current rating of one diode shall be more than main current. The diodes connected in parallel are same type. | | N/A |
| | The heating test specified by clause 11 of JIS C 9335-2-30(2006) under open condition of one diode shall comply with the requirements. | | N/A |
| 2.2 | Electric heater with glowing heating elements | Not electric stove. | N/A |
| | Surface treatment by paint or adhesive on protective frame or protective mesh shall not be used. | | N/A |
| | Caution marking like below shall be on - easily visible place of the equipment or - Instruction manual 「注意 当該機器から、使用初期段階で揮発性有機化合物およびカルボニル化合物が最も放散するおそれがあるため、その際には十分換気を行うこと。」 | | N/A |
| 3 | Components used in equipment | No relevant equipment or component. | N/A |
| 3.1 | Motor capacitors used in air conditioner, electric washing machine, refrigerator or electric freezer shall be comply with - capacitors with protective elements or protective mechanism complying with JIS C 4908(2007) - P2 capacitor complying with IEC 60252-1(2001) Capacitor complying with below is acceptable | | N/A |
| | Enclosed by metal or ceramic | | N/A |
| | No non-metallic materials within 50 mm from capacitor surface | | N/A |
| | Non-metallic material within 50 mm from capacitor surface comply with needle frame test | | N/A |

| IEC60950_1C - ATTACHMENT | | | |
|--------------------------|--|-----------------|------------|
| Clause | Requirement + Test | Result - Remark | Verdict |
| | of JIS C 9335-1(2003), Annex E | | |
| | Non-metallic material within 50 mm from capacitor surface comply with V-1 test of JIS C 60965-11-10(2006). | | N/A |
| 3.2 | <p>Plug directly inserted to outlet used refrigerator or electric freezer.</p> <p>Shall comply with</p> <ul style="list-style-type: none"> - Face contact with outlet shall have CTI with more than 400 according to JIS C 2134(2007) or - Supporting material of blades shall comply with glow wire test by temperature of 750°C according to JIS C 60695-2-11(2004) or JIS C 60695-2-12(2004). <p>Materials having glow wire frame temperature of 775 °C are acceptable.</p> | | N/A |

Type Designation: See test report
Report Number: 17028398 001



Figure 1.



Figure 2.

Type Designation: See test report
Report Number: 17028398 001



Figure 3.



Figure 4.

Type Designation: See test report
Report Number: 17028398 001



Figure 5.

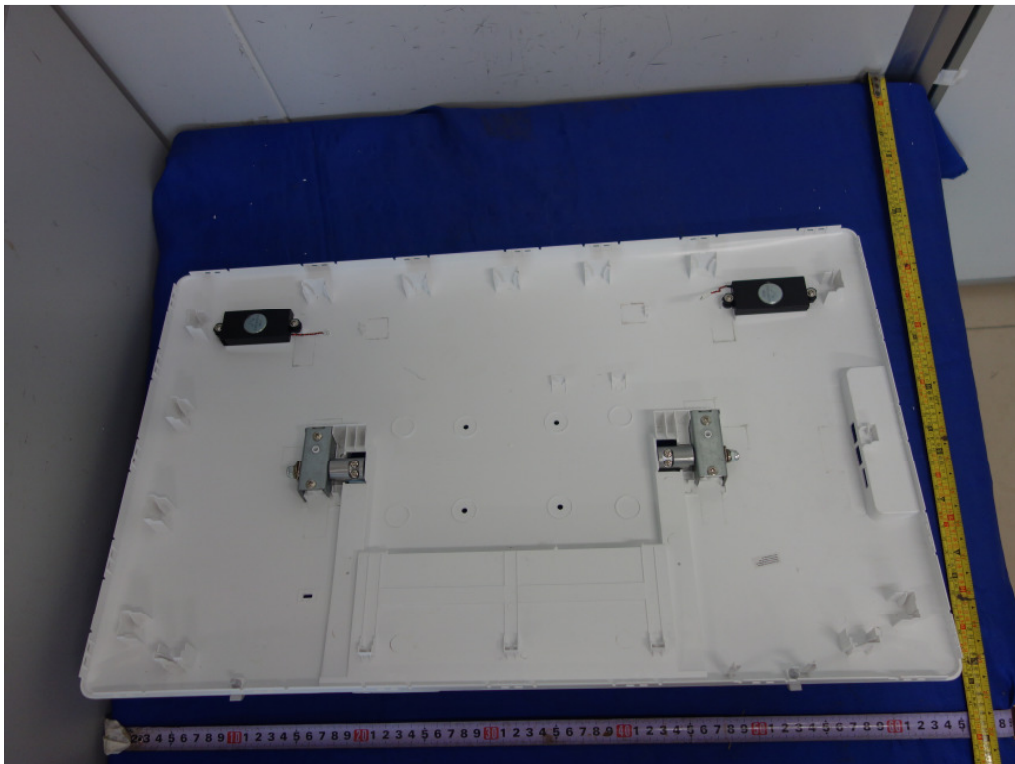

Figure 6.

Type Designation: See test report
Report Number: 17028398 001

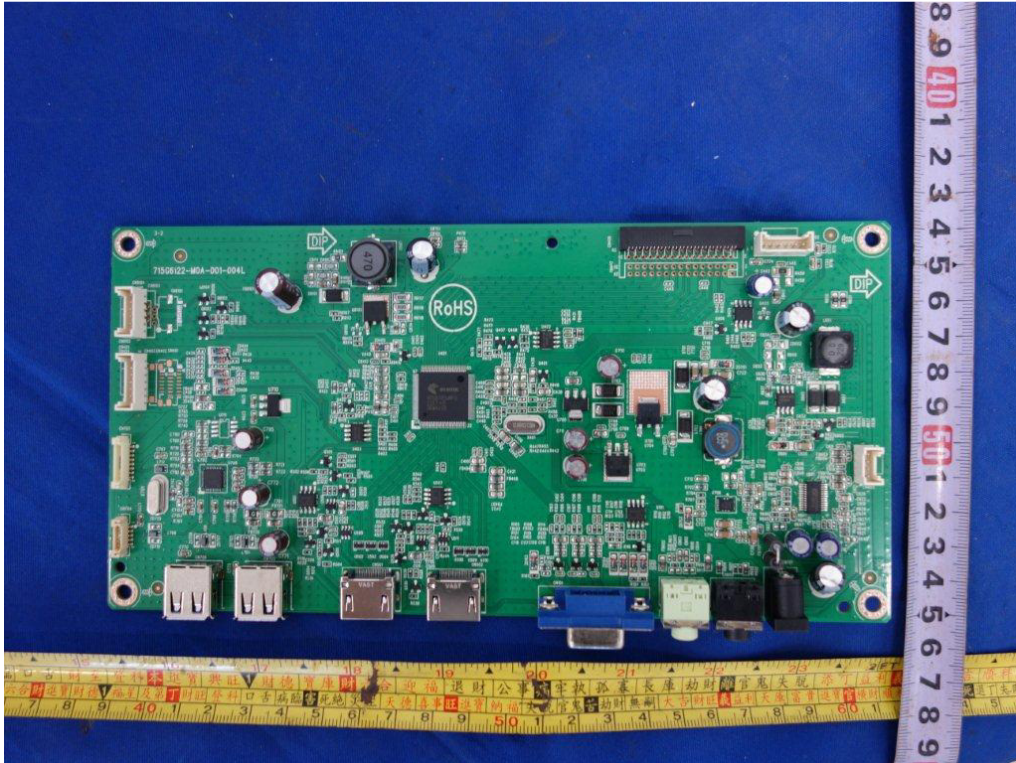

Figure 7.

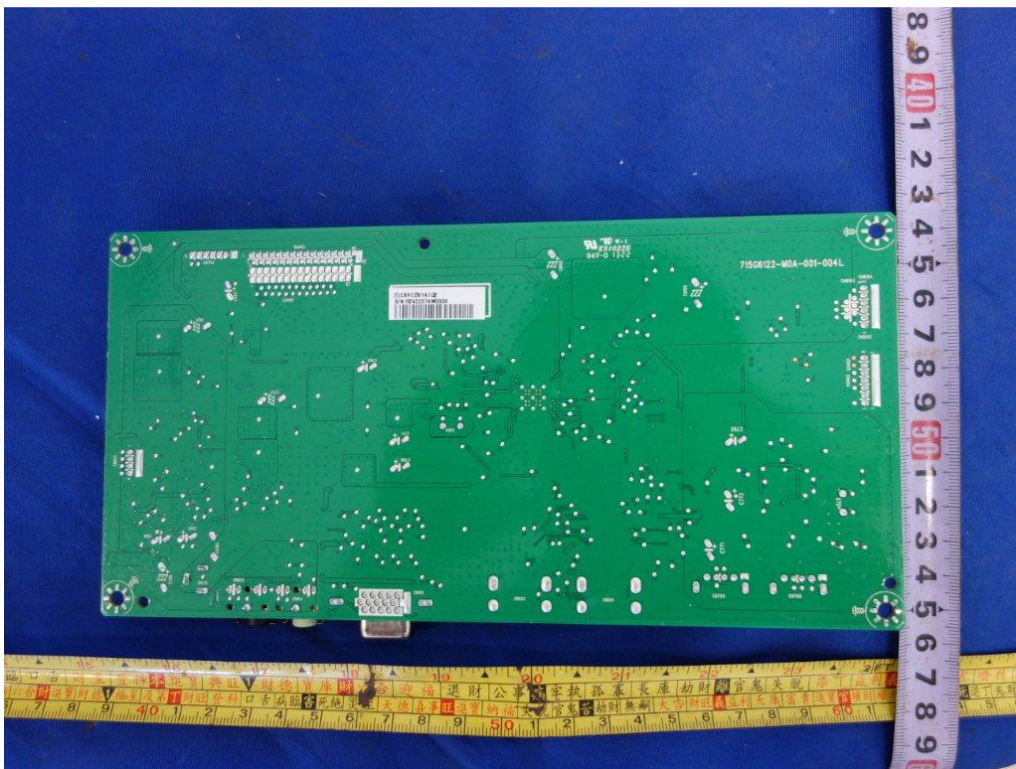

Figure 8.

Type Designation: See test report
Report Number: 17028398 001

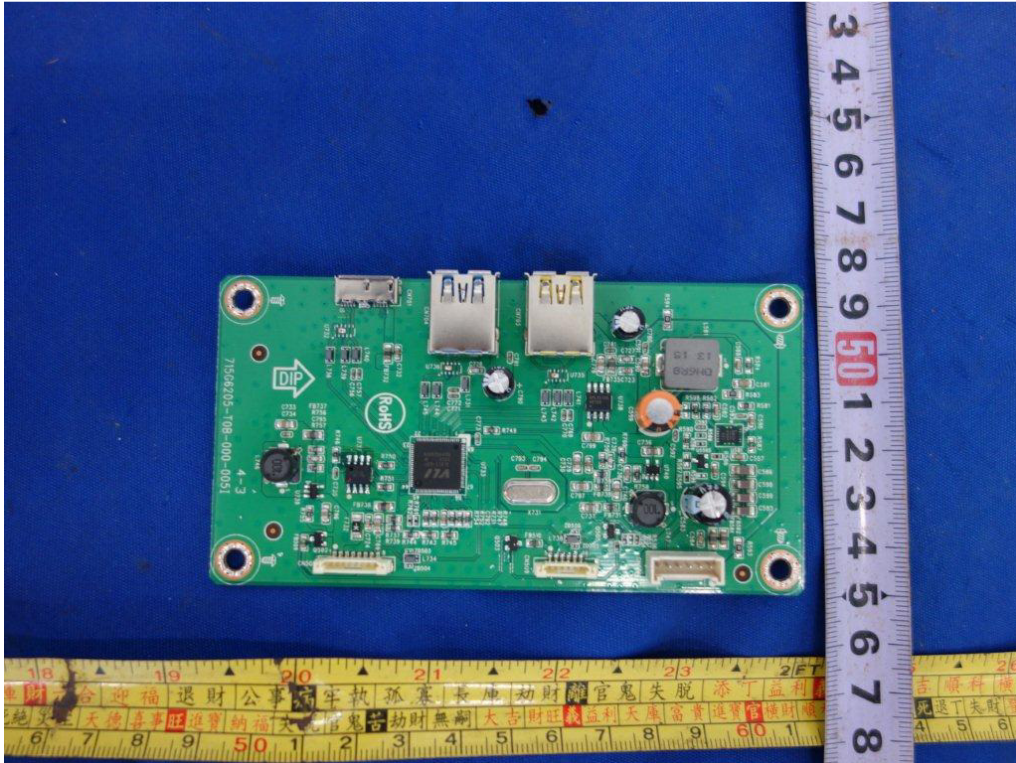

Figure 9.

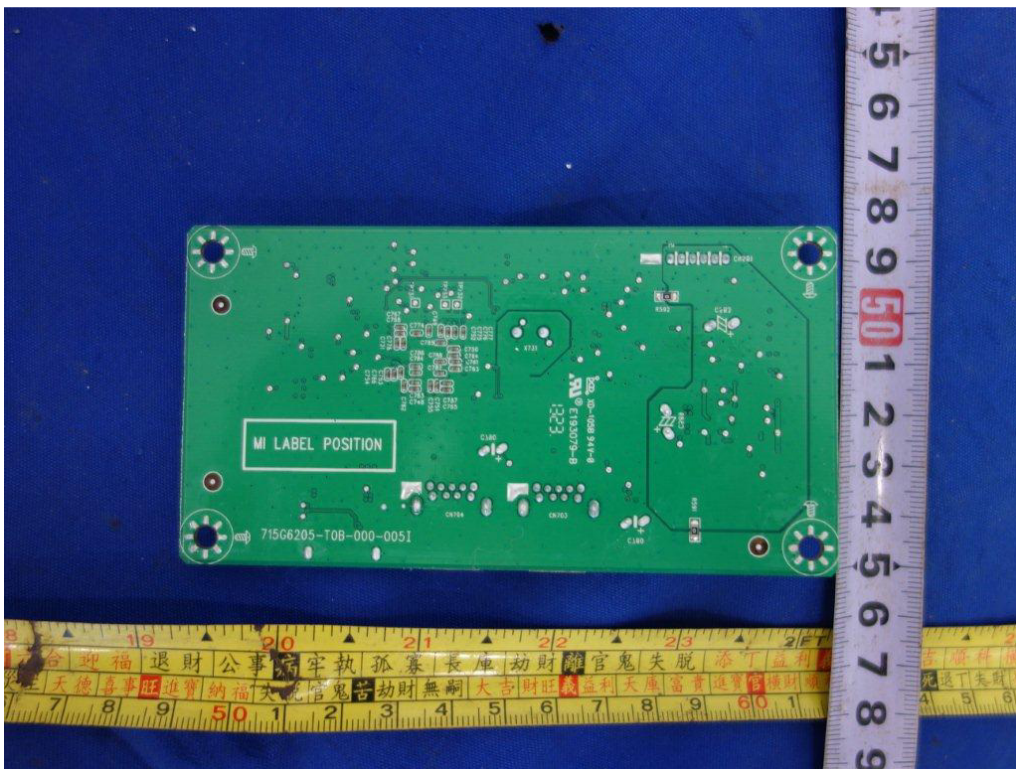

Figure 10.

Type Designation: See test report
Report Number: 17028398 001

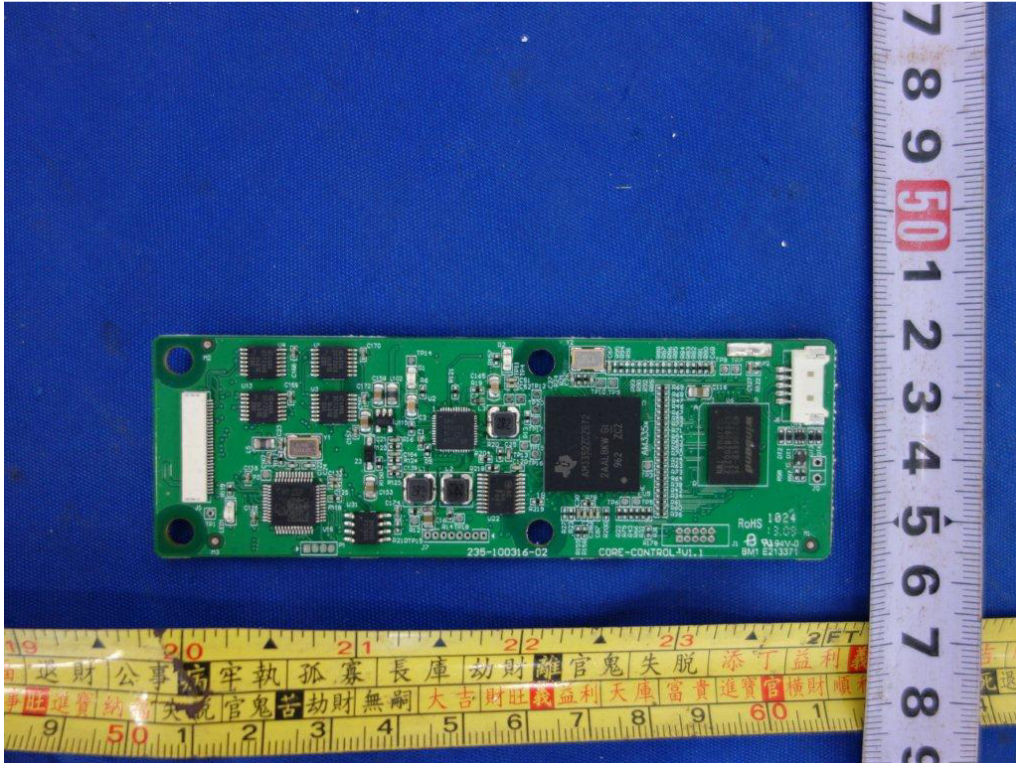

Figure 11.

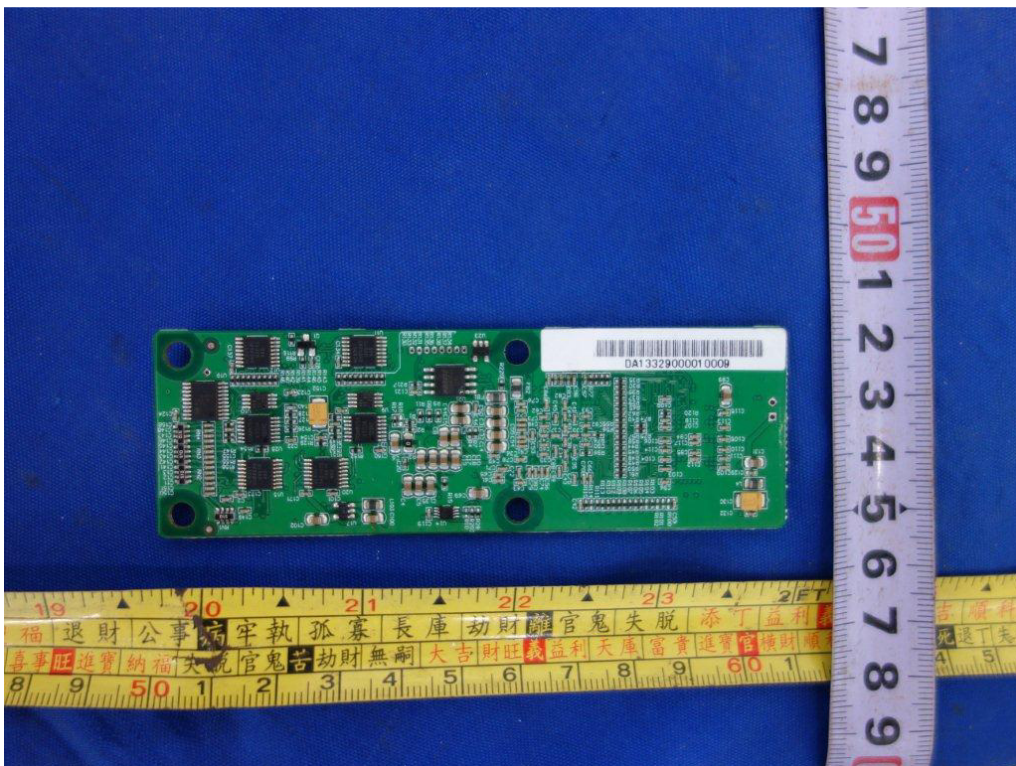

Figure 12.