

# ATTESTATION OF CONFORMITY



<b>Directive(s):</b>	<b>2004/108/EC &amp; 2014/30/EU</b>
<b>Attestation No.:</b>	<b>SECE1512064-A</b>
<b>Applicant / Holder:</b>	<b>TPV Electronics (Fujian) Co., Ltd.</b>
<b>Address:</b>	<b>Rongqiao Economic and Technological Development Zone, Fuqing City, Fujian Province, P.R. China</b>
<b>Product / Test Item:</b>	<b>LCD Monitor</b>
<b>Model / Type Reference:</b>	<b>236LM00031; E2475*** (The "*" could be any alphanumeric character including blank for marketing differentiation.)</b>

The submitted sample(s) have been tested with the following standard(s) and found to be in compliance with the essential requirements of the Directive(s):

Standard(s)	
EN 55022 : 2010/AC:2011 (Class B)	EN 55024 : 2010
EN61000-3-2:2014	IEC 61000-4-2 : 2008
EN61000-3-3:2013	IEC 61000-4-3 : 2006+A1:2007+A2:2010
CISPR 22 : 2008	IEC 61000-4-4 : 2012
AS/NZS CISPR 22 : 2009+A1(2010)	IEC 61000-4-5 : 2005
	IEC 61000-4-6 : 2008
	IEC 61000-4-8 : 2009
	IEC 61000-4-11 : 2004

The referred test report(s) show that the product fulfills the essential requirements set out in the Directive(s). On this basis, together with the manufacturer's own documented production control, the manufacturer or his European authorized representative can in his EC Declaration of Conformity verify compliance with the Directive(s). The CE marking could be affixed only when all the relevant and effective EC Directives are complied with.



**Miro Chueh / Manager**  
2015-12-25

**Cerpass Technology Corporation**

- Cerpass Technology Corporation Test Laboratory  
No.10, Ln. 2, Lianfu St., Luzhu Dist., Taoyuan City 33848, Taiwan
- Cerpass Technology (Suzhou) Co.,Ltd  
No.66, Tangzhuang Rd., Suzhou Industrial Park, Jiangsu 215006, China



# EMC TEST REPORT

Authorized under Declaration of Conformity

According to

EN 55022 : 2010/AC:2011 (Class B)	EN 55024 : 2010
EN61000-3-2:2014	IEC 61000-4-2 : 2008
EN61000-3-3:2013	IEC 61000-4-3 : 2006+A1:2007+A2:2010
CISPR 22 : 2008	IEC 61000-4-4 : 2012
AS/NZS CISPR 22 : 2009+A1(2010)	IEC 61000-4-5 : 2005
	IEC 61000-4-6 : 2008
	IEC 61000-4-8 : 2009
	IEC 61000-4-11 : 2004

Applicant	: TPV Electronics (Fujian) Co., Ltd.
Address	: Rongqiao Economic and Technological Development Zone, Fuqing City, Fujian Province, P.R. China
Equipment	: LCD Monitor
Model No.	: 236LM00031; E2475*** (The "*" could be any alphanumeric character including blank for marketing differentiation.)

## I HEREBY CERTIFY THAT :

The sample was received on Dec 17, 2015 and the testing was carried out on Dec 24, 2015 at CerpPASS Technology Corp. The test result refers exclusively to the test presented test model / sample. Without written approval of CerpPASS Technology Corp., the test report shall not be reproduced except in full.



# EMC TEST REPORT

Issued by:

**CerpPASS Technology (Suzhou) Co.,Ltd**

**No.66,Tangzhuang Road, Suzhou Industrial Park, Jiangsu 215006, China**

**Tel:86-512-6917-5888**

**Fax:86-512-6917-5666**

The test record, data evaluation & Equipment Under Test configurations represented herein are true and accurate accounts of the measurements of the samples EMC characteristics under the conditions specified in this report.

The above equipment was tested by CerpPASS Technology Corp. for compliance with the requirements of technical standards specified above under the EMC Directive **2004/108/EC & 2014/30/EU**. The results of testing in this report apply only to the product/system, which was tested. Other similar equipment will not necessarily produce the same results due to production tolerance and measurement uncertainties

Approved by:

Miro Chueh  
EMC/RF B.U. Manager

Laboratory Accreditation:

CerpPASS Technology Corporation Test Laboratory

<b>NVLAP LAB Code:</b>	<b>200954-0</b>
<b>TAF LAB Code:</b>	<b>1439</b>

CerpPASS Technology(SuZhou) Co., Ltd.

<b>NVLAP LAB Code:</b>	<b>200814-0</b>
<b>CNAS LAB Code:</b>	<b>L5515</b>



## Contents

<b>1. Summary of Test Procedure and Test Results</b>	<b>6</b>
<b>2. Immunity Testing Performance Criteria Definition</b>	<b>8</b>
<b>3. Test Configuration of Equipment under Test</b>	<b>9</b>
3.1. Feature of Equipment under Test	9
3.2. Test Manner	11
3.3. Description of Support Unit	12
3.4. General Information of Test	14
3.5. Measurement Uncertainty	15
<b>4. Test of Conducted Emission</b>	<b>17</b>
4.1. Test Limit	17
4.2. Test Procedures	18
4.3. Typical Test Setup	18
4.4. Measurement Equipment	19
4.5. Test Result and Data	20
4.6. Test Photographs of Power Port	27
<b>5. Test of Radiated Emission</b>	<b>28</b>
5.1. Test Limit	28
5.2. Test Procedures	29
5.3. Typical Test Setup	29
5.4. Measurement Equipment	30
5.5. Test Result and Data (30MHz ~ 1GHz)	31
5.6. Test Result and Data (1GHz ~ 6GHz)	43
5.7. Test Photographs (30MHz~1GHz)	55
5.8. Test Photographs (1GHz~6GHz)	57
<b>6. Harmonics Test</b>	<b>59</b>
6.1. Limits of Harmonics Current Measurement	59
6.2. Measurement Equipment	60
6.3. Test Result and Data	61
6.4. Test Photographs	63
<b>7. Voltage Fluctuations Test</b>	<b>64</b>
7.1. Test Procedure	64
7.2. Measurement Equipment	64
7.3. Test Result and Data	65
7.4. Test Photographs	67
<b>8. Electrostatic Discharge Immunity Test</b>	<b>68</b>
8.1. Test Procedure	68
8.2. Test Setup for Tests Performed in Laboratory	69
8.3. Test Severity Levels	70
8.4. Measurement Equipment	70
8.5. Test Result and Data	71
8.6. Test Photographs	72
<b>9. Radio Frequency electromagnetic field immunity test</b>	<b>73</b>



- 9.1. Test Procedure ..... 73
- 9.2. Test Severity Levels ..... 73
- 9.3. TEST SETUP ..... 74
- 9.4. Measurement Equipment ..... 75
- 9.5. Test Result and Data ..... 76
- 9.6. Test Photographs ..... 78
- 10. Electrical Fast Transient/ Burst Immunity Test ..... 79**
  - 10.1. Test Procedure ..... 79
  - 10.2. Test Severity Levels ..... 79
  - 10.3. TEST SETUP ..... 80
  - 10.4. Measurement Equipment ..... 80
  - 10.5. Test Result and Data ..... 81
  - 10.6. Test Photographs ..... 82
- 11. Surge Immunity Test ..... 83**
  - 11.1. Test Procedure ..... 83
  - 11.2. Test Severity Level ..... 83
  - 11.3. TEST SETUP ..... 84
  - 11.4. Measurement Equipment ..... 84
  - 11.5. Test Result and Data ..... 85
  - 11.6. Test Photographs ..... 86
- 12. Conduction Disturbances induced by Radio-Frequency Fields ..... 87**
  - 12.1. Test Procedure ..... 87
  - 12.2. Test Severity Levels ..... 87
  - 12.3. TEST SETUP ..... 88
  - 12.4. Measurement Equipment ..... 88
  - 12.5. Test Result and Data ..... 89
  - 12.6. Test Photographs ..... 90
- 13. Power Frequency Magnetic Field Immunity Test ..... 91**
  - 13.1. Test Setup ..... 91
  - 13.2. Test Severity Levels ..... 91
  - 13.3. Measurement Equipment ..... 91
  - 13.4. Test Result and Data ..... 92
  - 13.5. Test Photographs ..... 94
- 14. Voltage Dips and Voltage Interruptions Immunity Test Setup ..... 95**
  - 14.1. Test Conditions ..... 95
  - 14.2. TEST SETUP ..... 95
  - 14.3. Measurement Equipment ..... 95
  - 14.4. Test Result and Data ..... 96
  - 14.5. Test Photographs ..... 97
- 15. Photographs of EUT ..... 98**





## 1. Summary of Test Procedure and Test Results

First edition:

EMISSION [EN 55022: 2010/AC:2011]			
Standard	Item	Result	Remarks
EN55022: 2010/AC:2011 AS/NZS CISPR 22 : 2009+A1(2010) CISPR 22 : 2008	Conducted (Power Port)	PASS	Meet Class B Limit Minimum passing margin(AVG) is -6.58 dB at 29.7020 MHz
	Conducted (Telecom port)	N/A	N/A
	Radiated	PASS	Meets Class B Limit Minimum passing margin(peak) is -4.00 dB at 188.1100 MHz
EN 61000-3-2: 2014	Harmonic current emissions	PASS	Meet Class D Limit
EN61000-3-3:2013	Voltage fluctuations & flicker	PASS	Meets the requirements

IMMUNITY [EN 55024:2010]			
Standard	Item	Result	Remarks
IEC 61000-4-2: 2008	ESD	PASS	Meets the requirements of Performance Criterion A
IEC 61000-4-3: 2006+A1:2007+A2:2010	RS	PASS	Meets the requirements of Performance Criterion A
IEC 61000-4-4: 2012	EFT	PASS	Meets the requirements of Performance Criterion A
IEC 61000-4-5:2005	Surge	PASS	Meets the requirements of Performance Criterion A
IEC 61000-4-6:2008	CS	PASS	Meets the requirements of Performance Criterion A
IEC 61000-4-8:2009	PFMF	PASS	Meets the requirements of Performance Criterion A
IEC 61000-4-11:2004	Voltage dips & voltage variations	PASS	Meets the requirements of Voltage Dips: 1) >95% reduction Performance Criterion B 2) 30% reduction Performance Criterion B  Voltage Interruptions: 1) >95% reduction Performance Criterion C



Original:

<b>EMISSION [EN 55022: 2010/AC:2011]</b>			
<b>Standard</b>	<b>Item</b>	<b>Result</b>	<b>Remarks</b>
EN55022: 2010/AC:2011 AS/NZS CISPR 22 : 2009+A1(2010) CISPR 22 : 2008	Conducted (Power Port)	PASS	Meet Class B Limit Minimum passing margin(AVG) is -6.58 dB at 29.7020 MHz
	Conducted (Telecom port)	N/A	N/A
	Radiated	PASS	Meets Class B Limit Minimum passing margin(peak) is -4.28 dB at 224.0000 MHz
EN 61000-3-2: 2014	Harmonic current emissions	PASS	Meet Class D Limit
EN61000-3-3:2013	Voltage fluctuations & flicker	PASS	Meets the requirements

<b>IMMUNITY [EN 55024:2010]</b>			
<b>Standard</b>	<b>Item</b>	<b>Result</b>	<b>Remarks</b>
IEC 61000-4-2: 2008	ESD	PASS	Meets the requirements of Performance Criterion A
IEC 61000-4-3: 2006+A1:2007+A2:2010	RS	PASS	Meets the requirements of Performance Criterion A
IEC 61000-4-4: 2012	EFT	PASS	Meets the requirements of Performance Criterion A
IEC 61000-4-5:2005	Surge	PASS	Meets the requirements of Performance Criterion A
IEC 61000-4-6:2008	CS	PASS	Meets the requirements of Performance Criterion A
IEC 61000-4-8:2009	PFMF	PASS	Meets the requirements of Performance Criterion A
IEC 61000-4-11:2004	Voltage dips & voltage variations	PASS	Meets the requirements of Voltage Dips: 1) >95% reduction Performance Criterion B 2) 30% reduction Performance Criterion B Voltage Interruptions: 1) >95% reduction Performance Criterion C





## 2. Immunity Testing Performance Criteria Definition

<b>Criteria A:</b>	The apparatus shall continue to operate as intended without operator intervention. No degradation of performance or loss of function is allowed below a performance level specified by the manufacturer, when the apparatus is used as intended. The performance level may be replaced by a permissible loss of performance. If the manufacturer does not specify the minimum performance level or the permissible performance loss, then either of these may be derived from the product description and documentation, and by what the user may reasonably expect from the equipment if used as intended.
<b>Criteria B:</b>	After test, the apparatus shall continue to operate as intended without operator intervention. No degradation of performance or loss of function is allowed, after the application of the phenomenon below a performance level specified by the manufacturer, when the apparatus is used as intended. The performance level may be replaced by a permissible loss of performance.  During the test, degradation of performance is however allowed. However, no change of operating state if stored data is allowed to persist after the test. If the manufacturer does not specify the minimum performance level or the permissible performance loss, then either of these may be derived from the product description and documentation, and by what the user may reasonably expect from the equipment if used as intended.
<b>Criteria C:</b>	Temporary loss of function is allowed, provided the functions is self-recoverable or can be restored by the operation of controls by the user in accordance with the manufacturer instructions.  Functions, and/or information stored in non-volatile memory, or protected by a battery backup, shall not be lost.



### 3. Test Configuration of Equipment under Test

#### 3.1. Feature of Equipment under Test

First edition:

<b>Product Name:</b>	LCD Monitor
<b>Model Name:</b>	236LM00031; E2475*** (The "*" could be any alphanumeric character including blank for marketing differentiation.)
<b>Housing material:</b>	Plastic case
<b>EUT Highest Frequency:</b>	148.5MHz
<b>EUT Power Rating:</b>	Input:100-240V,50-60Hz 3Pin Power Port
<b>AC Power Cord Type:</b>	Non-shielded, 1.2m&1.5m&1.8m

#### I/O PORT

I/O PORT TYPE	Quantity
1). VGA Port	1
2). HDMI Port	1
3). Audio in Port	1
4). Audio out Port	1
5). DVI port	1
6). AC Power Port	1



Original:

<b>Product Name:</b>	LCD Monitor
<b>Model Name:</b>	236LM00031;E2475PWJ
<b>Housing material:</b>	Plastic case
<b>EUT Highest Frequency:</b>	148.5MHz
<b>EUT Power Rating:</b>	Input:100-240V,50-60Hz 3Pin Power Port
<b>AC Power Cord Type:</b>	Non-shielded, 1.2m&1.5m&1.8m

**I/O PORT**

<b>I/O PORT TYPE</b>	<b>Quantity</b>
7). VGA Port	1
8). HDMI Port	1
9). Audio in Port	1
10). Audio out Port	1
11). DVI port	1
12). AC Power Port	1



### 3.2. Test Manner

- a. During testing, the interface cables and equipment positions were varied according to Europe Standard EN55022 Class B.
- b. An executive program, “MyHwin” under Win 7, which generates a complete line of continuously repeating “H” pattern was used as the test software.

The program was executed as follows:

- 1. Turn on the power of all equipment.
- 2. The EUT reads the test program from the hard disk drive and runs it.
- 3. PC sends “H” messages to the EUT, and the monitor displays “H” patterns on the screen.
- 4. Repeat the steps from 2 to 3.

- c. The complete test system included PC, USB Keyboard, USB Mouse, Earphone and EUT for EMI&EMS test.

First edition:

- d. The test modes as follow:

- Test Mode 1: Full system (VGA mode 1920\*1080@60Hz)
- Test Mode 2: Full system (VGA mode 1280\*1024@75Hz)
- Test Mode 3: Full system (VGA mode 800\*600@60Hz)
- Test Mode 4: Full system (HDMI mode 1920\*1080@60Hz)
- Test Mode 5: Full system (HDMI mode 1280\*1024@75Hz)
- Test Mode 6: Full system (HDMI mode 800\*600@60Hz)
- Test Mode 7: Full system (DVI mode 1920\*1080@60Hz)
- Test Mode 8: Full system (DVI mode 1280\*1024@75Hz)
- Test Mode 9: Full system (DVI mode 800\*600@60Hz)
- Test Mode 10: Full system (1080P from DVD mode)

“Test mode 1, 4, 7” were reported as final data.

Original:

- e. The test modes as follow:

- Test Mode 1: Full system (VGA mode 1920\*1080@60Hz) for Horizontal
- Test Mode 2: Full system (VGA mode 1280\*1024@75Hz) for Horizontal
- Test Mode 3: Full system (VGA mode 800\*600@60Hz) for Horizontal
- Test Mode 4: Full system (VGA mode 1920\*1080@60Hz) for Vertical
- Test Mode 5: Full system (DVI mode 1920\*1080@60Hz) for Horizontal
- Test Mode 6: Full system (DVI mode 1280\*1024@75Hz) for Horizontal
- Test Mode 7: Full system (DVI mode 800\*600@60Hz) for Horizontal
- Test Mode 8: Full system (DVI mode 1920\*1080@60Hz) for Vertical
- Test Mode 9: Full system (HDMI mode 1920\*1080@60Hz) for Horizontal



Test Mode 10: Full system (HDMI mode 1280\*1024@75Hz) for Horizontal  
 Test Mode 11: Full system (HDMI mode 800\*600@60Hz) for Horizontal  
 Test Mode 12: Full system (HDMI mode 1920\*1080@60Hz) for Vertical  
 Test Mode 13: Full system (1080P from DVD mode) for Horizontal  
 “Test mode 1, 5, 9” were reported as final data.

- f. The maximum operating frequency is above 108MHz, the test frequency range is from 1GHz to 6GHz.

### 3.3. Description of Support Unit

First edition:

Device	Manufacturer	Model No.	Description
PC	HP	HP Compaq Elite 8200 MTPC	Non-Shielded ,1.8m(R33001)
USB Keyboard	DELL	SK-8115	T3A002
USB Mouse	DELL	G0K02XYK	R41108
Earphone	SALAR	V18	N/A

Use Cable:

Cable	Quantity	Description
USB Cable	1	Shielded, 1.8m, with one ferrite core bonded
USB Cable	1	Shielded, 1.2m
Audio out Cable	1	Non-Shielded, 1.8m
HDMI Cable	1	Shielded, 1.2m&1.5m&1.8m
DVI Cable	1	Shielded, 1.2m&1.5m&1.8m , with two ferrite core bonded
VGA Cable	1	Shielded, 1.2m&1.5m&1.8m , with two ferrite core bonded
Audio in Cable	1	Shielded, 1.2m&1.5m&1.8m

Original:

Device	Manufacturer	Model No.	Description
PC	HP	HP Compaq Elite 8200 MTPC	Non-Shielded ,1.8m(R33001)
USB Keyboard	DELL	SK-8115	T3A002
USB Mouse	DELL	G0K02XYK	R41108
Earphone	SALAR	V18	N/A



Use Cable:

Cable	Quantity	Description
USB Cable	1	Shielded, 1.8m, with one ferrite core bonded
USB Cable	1	Shielded, 1.2m
Audio out Cable	1	Non-Shielded, 1.8m
HDMI Cable	1	Shielded, 1.2m&1.5m&1.8m
DVI Cable	1	Shielded, 1.2m&1.5m&1.8m , with two ferrite core bonded
VGA Cable	1	Shielded, 1.2m&1.5m&1.8m , with two ferrite core bonded
Audio in Cable	1	Shielded, 1.2m&1.5m&1.8m



3.4. General Information of Test

<input type="checkbox"/>	Test Site	<p><b>CerpPASS Technology Corporation Test Laboratory</b>                      Address: No.10, Ln. 2, Lianfu St., Luzhu Dist., Taoyuan City 33848, Taiwan (R.O.C.)                      Tel:+886-3-3226-888                      Fax:+886-3-3226-881                      Address: No.68-1, Shihbachongsi, Shihding Township, New Taipei City 223, Taiwan, R.O.C.                      Tel: +886-2-2663-8582</p>
	FCC	TW1079, TW1061,390316, 228391, 641184
	IC	4934B-1, 4934E-1, 4934E-2
	VCCI	T-2205 for Telecommunication Test C-4663 for Conducted emission test R-3428, R-4218 for Radiated emission test G-812, G-813 for radiated disturbance above 1GHz
<input checked="" type="checkbox"/>	Test Site	<p><b>CerpPASS Technology (Suzhou) Co.,Ltd</b>                      Address: No.66,Tangzhuang Road, Suzhou Industrial Park, Jiangsu 215006, China                      Tel: +86-512-6917-5888                      Fax: +86-512-6917-5666</p>
	FCC	331395
	IC	7290A-1, 7290A-2
	VCCI	T-1945 for Telecommunication Test C-2919 for Conducted emission test R-2670 for Radiated emission test G-227 for radiated disturbance above 1GHz
Frequency Range Investigated:		Conducted: from 150kHz to 30 MHz Radiation: from 30 MHz to 6000MHz
Test Distance :		The test distance of radiated emission below 1GHz from antenna to EUT is 10 M. The test distance of radiated emission above 1GHz from antenna to EUT is 3 M.



### 3.5. Measurement Uncertainty

Where relevant, the following measurement uncertainty levels have been estimated for tests performed on the EUT as specified in CISPR 16-4-2:

Measurement	Frequency	Uncertainty
Conducted emissions(LINE)	9KHz-30MHz	+/- 0.6888 dB
Conducted emissions(NEUTRAL)	9KHz-30MHz	+/- 0.7002 dB

Measurement	Polarity	Frequency	Uncertainty
Radiated emissions (below 1GHz)	H	30MHz ~ 200MHz	+/- 4.0677dB
		200MHz ~1000MHz	+/- 3.9131dB
	V	30MHz ~ 200MHz	+/- 4.0678dB
		200MHz ~1000MHz	+/- 3.9142dB
Radiated emissions (above 1GHz)	H	1000MHz ~18000MHz	+/- 3.8904 dB
		18000MHz ~40000MHz	+/-3.9356dB
	V	1000MHz ~18000MHz	+/- 3.8896dB
		18000MHz ~40000MHz	+/- 3.8766dB

Measurement	Uncertainty
ESD—Rise time tr	6.4%
ESD—Peak current Ip	6%
ESD—Current at 30 ns	6%
ESD—Current at 60 ns	6%
ESD- Charging voltage	1%
RS above 1GHz	±2.28dB
RS under 1GHz	±3.62dB
EFT—Rise time tr	4%
EFT—Peak current Ip	4%
EFT—Current	4%
Surge—Rise time tr	4%
Surge—Peak current Ip	4%





Surge—Current	4%
CS-CND	±0.80dB
CS-Clamp	±1.06dB

This uncertainty represents an expanded uncertainty expressed at approximately the 95% confidence level using a coverage factor of k=2.

Consistent with industry standard (e.g. CISPR 22: 2008, clause 11, Measurement Uncertainty) determining compliance with the limits shall be based on the results of the compliance measurement. Consequently the measured emissions being less than the maximum allowed emission result in this being a compliant test or passing test.

## 4. Test of Conducted Emission

### 4.1. Test Limit

Conducted Emissions were measured from 150 kHz to 30 MHz with a bandwidth of 9 kHz and return leads of the EUT according to the methods defined in European Standard EN 55022. The EUT was placed on a nonmetallic stand in a shielded room 0.8 meters above the ground plane as shown in section 4.2. The interface cables and equipment positioning were varied within limits of reasonable applications to determine the position producing maximum conducted emissions.

**Table 1 Conducted Emission Limits (dB $\mu$ V):**

Frequency range (MHz)	Class A Equipment		Class B Equipment	
	Quasi Peak	Average	Quasi Peak	Average
0.15 to 0.50	79	66	66 to 56	56 to 46
0.50 to 5	73	60	56	46
5. to 30.	73	60	60	50

Note 1: The lower limits shall apply at the transition frequencies.  
 Note 2: The limit decreases linearly with the logarithm of the frequency in the range 0.15 MHz to 0.5MHz.

**Table 2 - Limits of conducted common mode (asymmetric mode) disturbance at telecommunication ports in the frequency range 0.15 MHz to 30 MHz(dB( $\mu$ V)).**

Frequency range (MHz)	Class A Equipment				Class B Equipment			
	Voltage		Current		Voltage		Current	
	Quasi Peak	Avg.	Quasi Peak	Avg.	Quasi Peak	Avg.	Quasi Peak	Avg.
0.15 to 0.5	97~ 87	84~74	53~43	40~30	84~74	74~64	40~30	30~20
0.5 to 5	87	74	43	30	74	64	30	20
5 to 30	87	74	43	30	74	64	30	20

Note 1: The limits decrease linearly with the logarithm of the frequency in the range 0.15 to 0.5 MHz.  
 Note 2 : The current and voltage disturbance limits are derived for use with an impedance stabilization network (ISN) which presents a common mode (asymmetric mode) impedance of 150 $\Omega$  to the telecommunication under test (conversion factor is  $20 \log_{10} 150/1 = 44\text{dB}$ ).

## 4.2. Test Procedures

- a. The EUT was placed on a desk 0.8 meters height from the metal ground plane and 0.4 meter from the conducting wall of the shielding room and it was kept at least 0.8 meters from any other grounded conducting surface.
- b. Connect EUT to the power mains through a line impedance stabilization network (LISN).
- c. All the support units are connecting to the other LISN.
- d. The LISN provides 50 ohm coupling impedance for the measuring instrument.
- e. The CISPR states that a 50 ohm, 50 micro-Henry LISN should be used.
- f. Both sides of AC line were checked for maximum conducted interference.
- g. The frequency range from 150 kHz to 30 MHz was searched
- h. Set the test-receiver system to Peak Detect Function and Specified Bandwidth with Maximum Hold Mode.

## 4.3. Typical Test Setup

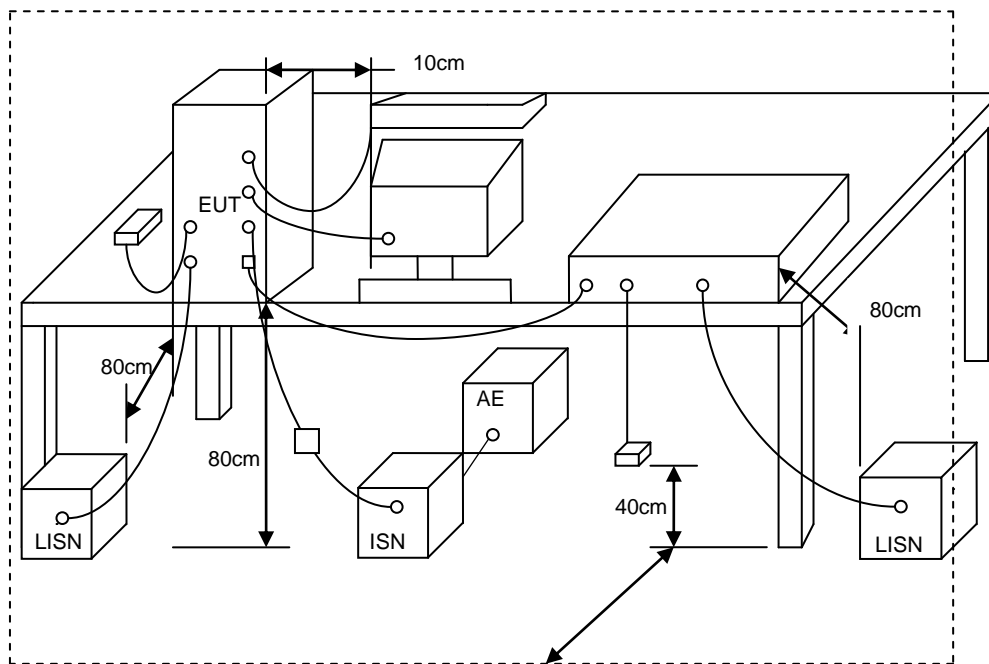



#### 4.4. Measurement Equipment

Instrument/Ancillary	Manufacturer	Model No.	Serial No.	Calibration Date	Valid Date.
Test Receiver	R&S	ESCI	100565	2015.03.29	2016.03.28
AMN	R&S	ESH2-Z5	100182	2015.09.06	2016.09.05
Two-Line V-Network	R&S	ENV216	100325	/	/
ISN	FCC	FCC-TLISN-T2-02	20379	2015.03.29	2016.03.28
ISN	FCC	FCC-TLISN-T4-02	20380	2015.03.29	2016.03.28
ISN	FCC	FCC-TLISN-T8-02	20381	2015.03.29	2016.03.28
ISN	TESEQ	ISN ST08	30175	2015.03.29	2016.03.28
Current Probe	R&S	EZ-17	100303	2015.03.29	2016.03.28
Passive Voltage Probe	R&S	ESH2-Z3	100026	2015.03.29	2016.03.28
Pulse Limiter	R&S	ESH3-Z2	100529	2015.03.29	2016.03.28
Temperature/ Humidity Meter	Zhicheng	ZC1-11	CEP-TH-004	2015.04.02	2016.04.01
EZ-EMC	Fala	Ver CT3A1	N/A	N/A	N/A



### 4.5. Test Result and Data

#### 4.5.1 Conducted Emission for Power Port Test Data

Test Mode :	Mode 1: Full system (VGA mode 1920*1080@60Hz) for Horizontal		
AC Power :	AC 230V/50Hz	Phase :	LINE
Equipment :	LCD Monitor	Model No :	236LM00031
Temperature :	20°C	Humidity :	55%
Pressure(mbar) :	1001	Date:	2015/12/15

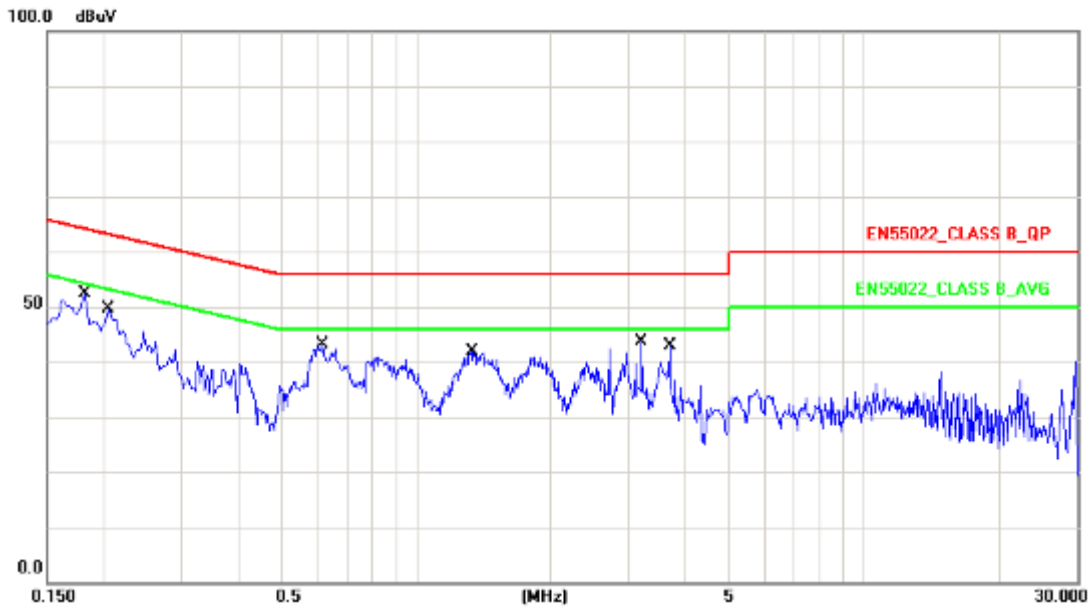

No.	Frequency (MHz)	Factor (dB)	Reading (dBuV)	Level (dBuV)	Limit (dBuV)	Margin (dB)	Detector
1	0.1819	10.25	31.53	41.78	64.39	-22.61	QP
2	0.1819	10.25	11.77	22.02	54.39	-32.37	AVG
3	0.2060	10.25	35.81	46.06	63.36	-17.30	QP
4	0.2060	10.25	28.07	38.32	53.36	-15.04	AVG
5	0.6180	10.31	29.31	39.62	56.00	-16.38	QP
6	0.6180	10.31	23.01	33.32	46.00	-12.68	AVG
7	1.3340	10.30	27.38	37.68	56.00	-18.32	QP
8	1.3340	10.30	21.79	32.09	46.00	-13.91	AVG
9	3.2020	10.30	20.73	31.03	56.00	-24.97	QP
10	3.2020	10.30	11.79	22.09	46.00	-23.91	AVG
11	3.6860	10.29	20.74	31.03	56.00	-24.97	QP
12	3.6860	10.29	14.64	24.93	46.00	-21.07	AVG

Note: Measurement Level = Reading Level + Correct Factor



Test Mode :	Mode 1: Full system (VGA mode 1920*1080@60Hz) for Horizontal		
AC Power :	AC 230V/50Hz	Phase :	NEUTRAL
Equipment :	LCD Monitor	Model No :	236LM00031
Temperature :	20°C	Humidity :	55%
Pressure(mbar) :	1001	Date:	2015/12/15

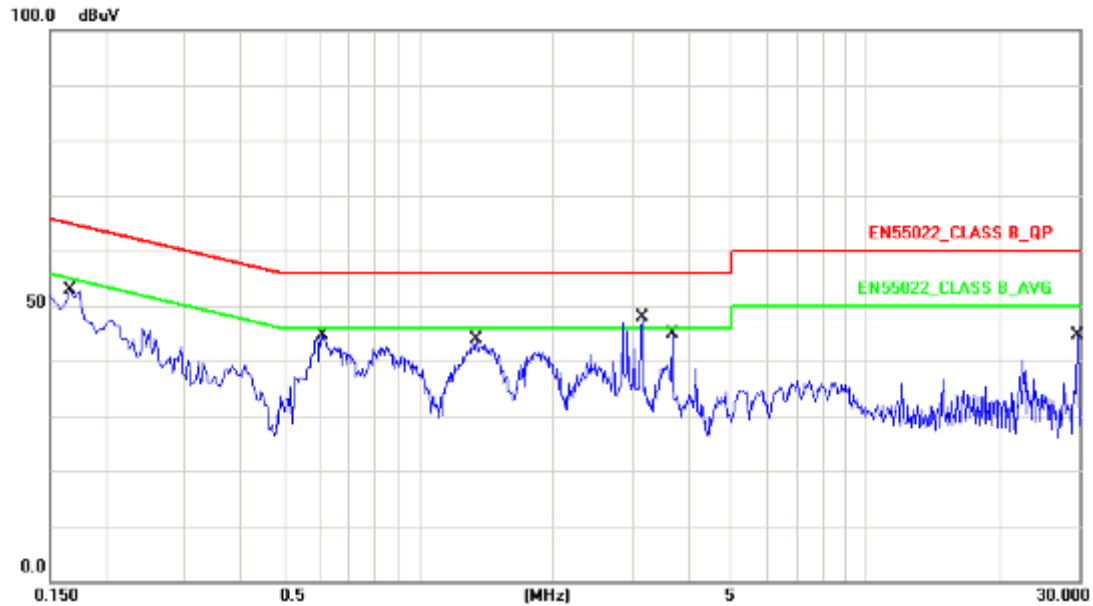

No.	Frequency (MHz)	Factor (dB)	Reading (dBuV)	Level (dBuV)	Limit (dBuV)	Margin (dB)	Detector
1	0.1660	10.20	39.33	49.53	65.15	-15.62	QP
2	0.1660	10.20	34.42	44.62	55.15	-10.53	AVG
3	0.6100	10.27	31.94	42.21	56.00	-13.79	QP
4	0.6100	10.27	23.50	33.77	46.00	-12.23	AVG
5	1.3500	10.41	28.79	39.20	56.00	-16.80	QP
6	1.3500	10.41	23.07	33.48	46.00	-12.52	AVG
7	3.1580	10.51	20.64	31.15	56.00	-24.85	QP
8	3.1580	10.51	14.29	24.80	46.00	-21.20	AVG
9	3.6940	10.53	21.39	31.92	56.00	-24.08	QP
10	3.6940	10.53	15.37	25.90	46.00	-20.10	AVG
11	29.7020	10.97	37.41	48.38	60.00	-11.62	QP
12	29.7020	10.97	32.40	43.37	50.00	-6.63	AVG

Note: Measurement Level = Reading Level + Correct Factor



Test Mode :	Mode 5: Full system (DVI mode 1920*1080@60Hz) for Horizontal		
AC Power :	AC 230V/50Hz	Phase :	LINE
Equipment :	LCD Monitor	Model No :	236LM00031
Temperature :	20°C	Humidity :	55%
Pressure(mbar) :	1001	Date:	2015/12/15

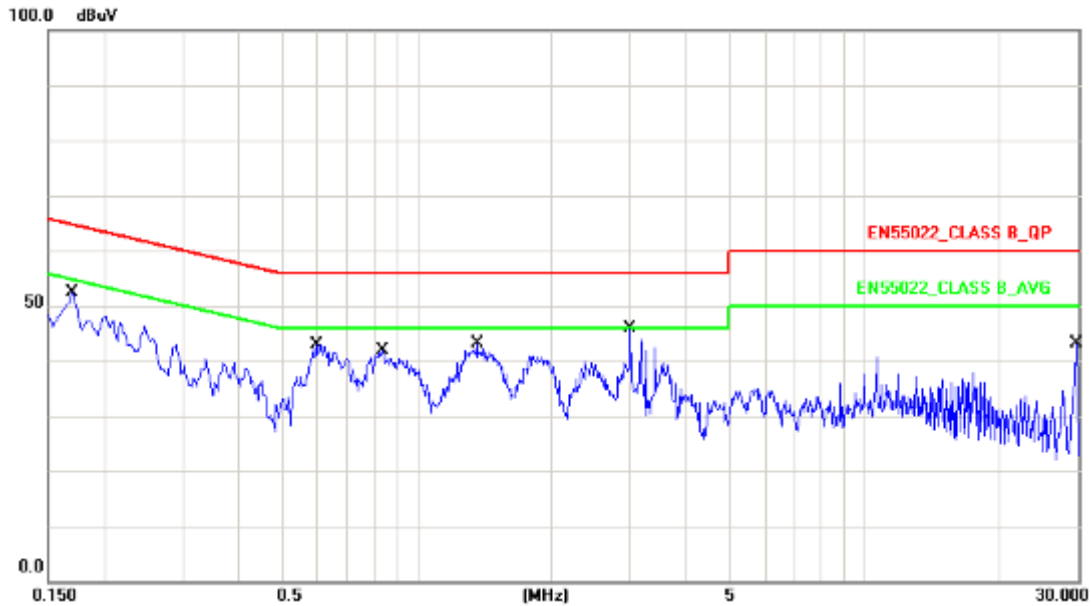

No.	Frequency (MHz)	Factor (dB)	Reading (dBuV)	Level (dBuV)	Limit (dBuV)	Margin (dB)	Detector
1	0.1700	10.24	35.81	46.05	64.96	-18.91	QP
2	0.1700	10.24	28.64	38.88	54.96	-16.08	AVG
3	0.5980	10.30	29.57	39.87	56.00	-16.13	QP
4	0.5980	10.30	17.47	27.77	46.00	-18.23	AVG
5	0.8380	10.32	28.46	38.78	56.00	-17.22	QP
6	0.8380	10.32	20.88	31.20	46.00	-14.80	AVG
7	1.3619	10.30	28.37	38.67	56.00	-17.33	QP
8	1.3619	10.30	22.74	33.04	46.00	-12.96	AVG
9	3.0020	10.30	24.44	34.74	56.00	-21.26	QP
10	3.0020	10.30	15.85	26.15	46.00	-19.85	AVG
11	29.7020	10.57	36.69	47.26	60.00	-12.74	QP
12	29.7020	10.57	31.69	42.26	50.00	-7.74	AVG

Note: Measurement Level = Reading Level + Correct Factor



Test Mode :	Mode 5: Full system (DVI mode 1920*1080@60Hz) for Horizontal		
AC Power :	AC 230V/50Hz	Phase :	NEUTRAL
Equipment :	LCD Monitor	Model No :	236LM00031
Temperature :	20°C	Humidity :	55%
Pressure(mbar) :	1001	Date:	2015/12/15

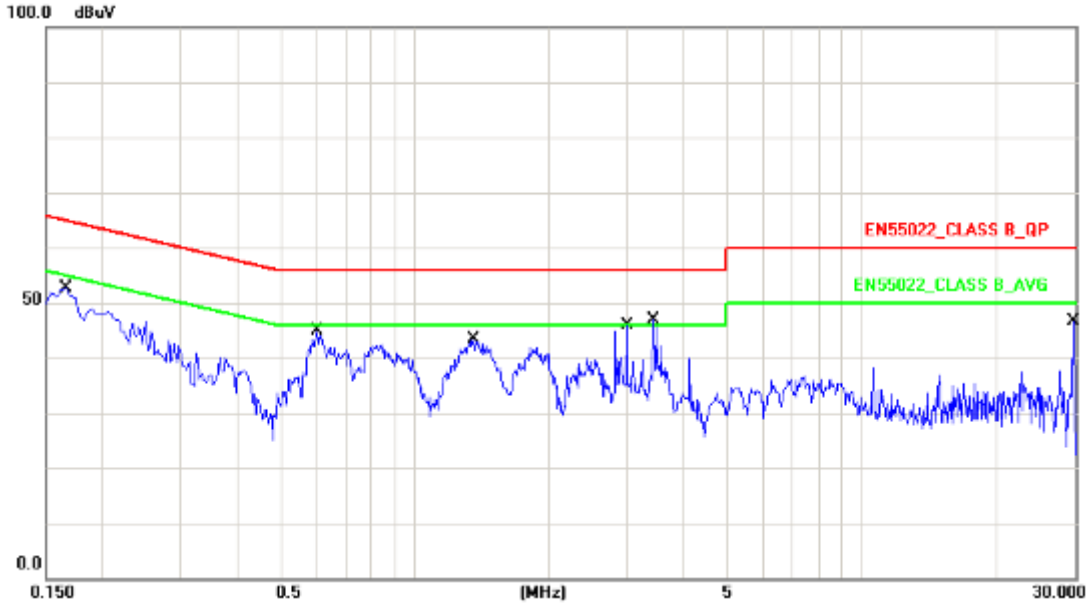

No.	Frequency (MHz)	Factor (dB)	Reading (dBuV)	Level (dBuV)	Limit (dBuV)	Margin (dB)	Detector
1	0.1660	10.20	39.73	49.93	65.15	-15.22	QP
2	0.1660	10.20	34.56	44.76	55.15	-10.39	AVG
3	0.6060	10.27	31.34	41.61	56.00	-14.39	QP
4	0.6060	10.27	20.63	30.90	46.00	-15.10	AVG
5	1.3580	10.42	28.74	39.16	56.00	-16.84	QP
6	1.3580	10.42	23.12	33.54	46.00	-12.46	AVG
7	2.9780	10.51	28.57	39.08	56.00	-16.92	QP
8	2.9780	10.51	16.19	26.70	46.00	-19.30	AVG
9	3.4180	10.52	21.20	31.72	56.00	-24.28	QP
10	3.4180	10.52	14.11	24.63	46.00	-21.37	AVG
11	29.7020	10.97	37.47	48.44	60.00	-11.56	QP
12	29.7020	10.97	32.45	43.42	50.00	-6.58	AVG

Note: Measurement Level = Reading Level + Correct Factor





Test Mode :	Mode 9: Full system (HDMI mode 1920*1080@60Hz) for Horizontal		
AC Power :	AC 230V/50Hz	Phase :	LINE
Equipment :	LCD Monitor	Model No :	236LM00031
Temperature :	20°C	Humidity :	55%
Pressure(mbar) :	1001	Date:	2015/12/15

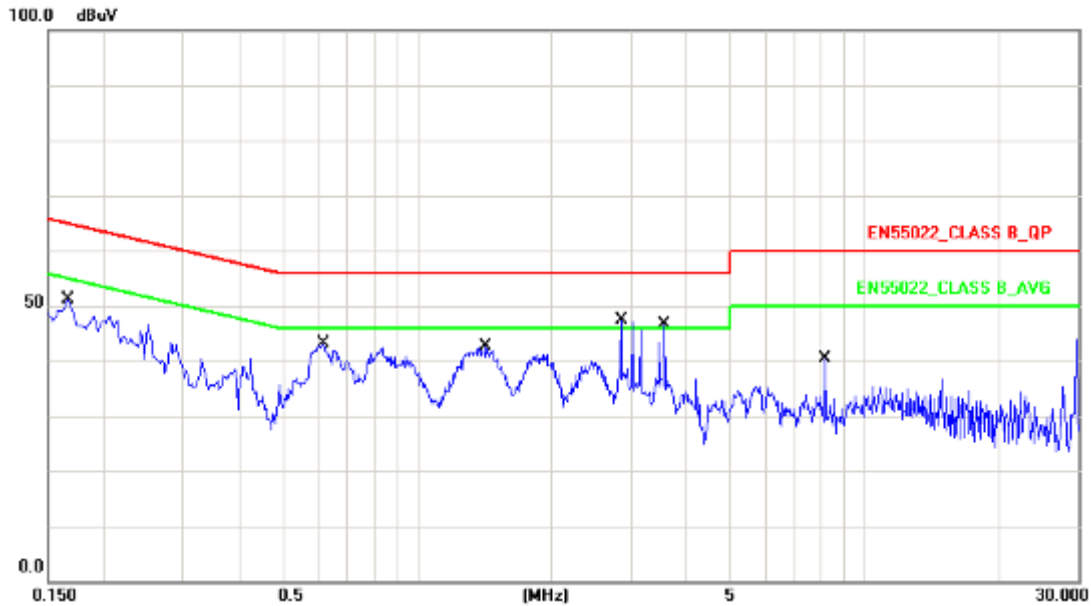

No.	Frequency (MHz)	Factor (dB)	Reading (dBuV)	Level (dBuV)	Limit (dBuV)	Margin (dB)	Detector
1	0.1660	10.24	37.13	47.37	65.15	-17.78	QP
2	0.1660	10.24	30.86	41.10	55.15	-14.05	AVG
3	0.6180	10.31	29.87	40.18	56.00	-15.82	QP
4	0.6180	10.31	23.76	34.07	46.00	-11.93	AVG
5	1.4299	10.30	27.61	37.91	56.00	-18.09	QP
6	1.4299	10.30	22.24	32.54	46.00	-13.46	AVG
7	2.8620	10.30	23.43	33.73	56.00	-22.27	QP
8	2.8620	10.30	13.63	23.93	46.00	-22.07	AVG
9	3.5700	10.29	23.57	33.86	56.00	-22.14	QP
10	3.5700	10.29	17.90	28.19	46.00	-17.81	AVG
11	8.1860	10.32	14.13	24.45	60.00	-35.55	QP
12	8.1860	10.32	6.70	17.02	50.00	-32.98	AVG

Note: Measurement Level = Reading Level + Correct Factor



Test Mode :	Mode 9: Full system (HDMI mode 1920*1080@60Hz) for Horizontal		
AC Power :	AC 230V/50Hz	Phase :	NEUTRAL
Equipment :	LCD Monitor	Model No :	236LM00031
Temperature :	20°C	Humidity :	55%
Pressure(mbar) :	1001	Date:	2015/12/15

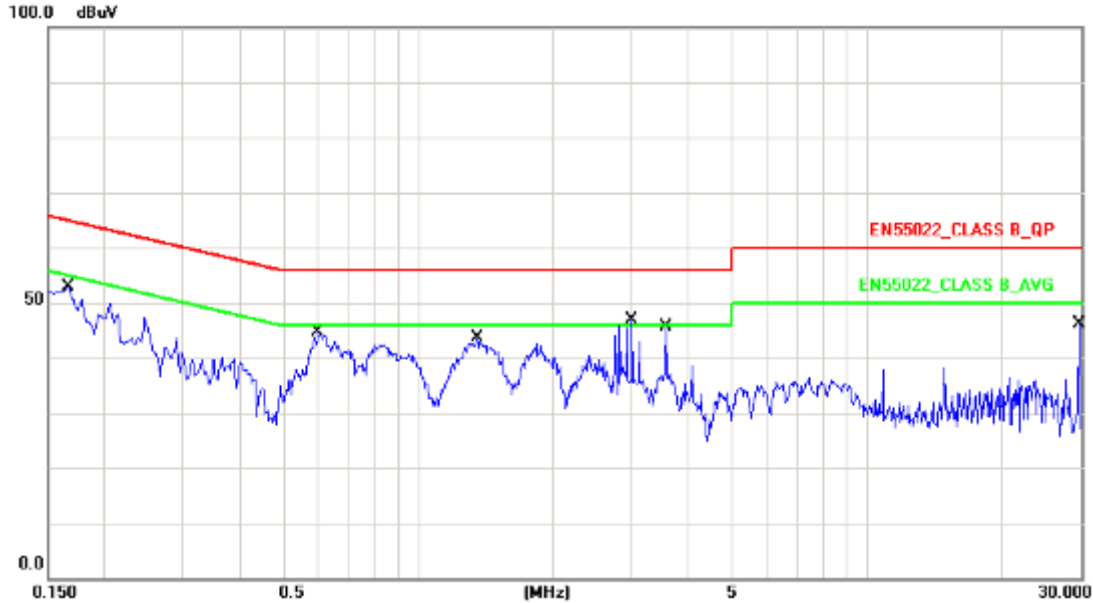

No.	Frequency (MHz)	Factor (dB)	Reading (dBuV)	Level (dBuV)	Limit (dBuV)	Margin (dB)	Detector
1	0.1660	10.20	39.65	49.85	65.15	-15.30	QP
2	0.1660	10.20	34.53	44.73	55.15	-10.42	AVG
3	0.5980	10.26	31.00	41.26	56.00	-14.74	QP
4	0.5980	10.26	18.52	28.78	46.00	-17.22	AVG
5	1.3580	10.42	28.88	39.30	56.00	-16.70	QP
6	1.3580	10.42	23.24	33.66	46.00	-12.34	AVG
7	3.0020	10.51	27.55	38.06	56.00	-17.94	QP
8	3.0020	10.51	16.32	26.83	46.00	-19.17	AVG
9	3.5740	10.53	23.96	34.49	56.00	-21.51	QP
10	3.5740	10.53	18.08	28.61	46.00	-17.39	AVG
11	29.7020	10.97	37.34	48.31	60.00	-11.69	QP
12	29.7020	10.97	32.33	43.30	50.00	-6.70	AVG

Note: Measurement Level = Reading Level + Correct Factor

Test engineer: Seben



#### **4.5.2 Conducted Emission for Telecommunication Port Test Data**

Note: The EUT doesn't have the telecommunication port.



#### 4.6. Test Photographs of Power Port

Front View



Rear View





## 5. Test of Radiated Emission

### 5.1. Test Limit

The EUT shall meet the limits of below Table when measured at the measuring distance R in accordance with the methods described in European Standard EN 55022 Clause 10. If the reading on the measuring receiver shows fluctuations close to the limit, the reading shall be observed for at least 15 s at each measurement frequency; the highest reading shall be recorded, with the exception of any brief isolated high reading, which shall be ignored.

**Table 1 – Limits for radiated disturbance at a measuring distance of 10 m (dB(μV/m))**

Frequency range(MHz)	Class A Equipment		Class B Equipment	
	Quasi-peak		Quasi-peak	
30 to 230	40		30	
230 to 1000	47		37	

NOTE 1 The lower limit shall apply at the transition frequency.  
NOTE 2 Additional provisions may be required for cases where interference occurs.

The EUT shall meet the limits of below Table when measured in accordance with the method described in European Standard EN 55022 Clause 10 and the conditional testing procedure described below.

**Table 2 – Limits for radiated disturbance at a measuring distance of 3 m (dB (μV/m))**

Frequency range (GHz)	Class A Equipment		Class B Equipment	
	Avg.	Peak	Avg.	Peak
1 to 3	56	76	50	70
3 to 6	60	80	54	74

NOTE The lower limit applies at the transition frequency.

• **Conditional testing procedure:**

The highest internal source of an EUT is defined as the highest frequency generated or used within the EUT or on which the EUT operates or tunes.

If the highest frequency of the internal sources of the EUT is less than 108 MHz, the measurement shall only be made up to 1 GHz.

If the highest frequency of the internal sources of the EUT is between 108 MHz and 500 MHz, the measurement shall only be made up to 2 GHz.

If the highest frequency of the internal sources of the EUT is between 500 MHz and 1 GHz, the measurement shall only be made up to 5 GHz.

If the highest frequency of the internal sources of the EUT is above 1 GHz, the measurement shall be made up to 5 times the highest frequency or 6 GHz, whichever is less.

## 5.2. Test Procedures

- a. The EUT was placed on a rotatable table top 0.8 meter above ground.
- b. The EUT was set 3/10 meters from the interference receiving antenna which was mounted on the top of a variable height antenna tower.
- c. The table was rotated 360 degrees to determine the position of the highest radiation.
- d. The antenna is a half wave dipole and its height is varied between one meter and four meters above ground to find the maximum value of the field strength both horizontal polarization and vertical polarization of the antenna are set to make the measurement.
- e. For each suspected emission the EUT was arranged to its worst case and then tune the antenna tower (from 1 M to 4 M) and turn table (from 0 degree to 360 degrees) to find the maximum reading.
- f. Set the test-receiver system to Peak Detect Function and specified bandwidth with Maximum Hold Mode.
- g. If the emission level of the EUT in peak mode was 3 dB lower than the limit specified, then testing will be stopped and peak values of EUT will be reported, otherwise, the emissions which do not have 3 dB margin will be repeated one by one using the quasi-peak method and reported.

## 5.3. Typical Test Setup

### Below 1GHz Test Setup

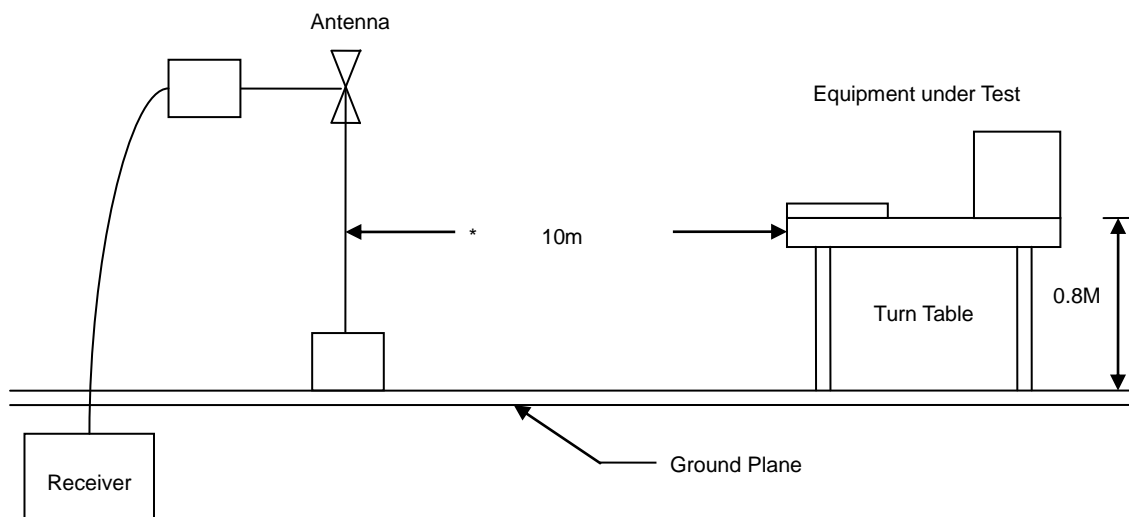

Above 1GHz Test Setup

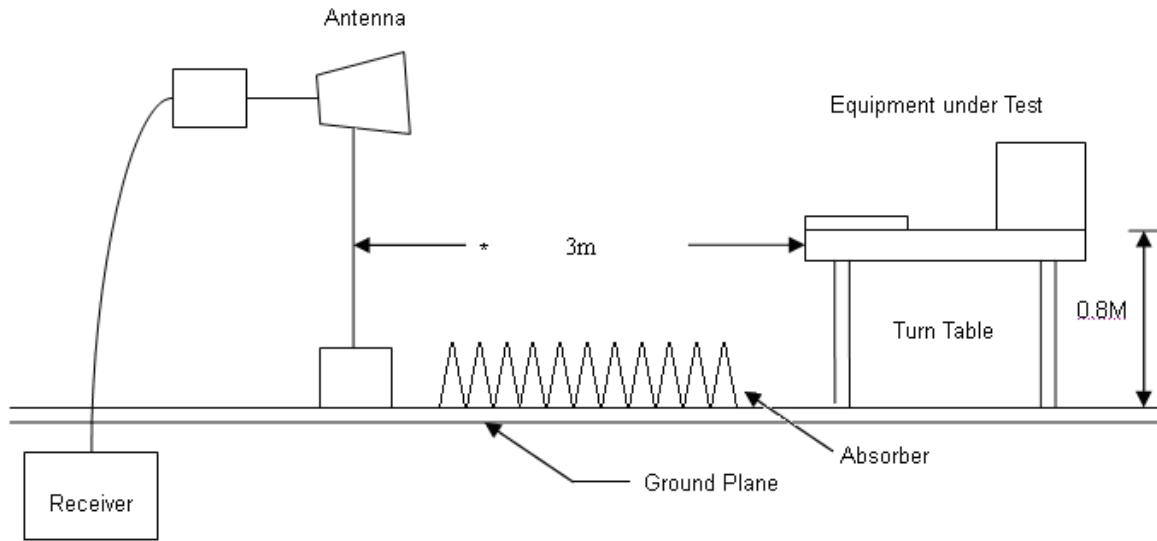

5.4. Measurement Equipment

Instrument/Ancillary	Manufacturer	Model No.	Serial No.	Calibration Date	Valid Date.
EMI Test Receiver	R&S	ESC17	100968	2015.03.29	2016.03.28
Preamplifier	Agilent	87405B	My39500554	2015.03.29	2016.03.28
Preamplifier	Agilent	8449B	3008A02342	2015.03.29	2016.03.28
Bilog Antenna	Sunol Science	JB1	A072414-1	2015.04.22	2016.04.21
Broad-Band Horn Antenna	Schwarzbeck	BBHA9120D	9120D-619	2015.04.20	2016.04.19
Spectrum Analyzer	R&S	FSP40	100324	2015.03.29	2016.03.28
Temperature/ Humidity Meter	Zhicheng	ZC1-11	CEP-TH-001	2015.04.02	2016.04.01
EZ-EMC	Fala	Ver CT3A1	N/A	N/A	N/A



### 5.5. Test Result and Data (30MHz ~ 1GHz)

First edition:

Test Mode :	Mode 1: Full system (VGA mode 1920*1080@60Hz)		
AC Power :	AC 230V/50Hz	Ant. Polarization:	Horizontal
Equipment :	LCD Monitor	Model No :	236LM00031
Temperature :	23°C	Humidity :	56%
Pressure(mbar) :	1001	Date:	2015/12/22

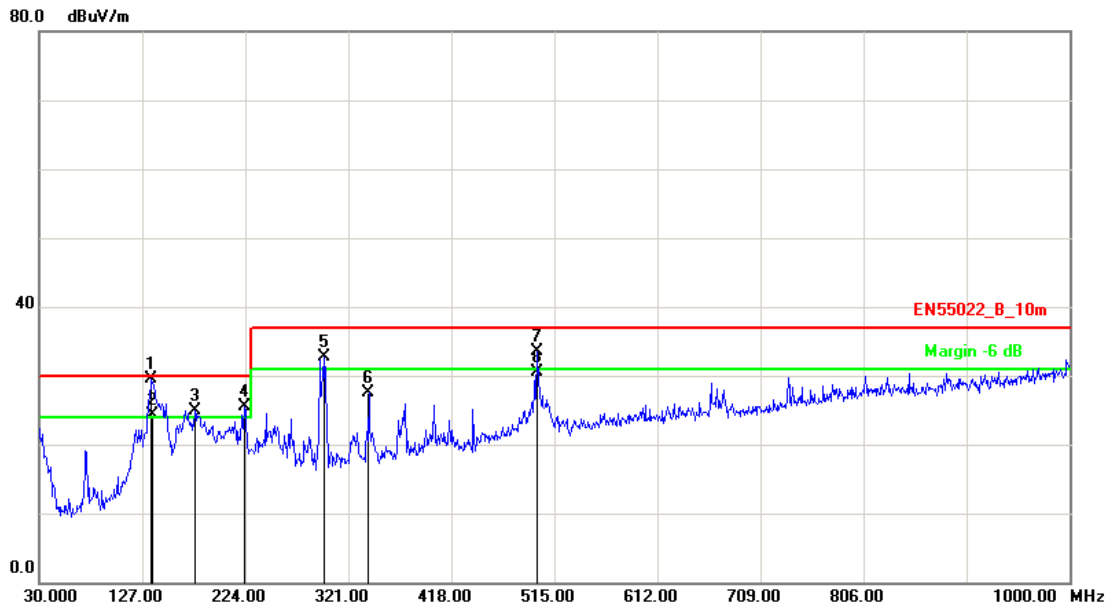

No.	Frequency (MHz)	Factor (dB/m)	Reading (dBuV)	Level (dBuV/m)	Limit (dBuV/m)	Margin (dB)	Det.	Height (cm)	Azimuth (deg)
1	135.7298	-10.23	39.69	29.46	30.00	-0.54	peak	400	191
2	136.8500	-10.28	34.64	24.36	30.00	-5.64	QP	400	191
3	176.4699	-11.37	36.35	24.98	30.00	-5.02	peak	400	162
4	223.0300	-11.77	37.19	25.42	30.00	-4.58	peak	400	166
5	298.6899	-8.76	41.50	32.74	37.00	-4.26	peak	400	134
6	340.3999	-7.78	35.29	27.51	37.00	-9.49	peak	100	156
7	498.5099	-3.06	36.47	33.41	37.00	-3.59	peak	100	25
8	498.7368	-3.05	33.63	30.58	37.00	-6.42	QP	100	25

Note: Measurement Level = Reading Level + Correct Factor





Test Mode :	Mode 1: Full system (VGA mode 1920*1080@60Hz)		
AC Power :	AC 230V/50Hz	Ant. Polarization:	Vertical
Equipment :	LCD Monitor	Model No :	236LM00031
Temperature :	23°C	Humidity :	56%
Pressure(mbar) :	1001	Date:	2015/12/22

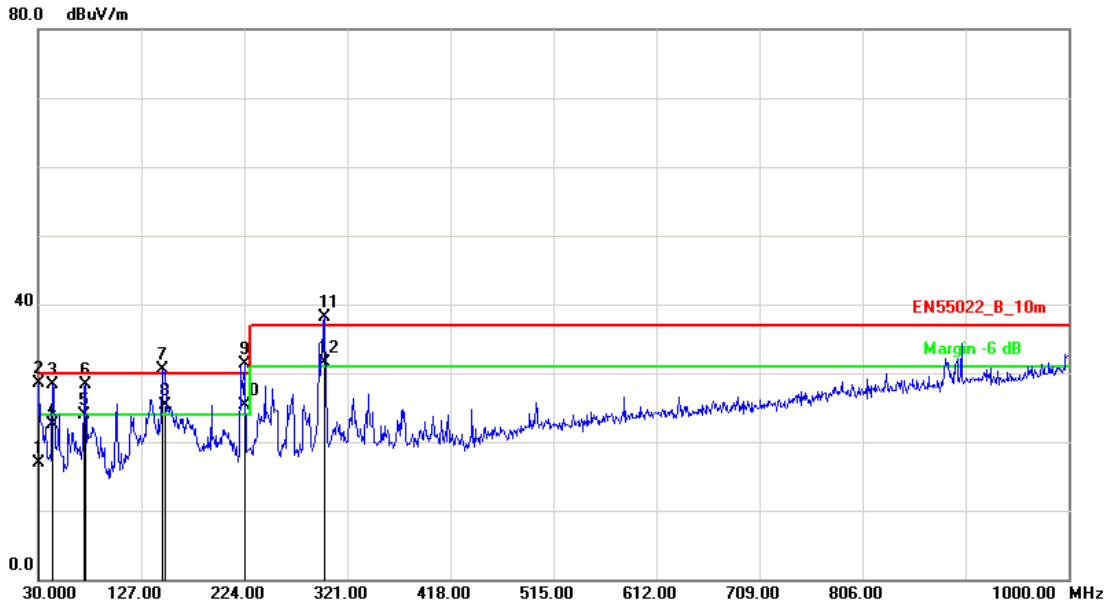

No.	Frequency (MHz)	Factor (dB/m)	Reading (dBuV)	Level (dBuV/m)	Limit (dBuV/m)	Margin (dB)	Det.	Height (cm)	Azimuth (deg)
1	30.1550	-3.37	20.27	16.90	30.00	-13.10	QP	100	98
2	30.9700	-3.96	32.46	28.50	30.00	-1.50	peak	100	98
3	43.5800	-12.54	40.90	28.36	30.00	-1.64	peak	100	247
4	44.2000	-12.90	35.40	22.50	30.00	-7.50	QP	100	249
5	73.6200	-15.91	39.81	23.90	30.00	-6.10	QP	100	145
6	74.6200	-15.96	44.26	28.30	30.00	-1.70	peak	100	145
7	147.3700	-10.58	41.07	30.49	30.00	0.49	peak	100	225
8	149.8300	-10.64	35.94	25.30	30.00	-4.70	QP	100	225
9	224.0000	-11.71	42.96	31.25	30.00	1.25	peak	100	161
10	224.8000	-11.67	36.97	25.30	30.00	-4.70	QP	100	161
11	299.6600	-8.76	46.96	38.20	37.00	1.20	peak	400	176
12	299.8630	-8.76	40.35	31.59	37.00	-5.41	QP	400	175

Note: Measurement Level = Reading Level + Correct Factor



Test Mode :	Mode 4: Full system (HDMI mode 1920*1080@60Hz)		
AC Power :	AC 230V/50Hz	Ant. Polarization:	Horizontal
Equipment :	LCD Monitor	Model No :	236LM00031
Temperature :	23°C	Humidity :	56%
Pressure(mbar) :	1001	Date:	2015/12/22

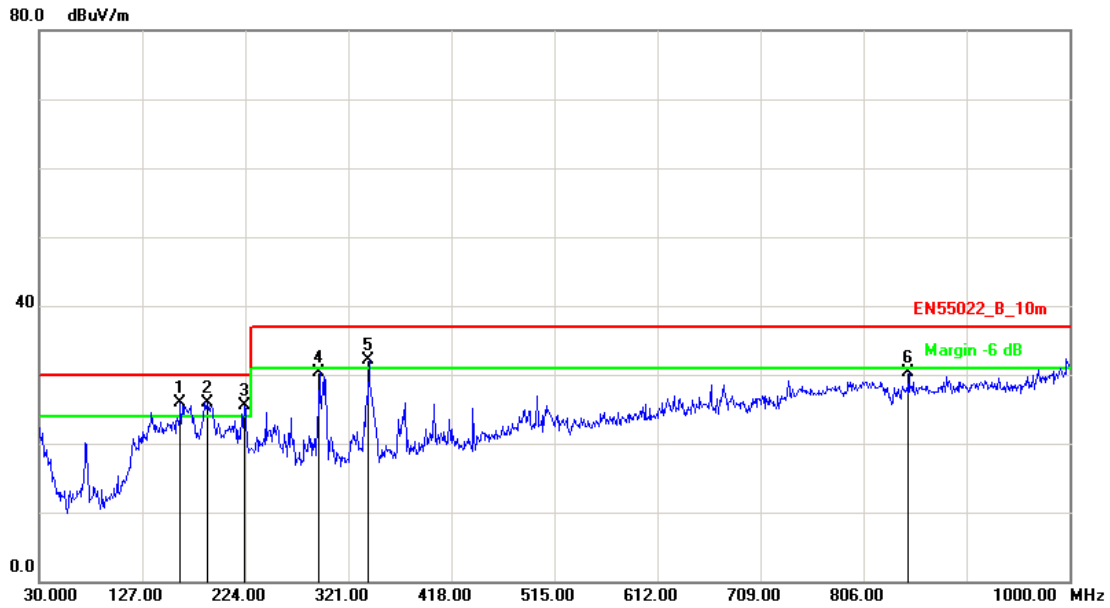

No.	Frequency (MHz)	Factor (dB/m)	Reading (dBuV)	Level (dBuV/m)	Limit (dBuV/m)	Margin (dB)	Det.	Height (cm)	Azimuth (deg)
1	162.8899	-10.95	36.86	25.91	30.00	-4.09	peak	100	264
2	188.1100	-10.85	36.85	26.00	30.00	-4.00	peak	400	59
3	223.0300	-11.77	37.19	25.42	30.00	-4.58	peak	100	245
4	293.8399	-8.78	39.15	30.37	37.00	-6.63	peak	100	124
5	340.3999	-7.78	39.79	32.01	37.00	-4.99	peak	100	8
6	848.6799	2.54	27.78	30.32	37.00	-6.68	peak	400	350

Note: Measurement Level = Reading Level + Correct Factor



Test Mode :	Mode 4: Full system (HDMI mode 1920*1080@60Hz)		
AC Power :	AC 230V/50Hz	Ant. Polarization:	Vertical
Equipment :	LCD Monitor	Model No :	236LM00031
Temperature :	23°C	Humidity :	56%
Pressure(mbar) :	1001	Date:	2015/12/22

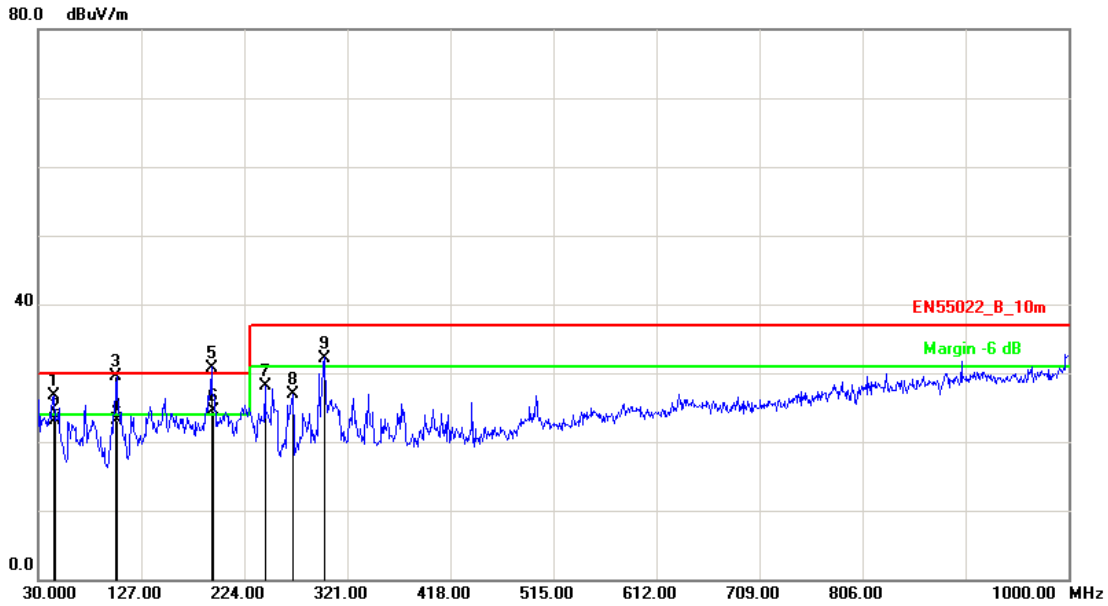

No.	Frequency (MHz)	Factor (dB/m)	Reading (dBuV)	Level (dBuV/m)	Limit (dBuV/m)	Margin (dB)	Det.	Height (cm)	Azimuth (deg)
1	44.5499	-13.10	39.76	26.66	30.00	-3.34	peak	100	320
2	45.9900	-13.92	37.10	23.18	30.00	-6.82	QP	100	322
3	103.7199	-13.01	42.43	29.42	30.00	-0.58	peak	100	59
4	104.8900	-12.76	35.96	23.20	30.00	-6.80	QP	100	66
5	192.9600	-10.47	41.27	30.80	30.00	0.80	peak	100	247
6	194.8700	-10.32	34.87	24.55	30.00	-5.45	QP	100	250
7	243.4000	-10.71	38.72	28.01	37.00	-8.99	peak	400	114
8	269.5899	-9.46	36.39	26.93	37.00	-10.07	peak	400	255
9	299.6600	-8.76	40.96	32.20	37.00	-4.80	peak	100	9

Note: Measurement Level = Reading Level + Correct Factor



Test Mode :	Mode 7: Full system (DVI mode 1920*1080@60Hz)		
AC Power :	AC 230V/50Hz	Ant. Polarization:	Horizontal
Equipment :	LCD Monitor	Model No :	236LM00031
Temperature :	23°C	Humidity :	56%
Pressure(mbar) :	1001	Date:	2015/12/22

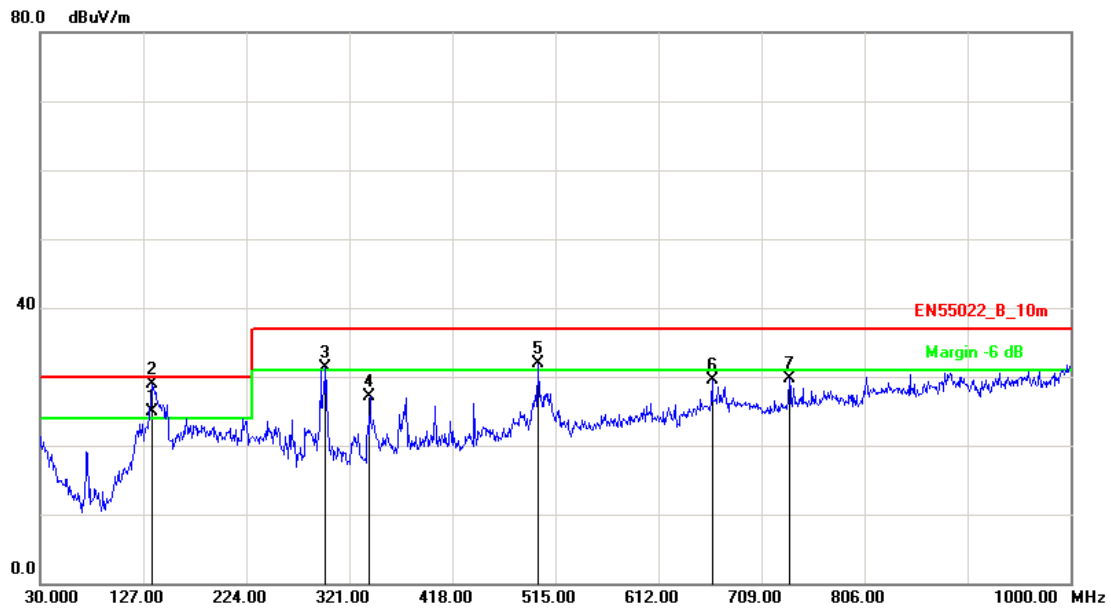

No.	Frequency (MHz)	Factor (dB/m)	Reading (dBuV)	Level (dBuV/m)	Limit (dBuV/m)	Margin (dB)	Det.	Height (cm)	Azimuth (deg)
1	134.8000	-10.19	35.08	24.89	30.00	-5.11	QP	100	240
2	135.7299	-10.23	39.19	28.96	30.00	-1.04	peak	100	245
3	298.6899	-8.76	40.00	31.24	37.00	-5.76	peak	100	148
4	340.3999	-7.78	34.79	27.01	37.00	-9.99	peak	400	360
5	498.5099	-3.06	34.97	31.91	37.00	-5.09	peak	400	5
6	662.4400	-0.10	29.58	29.48	37.00	-7.52	peak	100	89
7	735.1900	0.73	28.88	29.61	37.00	-7.39	peak	100	244

Note: Measurement Level = Reading Level + Correct Factor



Test Mode :	Mode 7: Full system (DVI mode 1920*1080@60Hz)		
AC Power :	AC 230V/50Hz	Ant. Polarization:	Vertical
Equipment :	LCD Monitor	Model No :	236LM00031
Temperature :	23°C	Humidity :	56%
Pressure(mbar) :	1001	Date:	2015/12/22

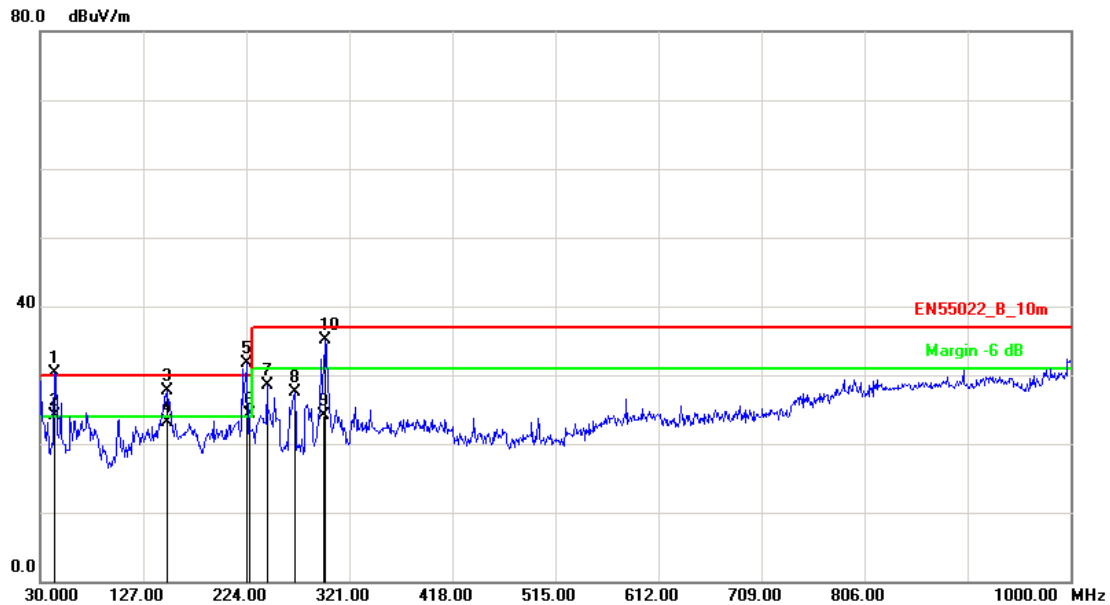

No.	Frequency (MHz)	Factor (dB/m)	Reading (dBuV)	Level (dBuV/m)	Limit (dBuV/m)	Margin (dB)	Det.	Height (cm)	Azimuth (deg)
1	43.5799	-12.54	42.90	30.36	30.00	0.36	peak	100	59
2	44.2100	-12.90	36.95	24.05	30.00	-5.95	QP	100	61
3	149.3100	-10.62	38.40	27.78	30.00	-2.22	peak	100	248
4	150.2700	-10.65	33.80	23.15	30.00	-6.85	QP	100	245
5	224.0000	-11.71	43.46	31.75	30.00	1.75	peak	400	127
6	226.8700	-11.56	35.92	24.36	30.00	-5.64	QP	400	120
7	243.4000	-10.71	39.22	28.51	37.00	-8.49	peak	100	330
8	269.5899	-9.46	36.89	27.43	37.00	-9.57	peak	100	358
9	297.4400	-8.77	32.78	24.01	37.00	-12.99	QP	400	33
10	298.6899	-8.76	43.82	35.06	37.00	-1.94	peak	400	29

Note: Measurement Level = Reading Level + Correct Factor



Original:

Test Mode :	Mode 1: Full system (VGA mode 1920*1080@60Hz) for Horizontal		
AC Power :	AC 230V/50Hz	Ant. Polarization:	Horizontal
Equipment :	LCD Monitor	Model No :	236LM00031
Temperature :	22°C	Humidity :	56%
Pressure(mbar) :	1001	Date:	2015/12/16

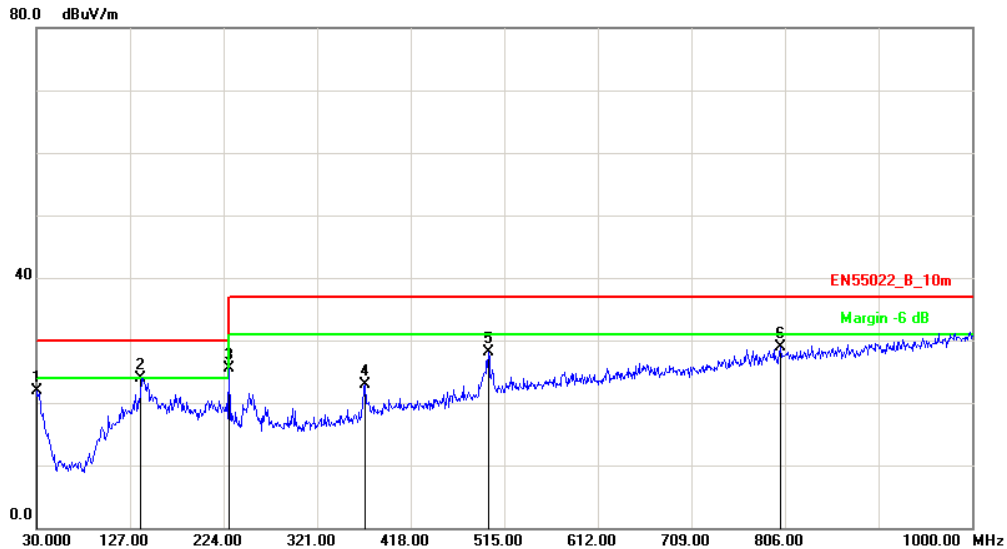

No.	Frequency (MHz)	Factor (dB/m)	Reading (dBuV)	Level (dBuV/m)	Limit (dBuV/m)	Margin (dB)	Det.	Height (cm)	Azimuth (deg)
1	30.0000	-3.26	25.20	21.94	30.00	-8.06	peak	400	70
2	138.6399	-10.36	34.24	23.88	30.00	-6.12	peak	400	91
3	229.8199	-11.40	36.98	25.58	30.00	-4.42	peak	400	250
4	370.4700	-6.58	29.58	23.00	37.00	-14.00	peak	100	231
5	498.5099	-3.06	31.12	28.06	37.00	-8.94	peak	100	34
6	801.1499	2.08	26.74	28.82	37.00	-8.18	peak	400	224

Note: Measurement Level = Reading Level + Correct Factor



Test Mode :	Mode 1: Full system (VGA mode 1920*1080@60Hz) for Horizontal		
AC Power :	AC 230V/50Hz	Ant. Polarization:	Vertical
Equipment :	LCD Monitor	Model No :	236LM00031
Temperature :	22°C	Humidity :	56%
Pressure(mbar) :	1001	Date:	2015/12/16

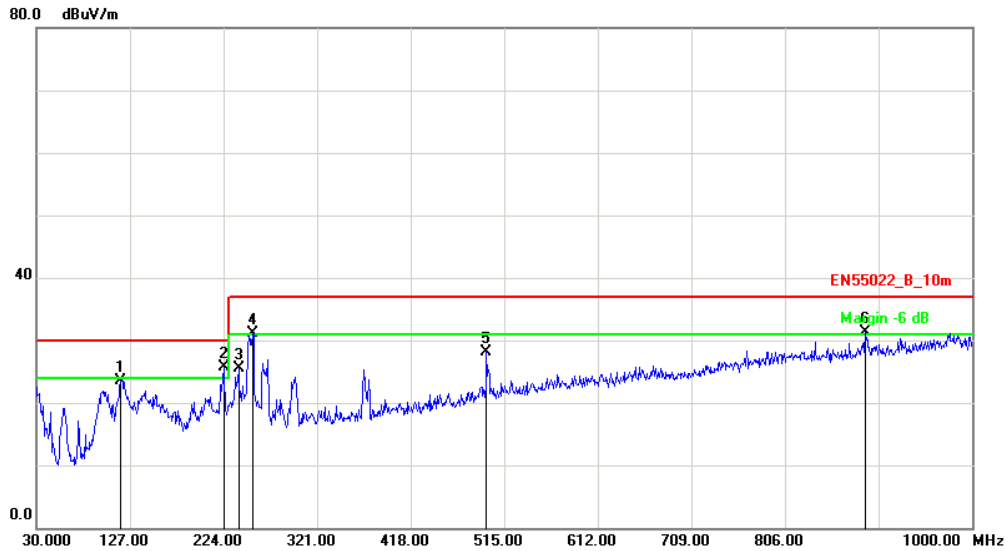

No.	Frequency (MHz)	Factor (dB/m)	Reading (dBuV)	Level (dBuV/m)	Limit (dBuV/m)	Margin (dB)	Det.	Height (cm)	Azimuth (deg)
1	117.3000	-10.12	33.67	23.55	30.00	-6.45	peak	100	288
2	224.0000	-11.71	37.43	25.72	30.00	-4.28	peak	100	216
3	239.5200	-10.88	36.42	25.54	37.00	-11.46	peak	400	221
4	254.0700	-10.28	41.40	31.12	37.00	-5.88	peak	100	336
5	496.5700	-3.12	31.17	28.05	37.00	-8.95	peak	400	42
6	889.4200	3.27	27.94	31.21	37.00	-5.79	peak	100	289

Note: Measurement Level = Reading Level + Correct Factor



Test Mode :	Mode 4: Full system (DVI mode 1920*1080@60Hz) for Horizontal		
AC Power :	AC 230V/50Hz	Ant. Polarization:	Horizontal
Equipment :	LCD Monitor	Model No :	236LM00031
Temperature :	22°C	Humidity :	56%
Pressure(mbar) :	1001	Date:	2015/12/16

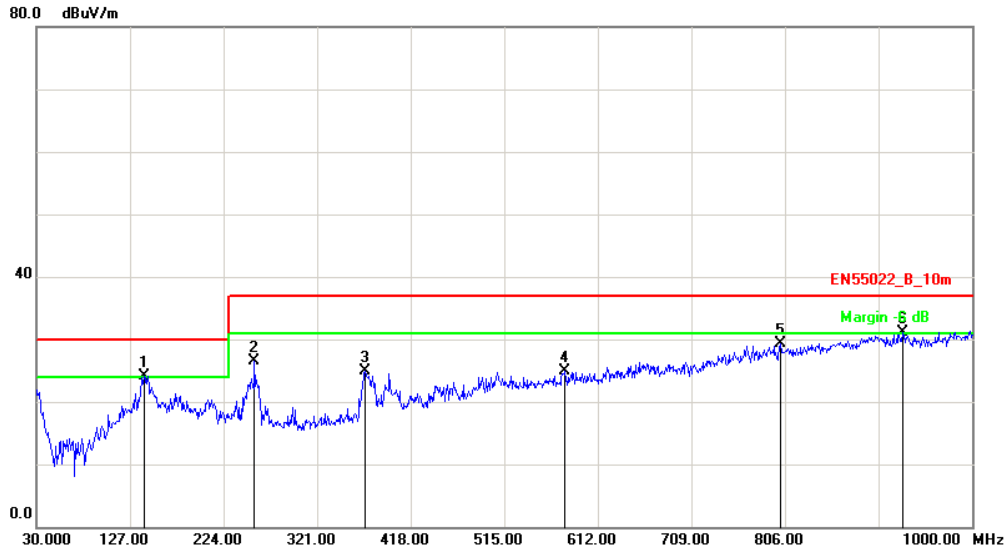

No.	Frequency (MHz)	Factor (dB/m)	Reading (dBuV)	Level (dBuV/m)	Limit (dBuV/m)	Margin (dB)	Det.	Height (cm)	Azimuth (deg)
1	141.5500	-10.45	34.51	24.06	30.00	-5.94	peak	400	141
2	256.0099	-10.20	36.68	26.48	37.00	-10.52	peak	400	336
3	370.4700	-6.58	31.58	25.00	37.00	-12.00	peak	100	231
4	578.0498	-1.55	26.45	24.90	37.00	-12.10	peak	400	327
5	801.1499	2.08	27.24	29.32	37.00	-7.68	peak	400	224
6	928.2200	3.79	27.22	31.01	37.00	-5.99	peak	400	228

Note: Measurement Level = Reading Level + Correct Factor





Test Mode :	Mode 4: Full system (DVI mode 1920*1080@60Hz) for Horizontal		
AC Power :	AC 230V/50Hz	Ant. Polarization:	Vertical
Equipment :	LCD Monitor	Model No :	236LM00031
Temperature :	22°C	Humidity :	56%
Pressure(mbar) :	1001	Date:	2015/12/16

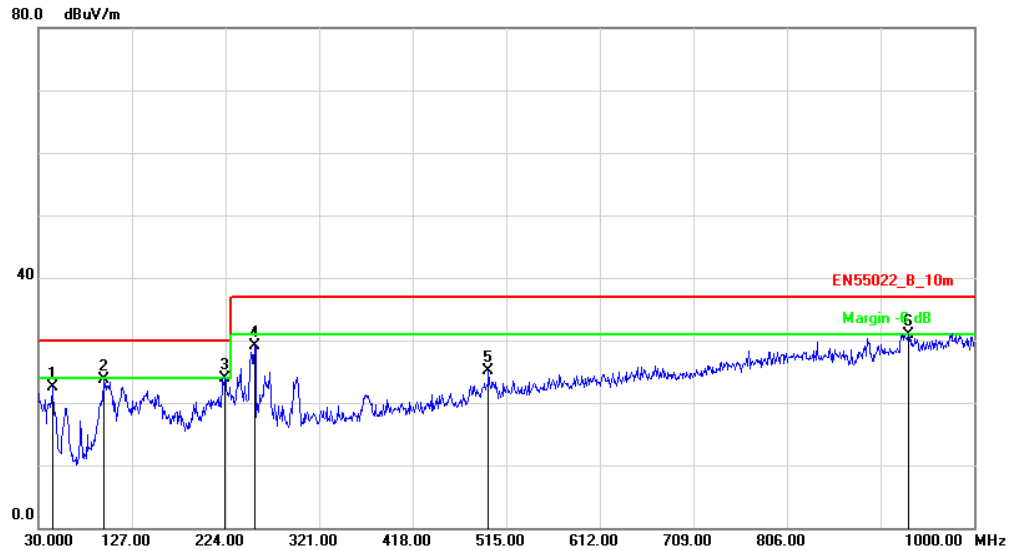

No.	Frequency (MHz)	Factor (dB/m)	Reading (dBuV)	Level (dBuV/m)	Limit (dBuV/m)	Margin (dB)	Det.	Height (cm)	Azimuth (deg)
1	44.5499	-13.10	35.52	22.42	30.00	-7.58	peak	100	78
2	97.9000	-14.33	38.05	23.72	30.00	-6.28	peak	100	59
3	223.0300	-11.77	35.68	23.91	30.00	-6.09	peak	400	187
4	254.0699	-10.28	39.40	29.12	37.00	-7.88	peak	400	198
5	496.5699	-3.12	28.17	25.05	37.00	-11.95	peak	100	354
6	932.1000	3.83	27.02	30.85	37.00	-6.15	peak	100	200

Note: Measurement Level = Reading Level + Correct Factor



Test Mode :	Mode 9: Full system (HDMI mode 1920*1080@60Hz) for Horizontal		
AC Power :	AC 230V/50Hz	Ant. Polarization:	Horizontal
Equipment :	LCD Monitor	Model No :	236LM00031
Temperature :	22°C	Humidity :	56%
Pressure(mbar) :	1001	Date:	2015/12/16

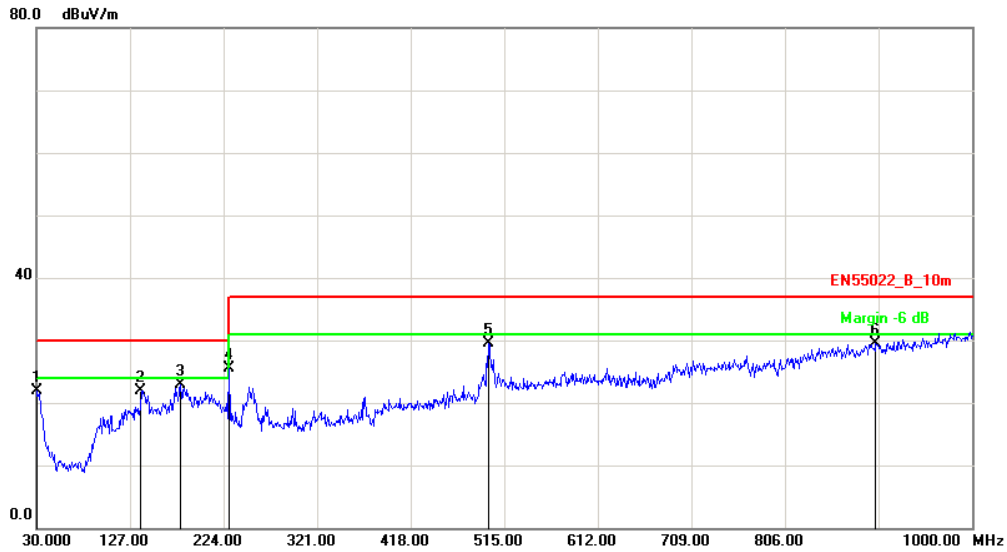

No.	Frequency (MHz)	Factor (dB/m)	Reading (dBuV)	Level (dBuV/m)	Limit (dBuV/m)	Margin (dB)	Det.	Height (cm)	Azimuth (deg)
1	30.0000	-3.26	25.20	21.94	30.00	-8.06	peak	100	100
2	138.6399	-10.36	32.24	21.88	30.00	-8.12	peak	400	127
3	179.3799	-11.46	34.40	22.94	30.00	-7.06	peak	200	359
4	229.8199	-11.40	36.97	25.57	30.00	-4.43	peak	400	58
5	498.5099	-3.06	32.62	29.56	37.00	-7.44	peak	100	274
6	900.0900	3.51	26.08	29.59	37.00	-7.41	peak	100	300

Note: Measurement Level = Reading Level + Correct Factor



Test Mode :	Mode 9: Full system (HDMI mode 1920*1080@60Hz) for Horizontal		
AC Power :	AC 230V/50Hz	Ant. Polarization:	Vertical
Equipment :	LCD Monitor	Model No :	236LM00031
Temperature :	22°C	Humidity :	56%
Pressure(mbar) :	1001	Date:	2015/12/16

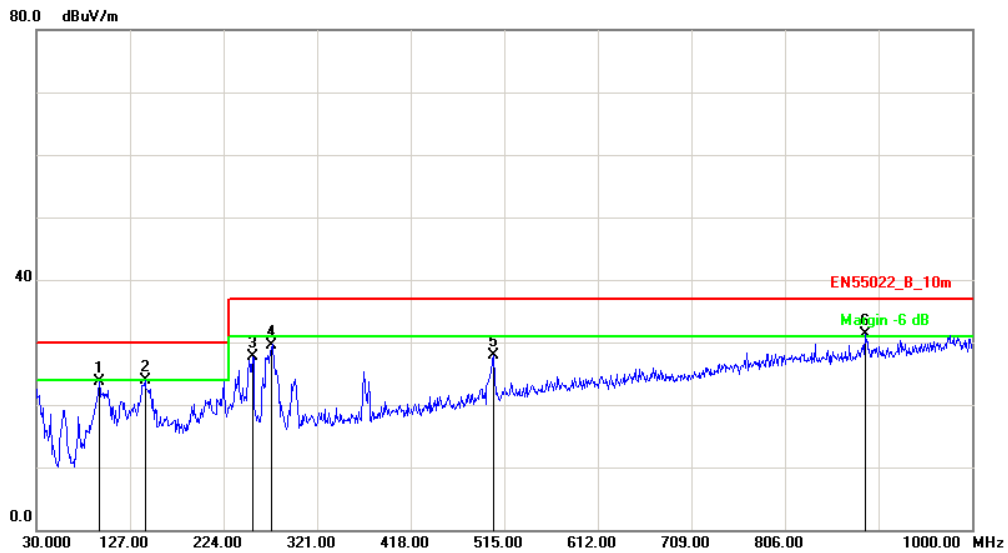

No.	Frequency (MHz)	Factor (dB/m)	Reading (dBuV)	Level (dBuV/m)	Limit (dBuV/m)	Margin (dB)	Det.	Height (cm)	Azimuth (deg)
1	94.9899	-15.06	38.69	23.63	30.00	-6.37	peak	400	35
2	142.5200	-10.48	34.43	23.95	30.00	-6.05	peak	100	254
3	254.0699	-10.28	37.90	27.62	37.00	-9.38	peak	100	358
4	274.4399	-9.17	38.77	29.60	37.00	-7.40	peak	300	120
5	503.3600	-2.94	30.83	27.89	37.00	-9.11	peak	100	100
6	889.4199	3.27	27.94	31.21	37.00	-5.79	peak	100	198

Note: Measurement Level = Reading Level + Correct Factor



### 5.6. Test Result and Data (1GHz ~ 6GHz)

First edition:

Test Mode :	Mode 1: Full system (VGA mode 1920*1080@60Hz)		
AC Power :	AC 230V/50Hz	Ant. Polarization:	Horizontal
Equipment :	LCD Monitor	Model No :	236LM00031
Temperature :	23°C	Humidity :	56%
Pressure(mbar) :	1001	Date:	2015/12/22

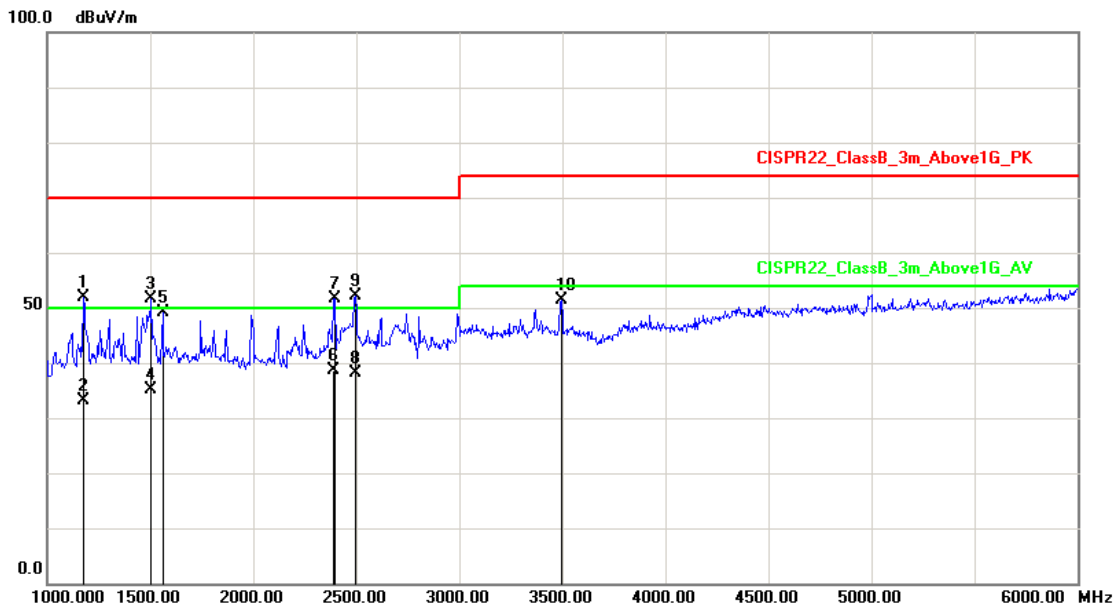

No.	Frequency (MHz)	Factor (dB/m)	Reading (dBuV)	Level (dBuV/m)	Limit (dBuV/m)	Margin (dB)	Det.	Height (cm)	Azimuth (deg)
1	1175.000	-4.81	56.81	52.00	70.00	-18.00	peak	100	56
2	1176.350	-4.80	38.01	33.21	50.00	-16.79	AVG	100	55
3	1505.000	-2.63	54.23	51.60	70.00	-18.40	peak	100	127
4	1506.310	-2.62	37.64	35.02	50.00	-14.98	AVG	100	120
5	1560.000	-2.47	51.53	49.06	70.00	-20.94	peak	400	256
6	2392.760	0.80	37.90	38.70	50.00	-11.30	AVG	100	80
7	2395.000	0.81	50.76	51.57	70.00	-18.43	peak	100	89
8	2494.860	1.32	36.79	38.11	50.00	-11.89	AVG	100	350
9	2495.000	1.32	50.74	52.06	70.00	-17.94	peak	100	358
10	3495.000	5.64	45.82	51.46	74.00	-22.54	peak	100	159

Note: Measurement Level = Reading Level + Correct Factor



Test Mode :	Mode 1: Full system (VGA mode 1920*1080@60Hz)		
AC Power :	AC 230V/50Hz	Ant. Polarization:	Vertical
Equipment :	LCD Monitor	Model No :	236LM00031
Temperature :	23°C	Humidity :	56%
Pressure(mbar) :	1001	Date:	2015/12/22

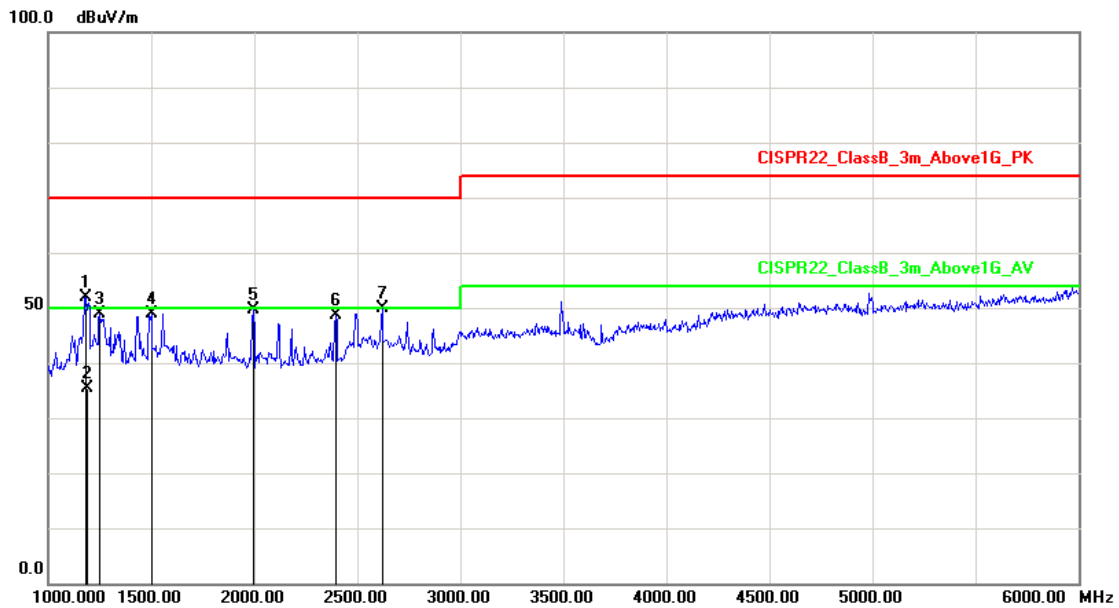

No.	Frequency (MHz)	Factor (dB/m)	Reading (dBuV)	Level (dBuV/m)	Limit (dBuV/m)	Margin (dB)	Det.	Height (cm)	Azimuth (deg)
1	1185.000	-4.74	56.71	51.97	70.00	-18.03	peak	100	259
2	1187.320	-4.73	40.23	35.50	50.00	-14.50	AVG	100	181
3	1250.000	-4.31	53.28	48.97	70.00	-21.03	peak	100	277
4	1500.000	-2.64	51.58	48.94	70.00	-21.06	peak	100	347
5	1995.000	-1.21	50.78	49.57	70.00	-20.43	peak	100	89
6	2395.000	0.81	47.71	48.52	70.00	-21.48	peak	400	124
7	2620.000	2.01	47.87	49.88	70.00	-20.12	peak	400	6

Note: Measurement Level = Reading Level + Correct Factor



Test Mode :	Mode 4: Full system (HDMI mode 1920*1080@60Hz)		
AC Power :	AC 230V/50Hz	Ant. Polarization:	Horizontal
Equipment :	LCD Monitor	Model No :	236LM00031
Temperature :	23°C	Humidity :	56%
Pressure(mbar) :	1001	Date:	2015/12/22

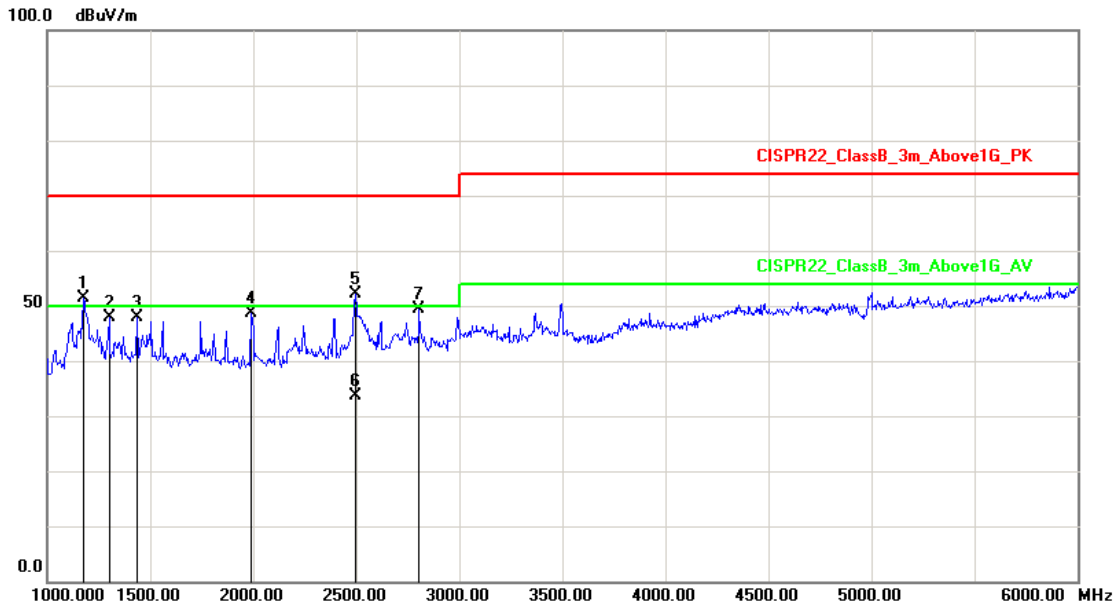

No.	Frequency (MHz)	Factor (dB/m)	Reading (dBuV)	Level (dBuV/m)	Limit (dBuV/m)	Margin (dB)	Det.	Height (cm)	Azimuth (deg)
1	1175.000	-4.81	56.31	51.50	70.00	-18.50	peak	100	247
2	1300.000	-3.98	51.79	47.81	70.00	-22.19	peak	400	165
3	1435.000	-3.07	50.89	47.82	70.00	-22.18	peak	400	268
4	1990.000	-1.23	49.79	48.56	70.00	-21.44	peak	400	324
5	2495.000	1.32	50.74	52.06	70.00	-17.94	peak	100	90
6	2496.320	1.33	32.23	33.56	50.00	-16.44	AVG	100	89
7	2805.000	3.04	46.46	49.50	70.00	-20.50	peak	100	55

Note: Measurement Level = Reading Level + Correct Factor



Test Mode :	Mode 4: Full system (HDMI mode 1920*1080@60Hz)		
AC Power :	AC 230V/50Hz	Ant. Polarization:	Vertical
Equipment :	LCD Monitor	Model No :	236LM00031
Temperature :	23°C	Humidity :	56%
Pressure(mbar) :	1001	Date:	2015/12/22

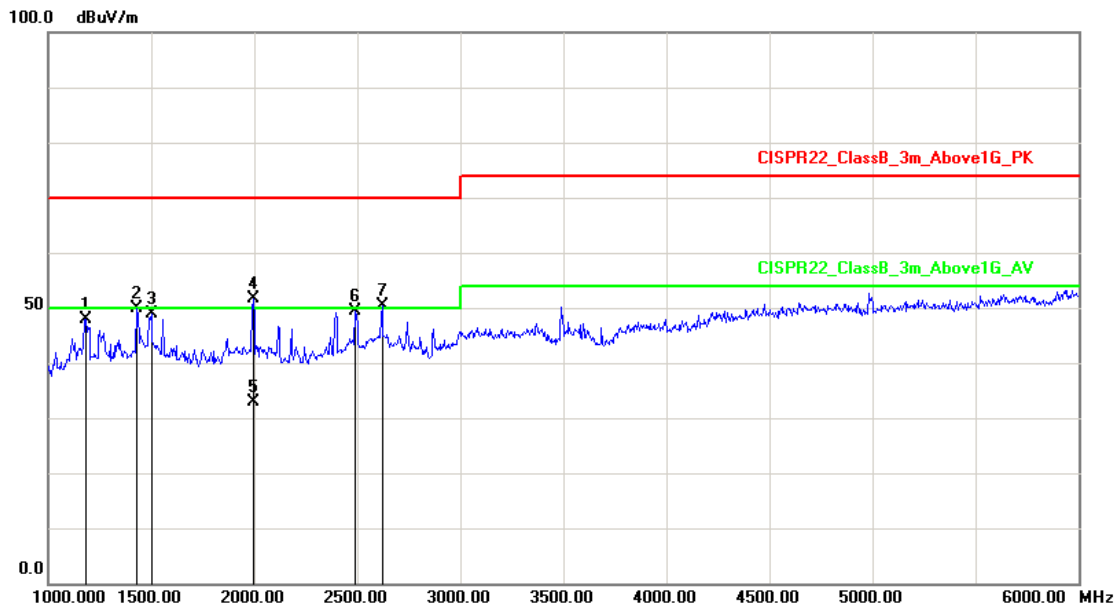

No.	Frequency (MHz)	Factor (dB/m)	Reading (dBuV)	Level (dBuV/m)	Limit (dBuV/m)	Margin (dB)	Det.	Height (cm)	Azimuth (deg)
1	1185.000	-4.74	52.71	47.97	70.00	-22.03	peak	100	254
2	1430.000	-3.11	52.91	49.80	70.00	-20.20	peak	100	360
3	1500.000	-2.64	51.58	48.94	70.00	-21.06	peak	400	8
4	1995.000	-1.21	52.78	51.57	70.00	-18.43	peak	100	124
5	1996.870	-1.21	34.10	32.89	50.00	-17.11	AVG	100	120
6	2490.000	1.30	48.05	49.35	70.00	-20.65	peak	400	9
7	2620.000	2.01	48.37	50.38	70.00	-19.62	peak	100	157

Note: Measurement Level = Reading Level + Correct Factor



Test Mode :	Mode 7: Full system (DVI mode 1920*1080@60Hz)		
AC Power :	AC 230V/50Hz	Ant. Polarization:	Horizontal
Equipment :	LCD Monitor	Model No :	236LM00031
Temperature :	23°C	Humidity :	56%
Pressure(mbar) :	1001	Date:	2015/12/22

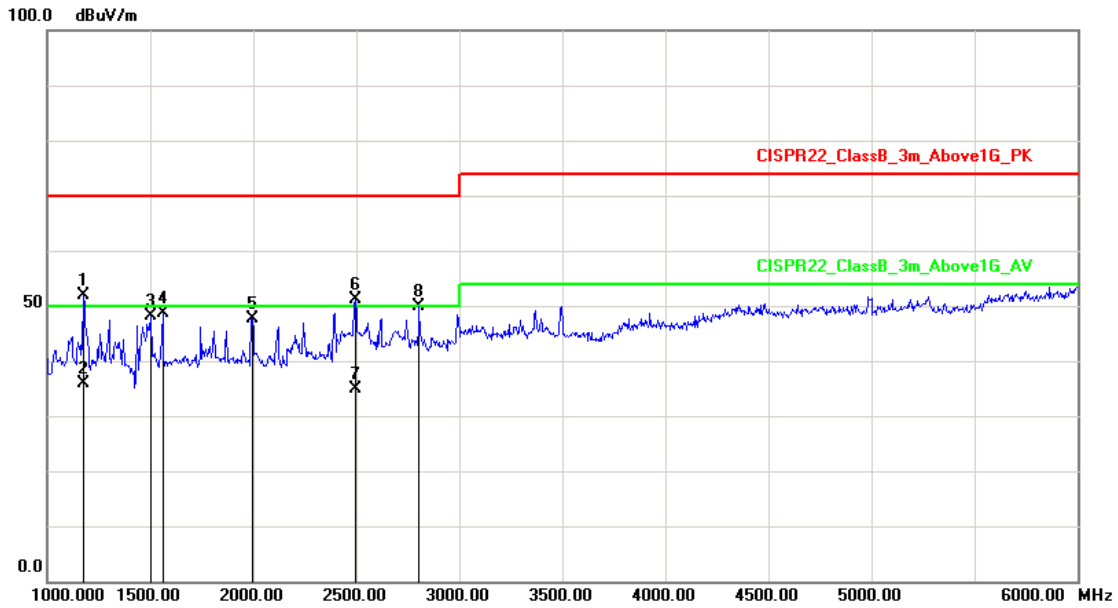

No.	Frequency (MHz)	Factor (dB/m)	Reading (dBuV)	Level (dBuV/m)	Limit (dBuV/m)	Margin (dB)	Det.	Height (cm)	Azimuth (deg)
1	1175.000	-4.81	56.81	52.00	70.00	-18.00	peak	100	247
2	1176.370	-4.80	40.69	35.89	50.00	-14.11	AVG	100	240
3	1505.000	-2.63	50.73	48.10	70.00	-21.90	peak	400	226
4	1560.000	-2.47	51.03	48.56	70.00	-21.44	peak	100	124
5	1995.000	-1.21	48.94	47.73	70.00	-22.27	peak	100	36
6	2495.000	1.32	49.74	51.06	70.00	-18.94	peak	100	148
7	2496.250	1.33	33.48	34.81	50.00	-15.19	AVG	100	119
8	2805.000	3.04	46.96	50.00	70.00	-20.00	peak	400	347

Note: Measurement Level = Reading Level + Correct Factor





Test Mode :	Mode 7: Full system (DVI mode 1920*1080@60Hz)		
AC Power :	AC 230V/50Hz	Ant. Polarization:	Vertical
Equipment :	LCD Monitor	Model No :	236LM00031
Temperature :	23°C	Humidity :	56%
Pressure(mbar) :	1001	Date:	2015/12/22

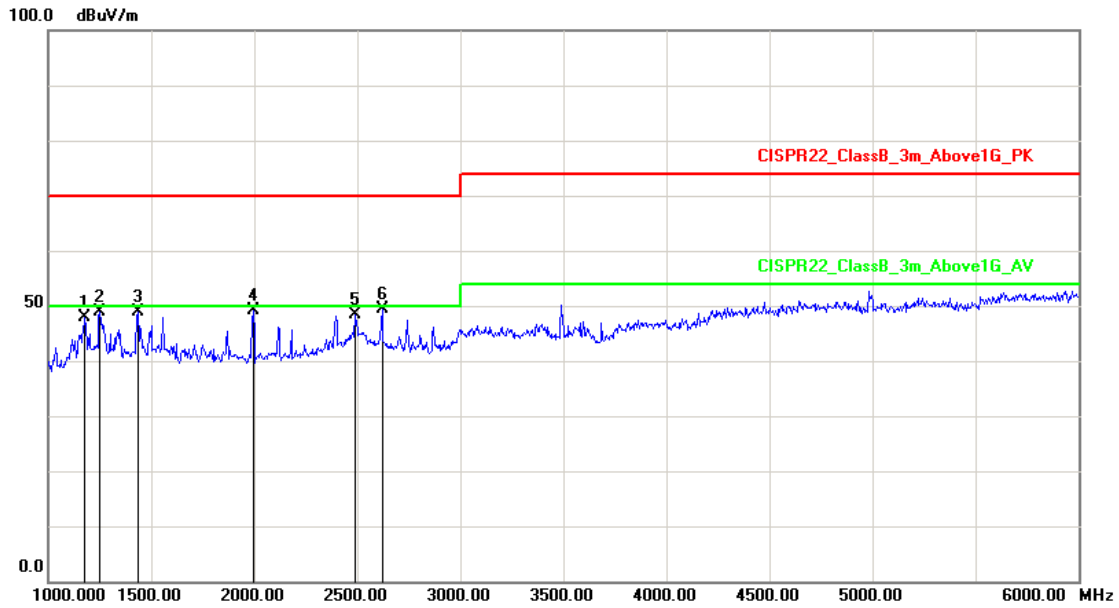

No.	Frequency (MHz)	Factor (dB/m)	Reading (dBuV)	Level (dBuV/m)	Limit (dBuV/m)	Margin (dB)	Det.	Height (cm)	Azimuth (deg)
1	1175.000	-4.81	52.61	47.80	70.00	-22.20	peak	100	68
2	1250.000	-4.31	53.28	48.97	70.00	-21.03	peak	100	256
3	1435.000	-3.07	51.90	48.83	70.00	-21.17	peak	400	310
4	1995.000	-1.21	50.28	49.07	70.00	-20.93	peak	100	5
5	2490.000	1.30	47.05	48.35	70.00	-21.65	peak	100	301
6	2620.000	2.01	47.37	49.38	70.00	-20.62	peak	400	129

Note: Measurement Level = Reading Level + Correct Factor



Original:

Test Mode :	Mode 1: Full system (VGA mode 1920*1080@60Hz) for Horizontal		
AC Power :	AC 230V/50Hz	Ant. Polarization:	Horizontal
Equipment :	LCD Monitor	Model No :	236LM00031
Temperature :	22°C	Humidity :	56%
Pressure(mbar) :	1001	Date:	2015/12/16

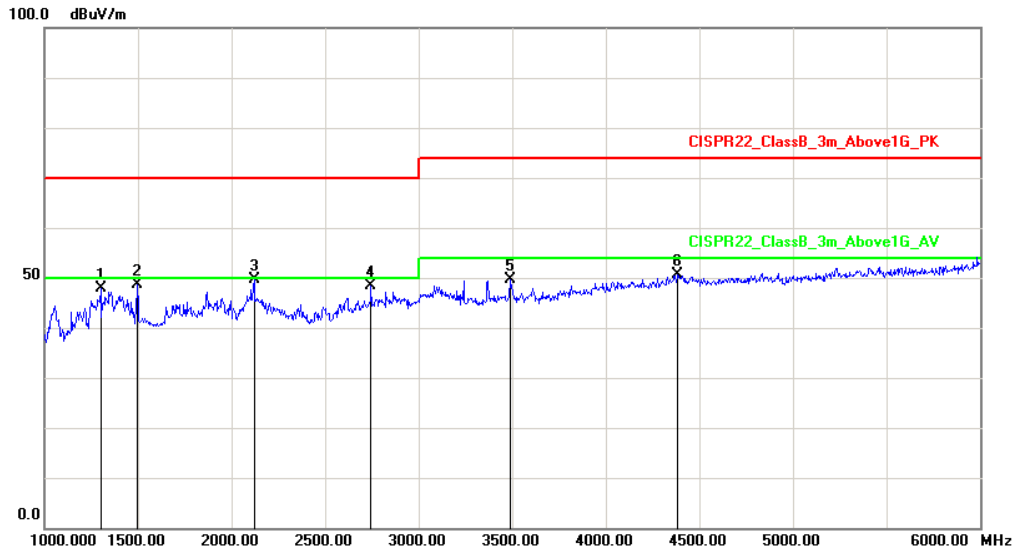

No.	Frequency (MHz)	Factor (dB/m)	Reading (dBuV)	Level (dBuV/m)	Limit (dBuV/m)	Margin (dB)	Det.	Height (cm)	Azimuth (deg)
1	1300.000	-3.98	51.89	47.91	70.00	-22.09	peak	100	124
2	1495.000	-2.67	51.37	48.70	70.00	-21.30	peak	100	269
3	2120.000	4.82	44.70	49.52	70.00	-20.48	peak	100	2
4	2745.000	2.71	45.75	48.46	70.00	-21.54	peak	100	189
5	3490.000	5.63	44.00	49.63	74.00	-24.37	peak	100	89
6	4385.000	9.46	41.20	50.66	74.00	-23.34	peak	100	358

Note: Measurement Level = Reading Level + Correct Factor



Test Mode :	Mode 1: Full system (VGA mode 1920*1080@60Hz) for Horizontal		
AC Power :	AC 230V/50Hz	Ant. Polarization:	Vertical
Equipment :	LCD Monitor	Model No :	236LM00031
Temperature :	22°C	Humidity :	56%
Pressure(mbar) :	1001	Date:	2015/12/16

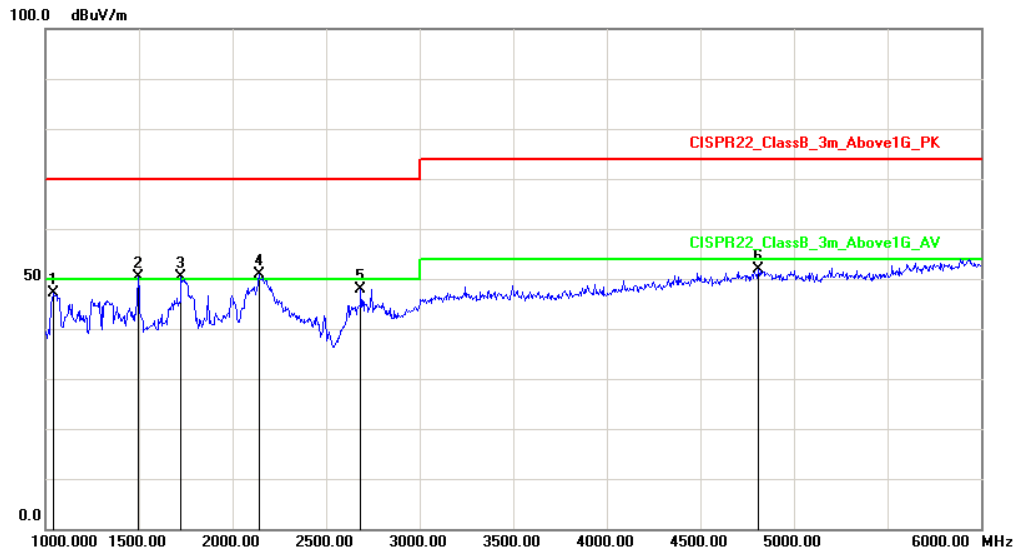

No.	Frequency (MHz)	Factor (dB/m)	Reading (dBuV)	Level (dBuV/m)	Limit (dBuV/m)	Margin (dB)	Det.	Height (cm)	Azimuth (deg)
1	1040.000	-5.71	52.77	47.06	70.00	-22.94	peak	100	59
2	1495.000	-2.67	53.00	50.33	70.00	-20.09	peak	100	124
3	1725.000	1.21	49.19	50.40	70.00	-20.04	peak	100	278
4	2140.000	4.64	46.24	50.88	70.00	-20.01	peak	100	3
5	2685.000	2.37	45.63	48.00	70.00	-22.00	peak	100	350
6	4810.000	10.73	41.26	51.99	74.00	-22.01	peak	100	175

Note: Measurement Level = Reading Level + Correct Factor



Test Mode :	Mode 5: Full system (DVI mode 1920*1080@60Hz) for Horizontal		
AC Power :	AC 230V/50Hz	Ant. Polarization:	Horizontal
Equipment :	LCD Monitor	Model No :	236LM00031
Temperature :	22°C	Humidity :	56%
Pressure(mbar) :	1001	Date:	2015/12/16

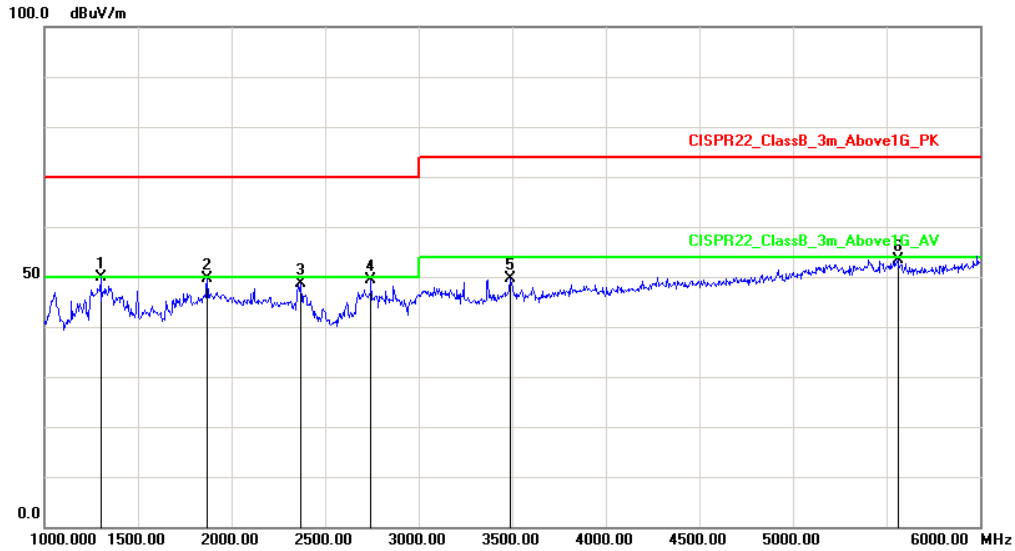

No.	Frequency (MHz)	Factor (dB/m)	Reading (dBuV)	Level (dBuV/m)	Limit (dBuV/m)	Margin (dB)	Det.	Height (cm)	Azimuth (deg)
1	1300.000	-3.98	53.89	49.91	70.00	-20.09	peak	100	346
2	1870.000	3.69	45.83	49.52	70.00	-20.48	peak	100	215
3	2370.000	2.54	46.09	48.63	70.00	-21.37	peak	100	345
4	2745.000	2.71	46.75	49.46	70.00	-20.54	peak	100	12
5	3490.000	5.63	44.00	49.63	74.00	-24.37	peak	100	179
6	5560.000	12.41	40.87	53.28	74.00	-20.72	peak	100	89

Note: Measurement Level = Reading Level + Correct Factor



Test Mode :	Mode 5: Full system (DVI mode 1920*1080@60Hz) for Horizontal		
AC Power :	AC 230V/50Hz	Ant. Polarization:	Vertical
Equipment :	LCD Monitor	Model No :	236LM00031
Temperature :	22°C	Humidity :	56%
Pressure(mbar) :	1001	Date:	2015/12/16

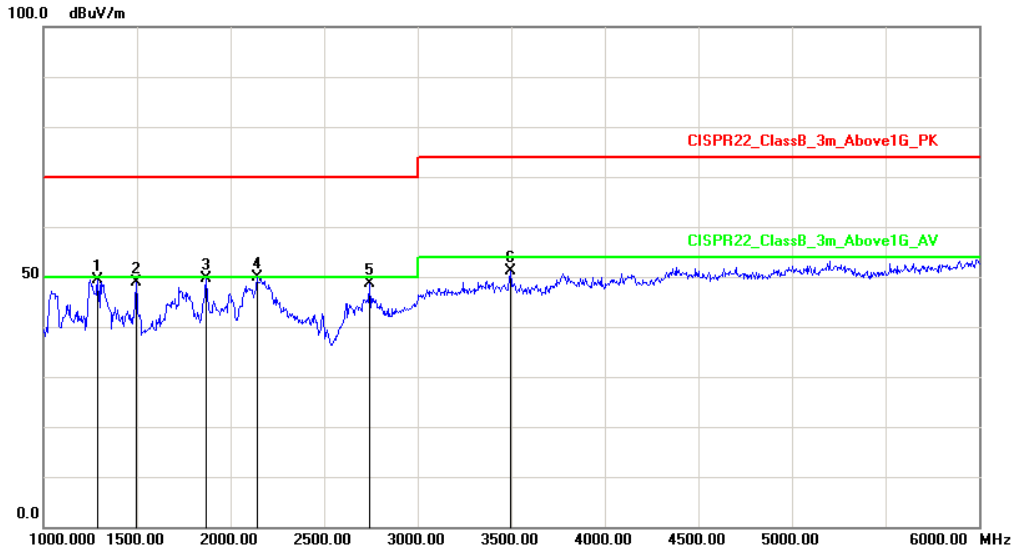

No.	Frequency (MHz)	Factor (dB/m)	Reading (dBuV)	Level (dBuV/m)	Limit (dBuV/m)	Margin (dB)	Det.	Height (cm)	Azimuth (deg)
1	1290.000	-4.04	53.50	49.46	70.00	-20.54	peak	100	128
2	1495.000	-2.67	51.50	48.83	70.00	-21.17	peak	100	310
3	1870.000	3.69	45.94	49.63	70.00	-20.37	peak	100	256
4	2140.000	4.64	45.24	49.88	70.00	-20.12	peak	100	89
5	2745.000	2.71	45.88	48.59	70.00	-21.41	peak	100	12
6	3495.000	5.64	45.47	51.11	74.00	-22.89	peak	100	276

Note: Measurement Level = Reading Level + Correct Factor



Test Mode :	Mode 9: Full system (HDMI mode 1920*1080@60Hz) for Horizontal		
AC Power :	AC 230V/50Hz	Ant. Polarization:	Horizontal
Equipment :	LCD Monitor	Model No :	236LM00031
Temperature :	22°C	Humidity :	56%
Pressure(mbar) :	1001	Date:	2015/12/16

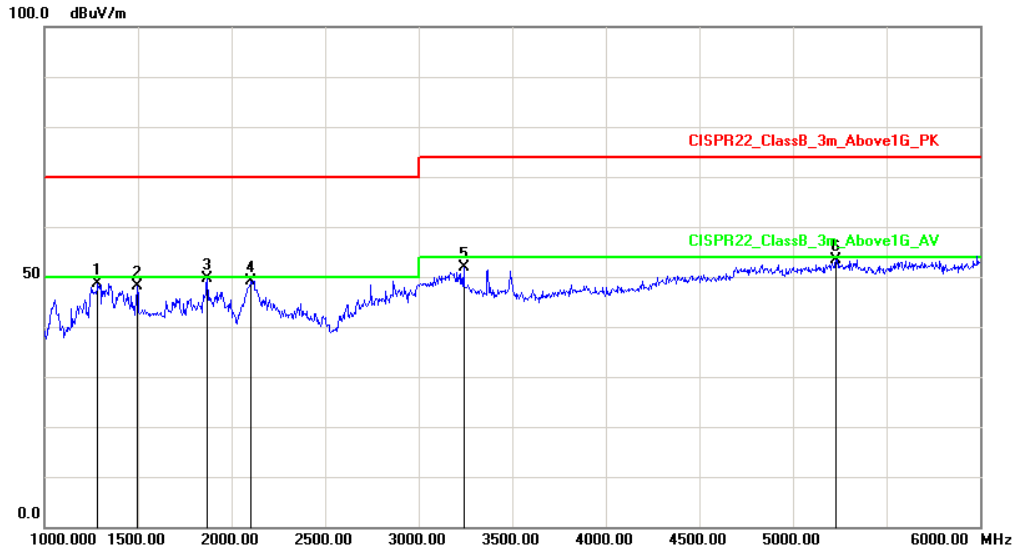

No.	Frequency (MHz)	Factor (dB/m)	Reading (dBuV)	Level (dBuV/m)	Limit (dBuV/m)	Margin (dB)	Det.	Height (cm)	Azimuth (deg)
1	1285.000	-4.08	52.64	48.56	70.00	-21.44	peak	100	235
2	1495.000	-2.67	50.87	48.20	70.00	-21.80	peak	100	128
3	1870.000	3.69	45.83	49.52	70.00	-20.48	peak	100	98
4	2105.000	4.96	44.12	49.08	70.00	-20.92	peak	100	163
5	3240.000	4.86	46.95	51.81	74.00	-22.19	peak	100	354
6	5230.000	11.60	41.89	53.49	74.00	-20.51	peak	100	260

Note: Measurement Level = Reading Level + Correct Factor



Test Mode :	Mode 9: Full system (HDMI mode 1920*1080@60Hz) for Horizontal		
AC Power :	AC 230V/50Hz	Ant. Polarization:	Vertical
Equipment :	LCD Monitor	Model No :	236LM00031
Temperature :	22°C	Humidity :	56%
Pressure(mbar) :	1001	Date:	2015/12/16

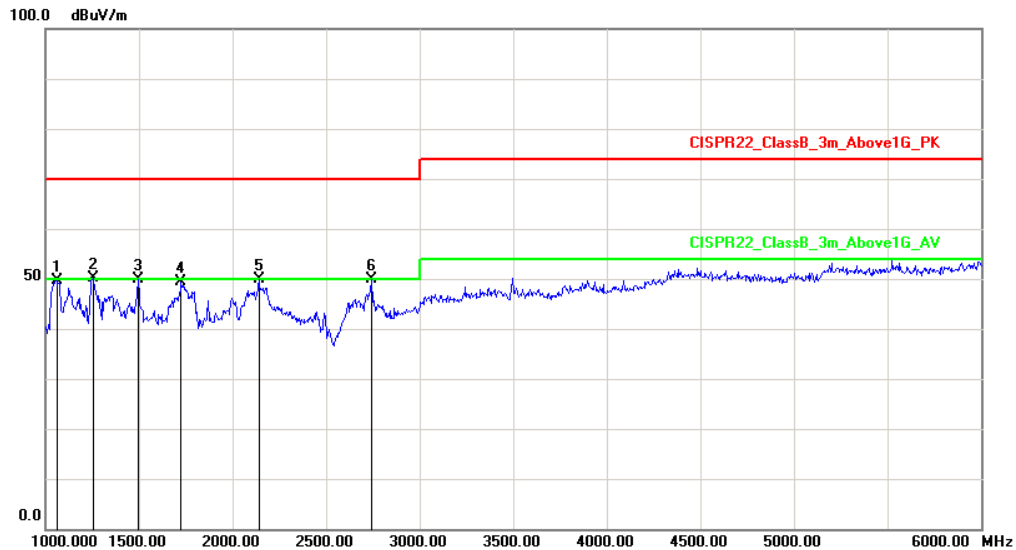

No.	Frequency (MHz)	Factor (dB/m)	Reading (dBuV)	Level (dBuV/m)	Limit (dBuV/m)	Margin (dB)	Det.	Height (cm)	Azimuth (deg)
1	1060.000	-5.58	55.30	49.72	70.00	-20.28	peak	100	351
2	1255.000	-4.28	54.49	50.21	70.00	-20.12	peak	100	2
3	1495.000	-2.67	52.50	49.83	70.00	-20.17	peak	100	159
4	1725.000	1.21	48.19	49.40	70.00	-20.60	peak	100	289
5	2140.000	4.64	45.24	49.88	70.00	-20.12	peak	100	341
6	2740.000	2.68	47.16	49.84	70.00	-20.16	peak	100	268

Note: Measurement Level = Reading Level + Correct Factor

Test engineer: Seben



### 5.7. Test Photographs (30MHz~1GHz)

First edition:

Front View

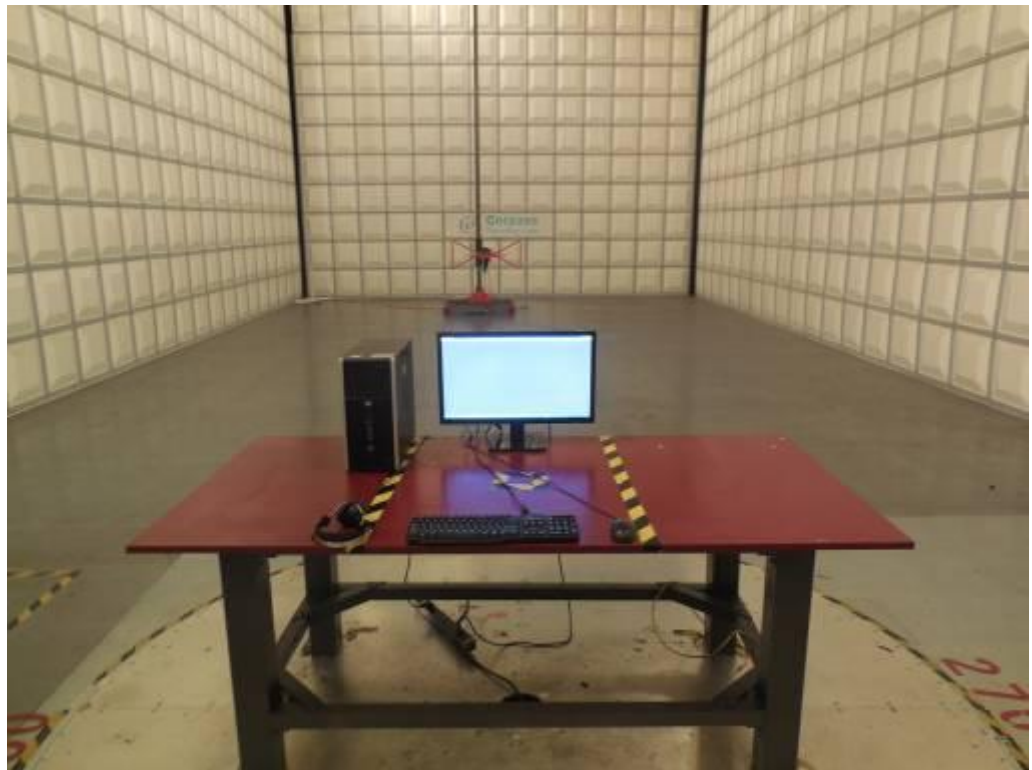

Rear View







Original:

Front View

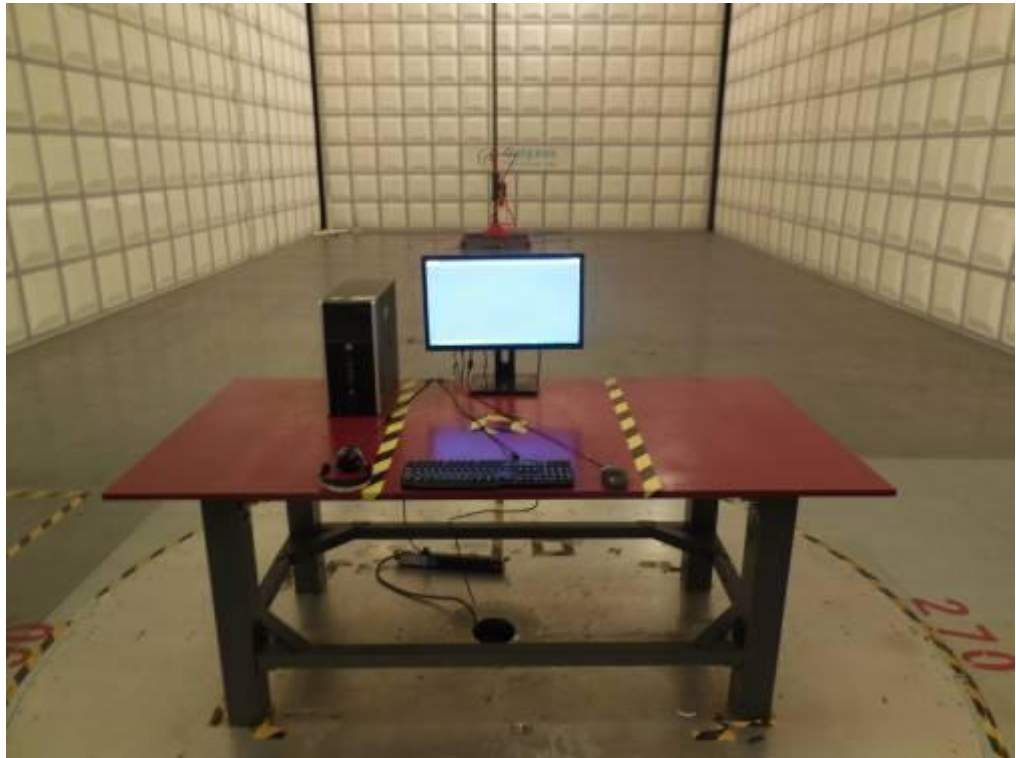

Rear View

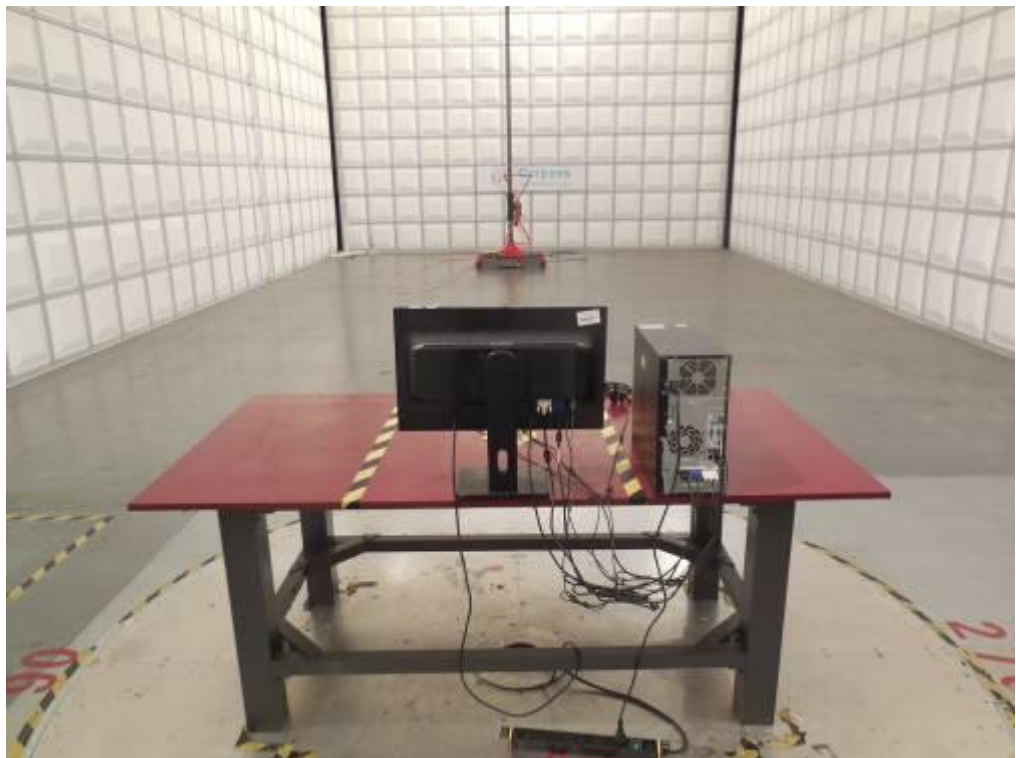



### 5.8. Test Photographs (1GHz~6GHz)

First edition:

Front View



Rear View

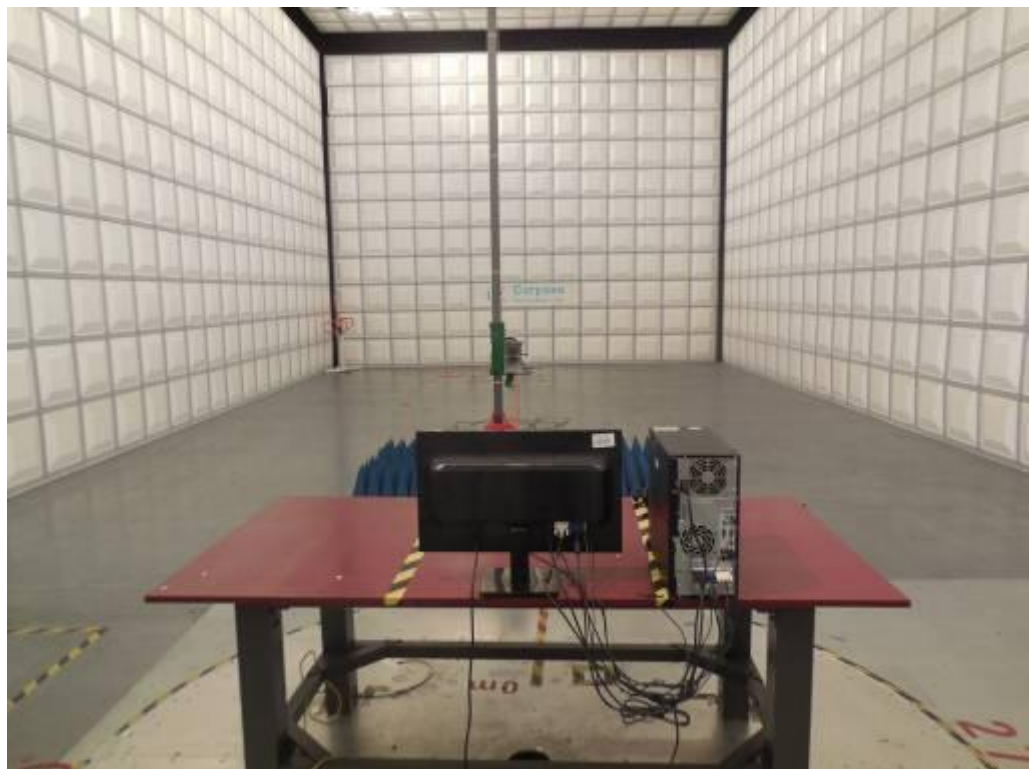



Original:

Front View

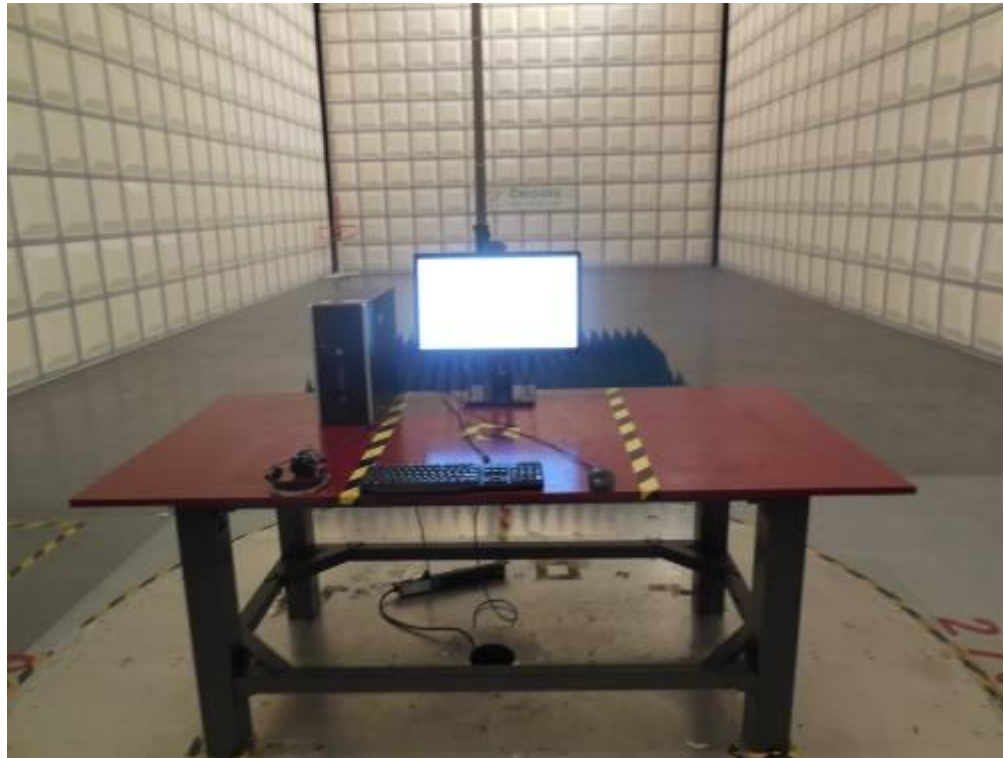

Rear View

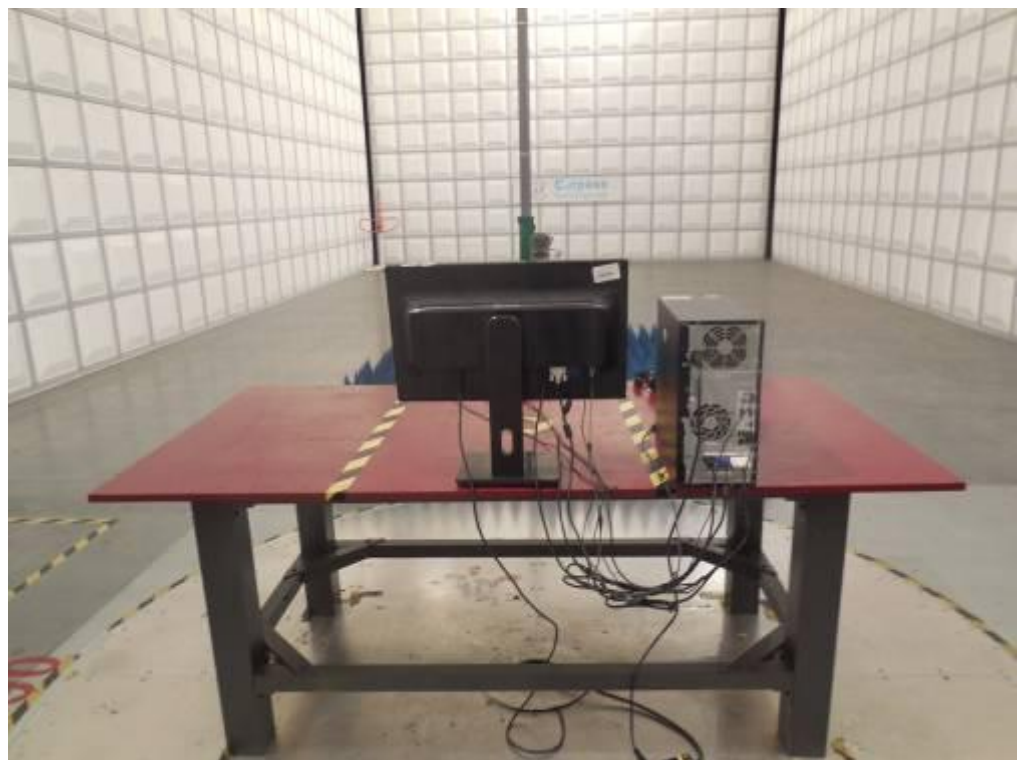



## 6. Harmonics Test

### 6.1. Limits of Harmonics Current Measurement

#### Limits for Class A equipment

Harmonics Order n	Max. permissible harmonics current A	Harmonics Order n	Max. permissible harmonics current A
Odd harmonics		Even harmonics	
3	2.30	2	1.08
5	1.14	4	0.43
7	0.77	6	0.30
9	0.40	8 ≤ n ≤ 40	0.23x8/n
11	0.33		
13	0.21		
15 ≤ n ≤ 39	0.15x15/n		

#### (b) Limits for Class B equipment

For Class B equipment, the harmonics of the input current shall not exceed the values given in Table that is the limit of Class A multiplied by a factor of 1,5.

#### (c) Limits for Class C equipment

Harmonics Order n	Maximum permissible harmonic current expressed as a percentage of the input current at the fundamental frequency %
2	2
3	$30 \cdot \lambda^*$
5	10
7	7
9	5
11 < n < 39 (odd harmonics only)	3

\*  $\lambda$  is the circuit power factor

#### (d) Limits for Class D equipment

Harmonics Order n	Maximum permissible harmonic current per watt mA/W	Maximum permissible harmonic current A
3	3.4	2.30
5	1.9	1.14
7	1.0	0.77
9	0.5	0.40
11	0.35	0.33
11 < n < 39 (odd harmonics only)	3.85/n	See limit of Class A

**NOTE:** According to section 7 of EN 61000-3-2, the above limits for all equipment except for lighting equipment having an active input power > 75 W and no limits apply for equipment with an active input power up to and including 75 W.



## 6.2. Measurement Equipment

Instrument/Ancillary	Manufacturer	Model No.	Serial No.	Calibration Date	Valid Date.
EMC Emission Tester	EMCPARTNER	Harmonics-1000	159	2015.04.02	2016.04.01
Temperature/ Humidity Meter	Zhicheng	ZC1-11	CEP-TH-004	2015.04.02	2016.04.01
HARCS	EMC Partner AG	Ver 4.18	N/A	N/A	N/A



### 6.3. Test Result and Data

Basic Standard	:	EN 61000-3-2
Final Test Result	:	PASS
Test Mode	:	Mode 1, 5, 9
Model No.	:	236LM00031
Temperature	:	21°C
Humidity	:	45%
Atmospheric Pressure	:	100 kPa
Test Date	:	Dec 10, 2015

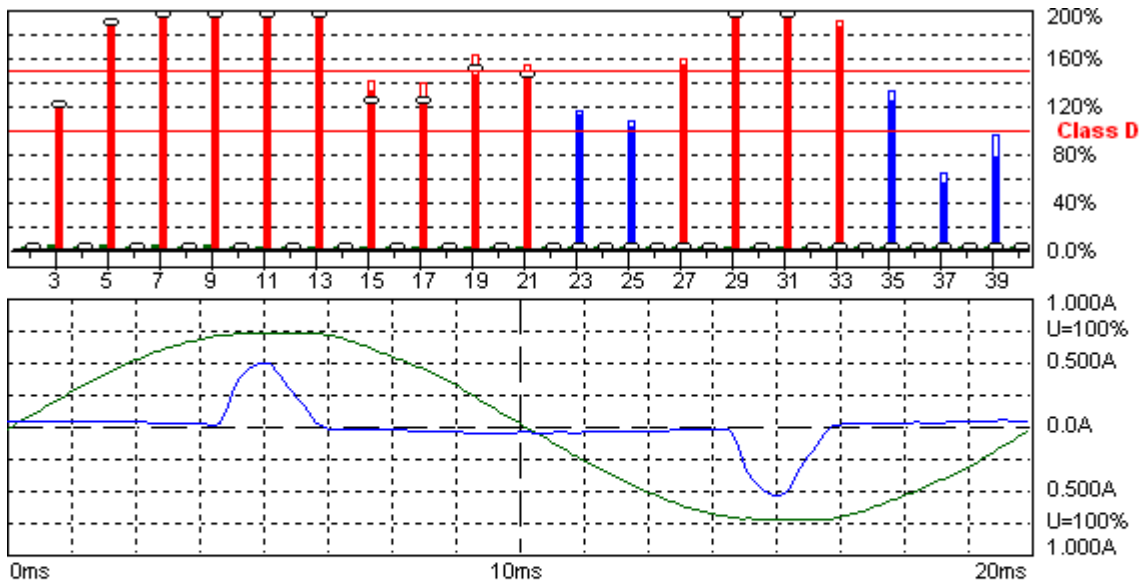

Harmonic Emission - IEC 61000-3-2, EN 61000-3-2, (EN60555-2)

2015-12-10 12:20:30

Urms = 230.7 V    P = 19.71 W    THC = 0.133 A    Range: 1 A  
 Irms = 0.161 A    pf = 0.532    Pmax = 19.89 W    V-nom: 230 V  
 TestTime: 15 min (100%)

E2475PWJ

HAR-1000 EMC-Partner

Full Bar : Actual Values

Empty Bar : Maximum Values

Blue : Current , Green : Voltage , Red : Failed

Urms = 230.7V    Freq = 50.013    Range: 1 A  
 Irms = 0.161A    Ipk = 0.553A    cf = 3.441  
 P = 19.71W    S = 37.06VA    pf = 0.532  
 THDi = 81.8 %    THDu = 1.50 %    Class D  
 Test - Time : 15min ( 100 % )  
 Limit Reference: Pmax = 19.887W  
 Test completed, Result: N/L



Order	Freq. [Hz]	Irms [A]	Irms%L [%]	I <sub>max</sub> [A]	I <sub>max</sub> %L [%]	Limit [A]	Status
1	50	0.0936		0.0940			
2	100	0.0039		0.0040			
3	150	0.0804	118.88	0.0806	119.24	0.00	N/L
4	200	0.0040		0.0040			
5	250	0.0709	187.70	0.0711	188.19	0.00	N/L
6	300	0.0037		0.0037			
7	350	0.0577	290.34	0.0582	292.49	0.00	N/L
8	400	0.0030		0.0031			
9	450	0.0410	411.88	0.0414	416.79	0.00	N/L
10	500	0.0025		0.0026			
11	550	0.0264	378.82	0.0270	387.59	0.00	N/L
12	600	0.0015		0.0016			
13	650	0.0146	248.72	0.0153	259.08	0.00	N/L
14	700	0.0005		0.0006			
15	750	0.0067	130.34	0.0071	139.90	0.00	N/L
16	800	0.0006		0.0007			
17	850	0.0054	120.61	0.0062	138.23	0.00	N/L
18	900	0.0012		0.0012			
19	950	0.0058	143.89	0.0065	160.55	0.00	N/L
20	1000	0.0013		0.0014			
21	1050	0.0053	145.64	0.0056	152.34	0.00	N/L
22	1100	0.0012		0.0012			
23	1150	0.0037	111.84	0.0038	115.51	0.00	N/L
24	1200	0.0009		0.0009			
25	1250	0.0031	99.647	0.0032	105.63	0.00	N/L
26	1300	0.0005		0.0006			
27	1350	0.0043	150.67	0.0044	154.97	0.00	N/L
28	1400	0.0005		0.0006			
29	1450	0.0052	196.50	0.0053	201.13	0.00	N/L
30	1500	0.0005		0.0007			
31	1550	0.0052	212.53	0.0054	217.47	0.00	N/L
32	1600	0.0007		0.0007			
33	1650	0.0043	184.15	0.0044	189.41	0.00	N/L
34	1700	0.0006		0.0007			
35	1750	0.0027	122.76	0.0029	131.14	0.00	N/L
36	1800	0.0005		0.0006			
37	1850	0.0011	53.092	0.0013	61.940	0.00	N/L
38	1900	0.0005		0.0005			
39	1950	0.0015	74.615	0.0018	93.269	0.00	N/L
40	2000	0.0006		0.0007			

EUT is PASSED if:

- all Average values of the Individual Harmonic Currents (I<sub>avg</sub>) are below 100% of the Individual Limits.
- all Maximum values of the Individual Harmonic Currents (I<sub>max</sub>) are below 150% of the Individual Limits.

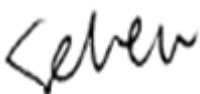
Test engineer: 



#### 6.4. Test Photographs







## 7. Voltage Fluctuations Test

### 7.1. Test Procedure

The equipment shall be tested under the conditions of **Clause 5**.

The total impedance of the test circuit, excluding the appliance under test, but including the internal impedance of the supply source, shall be equal to the reference impedance.

The stability and tolerance of the reference impedance shall be adequate to ensure that the overall accuracy of  $\pm 8\%$  is achieved during the whole assessment procedure.

### 7.2. Measurement Equipment

Instrument/Ancillary	Manufacturer	Model No.	Serial No.	Calibration Date	Valid Date.
EMC Emission Tester	EMCPARTNER	Harmonics-1000	159	2015.04.02	2016.04.01
Temperature/ Humidity Meter	Zhicheng	ZC1-11	CEP-TH-004	2015.04.02	2016.04.01
HARCS	EMC Partner AG	Ver 4.18	N/A	N/A	N/A



### 7.3. Test Result and Data

Basic Standard	:	EN 61000-3-3
Final Test Result	:	PASS
Test Mode	:	Mode 1, 5, 9
Model No.	:	236LM00031
Temperature	:	21°C
Humidity	:	45%
Atmospheric Pressure	:	100 kPa
Test Date	:	Dec 10, 2015

Flickermeter 1000-4-15 for 230V/50Hz

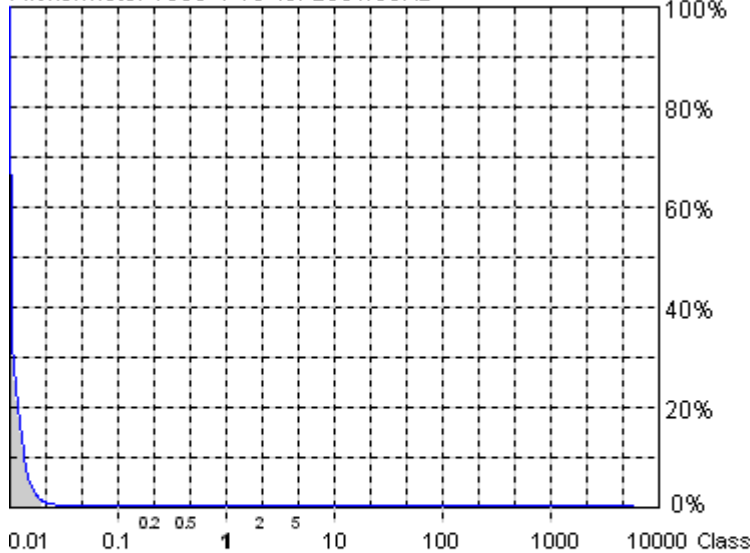

**Actual Flicker (Fli): 0.01**  
**Short-term Flicker (Pst): 0.09**  
 Limit (Pst): 1.00  
**Long-term Flicker (Plt): 0.09**  
 Limit (Plt): 0.65  
**Maximum Relative Volt. Change (dmax): 0.00%**  
 Limit (dmax): 4.00%  
**Relative Steady-state Voltage Change (dc): 0.12%**  
 Limit (dc): 3.30%  
**Maximum Interval exceeding 3.30% (dt): 0.00ms**  
 Limit (dt>Lim): 500ms

**Flicker Emission - IEC 61000-3-3 , EN 61000-3-3 , (EN60555-3)**

2015-12-10 13:26:44

Urms = 230.7 V P = 19.68 W  
Irms = 0.162 A pf = 0.526

Range: 1 A  
V-nom: 230 V  
TestTime: 10 min (100%)

E2475PWJ

**Test completed, Result: PASSED**

HAR-1000 EMC-Partner

- Full Bar : Actual Values
- Empty Bar : Maximum Values
- Circles : Average Values
- Blue : Current , Green : Voltage , Red : Failed



Urms = 230.7V Freq = 50.000 Range: 1 A  
Irms = 0.162A Ipk = 0.563A cf = 3.476  
P = 19.68W S = 37.40VA pf = 0.526

Test - Time : 1 x 10min = 10min ( 100 %)

LIN (Line Impedance Network) : No LIN

Limits : Plt : 0.65 Pst : 1.00  
dmax : 4.00 % dc : 3.30 %  
dtLim: 3.30 % dt>Lim: 500ms

Test completed, Result: PASSED

Test engineer: Seben



### 7.4. Test Photographs





## 8. Electrostatic Discharge Immunity Test

### 8.1. Test Procedure

- a. In the case of air discharge testing the climatic conditions shall be within the following ranges:
  - ambient temperature: 15°C to 35°C;
  - relative humidity : 30% to 60%;
  - atmospheric pressure : 86 KPa (860 mbar) to 106 KPa (1060 mbar).
- b. Test programs and software shall be chosen so as to exercise all normal modes of operation of the EUT. The use of special exercising software is encouraged, but permitted only where it can be shown that the EUT is being comprehensively exercised.
- c. The test voltage shall be increased from the minimum to the selected test severity level, in order to determine any threshold of failure. The final severity level should not exceed the product specification value in order to avoid damage to the equipment.
- d. The test shall be performed with both air discharge and contact discharge. On reselected points at least 10 single discharges (in the most sensitive polarity) shall be applied on air discharge. On reselected points at least 25 single discharges (in the most sensitive polarity) shall be applied on contact discharge.
- e. For the time interval between successive single discharges an initial value of one second is recommended. Longer intervals may be necessary to determine whether a system failure has occurred.
- f. In the case of contact discharges, the tip of the discharge electrode shall touch the EUT before the discharge switch is operated.
- g. In the case of painted surface covering a conducting substrate, the following procedure shall be adopted :
  - If the coating is not declared to be an insulating coating by the equipment manufacturer, then the pointed tip of the generator shall penetrate the coating so as to make contact with the conducting substrate.
  - Coating declared as insulating by the manufacturer shall only be submitted to the air discharge.
  - The contact discharge test shall not be applied to such surfaces.
- h. In the case of air discharges, the round discharge tip of the discharge electrode shall be approached as fast as possible (without causing mechanical damage) to touch the EUT . After each discharge, the ESD generator (discharge electrode) shall be removed from the EUT. The generator is then retriggered for a new single discharge. This procedure shall be repeated until the discharges are completed. In the case of an air discharge test, the discharge switch, which is used for contact discharge, shall be closed.

## 8.2. Test Setup for Tests Performed in Laboratory

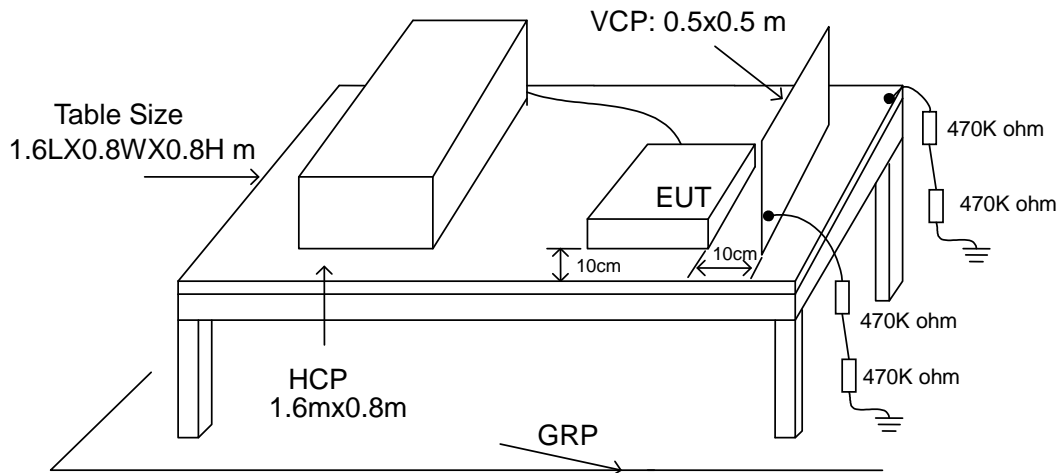

The test setup consists of the test generator, EUT and auxiliary instrumentation necessary to perform DIRECT and INDIRECT application of discharges to the EUT as applicable, in the following manner :

- a. Contact Discharge to the conductive surfaces and to coupling plane;
- b. Air Discharge at insulating surfaces.

The preferred test method is that of type tests performed in laboratories and the only accepted method of demonstrating conformance with this standard. The EUT was arranged as closely as possible to arrangement in final installed conditions.

A ground reference plane was provided on the floor of the test site. It was a metallic sheet (copper or aluminum) of 0.25 mm, minimum thickness; other metallic may be used but they shall have at least 0.65 mm thickness. In the CerpPASS Technology Corp., we provided 1 mm thickness stainless steel ground reference plane. The minimum size of the ground reference plane is 2.5 m x 2.5 m, the exact size depending on the dimensions of the EUT. It was connected to the protective grounding system.

The EUT was arranged and connected according to its functional requirements. A distance of 1m minimum was provided between the EUT and the wall of the lab. and any other metallic structure. In cases where this length exceeds the length necessary to apply the discharges to the selected points, the excess length shall, where possible, be placed non-inductively off the ground reference plane and shall not come closer than 0.2m to other conductive parts in the test setup.

Where the EUT is installed on a metal table, the table was connected to the reference plane via a cable with a 470k ohm resistor located at each end, to prevent a build-up of charge. The test setup was consist a wooden table, 0.8m high, standing on the ground reference plane. A HCP, 1.6 m x 0.8 m, was placed on the table. The EUT and cables was isolated from the HCP by an insulating support 0.5 mm thick. The VCP size, 0.5 m x 0.5 m.



### 8.3. Test Severity Levels

Contact Discharge		Air Discharge	
Level	Test Voltage (KV) of Contact discharge	Level	Test Voltage (KV) of Air Discharge
1	±2	1	±2
2	±4	2	±4
3	±6	3	±8
4	±8	4	±15
X	Specified	X	Specified

Remark: "X" is an open level.

### 8.4. Measurement Equipment

Instrument/Ancillary	Manufacturer	Model No.	Serial No.	Calibration Date	Valid Date.
ESD Simulator	EM Test	dito	V0714102399	2015.03.29	2016.03.28
Tonometer	shanghaifengyun	DYM3	3251	2015.12.01	2016.11.30
Dehumidifier	ZEDO	ZD-220LB	CEP-TH-01	N/A	N/A
Humidifier	YADU	YZ-DS251C	CEP-TH-02	N/A	N/A
Temperature/ Humidity Meter	feiyun	N/A	102	2015.04.02	2016.04.01



8.5. Test Result and Data

Final Test Result : **PASS**  
 Pass performance criteria : B  
 Basic Standard : IEC 61000-4-2  
 Model No. : 236LM00031  
 Test Voltage : ±2 / ±4 / ±8 KV for air discharge,  
 ±2 / ±4 KV for contact discharge  
 Temperature : 20°C  
 Relative Humidity : 49 %  
 Atmospheric Pressure : 100 kPa  
 Test Date : Dec 14, 2015

Test Mode : Mode 1, 5, 9

	Contact Discharge								Air Discharge							
	25 times / each								10 times / each							
Voltage	2 Kv		4 Kv		6 Kv		8 Kv		2 Kv		4 Kv		8 Kv		10 Kv	
Point\Polarity	+	-	+	-	+	-	+	-	+	-	+	-	+	-	+	-
HCP	A	A	A	A	---	---	---	---	---	---	---	---	---	---	---	---
VCP	A	A	A	A	---	---	---	---	---	---	---	---	---	---	---	---
Screw	A	A	A	A	---	---	---	---	---	---	---	---	---	---	---	---
Case	---	---	---	---	---	---	---	---	A	A	A	A	A	A	---	---
Panel	---	---	---	---	---	---	---	---	A	A	A	A	A	A	---	---
VGA Port	A	A	A	A	---	---	---	---	A	A	A	A	A	A	---	---
DVI Port	A	A	A	A	---	---	---	---	A	A	A	A	A	A	---	---
HDMI Port	A	A	A	A	---	---	---	---	A	A	A	A	A	A	---	---
Audio Port	---	---	---	---	---	---	---	---	A	A	A	A	A	A	---	---
Power Port	---	---	---	---	---	---	---	---	A	A	A	A	A	A	---	---
Button	---	---	---	---	---	---	---	---	A	A	A	A	A	A	---	---
LED Light	---	---	---	---	---	---	---	---	A	A	A	A	A	A	---	---

Test engineer: Seben





### 8.6. Test Photographs





## 9. Radio Frequency electromagnetic field immunity test

### 9.1. Test Procedure

- a. The equipment to be tested is placed in the center of the enclosure on a wooden table. The equipment is then connected to power and signal leads according to pertinent installation instructions.
- b. The antenna which is enabling the complete frequency range of 80-1000 MHz is placed 3m away from the equipment. The required field strength is determined by placing the field strength meter(s) on top of or directly alongside the equipment under test and monitoring the field strength meter via a remote field strength indicator outside the enclosure while adjusting the continuous-wave to the applicable antennae.
- c. The test is normally performed with the antenna facing the most sensitive side of the EUT. The polarization of the field generated by the bucolical antenna necessitates testing each position twice, once with the antenna positioned vertically and again with the antenna positioned horizontally. The circular polarization of the field from the log-spiral antenna makes a change of position of the antenna unnecessary.
- d. At each of the above conditions, the frequency range is swept 80-1000 MHz, pausing to adjust the R.F. signal level or to switch oscillators and antenna. The rate of sweep is in the order of  $1.5 \cdot 10^{-3}$  decades/s. The sensitive frequencies or frequencies of dominant interest may be discretely analyzed.

### 9.2. Test Severity Levels

Frequency Band : 80-1000 MHz	
Level	Test field strength (V/m)
1	1
2	3
3	10
X	Specified
Remark: "X" is an open class.	

### 9.3. TEST SETUP

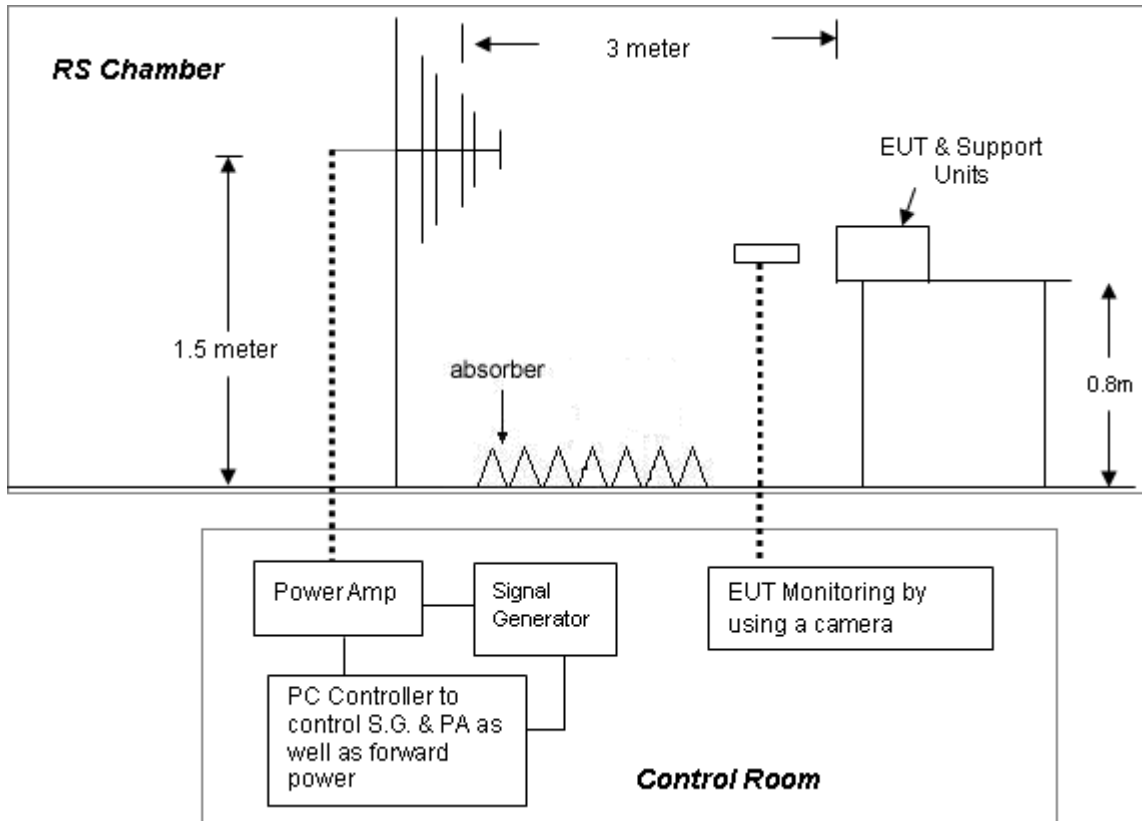

- For the actual test configuration, please refer to the related item – Photographs of the Test Configuration.

#### NOTE:

##### TABLETOP EQUIPMENT

The EUT installed in a representative system as described in section 7 of IEC 61000-4-3 was placed on a non-conductive table 0.8 meters in height. The system under test was connected to the power and signal wire according to relevant installation instructions.

##### FLOOR STANDING EQUIPMENT

The EUT installed in a representative system as described in section 7 of IEC 61000-4-3 was placed on a non-conductive wood support 0.1 meters in height. The system under test was connected to the power and signal wire according to relevant installation instructions.



#### 9.4. Measurement Equipment

Instrument/Ancillary	Manufacturer	Model No.	Serial No.	Calibration Date	Valid Date.
Signal Generator	R&S	SML03	103287	2015.03.29	2016.03.28
Power Sensor	R&S	NR P-Z91	100383	2015.03.29	2016.03.28
Power Sensor	R&S	NRP-Z91	100384	2015.03.29	2016.03.28
Power Meter	R&S	NRP	101206	2015.03.29	2016.03.28
Power Amplifier	BONN	BLWA0830-16 0/100/40D	076659	2015.03.29	2016.03.28
Istropic Electric Field Probe	EST.LINDGRE N	HI-6105	137445	2015.10.21	2016.10.22
EMS Antenna	R&S	HL046E	100028	N/A	N/A
Temperature/ Humidity Meter	feiyang	N/A	101	2015.04.02	2016.04.01
EMC-32	Rohde&Schwa rz	Ver 6.10.0	N/A	N/A	N/A



9.5. Test Result and Data

First edition:

- Final Test Result : **PASS**
- Pass performance criteria : A
- Basic Standard : IEC 61000-4-3
- Model No. : 236LM00031
- Frequency Range : 80~1000 MHz
- Temperature : 23°C
- Relative Humidity : 55%
- Atmospheric Pressure : 100 kPa
- Test Date : Dec 23, 2015

Test Mode: Mode 1, 4, 7

Modulation : AM 80% , 1KHz sine wave , Dwell time: 3.0 S				
Frequency Step Size : 1 % of preceding frequency value				
Frequency (MHz)	Antenna Polarization	face	Field strength (V/m)	Result
80~1000	Vertical	Front	3 V/m	A
80~1000	Vertical	Rear	3 V/m	A
80~1000	Vertical	Left	3 V/m	A
80~1000	Vertical	Right	3 V/m	A
80~1000	Horizontal	Front	3 V/m	A
80~1000	Horizontal	Rear	3 V/m	A
80~1000	Horizontal	Left	3 V/m	A
80~1000	Horizontal	Right	3 V/m	A

Test engineer: Seben



Original:

Final Test Result : **PASS**  
 Pass performance criteria : A  
 Basic Standard : IEC 61000-4-3  
 Model No. : 236LM00031  
 Frequency Range : 80~1000 MHz  
 Temperature : 19°C  
 Relative Humidity : 50 %  
 Atmospheric Pressure : 100 kPa  
 Test Date : Dec 14, 2015

Test Mode: Mode 1, 5, 9

Modulation : AM 80% , 1KHz sine wave , Dwell time: 3.0 S  
 Frequency Step Size : 1 % of preceding frequency value

Frequency (MHz)	Antenna Polarization	face	Field strength (V/m)	Result
80~1000	Vertical	Front	3 V/m	A
80~1000	Vertical	Rear	3 V/m	A
80~1000	Vertical	Left	3 V/m	A
80~1000	Vertical	Right	3 V/m	A
80~1000	Horizontal	Front	3 V/m	A
80~1000	Horizontal	Rear	3 V/m	A
80~1000	Horizontal	Left	3 V/m	A
80~1000	Horizontal	Right	3 V/m	A

Test engineer: Seben



### 9.6. Test Photographs

First edition:

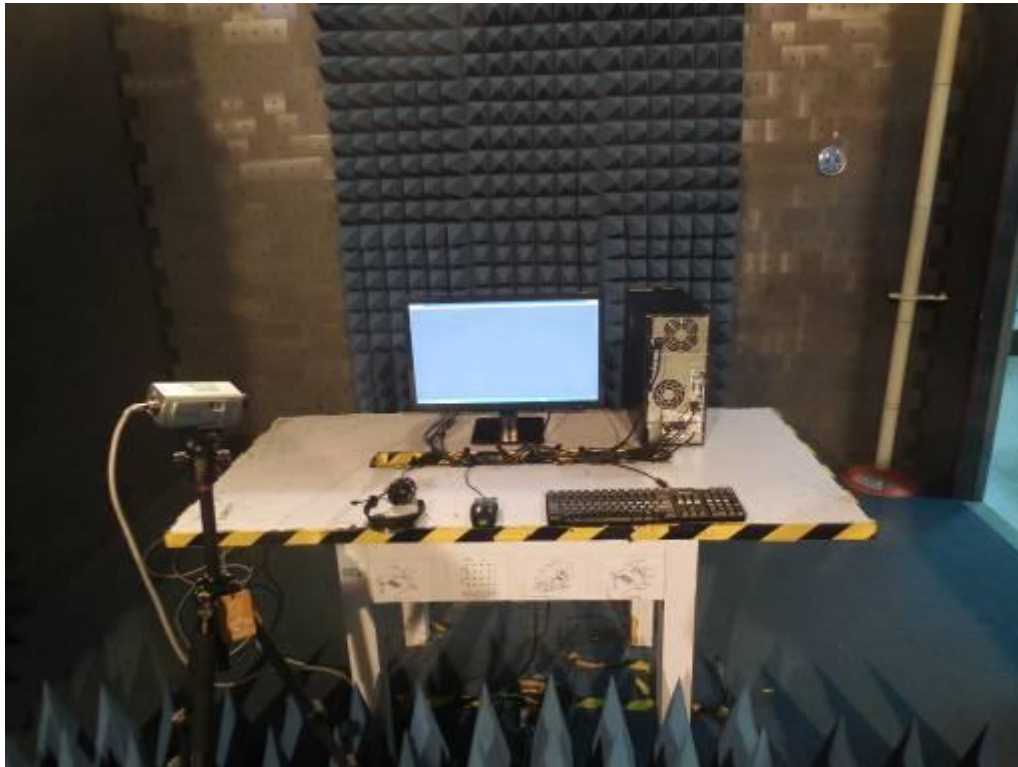

Original:





## 10. Electrical Fast Transient/ Burst Immunity Test

### 10.1. Test Procedure

- a. In order to minimize the effect of environmental parameters on test results, the climatic conditions when test is carrying out shall comply with the following requirements:
  - ambient temperature: 15°C to 35°C;
  - relative humidity : 45% to 75%;
  - Atmospheric pressure: 86 Kpa (860 mbar) to 106 Kpa (1060 mbar).
- b. In order to minimize the effect of environmental parameters on test results, the electromagnetic environment of the laboratory shall not influence the test results.
- c. The variety and diversity of equipment and systems to be tested make it difficult to establish general criteria for the evaluation of the effects of fast transients/bursts on equipment and systems.
- d. Test on Power Line:
  - The EFT/B-generator was located on the GRP.  
For floor standing equipment 1,0 m  
For table top equipment 0,5 m
  - The EFT/B-generator provides the ability to apply the test voltage in a non-symmetrical condition to the power supply input terminals of the EUT.
- e. Test on Communication Lines
  - The coupling clamp is composed of a clamp unit for housing the cable (length more than 3 m), and was placed on the GRP.
  - The coupling clamp provides the ability of coupling the fast transient/bursts to the cable under test.
- f. The test results may be classified on the basic of the operating conditions and the functional specification of the equipment under test, according to the following performance criteria :
  - Normal performance within the specification limits.
  - Temporary degradation or loss of function or performance which is self-recoverable.
  - Temporary degradation or loss of function or performance which requires operator intervention or system reset.
  - Degradation or loss of function which is not recoverable due to damage of equipment (components).

### 10.2. Test Severity Levels

The following test severity levels are recommended for the fast transient/burst test :

Open circuit output test voltage $\pm 10\%$		
Level	On Power Supply	On I/O signal, data and control line
1	0.5 KV	0.25 KV
2	1.0 KV	0.50 KV
3	2.0 KV	1.00 KV
4	4.0 KV	2.00 KV
X	Specified	Specified

Remark : “ X ” is an open level. The level is subject to negotiation between the user and manufacturer or is specified by the manufacturer.



### 10.3. TEST SETUP

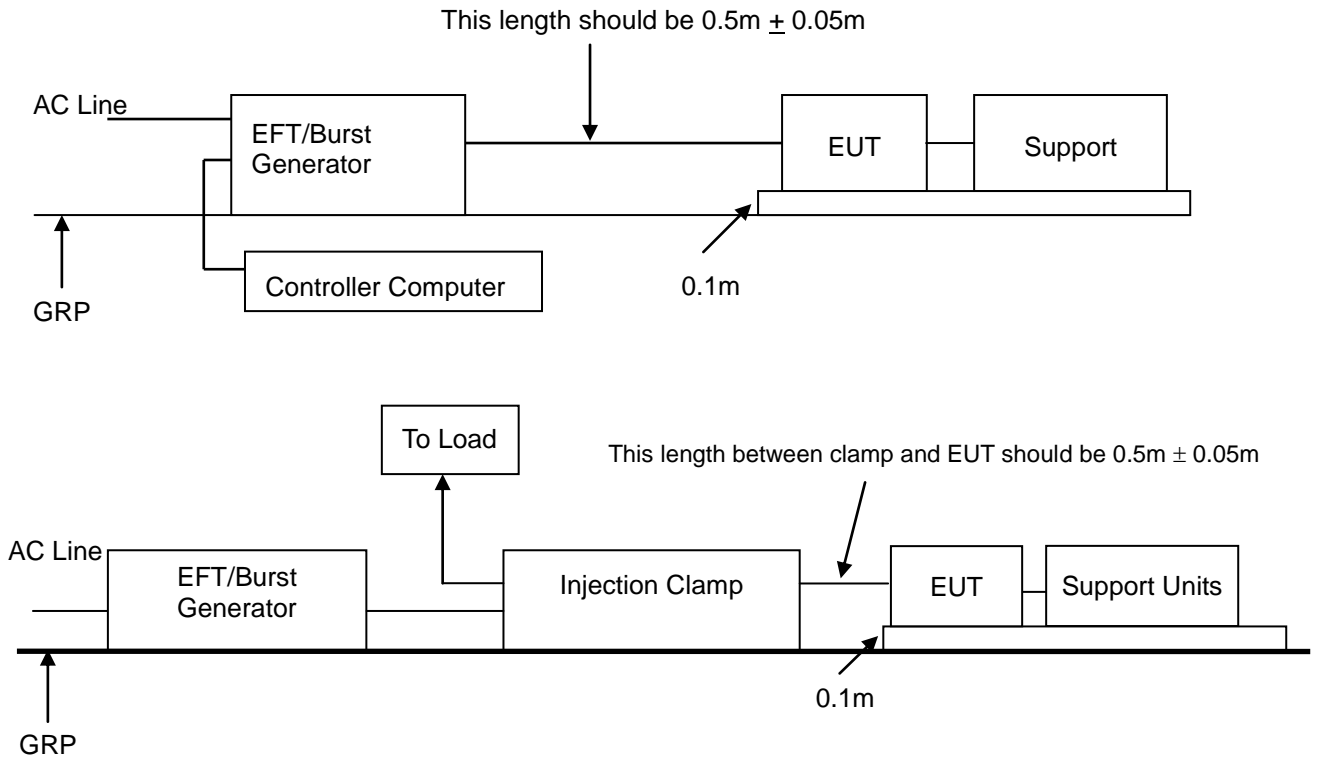

- For the actual test configuration, please refer to the related item – Photographs of the Test Configuration.

**NOTE:**

**TABLETOP EQUIPMENT**

The configuration consisted of a wooden table (0.1m high) standing on the Ground Reference Plane. The GRP consisted of a sheet of aluminum (at least 0.25mm thick and 2.5m square) connected to the protective grounding system. A minimum distance of 0.5m was provided between the EUT and the walls of the laboratory or any other metallic structure.

**FLOOR STANDING EQUIPMENT**

The EUT installed in a representative system as described in section 7 of IEC 61000-4-4 and its cables, were isolated from the Ground Reference Plane by an insulating support that is 0.1-meter thick. The GRP consisted of a sheet of aluminum (at least 0.25mm thick and 2.5m square) connected to the protective grounding system.

### 10.4. Measurement Equipment

Instrument/Ancillary	Manufacturer	Model No.	Serial No.	Calibration Date	Valid Date.
TRANSIENT	EMCPARTNER	TRA2000IN6	901	2015.03.29	2016.03.28
CDN	EMCPARTNER	CDN2000-06-32	121	2015.03.29	2016.03.28
Coupling clamp	EMCPARTNER	CN-EFT1000	547	2015.03.29	2016.03.28
Temperature/ Humidity Meter	Zhicheng	ZC1-11	CEP-TH-005	2015.04.02	2016.04.01





### 10.6. Test Photographs

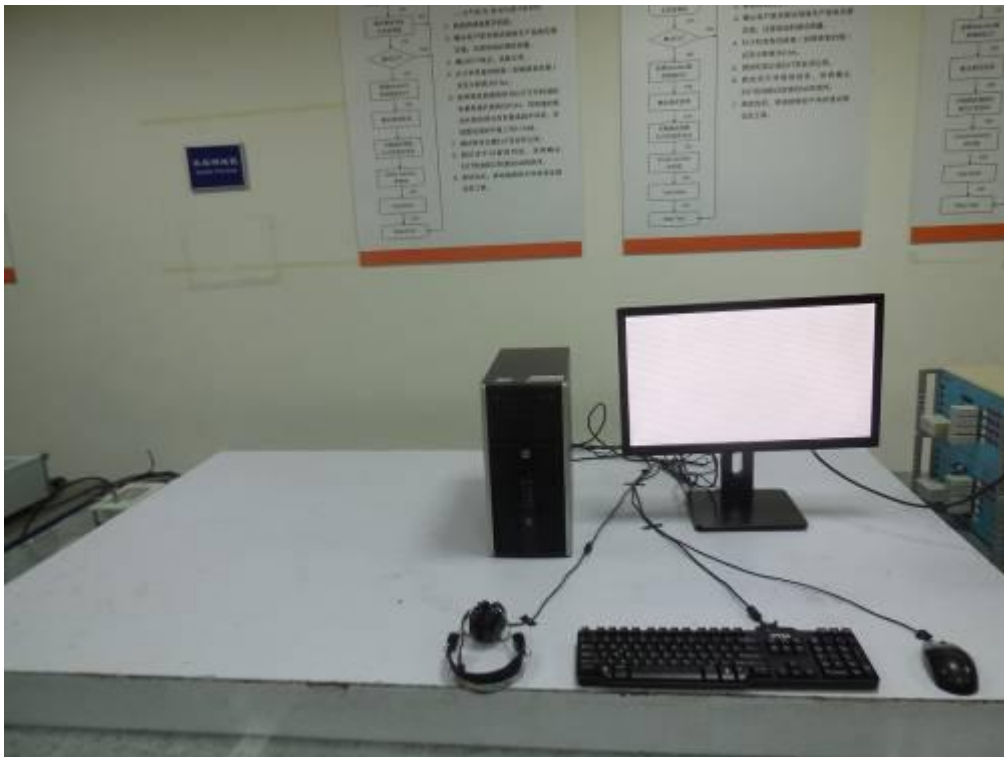



## 11. Surge Immunity Test

### 11.1. Test Procedure

- a. Climatic conditions  
The climatic conditions shall comply with the following requirements :
  - ambient temperature : 15 °C to 35 °C
  - relative humidity : 10 % to 75 %
  - atmospheric pressure : 86 kPa to 106 kPa ( 860 mbar to 1060 mbar )
- b. Electromagnetic conditions  
the electromagnetic environment of the laboratory shall not influence the test results.
- c. The test shall be performed according the test plan that shall specify the test set-up with
  - generator and other equipment utilized;
  - test level ( voltage/current );
  - generator source impedance;
  - internal or external generator trigger;
  - number of tests : at least five positive and five negative at the selected points;
  - repetition rate : maximum 1/min.
  - inputs and outputs to be tested;
  - representative operating conditions of the EUT;
  - sequence of application of the surge to the circuit;
  - phase angle in the case of AC. power supply;
  - actual installation conditions, for example :
    - AC : neutral earthed,
    - DC : ( + ) or ( - ) earthed to simulated the actual earthing conditions.
- d. If not otherwise specified the surges have to be applied synchronized to the voltage phase at the zero-crossing and the peak value of the AC. voltage wave ( positive and negative ).
- e. The surges have to be applied line to line and line(s) and earth. When testing line to earth, the test voltage has to be applied successively between each of the lines and earth, if there is no other specification.
- f. The test procedure shall also consider the non-linear current-voltage characteristics of the equipment under test. Therefore the test voltage has to be increased by steps up to the test level specified in the product standard or test plan.
- g. All lower levels including the selected test level shall be satisfied. For testing the secondary protection, the output voltage of the generator shall be increased up to the worst-case voltage breakdown level ( let-through level ) of the primary protection.
- h. If the actual operating signal sources are not available, that may be simulated. Under no circumstances may the test level exceed the product specification. The test shall be carried out according to a test plan.
- i. To find all critical points of the duty cycle of the equipment, a sufficient number of positive and negative test pulses shall be applied. For acceptance test previously unstressed equipment shall be used to the protection devices shall be replaced.

### 11.2. Test Severity Level

Level	Open-circuit test voltage, $\pm 10\%$ , KV
1	0.5
2	1.0
3	2.0
4	4.0
X	Specified
NOTE: "X" is an open class. This level can be specified in the product specification.	



### 11.3. TEST SETUP

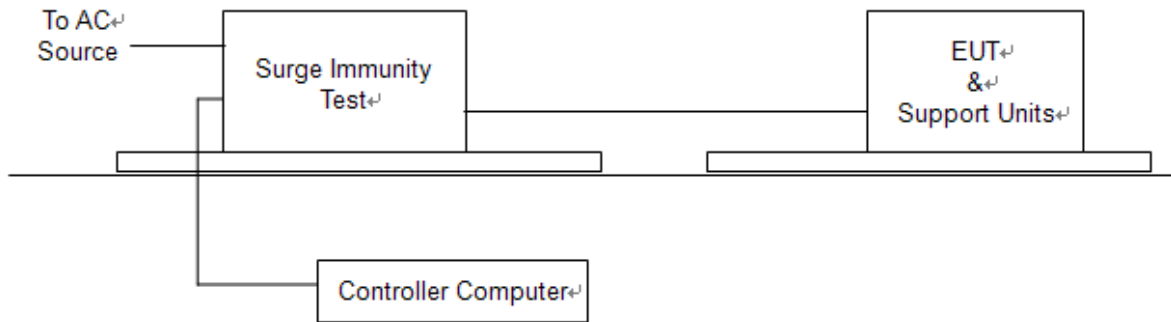

For the actual test configuration, please refer to the related item – Photographs of the Test Configuration.

### 11.4. Measurement Equipment

Instrument/Ancillary	Manufacturer	Model No.	Serial No.	Calibration Date	Valid Date.
TRANSIENT	EMCPARTNER	TRA2000IN6	901	2015.03.29	2016.03.28
CDN	EMCPARTNER	CDN-UTP8	021	2015.03.29	2016.03.28
CDN	EMCPARTNER	CDN2000-06-32	121	2015.03.29	2016.03.28
Temperature/ Humidity Meter	Zhicheng	ZC1-11	CEP-TH-005	2015.04.02	2016.04.01





### 11.6. Test Photographs

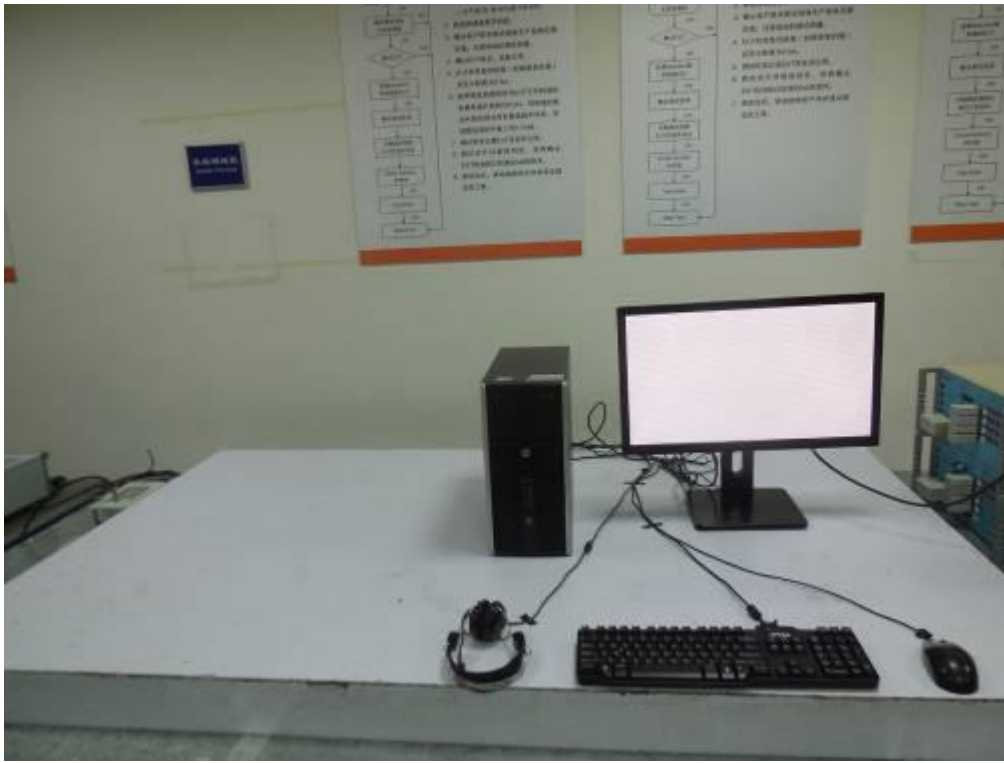



## 12. Conduction Disturbances induced by Radio-Frequency Fields

### 12.1. Test Procedure

- a. The EUT shall be operated within its intended climatic conditions. The temperature and relative humidity should be recorded.
- b. This test method test can be performed without using a sell shielded enclosure. This is because the disturbance levels applied and the geometry of the setups are not likely to radiated a high amount of energy, especially at the lower frequencies. If under certain circumstances the radiated energy is too high, a shielded enclosure has to be used.
- c. The test shall be performed with the test generator connected to each of the coupling and decoupling devices in turn while the other non-excited RF-input ports of the coupling devices are terminated by a 50 ohm load resistor.
- d. The frequency range is swept from 150 KHz to 80 MHz, using the signal levels established during the setting process, and with the disturbance signal 80% amplitude modulated with a 1KHz sign wave, pausing to adjust the RF-signal level or to switch coupling devices as necessary. The rate of sweep shall no exceed  $1.5 \times 10^{-3}$  decades/s. Where the frequency is swept incrementally, the step size shall no exceed 1% of the start and thereafter 1% of the preceding frequency value.
- e. The dwell time at each frequency shall not be less than the time necessary for the EUT to be exercised, and able to respond. Sensitive frequencies e.g. clock frequency (ies) and harmonics or frequencies of dominant interest shall be analyzed separately.
- f. An alternative test procedure may be adopted, wherein the frequency range is swept incrementally, with a step size not exceeding 4% of the start ad thereafter 4% of the preceding frequency value. The test level should be at least twice the value of the specified test level.
- g. In cases of dispute, the test procedure using a step size not exceeding 1% of the start and thereafter 1% of preceding frequency value shall take precedence.
- h. Attempts should be made to fully exercise the EUT during testing, and to fully interrogate all exercise modes selected for susceptibility.
- i. The use of special exercising programs is recommended.
- j. Testing shall be performed according to a Test Plan, which shall be included in the test report.
- k. It may be necessary to carry out some investigatory testing in order to establish some aspects of the test plan.

### 12.2. Test Severity Levels

Level	Voltage Level ( e.m.f. )
1	1 V
2	3 V
3	10 V
x	Specified
NOTE - x is an open class. This level can be specified in the product specification.	



### 12.3. TEST SETUP

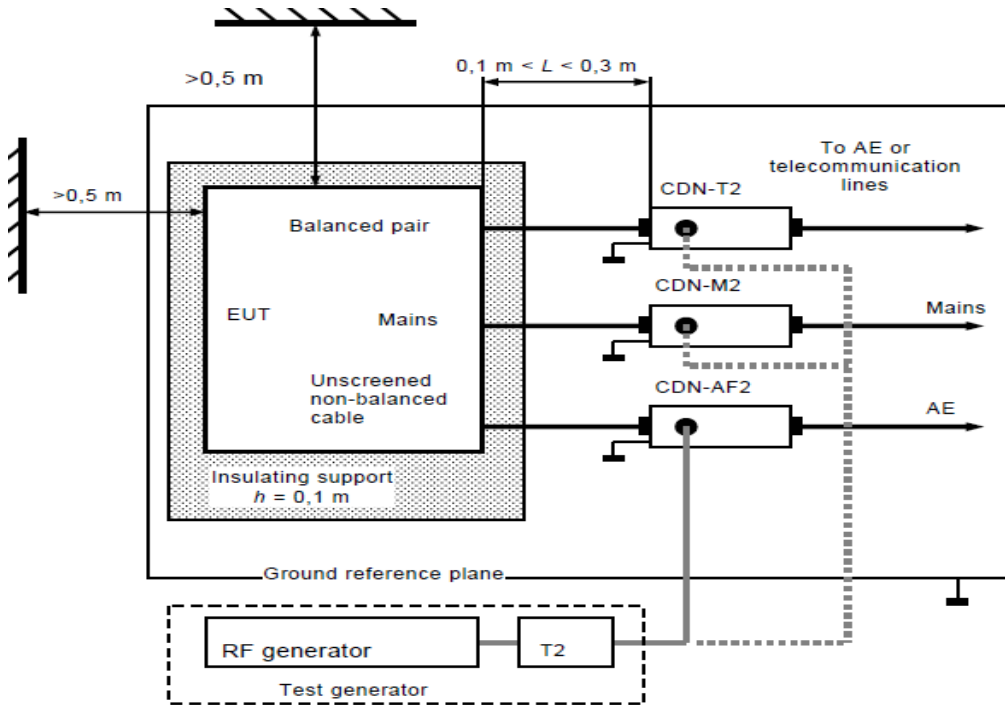

- Note:**
1. The EUT is setup 0.1m above Ground Reference Plane
  2. The CDNs and / or EM clamp used for real test depends on ports and cables configuration of EUT.
  3. For the actual test configuration, please refer to the related item – Photographs of the Test Configuration.

### 12.4. Measurement Equipment

Instrument/Ancillary	Manufacturer	Model No.	Serial No.	Calibration Date	Valid Date.
Conducted immunity test system	FRANKONIA	CIT-10/75	102D1294	2015.03.29	2016.03.28
EM Injection clamp	FCC	F-203I-23MM	536	2015.03.29	2016.03.28
CDN	FRANKONIA	CDN-T2	A3010029	2015.03.29	2016.03.28
CDN	FRANKONIA	CDN-T4	A3015017	2015.03.29	2016.03.28
CDN	FRANKONIA	CDN-T8	A3022010	2015.03.29	2016.03.28
CDN	FRANKONIA	CDN-M2	A3002037	2015.03.29	2016.03.28
CDN	FRANKONIA	CDN-M2+M3	A3011102	2015.03.29	2016.03.28
CDN	FCC	CDN-M5/32	A3013024	2015.03.29	2016.03.28
6 dB Attenuator	FRANKONIA	N/A	N/A	2015.03.29	2016.03.28
Temperature/ Humidity Meter	Zhicheng	ZC1-11	CEP-TH-005	2015.04.02	2016.04.01
EN61000-4-6	Hubert GmbH	Ver 2.21	N/A	N/A	N/A





### 12.6. Test Photographs



### 13. Power Frequency Magnetic Field Immunity Test

#### 13.1. Test Setup

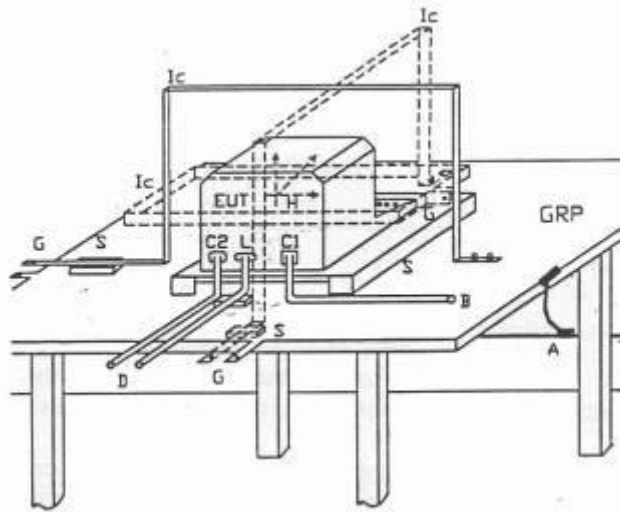

- GPR : Ground plane
- A : Safety earth
- S : Insulating support
- EUT : Equipment under test
- Lc : Induction coil
- E : Earth terminal
- C1 : Power supply circuit
- C2 : Signal circuit
- L : Communication line
- B : To power supply source
- D : To signal source, simulator
- G : To the test generator

#### 13.2. Test Severity Levels

Level	Magnetic field strength (A/m)
1	1
2	3
3	10
4	30
5	100
X <sup>1)</sup>	special

NOTE 1 "X" is an open level. This level can be given in the product specification.

#### 13.3. Measurement Equipment

Instrument/Ancillary	Manufacturer	Model No.	Serial No.	Calibration Date	Valid Date.
TRANSIENT	EMCPARTNER	TRA2000IN6	901	2015.03.29	2016.03.28
H-Filed-Loop	EMCPARTNER	MF1000-1	144	2015.03.29	2016.03.28
Temperature/ Humidity Meter	Zhicheng	ZC1-11	CEP-TH-005	2015.04.02	2016.04.01



13.4. Test Result and Data

First edition:

Final Test Result : **PASS**  
 Pass performance criteria : A  
 Basic Standard : IEC 61000-4-8  
 Model No. : 236LM00031  
 Temperature : 22°C  
 Relative Humidity : 54 %  
 Atmospheric Pressure : 100kPa  
 Test Date : Dec 24, 2015

Test Mode: Mode 1, 4, 7

Power Frequency Magnetic Field : <u>50</u> Hz, <u>1</u> A/m		
Coil Orientation	Testing duration	Results
X-axis	1.0 Min	A
Y-axis	1.0 Min	A
Z-axis	1.0 Min	A
Power Frequency Magnetic Field : <u>60</u> Hz, <u>1</u> A/m		
Coil Orientation	Testing duration	Results
X-axis	1.0 Min	A
Y-axis	1.0 Min	A
Z-axis	1.0 Min	A

Test engineer: Seben



Original:

Final Test Result : **PASS**  
Pass performance criteria : A  
Basic Standard : IEC 61000-4-8  
Model No. : 236LM00031  
Temperature : 18°C  
Relative Humidity : 47 %  
Atmospheric Pressure : 100kPa  
Test Date : Dec 14, 2015

Test Mode: Mode 1, 5, 9

Power Frequency Magnetic Field : <u>50</u> Hz, <u>1</u> A/m		
Coil Orientation	Testing duration	Results
X-axis	1.0 Min	A
Y-axis	1.0 Min	A
Z-axis	1.0 Min	A
Power Frequency Magnetic Field : <u>60</u> Hz, <u>1</u> A/m		
Coil Orientation	Testing duration	Results
X-axis	1.0 Min	A
Y-axis	1.0 Min	A
Z-axis	1.0 Min	A

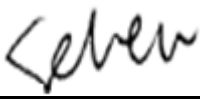
Test engineer: 



### 13.5. Test Photographs

First edition:



Original:



## 14. Voltage Dips and Voltage Interruptions Immunity Test Setup

### 14.1. Test Conditions

1. Source voltage and frequency : AC 100/230/240V / 50Hz, Single phase.
2. Test of interval : 10 sec.
3. Level and duration : Sequence of 3 dips/interrupts.
4. Voltage rise (and fall) time : 1 ~ 5  $\mu$ s.
5. Test severity :

Voltage dips and Interrupt reduction (%)	Test Duration (period)
>95%	250
30%	25
>95%	0.5

### 14.2. TEST SETUP

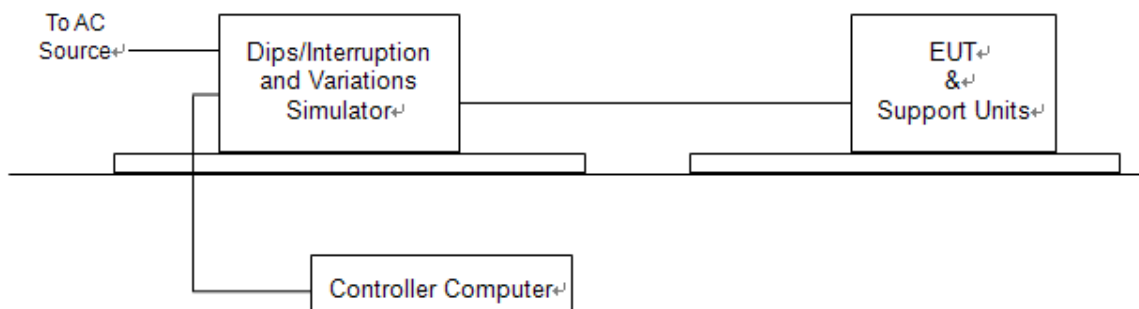

For the actual test configuration, please refer to the related item – Photographs of the Test Configuration.

### 14.3. Measurement Equipment

Instrument/Ancillary	Manufacturer	Model No.	Serial No.	Calibration Date	Valid Date.
TRANSIENT	EMCPARTNER	TRA2000IN6	901	2015.03.29	2016.03.28
Temperature/ Humidity Meter	Zhicheng	ZC1-11	CEP-TH-005	2015.04.02	2016.04.01





14.4. Test Result and Data

Final Test Result : **PASS**  
 Pass performance Criteria : C for voltage interruption, B for voltage dips  
 Basic Standard : IEC 61000-4-11  
 Model No. : 236LM00031  
 Temperature : 18°C  
 Relative Humidity : 47 %  
 Atmospheric Pressure : 100 kPa  
 Test Date : Dec 14, 2015

Test Mode: Mode 1, 5, 9

Voltage(UT): AC 230 V/240V 50 Hz Interval(s) : 10s Times : 3										
Test mod	Test level UT %	Durations (period / ms )	Phase / Result							
			0	45	90	135	180	225	270	315
Voltage interruptions	>95%	250	C	C	C	C	C	C	C	C
Voltage dips	30%	25	B	B	B	B	B	B	B	B
	>95%	0.5	B	B	B	B	B	B	B	B

Test Mode: Mode 1, 5, 9

Voltage(UT): AC 100 V 50 Hz Interval(s) : 10s Times : 3										
Test mod	Test level UT %	Durations (period / ms )	Phase / Result							
			0	45	90	135	180	225	270	315
Voltage interruptions	>95%	250	C	C	C	C	C	C	C	C
Voltage dips	30%	25	B	B	B	B	B	B	B	B
	>95%	0.5	B	B	B	B	B	B	B	B

Test engineer: Seben



### 14.5. Test Photographs





## 15. Photographs of EUT

First edition:

1) EUT Photo

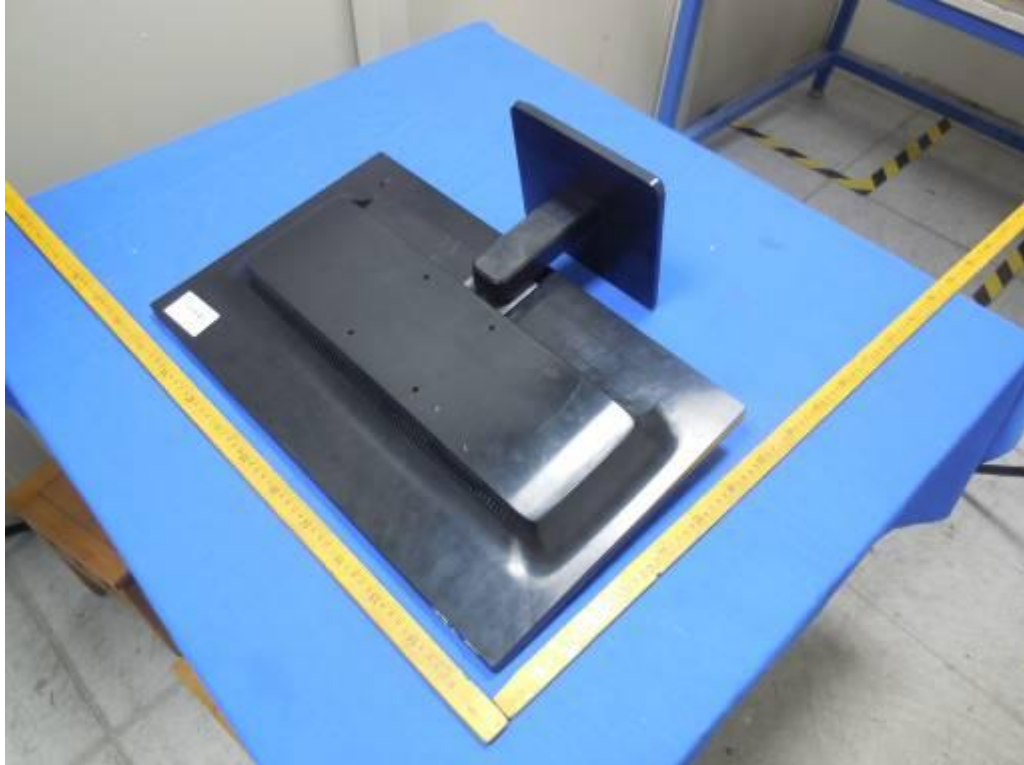

2) EUT Photo





Original:

3) EUT Photo

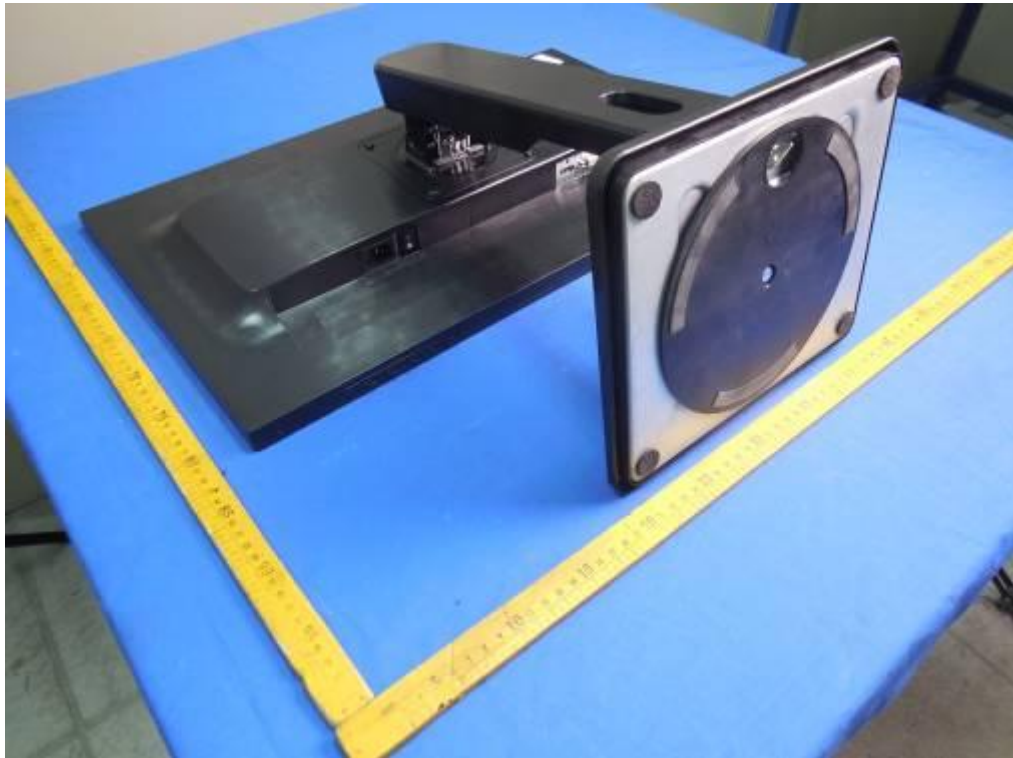

4) EUT Photo

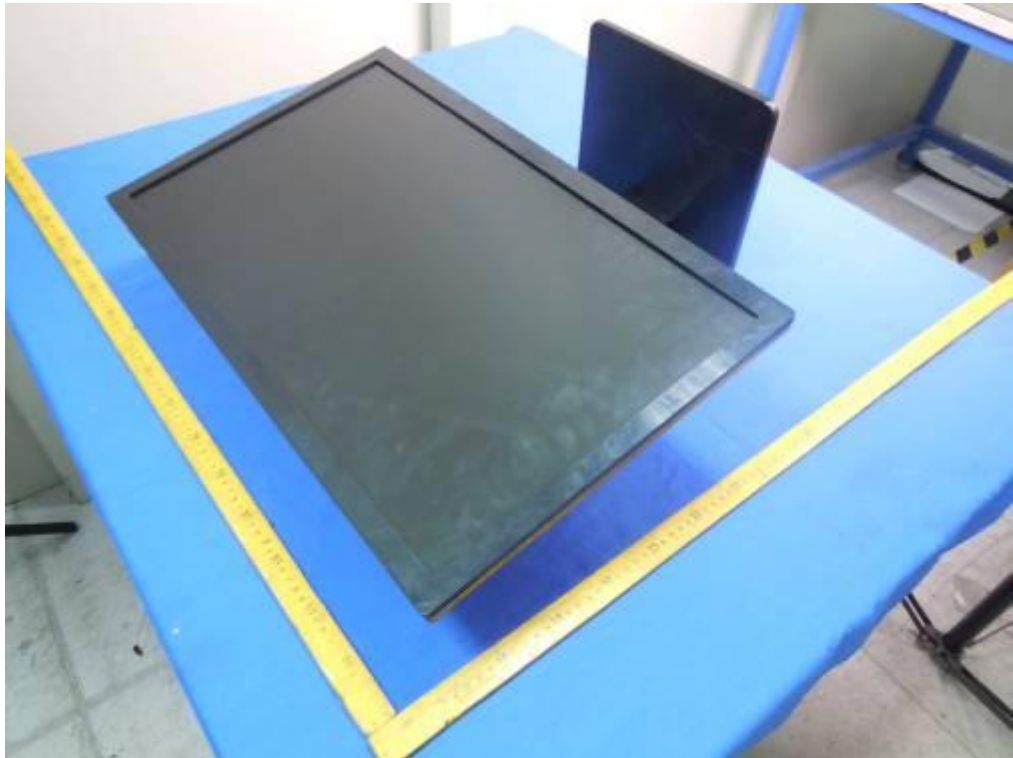



5) EUT Photo



6) EUT Photo





7) EUT Photo

