



Ref. Certif. No.

JPTUV-049586

IEC SYSTEM FOR MUTUAL RECOGNITION OF TEST CERTIFICATES FOR ELECTRICAL EQUIPMENT (IECEE) CB SCHEME

SYSTEME CEI D'ACCEPTATION MUTUELLE DE CERTIFICATS D ESSAIS DES EQUIPEMENTS ELECTRIQUES (IECEE) METHODE OC

CB TEST CERTIFICATE

CERTIFICAT D'ESSAI OC

Product
Produit

LCD MONITOR

Name and address of the applicant
Nom et adresse du demandeur

TPV Electronics (Fujian) Co., Ltd.
Yuan Hong Rd., Shang-Zheng Hong-Lu
Fuqing City Fujian 350301, P.R. China

Name and address of the manufacturer
Nom et adresse du fabricant

TPV Electronics (Fujian) Co., Ltd.
Yuan Hong Rd., Shang-Zheng Hong-Lu
Fuqing City Fujian 350301, P.R. China

Name and address of the factory
Nom et adresse de l'usine

See additional page(s)

Ratings and principal characteristics
Valeurs nominales et caractéristiques principales

AC 100-240V; 50/60Hz; 1.5A; Class I

Trademark (if any)
Marque de fabrique (si elle existe)

AOC

Type of Manufacturer's Testing Laboratories used
Type de programme du laboratoire d'essais constructeur

N/A

Model / Type Ref.
Ref. de type

185LM000**, *970SW****, 215LM000**, *2270SW****
(* = 0-9, A-Z, a-z, -, \, /, + or blank)

Additional information (if necessary may also be reported on page 2)
Les informations complémentaires (si nécessaire, peuvent être indiqués sur la 2^{ème} page)

For model differences, refer to the test report.

A sample of the product was tested and found to be in conformity with
Un échantillon de ce produit a été essayé et a été considéré conforme à la

IEC 60950-1:2005 + A1
National differences see test report

As shown in the Test Report Ref. No. which forms part of this Certificate
Comme indiqué dans le Rapport d'essais numéro de référence qui constitue partie de ce Certificat

17028284 001

This CB Test Certificate is issued by the National Certification Body
Ce Certificat d'essai OC est établi par l'Organisme National de Certification



TÜV Rheinland Japan Ltd.
Global Technology Assessment Center
4-25-2 Kita-Yamata, Tsuzuki-ku
Yokohama 224-0021 Japan
Phone + 81 45 914-3888
Fax + 81 45 914-3354
Mail: info@jpn.tuv.com
Web: www.tuv.com

Date: 05.02.2013

Signature: Ing. M. Eichenseder

1. TPV Technology (Beijing) Co., Ltd.
No. 10, Jiu Xian Qiao Rd.
Chao Yang District, Beijing 100016
P.R. China
2. Tatung Mexico S.A. de C.V.
Ave. Rosa Ma. Fuentes #7050
Complejo Industrial Fuentes
C.P. 32320, Cd. Juarez. Chih,
MEXICO
3. TPV Display Technology (Wuhan)
Co., Ltd.
Unique No. 11, Zhuankou Development
District of Economic Technological
Development Zone, Wuhan City 430056, P.R. China
4. TPV Electronics (Fujian) Co., Ltd.
Yuan Hong Rd., Shang-Zheng Hong-Lu
Fuqing City Fujian 350301
P.R. China
5. Envision Industry of Electronic
Products Ltd.
895, Joao Marcos Pozzetti Street,
Industrial District II,
69.075-215 Manaus, Am, Brazil
6. Tatung Czech s.r.o
U Nove Hospody 4
30100 Plzen
Czech Republic
7. Envision Industry of Electronic
Products Ltd.
Rodovia Anhanguera S/N-KM 49
13.205-700 Tijuco Preto-Jundiaí-SP-
Brazil
8. TPV Displays Polska Sp. z o.o.
ul. Zlotego Smoka 9
66-400 Gorzów Wlkp.
Poland
9. L&T Display Technology (Fujian) Ltd.
Optoelectronic Park, Rongqiao
Economic and Technological
Development Zone
Fuqing, Fujian 350301, P.R. China

Additional information (if necessary)
Information complémentaire (si nécessaire)

Report Ref. No.: 17028284 001

Date: 05.02.2013

Signature:  Ing. M. Eichenseder

10. TPV Display Technology (Beihai)
Co., Ltd.
China Electronic Beihai Industry
Park, Northeast of the Crossing
Between Taiwan Road and Jilin Road, Beihai City, Guangxi, P.R. China
11. Envision Industry of Electronic
Products Ltd.
Av Torquato Tapajós 7503,
Galpão : II Bloco: B-Condomínio
de Galpões-Tarumã-Manaus, AM, Brazil
12. TPV Technology (Qingdao)
Co., Ltd.
No.99 Huoju Road, High-tech Industrial
Development Zone
Qingdao City, Shandong Province, P.R. China

Additional information (if necessary)
Information complémentaire (si nécessaire)

Report Ref. No.: 17028284 001

Date: 05.02.2013

Signature:

Ing. M. Eichenseder



Test Report issued under the responsibility of:



TEST REPORT	
IEC 60950-1	
Information technology equipment – Safety – Part 1: General requirements	
Report Number	17028284 001
Date of issue	31.Jan.2013
Total number of pages	59 pages
CB Testing Laboratory	TÜV Rheinland (Shenzhen) Co., Ltd.
Address	3 & 4 F, Cybio Technology Building No. 1, Langshan No. 2 Road South, 5th Industrial Area, High-Tech Industry Park North, Nanshan District, 518057, Shenzhen, P.R. China
Applicant's name	TPV Electronics (Fujian) Co., Ltd.
Address	Yuan Hong Rd., Shang-Zheng Hong-Lu, Fuqing City Fujian 350301 P.R. China
Manufacturer's name	Same as applicant
Address	Same as applicant
Test specification:	
Standard	IEC 60950-1:2005 (Second Edition); Am 1:2009
Test procedure	CB Scheme
Non-standard test method	N/A
Test Report Form No	IEC60950_1C
Test Report Form(s) Originator	SGS Fimko Ltd
Master TRF	Dated 2012-08
Copyright © 2012 Worldwide System for Conformity Testing and Certification of Electrotechnical Equipment and Components (IECEE), Geneva, Switzerland. All rights reserved.	
This publication may be reproduced in whole or in part for non-commercial purposes as long as the IECEE is acknowledged as copyright owner and source of the material. IECEE takes no responsibility for and will not assume liability for damages resulting from the reader's interpretation of the reproduced material due to its placement and context.	
If this Test Report Form is used by non-IECEE members, the IECEE/IEC logo and the reference to the CB Scheme procedure shall be removed.	
This report is not valid as a CB Test Report unless signed by an approved CB Testing Laboratory and appended to a CB Test Certificate issued by an NCB in accordance with IECEE 02.	
Test item description	LCD MONITOR
Trade Mark	AOC
Manufacturer	See above
Model/Type reference	185LM000**, *970SW****, 215LM000**, *2270SW**** (* can be 0-9, A-Z, a-z, -, \, /, + or blank for marketing purpose)

Ratings.....: I/P: 100-240Vac, 50/60Hz, 1.5A

Testing procedure and testing location:		
<input checked="" type="checkbox"/>	CB Testing Laboratory:	TÜV Rheinland (Shenzhen) Co., Ltd.
Testing location/ address.....:		3 & 4 F, Cybio Technology Building No. 1, Langshan No. 2 Road South, 5th Industrial Area, High-Tech Industry Park North, Nanshan District, 518057, Shenzhen, P.R. China
<input type="checkbox"/>	Associated CB Laboratory:	N/A
Testing location/ address.....:		N/A
Tested by (name + signature).....:		Steven Lin
Approved by (name + signature).....:		Aegean Li
<input type="checkbox"/>	Testing procedure: TWP	N/A
Testing location/ address.....:		N/A
Tested by (name + signature).....:		
Approved by (name + signature).....:		
<input type="checkbox"/>	Testing procedure: WWT	N/A
Testing location/ address.....:		N/A
Tested by (name + signature).....:		
Witnessed by (name + signature).....:		
Approved by (name + signature).....:		
<input type="checkbox"/>	Testing procedure: SMT	N/A
Testing location/ address.....:		N/A
Tested by (name + signature).....:		
Approved by (name + signature).....:		
Supervised by (name + signature).....:		
<input type="checkbox"/>	Testing procedure: RMT	N/A
Testing location/ address.....:		N/A
Tested by (name + signature).....:		
Approved by (name + signature).....:		
Supervised by (name + signature).....:		

List of Attachments (including a total number of pages in each attachment):

- Photo documentation (9 pages)
- National Differences (59 pages)

Summary of testing:**Tests performed (name of test and test clause):**

The tests were carried out under the most unfavorable combination within the manufacturer's operating specifications of the following parameters:

- supply voltage, which ranged from 100-240Vac
- operating temperature, Max. ambient temperature 40 °C declared by the client
- operating mode: continuous
- operating load:
maximum brightness, maximum contrast, full white screen.

The critical tests were performed for this equipment included clauses 1.6.2, 1.7.11, 2.1.1.1, 2.1.1.5, 2.1.1.7, 2.2.2, 2.2.3, 2.5*, 2.6.3.4, 2.9.2, 2.10.2, 2.10.3, 2.10.4, 4.1, 4.2.2, 4.2.3, 4.2.4, 4.2.5, 4.2.7, 4.2.10, 4.5.2, 4.5.5, 4.6, 5.1.6, 5.2 and 5.3 in scope of this standard, for temperature test the thermocouples method used, regarding fault condition test simulated faults applied.

The EUT passed the test.

*** Note:**

Output DC voltages +15V and +5V of switching power supply board type 715G5527, +15V is supplied for DC/DC converter, +5V is supplied for main board.
LPS applied for +15V and +5V outputs on power supply board.

Testing location:

All tests as described in Test Case and Measurement Sections were performed at the laboratory described on page 2

Summary of compliance with National Differences

List of countries addressed:

EU Group Differences, EU Special National Conditions, EU A-Deviations, AT, AU*, BE, CA, CH, CN, CZ, DE, DK, FI, FR, GB, GR, HU, IT, IL, JP#, KR, NL, NO, PL, SE, SI, SK, US

Explanation of used codes: AT=Austria, AU=Australia, BE=Belgium, CA=Canada, CH=Switzerland, CN=China, CZ=Czech Republic, DE=Germany, DK=Denmark, FI=Finland, FR=France, GB=United Kingdom, GR=Greece, HU=Hungary, IT=Italy, IL=Israel, JP=Japan, KR=Korea, NL=The Netherlands, NO=Norway, PL=Poland, SE=Sweden, SI=Slovenia, SK=Slovakia, US=United States of America

For National Differences see end of this test report.

* National differences to IEC 60950-1:2005 evaluated.

National differences to IEC 60950-1:2001 evaluated.

Japan deviations J60950-1 (H22) and J3000 (H21) both covered.

The product fulfils the requirements of EN 60950-1: 2006 + A11:2009 + A1:2010 + A12:2011.

Copy of marking plate

AOC LCD MONITOR/液晶显示器/液晶顯示器/모니터(LED Backlight)

Product Name/Name Produk/機種名/機種名/모델명: E970SWN
 Model No. 型号/型號/모델명: 185LM00019
 Power Rating/Tegangan/额定电源/额定電源/정격전력: 100-240V~50/60Hz 1.5A(1.5A)
 제조업체명: TPV DisplayTechnology(Wuhan) Co, Ltd
 Unique No. 11 Zhuankou Development District of Economic Technological Development Zone Wuhan City, P. R. China
 Peringatan: Bahaya Kejutan Listrik, Jangan Dibuka
 Warning: Shock Hazard, Do Not Open.
 Made in China/ Buatan China
 제조국: 중국/中国製造/中國製造

This device complies with Part 15 of the FCC rules. Operation is subject to the following two conditions: (1) this device may not cause harmful interference and (2) this device must accept any interference received, including interference that may cause undesired operation.

This Class B digital apparatus complies with Canadian ICES-003
 Cet appareil numérique de la classe B est conforme à la norme NMB-003 du Canada.

高压注意: 非专业维修人员请勿打开后盖。
 高压注意: 非專業維修人員請勿打開後蓋。

BARCODE CODE
54X14mm

H40G020N-815-53A XX R33037 ENERGY STAR TÜV Rheinland CCC FCC CCC 显示器合格证

AOC LCD MONITOR/液晶显示器/液晶顯示器/모니터(LED Backlight)

Product Name/Name Produk/機種名/機種名/모델명: E2270SWN
 Model No. 型号/型號/모델명: 215LM00041
 Power Rating/Tegangan/额定电源/额定電源/정격전력: 100-240V~50/60Hz 1.5A(1.5A)
 제조업체명: TPV DisplayTechnology(Wuhan) Co, Ltd
 Unique No. 11 Zhuankou Development District of Economic Technological Development Zone Wuhan City, P. R. China
 Peringatan: Bahaya Kejutan Listrik, Jangan Dibuka
 Warning: Shock Hazard, Do Not Open.
 Made in China/ Buatan China
 제조국: 중국/中国製造/中國製造

This device complies with Part 15 of the FCC rules. Operation is subject to the following two conditions: (1) this device may not cause harmful interference and (2) this device must accept any interference received, including interference that may cause undesired operation.

This Class B digital apparatus complies with Canadian ICES-003
 Cet appareil numérique de la classe B est conforme à la norme NMB-003 du Canada.

高压注意: 非专业维修人员请勿打开后盖。
 高压注意: 非專業維修人員請勿打開後蓋。

BARCODE CODE
54X14mm

H40G020N-815-53A XX R33037 ENERGY STAR TÜV Rheinland CCC FCC CCC 显示器合格证

Note: The above label is a draft of an artwork of marking plate pending approval by National Certification Bodies and it shall not be affixed to products prior to such an approval.

Test item particulars:	
Equipment mobility.....:	<input checked="" type="checkbox"/> movable (for unit with base stand) <input type="checkbox"/> hand-held <input type="checkbox"/> transportable <input checked="" type="checkbox"/> stationary (for unit without base stand) <input type="checkbox"/> for building-in <input type="checkbox"/> direct plug-in
Connection to the mains	<input checked="" type="checkbox"/> pluggable equipment <input checked="" type="checkbox"/> type A <input type="checkbox"/> type B <input type="checkbox"/> permanent connection <input checked="" type="checkbox"/> detachable power supply cord <input type="checkbox"/> non-detachable power supply cord <input type="checkbox"/> not directly connected to the mains
Operating condition.....:	<input checked="" type="checkbox"/> continuous <input type="checkbox"/> rated operating / resting time:
Access location	<input checked="" type="checkbox"/> operator accessible <input type="checkbox"/> restricted access location
Over voltage category (OVC)	<input type="checkbox"/> OVC I <input checked="" type="checkbox"/> OVC II <input type="checkbox"/> OVC III <input type="checkbox"/> OVC IV <input type="checkbox"/> other:
Mains supply tolerance (%) or absolute mains supply values	±10% (requested by client)
Tested for IT power systems	<input type="checkbox"/> Yes (only for Norway) <input checked="" type="checkbox"/> No
IT testing, phase-phase voltage (V)	N/A
Class of equipment	<input checked="" type="checkbox"/> Class I <input type="checkbox"/> Class II <input type="checkbox"/> Class III <input type="checkbox"/> Not classified
Considered current rating of protective device as part of the building installation (A)	16A
Pollution degree (PD)	<input type="checkbox"/> PD 1 <input checked="" type="checkbox"/> PD 2 <input type="checkbox"/> PD 3
IP protection class	IP20
Altitude during operation (m)	≤5000
Altitude of test laboratory (m)	<2000
Mass of equipment (kg)	18.5" model: approx. 1.95kg with base (base weight: 0.19kg); 21.5" model: approx. 2.46kg with base (base weight: 0.22kg)
Possible test case verdicts:	
- test case does not apply to the test object	: N/A
- test object does meet the requirement.....	: P (Pass)
- test object does not meet the requirement.....	: F (Fail)
Testing:	
Date of receipt of test item	: Jan.2013
Date(s) of performance of tests.....	: Jan.2013
General remarks:	
The test results presented in this report relate only to the object tested. This report shall not be reproduced, except in full, without the written approval of the Issuing testing laboratory. "(see Enclosure #)" refers to additional information appended to the report. "(see appended table)" refers to a table appended to the report.	
Throughout this report a <input type="checkbox"/> comma / <input checked="" type="checkbox"/> point is used as the decimal separator.	

Manufacturer's Declaration per sub-clause 6.2.5 of IECEE 02:

The application for obtaining a CB Test Certificate includes more than one factory location and a declaration from the Manufacturer stating that the sample(s) submitted for evaluation is (are) representative of the products from each factory has been provided: Yes Not applicable

When differences exist; they shall be identified in the General product information section.

Name and address of factory (ies)..... :

- 1 TPV Technology (Beijing) Co., Ltd.
No.10, Jiu Xian Qiao Rd., Chao Yang District,
Beijing 100016 P.R. China
- 2 Tatung Mexico S.A. de C.V.
Ave. Rosa Ma. Fuentes #7050 Complejo
Industrial Fuentes C.P. 32320, Cd. Juarez.
Chih, MEXICO
- 3 TPV Display Technology (Wuhan) Co., Ltd.
Unique No. 11, Zhuankou Development District
of Economic Technological Development Zone,
Wuhan City 430056, P.R. China
- 4 TPV Electronics (Fujian) Co., Ltd.
Yuan Hong Rd., Shang-Zheng Hong-Lu
Fuqing City Fujian 350301 P.R. China
- 5 Envision Industry of Electronic Products Ltd.
895, Joao Marcos Pozzetti Street, Industrial
District II, 69.075-215 Manaus, Am, Brazil
- 6 Tatung Czech s.r.o.
U Nove Hospody 4 30100 Plzen Czech
Republic
- 7 Envision Industry of Electronic Products Ltd.
Rodovia Anhanguera S/N-KM 49, 13.205-700
Tijuco Preto-Jundiaí-SP-Brazil
- 8 TPV Displays Polska Sp. z o.o.
ul. Zlotego Smoka 9 66-400 Gorzów Wlkp.
Poland
- 9 L&T Display Technology (Fujian) Ltd.
Optoelectronic Park, Rongqiao Economic and
Technological, Development Zone, Fuqing,
Fujian 350301, P.R. China
- 10 TPV Display Technology (Beihai) Co., Ltd.
China Electronic Beihai Industry Park,
Northeast of the Crossing Between Taiwan
Road and Jilin Road, Beihai City, Guangxi,
P.R. China
- 11 Envision Industry of Electronic Products Ltd.
Av Torquato Tapajós 7503, Galpão : II Bloco:
B – Condomínio de Galpões – Tarumã -
Manaus, AM, Brazil
- 12 TPV Technology (Qingdao) Co., Ltd.
No.99 Huoju Road, High-tech Industrial
Development Zone, Qingdao City, Shandong
Province, P.R. China
- 13 TPV Display Technology (China) Co., Ltd.
No.106 Jinghai 3 Rd., BDA, Beijing City
100176, P.R. China.

General product information:

The models 185LM000**, *970SW****, 215LM000**, *2270SW**** are LCD monitor intended for general office use. Model *970SW**** is identical to model 185LM000** except for type designation, and model *2270SW**** is identical to model 215LM000** except for type designation.

Model 185LM000** has following features:

1. LCD Type: 18.5" TFT LCD with LED backlight (resolution: 1366 x 768);
2. Building-in power supply board 715G5527 with DC/DC converter;
3. Main board 715G5965 with VGA port;
4. The internal metal chassis is considered as fire enclosure and mechanical enclosure, and the external plastic enclosure is regarded as electrical enclosure and mechanical enclosure, made of min. HB material;
5. Maximum declared ambient: 40°C.

Model 215LM000** is identical to model 185LM000** except for:

1. LCD Type: 21.5" TFT LCD with LED backlight (resolution: 1920 x 1080);
2. New main board 715G5846 with VGA port used only;
3. Bigger size of external plastic enclosure used;
4. Bigger size of base stand used.

Definition of variable(s):

Variable:	Range of variable:	Content:
*	0-9, A-Z, a-z, -, \, /, + or blank	for marketing purpose

Abbreviations used in the report:

- normal conditions	N.C.	- single fault conditions	S.F.C
- functional insulation	OP	- basic insulation	BI
- double insulation	DI	- supplementary insulation	SI
- between parts of opposite polarity	BOP	- reinforced insulation	RI

Indicate used abbreviations (if any)

IEC 60950-1			
Clause	Requirement + Test	Result - Remark	Verdict
1	GENERAL		P
1.5	Components		P
1.5.1	General		P
	Comply with IEC 60950 or relevant component standard	(see appended table 1.5.1)	P
1.5.2	Evaluation and testing of components	Components which are certified to IEC and/or national standards are used correctly within their ratings. Components not covered by IEC standards are tested under the conditions present in the equipment.	P
1.5.3	Thermal controls	No thermal controls.	N/A
1.5.4	Transformers	Transformers used are suitable for their intended application and comply with the relevant requirements of the standard and particularly Annex C.	P
1.5.5	Interconnecting cables	Interconnecting cable does not carry voltage higher than SELV and no higher energy level than 240VA.	P
1.5.6	Capacitors bridging insulation	Between lines: one X1 or X2 capacitor (C904) according to IEC 60384-14 was used. Between primary and earth: three Y1 or Y2 capacitors (C900, C902 and C903) according to IEC 60384-14 were used.	P
1.5.7	Resistors bridging insulation		P
1.5.7.1	Resistors bridging functional, basic or supplementary insulation	Only resistors R900, R901, R902 bridging between L-N (functional)	P
1.5.7.2	Resistors bridging double or reinforced insulation between a.c. mains and other circuits		N/A
1.5.7.3	Resistors bridging double or reinforced insulation between a.c. mains and antenna or coaxial cable		N/A
1.5.8	Components in equipment for IT power systems		N/A
1.5.9	Surge suppressors	No surge suppressors.	N/A
1.5.9.1	General		N/A
1.5.9.2	Protection of VDRs		N/A

IEC 60950-1			
Clause	Requirement + Test	Result - Remark	Verdict
1.5.9.3	Bridging of functional insulation by a VDR	No such component.	N/A
1.5.9.4	Bridging of basic insulation by a VDR		N/A
1.5.9.5	Bridging of supplementary, double or reinforced insulation by a VDR		N/A

1.6	Power interface		P
1.6.1	AC power distribution systems	TN power system	P
1.6.2	Input current	(see appended table 1.6.2)	P
1.6.3	Voltage limit of hand-held equipment	This appliance is not hand-held equipment.	N/A
1.6.4	Neutral conductor	The neutral conductor insulated from earth and from the body throughout the equipment as if it were a line conductor	P

1.7	Marking and instructions		P
1.7.1	Power rating and identification markings	See below.	P
1.7.1.1	Power rating marking	See below.	P
	Multiple mains supply connections.....:		N/A
	Rated voltage(s) or voltage range(s) (V)	See copy of marking plate for details	P
	Symbol for nature of supply, for d.c. only..... :	AC source	N/A
	Rated frequency or rated frequency range (Hz) ... :	See copy of marking plate for details	P
	Rated current (mA or A)	See copy of marking plate for details	P
1.7.1.2	Identification markings	See below.	P
	Manufacturer's name or trade-mark or identification mark	See copy of marking plate for details	P
	Model identification or type reference	See copy of marking plate for details	P
	Symbol for Class II equipment only	Class I equipment.	N/A
	Other markings and symbols	Additional symbol or marking does not give rise to misunderstanding.	P
1.7.2	Safety instructions and marking	English safety instruction provided.	P
1.7.2.1	General		P

IEC 60950-1			
Clause	Requirement + Test	Result - Remark	Verdict
1.7.2.2	Disconnect devices	AC inlet serves as disconnect device.	P
1.7.2.3	Overcurrent protective device	Not type B pluggable equipment or permanently connected equipment.	N/A
1.7.2.4	IT power distribution systems	TN power system.	N/A
1.7.2.5	Operator access with a tool	No such access required.	N/A
1.7.2.6	Ozone	Ozone not used or generated.	N/A
1.7.3	Short duty cycles	Equipment is designed for continuous operation.	N/A
1.7.4	Supply voltage adjustment	Single input voltage range without adjustment.	N/A
	Methods and means of adjustment; reference to installation instructions		N/A
1.7.5	Power outlets on the equipment	No power outlets provided.	N/A
1.7.6	Fuse identification (marking, special fusing characteristics, cross-reference)	The fuse marking is marked near fuse on PCB as follow: F901(on primary): T3.15AL/250Vac CAUTION: FOR CONTINUED PROTECTION AGAINST RISK OF FIRE, REPLACE ONLY WITH SAME TYPE AND RATING OF FUSE. F902(on secondary)(optional): T5AL/250Vac Not located in operator access areas.	P
1.7.7	Wiring terminals	See below.	P
1.7.7.1	Protective earthing and bonding terminals	AC inlet used. Symbol marked beside earthing pin of AC inlet	P
1.7.7.2	Terminals for a.c. mains supply conductors	The equipment is not permanently connected or provided with a non-detachable power supply cord	N/A
1.7.7.3	Terminals for d.c. mains supply conductors	Not connected to d.c. mains	N/A
1.7.8	Controls and indicators	See below	P
1.7.8.1	Identification, location and marking	“STAND-BY” condition is indicated by the symbol according to 60417-1-IEC-5009.	P
1.7.8.2	Colours	Colours used for LED indicate the operation status and not involved safety.	N/A

IEC 60950-1			
Clause	Requirement + Test	Result - Remark	Verdict
1.7.8.3	Symbols according to IEC 60417..... :	See 1.7.8.1	P
1.7.8.4	Markings using figures :	No figures used.	N/A
1.7.9	Isolation of multiple power sources :	Only one supply voltage range provided.	N/A
1.7.10	Thermostats and other regulating devices :	No such components.	N/A
1.7.11	Durability	The label was subjected to the permanence of marking test. The label was rubbed with cloth soaked with water for 15 sec. and then again for 15 sec. with the cloth soaked with petroleum spirit. After this test there was no damage to the label. The marking on the label did not fade. There was no curling or lifting of the label edge.	P
1.7.12	Removable parts	None.	N/A
1.7.13	Replaceable batteries :	No batteries.	N/A
	Language(s) :		—
1.7.14	Equipment for restricted access locations :	Equipment not intended for installation in restricted access locations.	N/A

2	PROTECTION FROM HAZARDS		P
2.1	Protection from electric shock and energy hazards		P
2.1.1	Protection in operator access areas	Only SELV signal interface accessible by operator.	P
2.1.1.1	Access to energized parts	See below	P
	Test by inspection :	Protection established by plastic enclosure.	P
	Test with test finger (Figure 2A) :	Protection established by plastic enclosure.	P
	Test with test pin (Figure 2B) :	No access to any energized parts with the removable stand detached.	P
	Test with test probe (Figure 2C) :		N/A
2.1.1.2	Battery compartments	No battery compartment.	N/A
2.1.1.3	Access to ELV wiring	No ELV wiring in operator accessible area.	N/A
	Working voltage (V_{peak} or V_{rms}); minimum distance through insulation (mm)	(see appended table 2.10.5)	—

IEC 60950-1			
Clause	Requirement + Test	Result - Remark	Verdict
2.1.1.4	Access to hazardous voltage circuit wiring	No hazardous voltage wiring in operator accessible area.	N/A
2.1.1.5	Energy hazards	The energy does not exceed 240VA between any two points in accessible connector of secondary circuit. (see appended table 2.1.1.5.)	P
2.1.1.6	Manual controls	No manual controls.	N/A
2.1.1.7	Discharge of capacitors in equipment	Max. total capacitance of X-capacitor is 0.22 μ F.	P
	Measured voltage (V); time-constant (s).....	(See appended table 2.1.1.7)	—
2.1.1.8	Energy hazards – d.c. mains supply	a.c. mains supply	N/A
	a) Capacitor connected to the d.c. mains supply ..		N/A
	b) Internal battery connected to the d.c. mains supply		N/A
2.1.1.9	Audio amplifiers		N/A
2.1.2	Protection in service access areas	No service access area.	N/A
2.1.3	Protection in restricted access locations	Equipment not intended for installation in restricted access locations	N/A

2.2	SELV circuits		P
2.2.1	General requirements	The secondary circuits were tested as SELV. See sub-clauses 2.2.1 to 2.2.4.	P
2.2.2	Voltages under normal conditions (V)	42.4V peak or 60V d.c. are not exceeded in SELV circuit under normal operation.	P
2.2.3	Voltages under fault conditions (V)	Single fault did not cause excessive voltage in accessible SELV circuits. Limits of 71V peak and 120V d.c. were not exceeded within 0.2 sec. and limits 42.4V peak and 60V d.c. were not exceeded for longer than 0.2 sec., see appended tables 2.2.3 and 5.3.	P
2.2.4	Connection of SELV circuits to other circuits	See sub-clauses 2.2.2 and 2.2.3. No direct connection between SELV and any primary circuits.	P

IEC 60950-1			
Clause	Requirement + Test	Result - Remark	Verdict
2.3	TNV circuits		N/A
2.3.1	Limits		N/A
	Type of TNV circuits..... :		—
2.3.2	Separation from other circuits and from accessible parts		N/A
2.3.2.1	General requirements		N/A
2.3.2.2	Protection by basic insulation		N/A
2.3.2.3	Protection by earthing		N/A
2.3.2.4	Protection by other constructions :		N/A
2.3.3	Separation from hazardous voltages		N/A
	Insulation employed :		—
2.3.4	Connection of TNV circuits to other circuits		N/A
	Insulation employed :		—
2.3.5	Test for operating voltages generated externally		N/A
2.4	Limited current circuits		P
2.4.1	General requirements	Primary and secondary circuits bridged by Y1 type capacitor C900. The pin connected with secondary circuits was disconnected and a non-inductive resistor of 2000 was connected between this pin and neutral during the test.	P
2.4.2	Limit values	(see appended table 2.4.2)	P
	Frequency (H2)..... :		—
	Measured current (mA)..... :		—
	Measured voltage (V)..... :		—
	Measured circuit capacitance (nF or μ F) :		—
2.4.3	Connection of limited current circuits to other circuits	Only intended to be connected with SELV circuits.	P
2.5	Limited power sources		P
	a) Inherently limited output		N/A
	b) Impedance limited output		N/A

IEC 60950-1			
Clause	Requirement + Test	Result - Remark	Verdict
	c) Regulating network limited output under normal operating and single fault condition	Regulating network limits the outputs of +5V and +15V in compliance with table 2B, both with and without a simulated single fault in the regulating network.	P
	d) Overcurrent protective device limited output		N/A
	Max. output voltage (V), max. output current (A), max. apparent power (VA)	(see appended table 2.5)	—
	Current rating of overcurrent protective device (A)	(see appended table 2.5)	—
	Use of integrated circuit (IC) current limiters		

2.6	Provisions for earthing and bonding		P
2.6.1	Protective earthing	Class I appliance inlet terminal provided as protective earthing terminal, and accessible metal plate is connected to earthed metal fire enclosure. The test of 2.6.3.4 complied.	P
2.6.2	Functional earthing	Functional earthing in the secondary circuit is accessible at the VGA connector and separated from the primary by reinforced insulation.	P
2.6.3	Protective earthing and protective bonding conductors		P
2.6.3.1	General	Appliance inlet used. No power cord provided with the unit.	P
2.6.3.2	Size of protective earthing conductors	AC inlet used	N/A
	Rated current (A), cross-sectional area (mm ²), AWG		—
2.6.3.3	Size of protective bonding conductors	Screws fixing earthed PCB trace to metal chassis for protective bonding.	P
	Rated current (A), cross-sectional area (mm ²), AWG	Refer to test of appended table 2.6.3.4 only.	—
	Protective current rating (A), cross-sectional area (mm ²), AWG	Refer to test of appended table 2.6.3.4 only.	
2.6.3.4	Resistance of earthing conductors and their terminations; resistance (Ω), voltage drop (V), test current (A), duration (min)	(see appended table 2.6.3.4)	P
2.6.3.5	Colour of insulation	Protective bonding conductor as in 2.6.3 and assembled by printed wiring on power board.	N/A

IEC 60950-1			
Clause	Requirement + Test	Result - Remark	Verdict
2.6.4	Terminals	See below	P
2.6.4.1	General		P
2.6.4.2	Protective earthing and bonding terminals	The earth terminal of the approved appliance inlet is considered as protective earthing terminal and was evaluated by sub clause 2.6.3.4.	P
	Rated current (A), type, nominal thread diameter (mm)..... :	Evaluation by test. See sub-clause 2.6.3.4.	—
2.6.4.3	Separation of the protective earthing conductor from protective bonding conductors	Separated PE and protective bonding conductor used.	P
2.6.5	Integrity of protective earthing	See below	P
2.6.5.1	Interconnection of equipment	Not depending on interconnection for protective earthing.	P
2.6.5.2	Components in protective earthing conductors and protective bonding conductors	No switch or overcurrent protective device in protective earthing or bonding conductor	P
2.6.5.3	Disconnection of protective earth	Appliance inlet used for disconnection of protective earth.	P
2.6.5.4	Parts that can be removed by an operator	AC inlet with PE terminal used.	P
2.6.5.5	Parts removed during servicing		N/A
2.6.5.6	Corrosion resistance	All safety earthing connections comply with Annex J.	P
2.6.5.7	Screws for protective bonding	No self-tapping or spaced thread screws are used. For the earth connection to the metal chassis a spring washer and a screw are used.	N/A
2.6.5.8	Reliance on telecommunication network or cable distribution system	No TNV circuit.	N/A
2.7	Overcurrent and earth fault protection in primary circuits		P
2.7.1	Basic requirements	The equipment relies on fuse or circuit breaker of the wall outlet protection of the building installation in regard to L to N short-circuits. A build-in fuse provided as overcurrent protection device (see 5.3)	P
	Instructions when protection relies on building installation	Pluggable equipment type A.	N/A

IEC 60950-1			
Clause	Requirement + Test	Result - Remark	Verdict
2.7.2	Faults not simulated in 5.3.7	The protection devices are well dimensioned and mounted.	P
2.7.3	Short-circuit backup protection	Building installation is considered as providing short-circuit backup protection.	P
2.7.4	Number and location of protective devices :	Overcurrent protection by one built-in fuse	P
2.7.5	Protection by several devices	Protection by one fuse only.	N/A
2.7.6	Warning to service personnel :	No service work necessary.	N/A

2.8	Safety interlocks		N/A
2.8.1	General principles		N/A
2.8.2	Protection requirements		N/A
2.8.3	Inadvertent reactivation		N/A
2.8.4	Fail-safe operation		N/A
	Protection against extreme hazard		N/A
2.8.5	Moving parts		N/A
2.8.6	Overriding		N/A
2.8.7	Switches and relays		N/A
2.8.7.1	Contact gaps (mm) :		N/A
2.8.7.2	Overload test		N/A
2.8.7.3	Endurance test		N/A
2.8.7.4	Electric strength test		N/A
2.8.8	Mechanical actuators		N/A

2.9	Electrical insulation		P
2.9.1	Properties of insulating materials	Natural rubber, asbestos or hygroscopic material not used.	P
2.9.2	Humidity conditioning	Performed at 40 °C, 95% R.H. for 120 h by client's request.	P
	Relative humidity (%), temperature (°C) :	See above.	—
2.9.3	Grade of insulation	See above.	P
2.9.4	Separation from hazardous voltages	The adequate levels of safety insulation provided and maintained to comply with the requirements of this standard.	P
	Method(s) used :	SELV separated from primary by reinforced or double insulation.	—

IEC 60950-1			
Clause	Requirement + Test	Result - Remark	Verdict
2.10	Clearances, creepage distances and distances through insulation		P
2.10.1	General	See sub-clauses 2.10.3, 2.10.4 and 2.10.5.	P
2.10.1.1	Frequency	Considered	P
2.10.1.2	Pollution degrees	2	P
2.10.1.3	Reduced values for functional insulation	Considered	P
2.10.1.4	Intervening unconnected conductive parts	Considered	P
2.10.1.5	Insulation with varying dimensions	Insulation kept homogenous.	N/A
2.10.1.6	Special separation requirements	Not applied.	N/A
2.10.1.7	Insulation in circuits generating starting pulses	No such circuits.	N/A
2.10.2	Determination of working voltage		P
2.10.2.1	General	The rms and the peak voltage were measured with unit connected to a 240V TN power system. The input neutral and secondary ground were connected during measurement. Pollution Degree 2 and Overvoltage Category II considered.	P
2.10.2.2	RMS working voltage	See table 2.10.2	P
2.10.2.3	Peak working voltage	See table 2.10.2	P
2.10.3	Clearances	See below and advantage of annex G is not considered.	P
2.10.3.1	General	Considered.	P
2.10.3.2	Mains transient voltages		P
	a) AC mains supply	240V a.c. and Overvoltage Category II	P
	b) Earthed d.c. mains supplies		N/A
	c) Unearthed d.c. mains supplies		N/A
	d) Battery operation		N/A
2.10.3.3	Clearances in primary circuits	(see appended table 2.10.3 and 2.10.4)	P
2.10.3.4	Clearances in secondary circuits	Sub-clause 5.3.4 considered.	P
2.10.3.5	Clearances in circuits having starting pulses		N/A
2.10.3.6	Transients from a.c. mains supply	Normal transient voltage considered (overvoltage category II for primary circuit).	N/A
2.10.3.7	Transients from d.c. mains supply		N/A
2.10.3.8	Transients from telecommunication networks and cable distribution systems		N/A

IEC 60950-1			
Clause	Requirement + Test	Result - Remark	Verdict
2.10.3.9	Measurement of transient voltage levels		N/A
	a) Transients from a mains supply		N/A
	For an a.c. mains supply		N/A
	For a d.c. mains supply		N/A
	b) Transients from a telecommunication network :		N/A
2.10.4	Creepage distances		P
2.10.4.1	General		P
2.10.4.2	Material group and comparative tracking index		P
	CTI tests	Material group IIIb is assumed to be used.	—
2.10.4.3	Minimum creepage distances	(see appended table 2.10.3 and 2.10.4)	P
2.10.5	Solid insulation		P
2.10.5.1	General		P
2.10.5.2	Distances through insulation	(see appended table 2.10.5)	P
2.10.5.3	Insulating compound as solid insulation	Only inside approved optocoupler.	N/A
2.10.5.4	Semiconductor devices	Approved optocoupler complies to IEC 60747-5-2 and having dti. 0.4mm.	P
2.10.5.5.	Cemented joints	Not applied.	N/A
2.10.5.6	Thin sheet material – General		P
2.10.5.7	Separable thin sheet material	Used in transformer.	P
	Number of layers (pcs)	3 layers for reinforced insulation.	—
2.10.5.8	Non-separable thin sheet material	Not applied for.	N/A
2.10.5.9	Thin sheet material – standard test procedure		N/A
	Electric strength test		—
2.10.5.10	Thin sheet material – alternative test procedure		P
	Electric strength test	(see appended table 5.2)	—
2.10.5.11	Insulation in wound components	See only 2.10.5.6.	P
2.10.5.12	Wire in wound components		N/A
	Working voltage		N/A
	a) Basic insulation not under stress		N/A
	b) Basic, supplementary, reinforced insulation		N/A
	c) Compliance with Annex U		N/A
	Two wires in contact inside wound component; angle between 45° and 90°		N/A

IEC 60950-1			
Clause	Requirement + Test	Result - Remark	Verdict
2.10.5.13	Wire with solvent-based enamel in wound components	Not applied.	N/A
	Electric strength test		—
	Routine test		N/A
2.10.5.14	Additional insulation in wound components	Not applied.	N/A
	Working voltage		N/A
	- Basic insulation not under stress		N/A
	- Supplementary, reinforced insulation		N/A
2.10.6	Construction of printed boards		P
2.10.6.1	Uncoated printed boards	(see appended table 2.10.3 and 2.10.4)	P
2.10.6.2	Coated printed boards	Not applied.	N/A
2.10.6.3	Insulation between conductors on the same inner surface of a printed board	Not multi-layer printed board.	N/A
2.10.6.4	Insulation between conductors on different layers of a printed board	See above.	N/A
	Distance through insulation		N/A
	Number of insulation layers (pcs)..... :		N/A
2.10.7	Component external terminations	Coatings not used over terminations to increase effective clearance and creepage distance.	N/A
2.10.8	Tests on coated printed boards and coated components		N/A
2.10.8.1	Sample preparation and preliminary inspection		N/A
2.10.8.2	Thermal conditioning		N/A
2.10.8.3	Electric strength test		N/A
2.10.8.4	Abrasion resistance test		N/A
2.10.9	Thermal cycling		N/A
2.10.10	Test for Pollution Degree 1 environment and insulating compound	Pollution Degree 2.	N/A
2.10.11	Tests for semiconductor devices and cemented joints	Photo couplers are approved components. No other components applied for.	N/A
2.10.12	Enclosed and sealed parts	No hermetically sealed component.	N/A
3	WIRING, CONNECTIONS AND SUPPLY		P
3.1	General		P

IEC 60950-1			
Clause	Requirement + Test	Result - Remark	Verdict
3.1.1	Current rating and overcurrent protection	All internal wires are UL approved and PVC insulated. Rated VW-1, min 80°C, 300V. Internal wiring gauge is suitable for current intended to be carried. (See appended table 4.5.1) No internal wire for primary power distribution.	P
3.1.2	Protection against mechanical damage	Wires do not touch sharp edges which could damage the insulation and cause hazard.	P
3.1.3	Securing of internal wiring	Wires with only basic insulation are routed so that they are not close to any live bare components. Wires are secured by soldering method and additionally fixed by glue or by connectors.	P
3.1.4	Insulation of conductors	The insulation of the individual conductors suitable for the application and the working voltage. For the insulation material see 3.1.1.	P
3.1.5	Beads and ceramic insulators	Not used.	N/A
3.1.6	Screws for electrical contact pressure	Only metal screw is used for electrical connection between protective earth and metal chassis, and engages more than 2 complete threads.	P
3.1.7	Insulating materials in electrical connections	The integrity of protective bonding made by screw, PCB trace and spring washer.	P
3.1.8	Self-tapping and spaced thread screws	No self-tapping or spaced thread screws are used.	N/A
3.1.9	Termination of conductors	All conductors are reliably secured.	P
	10 N pull test		P
3.1.10	Sleeving on wiring		N/A
3.2	Connection to a mains supply		P
3.2.1	Means of connection	See below.	P
3.2.1.1	Connection to an a.c. mains supply	Appliance inlet used.	P
3.2.1.2	Connection to a d.c. mains supply	Only a.c. mains supply.	N/A

IEC 60950-1			
Clause	Requirement + Test	Result - Remark	Verdict
3.2.2	Multiple supply connections	Only for one mains connection.	N/A
3.2.3	Permanently connected equipment	Unit is not a permanently connected equipment.	N/A
	Number of conductors, diameter of cable and conduits (mm)		—
3.2.4	Appliance inlets	Approved appliance inlet used.	P
3.2.5	Power supply cords	See below.	N/A
3.2.5.1	AC power supply cords	Not provided.	N/A
	Type		—
	Rated current (A), cross-sectional area (mm ²), AWG		—
3.2.5.2	DC power supply cords	Not provided.	N/A
3.2.6	Cord anchorages and strain relief	Appliance inlet used	N/A
	Mass of equipment (kg), pull (N)		—
	Longitudinal displacement (mm)		—
3.2.7	Protection against mechanical damage		N/A
3.2.8	Cord guards	No cord guards	N/A
	Diameter or minor dimension D (mm); test mass (g)		—
	Radius of curvature of cord (mm)		—
3.2.9	Supply wiring space	Not permanent connection or non-detachable power cord type.	N/A

3.3	Wiring terminals for connection of external conductors		N/A
3.3.1	Wiring terminals	AC inlet used.	N/A
3.3.2	Connection of non-detachable power supply cords		N/A
3.3.3	Screw terminals		N/A
3.3.4	Conductor sizes to be connected		N/A
	Rated current (A), cord/cable type, cross-sectional area (mm ²)		—
3.3.5	Wiring terminal sizes		N/A
	Rated current (A), type, nominal thread diameter (mm)		—
3.3.6	Wiring terminal design		N/A
3.3.7	Grouping of wiring terminals		N/A
3.3.8	Stranded wire		N/A

IEC 60950-1			
Clause	Requirement + Test	Result - Remark	Verdict
3.4	Disconnection from the mains supply		P
3.4.1	General requirement	Disconnect device provided	P
3.4.2	Disconnect devices	Appliance coupler used as disconnect device.	P
3.4.3	Permanently connected equipment	Not permanently connected equipment	N/A
3.4.4	Parts which remain energized	When AC coupler is disconnected from inlet, there are no parts remaining with hazardous voltage or energy in the equipment.	P
3.4.5	Switches in flexible cords	No such switch in flexible cords	N/A
3.4.6	Number of poles - single-phase and d.c. equipment	The appliance coupler disconnects both poles simultaneously.	P
3.4.7	Number of poles - three-phase equipment	Single-phase equipment	N/A
3.4.8	Switches as disconnect devices	No such switch	N/A
3.4.9	Plugs as disconnect devices	Plug not used	N/A
3.4.10	Interconnected equipment	Only interconnected with other unit through SELV interface.	P
3.4.11	Multiple power sources	Single power source	N/A
3.5	Interconnection of equipment		P
3.5.1	General requirements	This power supply is not considered for connection to TNV.	P
3.5.2	Types of interconnection circuits	Interconnection circuits of SELV through the connector. No ELV interconnection circuits.	P
3.5.3	ELV circuits as interconnection circuits	No ELV interconnection	N/A
3.5.4	Data ports for additional equipment	All data ports are located on the main board, which is supplied by LPS.	P
4	PHYSICAL REQUIREMENTS		P
4.1	Stability		P
	Angle of 10°	No overturn. (Test by client's request)	P
	Test force (N)	Equipment is not a floor standing unit.	N/A

IEC 60950-1			
Clause	Requirement + Test	Result - Remark	Verdict
4.2	Mechanical strength		P
4.2.1	General	See below. After tests, unit comply with 2.1.1, 2.6.1 and 2.10.	P
	Rack-mounted equipment.		N/A
4.2.2	Steady force test, 10 N	Test performed on internal components. No components located such that distances according to 2.10 can be reduced.	P
4.2.3	Steady force test, 30 N	Test performed on internal metal enclosure.	P
4.2.4	Steady force test, 250 N	Test performed on plastic enclosure.	P
4.2.5	Impact test	500g steel ball falls freely from 1.3m on top, back and bottom of plastic enclosure, no access to hazardous parts.	P
	Fall test		P
	Swing test		N/A
4.2.6	Drop test; height (mm)		N/A
4.2.7	Stress relief test	70°C, 7 hours, no deformation on all sources of plastic enclosure.	P
4.2.8	Cathode ray tubes	No CRT	N/A
	Picture tube separately certified		N/A
4.2.9	High pressure lamps	No high pressure lamps	N/A
4.2.10	Wall or ceiling mounted equipment; force (N)	An additional force 52N for 18.5" model, 66N for 21.5" model applied downwards through the centre of gravity of the equipment for 1 min after the removal of base (by client's request). After the test, the equipment was not damaged. (52N = 3 x 1.76 x 9.8N; 66N = 3 x 2.24 x 9.8N)	P

4.3	Design and construction		P
4.3.1	Edges and corners	Edges and corners of the enclosure are rounded.	P
4.3.2	Handles and manual controls; force (N)	No safety relevant handles or manual controls.	N/A
4.3.3	Adjustable controls	No such controls.	N/A

IEC 60950-1			
Clause	Requirement + Test	Result - Remark	Verdict
4.3.4	Securing of parts	All parts secured properly. Spring washer used for securing screws.	P
4.3.5	Connection by plugs and sockets		N/A
4.3.6	Direct plug-in equipment	Not such equipment.	N/A
	Torque		—
	Compliance with the relevant mains plug standard		N/A
4.3.7	Heating elements in earthed equipment	None.	N/A
4.3.8	Batteries	No batteries.	N/A
	- Overcharging of a rechargeable battery		N/A
	- Unintentional charging of a non-rechargeable battery		N/A
	- Reverse charging of a rechargeable battery		N/A
	- Excessive discharging rate for any battery		N/A
4.3.9	Oil and grease	None.	N/A
4.3.10	Dust, powders, liquids and gases	Equipment in intended use not considered to be exposed to these.	N/A
4.3.11	Containers for liquids or gases	None	N/A
4.3.12	Flammable liquids	None	N/A
	Quantity of liquid (l)		N/A
	Flash point (°C)		N/A
4.3.13	Radiation		P
4.3.13.1	General	See below	P
4.3.13.2	Ionizing radiation	No ionizing radiation.	N/A
	Measured radiation (pA/kg)		—
	Measured high-voltage (kV)		—
	Measured focus voltage (kV)		—
	CRT markings		—
4.3.13.3	Effect of ultraviolet (UV) radiation on materials	No ultraviolet radiation	N/A
	Part, property, retention after test, flammability classification		N/A
4.3.13.4	Human exposure to ultraviolet (UV) radiation	No ultraviolet radiation	N/A
4.3.13.5	Lasers (including laser diodes) and LEDs	See below.	P
4.3.13.5.1	Lasers (including laser diodes)	Not used.	N/A
	Laser class		—

IEC 60950-1			
Clause	Requirement + Test	Result - Remark	Verdict
4.3.13.5.2	Light emitting diodes (LEDs)	Indicating LED on secondary is inherently Class1 according to IEC 60825-1.	P
4.3.13.6	Other types		N/A
4.4	Protection against hazardous moving parts		N/A
4.4.1	General		N/A
4.4.2	Protection in operator access areas		N/A
	Household and home/office document/media shredders		N/A
4.4.3	Protection in restricted access locations		N/A
4.4.4	Protection in service access areas		N/A
4.4.5	Protection against moving fan blades		N/A
4.4.5.1	General		N/A
	Not considered to cause pain or injury. a).....:		N/A
	Is considered to cause pain, not injury. b)		N/A
	Considered to cause injury. c)		N/A
4.4.5.2	Protection for users		N/A
	Use of symbol or warning		N/A
4.4.5.3	Protection for service persons		N/A
	Use of symbol or warning		N/A
4.5	Thermal requirements		P
4.5.1	General		P
4.5.2	Temperature tests		P
	Normal load condition per Annex L	Equipment loaded with rated output current.	—
4.5.3	Temperature limits for materials	(see appended table 4.5)	P
4.5.4	Touch temperature limits	(see appended table 4.5)	P
4.5.5	Resistance to abnormal heat	Bobbin materials of transformer T901 and some of L901 are Phenolic that is accepted without further tests. Others see appended table 4.5.5.	P
4.6	Openings in enclosures		P
4.6.1	Top and side openings	(see appended table 4.6.1 and 4.6.2)	P
	Dimensions (mm)		—

IEC 60950-1			
Clause	Requirement + Test	Result - Remark	Verdict
4.6.2	Bottoms of fire enclosures	(see appended table 4.6.1 and 4.6.2)	P
	Construction of the bottom, dimensions (mm) .. :		—
4.6.3	Doors or covers in fire enclosures	No doors or covers.	N/A
4.6.4	Openings in transportable equipment	Not transportable equipment.	N/A
4.6.4.1	Constructional design measures		N/A
	Dimensions (mm) :		—
4.6.4.2	Evaluation measures for larger openings		N/A
4.6.4.3	Use of metallized parts		N/A
4.6.5	Adhesives for constructional purposes	No adhesives for constructional purposes.	N/A
	Conditioning temperature (°C), time (weeks) :		—

4.7	Resistance to fire		P
4.7.1	Reducing the risk of ignition and spread of flame	No excessive temperatures. No easily burning materials employed. Fire enclosure provided. Safety relevant components used within their specified temperature limits.	P
	Method 1, selection and application of components wiring and materials	(see appended table 4.7)	P
	Method 2, application of all of simulated fault condition tests		N/A
4.7.2	Conditions for a fire enclosure	With having the following parts: - Components in primary; - Components in secondary not supplied by LPS; - Components in secondary supplied by LPS but not mounted on class V-1 or better material; - Insulated wiring. Internal metal enclosure used as fire enclosure.	P
4.7.2.1	Parts requiring a fire enclosure	See above.	P
4.7.2.2	Parts not requiring a fire enclosure	For components in secondary circuits supplied by LPS and mounted on PCB of class V-1 or better material.	P
4.7.3	Materials		P
4.7.3.1	General	PCB rated V-1	P

IEC 60950-1			
Clause	Requirement + Test	Result - Remark	Verdict
4.7.3.2	Materials for fire enclosures	Earthed metal enclosure is considered as fire enclosure, which complies without test.	P
4.7.3.3	Materials for components and other parts outside fire enclosures	HB plastic enclosure used, which is outside the fire enclosure.	P
4.7.3.4	Materials for components and other parts inside fire enclosures	Internal components except small parts are V-2, HF-2 or better.	P
4.7.3.5	Materials for air filter assemblies	No air filter.	N/A
4.7.3.6	Materials used in high-voltage components	No such high voltage components in this meaning	N/A

5	ELECTRICAL REQUIREMENTS AND SIMULATED ABNORMAL CONDITIONS		P
5.1	Touch current and protective conductor current		P
5.1.1	General	See sub-clauses 5.1.2 to 5.1.6.	P
5.1.2	Configuration of equipment under test (EUT)	See below.	P
5.1.2.1	Single connection to an a.c. mains supply	EUT has only one mains connection.	P
5.1.2.2	Redundant multiple connections to an a.c. mains supply		N/A
5.1.2.3	Simultaneous multiple connections to an a.c. mains supply		N/A
5.1.3	Test circuit	Using figure 5A.	P
5.1.4	Application of measuring instrument	Using measuring instrument in annex D.	P
5.1.5	Test procedure		P
5.1.6	Test measurements	(see appended table 5.1.6)	P
	Supply voltage (V)		—
	Measured touch current (mA)		—
	Max. allowed touch current (mA)		—
	Measured protective conductor current (mA)		—
	Max. allowed protective conductor current (mA)....		—
5.1.7	Equipment with touch current exceeding 3,5 mA	Touch current does not exceed 3.5mA.	N/A
5.1.7.1	General		N/A
5.1.7.2	Simultaneous multiple connections to the supply		N/A
5.1.8	Touch currents to telecommunication networks and cable distribution systems and from telecommunication networks	No TNV circuits.	N/A

IEC 60950-1			
Clause	Requirement + Test	Result - Remark	Verdict
5.1.8.1	Limitation of the touch current to a telecommunication network or to a cable distribution system		N/A
	Supply voltage (V)		—
	Measured touch current (mA)		—
	Max. allowed touch current (mA)		—
5.1.8.2	Summation of touch currents from telecommunication networks		N/A
	a) EUT with earthed telecommunication ports		N/A
	b) EUT whose telecommunication ports have no reference to protective earth		N/A

5.2	Electric strength		P
5.2.1	General	(see appended table 5.2)	P
5.2.2	Test procedure	(see appended table 5.2)	P

5.3	Abnormal operating and fault conditions		P
5.3.1	Protection against overload and abnormal operation	Ventilation openings blocked, output of power supply board overloaded, no unaccepted overheating of parts (see appended table 5.3)	P
5.3.2	Motors	Motors not used.	N/A
5.3.3	Transformers	(see appended Annex C and table 5.3)	P
5.3.4	Functional insulation.....	By short-circuited, results see appended table 5.3.	P
5.3.5	Electromechanical components	No electromechanical component.	N/A
5.3.6	Audio amplifiers in ITE		N/A
5.3.7	Simulation of faults	(see appended table 5.3.)	P
5.3.8	Unattended equipment	No such equipment.	N/A
5.3.9	Compliance criteria for abnormal operating and fault conditions		P
5.3.9.1	During the tests	No fire or molten metal occurred and no deformation of enclosure during the tests.	P
5.3.9.2	After the tests	No reduction of clearance and creepage distance. Electric strength test is made on basic, supplementary and reinforced insulation after test.	P

IEC 60950-1			
Clause	Requirement + Test	Result - Remark	Verdict
6	CONNECTION TO TELECOMMUNICATION NETWORKS		N/A
6.1	Protection of telecommunication network service persons, and users of other equipment connected to the network, from hazards in the equipment		N/A
6.1.1	Protection from hazardous voltages		N/A
6.1.2	Separation of the telecommunication network from earth		N/A
6.1.2.1	Requirements		N/A
	Supply voltage (V)		—
	Current in the test circuit (mA)		—
6.1.2.2	Exclusions		
6.2	Protection of equipment users from overvoltages on telecommunication networks		N/A
6.2.1	Separation requirements		N/A
6.2.2	Electric strength test procedure		N/A
6.2.2.1	Impulse test		N/A
6.2.2.2	Steady-state test		N/A
6.2.2.3	Compliance criteria		N/A
6.3	Protection of the telecommunication wiring system from overheating		N/A
	Max. output current (A)		—
	Current limiting method		—
7	CONNECTION TO CABLE DISTRIBUTION SYSTEMS		N/A
7.1	General		N/A
7.2	Protection of cable distribution system service persons, and users of other equipment connected to the system, from hazardous voltages in the equipment		N/A
7.3	Protection of equipment users from overvoltages on the cable distribution system		N/A
7.4	Insulation between primary circuits and cable distribution systems		N/A
7.4.1	General		N/A
7.4.2	Voltage surge test		N/A
7.4.3	Impulse test		N/A
A	ANNEX A, TESTS FOR RESISTANCE TO HEAT AND FIRE		N/A

IEC 60950-1			
Clause	Requirement + Test	Result - Remark	Verdict
A.1	Flammability test for fire enclosures of movable equipment having a total mass exceeding 18 kg, and of stationary equipment (see 4.7.3.2)		N/A
A.1.1	Samples		—
	Wall thickness (mm)		—
A.1.2	Conditioning of samples; temperature (°C)		N/A
A.1.3	Mounting of samples		N/A
A.1.4	Test flame (see IEC 60695-11-3)		N/A
	Flame A, B, C or D		—
A.1.5	Test procedure		N/A
A.1.6	Compliance criteria		N/A
	Sample 1 burning time (s)		—
	Sample 2 burning time (s)		—
	Sample 3 burning time (s)		—
A.2	Flammability test for fire enclosures of movable equipment having a total mass not exceeding 18 kg, and for material and components located inside fire enclosures (see 4.7.3.2 and 4.7.3.4)		N/A
A.2.1	Samples, material		—
	Wall thickness (mm)		—
A.2.2	Conditioning of samples; temperature (°C)		N/A
A.2.3	Mounting of samples		N/A
A.2.4	Test flame (see IEC 60695-11-4)		N/A
	Flame A, B or C		—
A.2.5	Test procedure		N/A
A.2.6	Compliance criteria		N/A
	Sample 1 burning time (s)		—
	Sample 2 burning time (s)		—
	Sample 3 burning time (s)		—
A.2.7	Alternative test acc. to IEC 60695-11-5, cl. 5 and 9		N/A
	Sample 1 burning time (s)		—
	Sample 2 burning time (s)		—
	Sample 3 burning time (s)		—
A.3	Hot flaming oil test (see 4.6.2)		N/A
A.3.1	Mounting of samples		N/A
A.3.2	Test procedure		N/A
A.3.3	Compliance criterion		N/A

IEC 60950-1			
Clause	Requirement + Test	Result - Remark	Verdict
B	ANNEX B, MOTOR TESTS UNDER ABNORMAL CONDITIONS (see 4.7.2.2 and 5.3.2)		N/A
B.1	General requirements		N/A
	Position		—
	ManuFacterer		—
	Type		—
	Rated values		—
B.2	Test conditions		N/A
B.3	Maximum temperatures		N/A
B.4	Running overload test		N/A
B.5	Locked-rotor overload test		N/A
	Test duration (days)		—
	Electric strength test: test voltage (V)		—
B.6	Running overload test for d.c. motors in secondary circuits		N/A
B.6.1	General		N/A
B.6.2	Test procedure		N/A
B.6.3	Alternative test procedure		N/A
B.6.4	Electric strength test; test voltage (V)		N/A
B.7	Locked-rotor overload test for d.c. motors in secondary circuits		N/A
B.7.1	General		N/A
B.7.2	Test procedure		N/A
B.7.3	Alternative test procedure		N/A
B.7.4	Electric strength test; test voltage (V)		N/A
B.8	Test for motors with capacitors		N/A
B.9	Test for three-phase motors		N/A
B.10	Test for series motors		N/A
	Operating voltage (V)		—

C	ANNEX C, TRANSFORMERS (see 1.5.4 and 5.3.3)		P
	Position	T901	—
	ManuFacterer	See appended table 1.5.1.	—
	Type	See appended table 1.5.1.	—
	Rated values	See appended table 1.5.1.	—
	Method of protection	By protection circuit.	—
C.1	Overload test	(see appended table 5.3)	P

IEC 60950-1			
Clause	Requirement + Test	Result - Remark	Verdict
C.2	Insulation	(see appended table 5.2)	P
	Protection from displacement of windings	Fixed by insulation tape.	P
D	ANNEX D, MEASURING INSTRUMENTS FOR TOUCH-CURRENT TESTS (see 5.1.4)		P
D.1	Measuring instrument		P
D.2	Alternative measuring instrument		N/A
E	ANNEX E, TEMPERATURE RISE OF A WINDING (see 1.4.13)		N/A
F	ANNEX F, MEASUREMENT OF CLEARANCES AND CREEPAGE DISTANCES (see 2.10 and Annex G)		P
G	ANNEX G, ALTERNATIVE METHOD FOR DETERMINING MINIMUM CLEARANCES		N/A
G.1	Clearances		N/A
G.1.1	General		N/A
G.1.2	Summary of the procedure for determining minimum clearances		N/A
G.2	Determination of mains transient voltage (V)		N/A
G.2.1	AC mains supply		N/A
G.2.2	Earthed d.c. mains supplies		N/A
G.2.3	Unearthed d.c. mains supplies		N/A
G.2.4	Battery operation		N/A
G.3	Determination of telecommunication network transient voltage (V)		N/A
G.4	Determination of required withstand voltage (V)		N/A
G.4.1	Mains transients and internal repetitive peaks		N/A
G.4.2	Transients from telecommunication networks		N/A
G.4.3	Combination of transients		N/A
G.4.4	Transients from cable distribution systems		N/A
G.5	Measurement of transient voltages (V)		N/A
	a) Transients from a mains supply		N/A
	For an a.c. mains supply		N/A
	For a d.c. mains supply		N/A
	b) Transients from a telecommunication network		N/A
G.6	Determination of minimum clearances		N/A

IEC 60950-1			
Clause	Requirement + Test	Result - Remark	Verdict

H	ANNEX H, IONIZING RADIATION (see 4.3.13)		N/A
----------	---	--	------------

J	ANNEX J, TABLE OF ELECTROCHEMICAL POTENTIALS (see 2.6.5.6)		P
	Metal(s) used	The internal metal enclosure is made of mild steel, screw spring washer are made of Ni on steel, the combined electrochemical potential is below 0.6V according to Table J.1.	—

K	ANNEX K, THERMAL CONTROLS (see 1.5.3 and 5.3.8)		N/A
K.1	Making and breaking capacity		N/A
K.2	Thermostat reliability; operating voltage (V)		N/A
K.3	Thermostat endurance test; operating voltage (V)		N/A
K.4	Temperature limiter endurance; operating voltage (V)		N/A
K.5	Thermal cut-out reliability		N/A
K.6	Stability of operation		N/A

L	ANNEX L, NORMAL LOAD CONDITIONS FOR SOME TYPES OF ELECTRICAL BUSINESS EQUIPMENT (see 1.2.2.1 and 4.5.2)		P
L.1	Typewriters		N/A
L.2	Adding machines and cash registers		N/A
L.3	Erasers		N/A
L.4	Pencil sharpeners		N/A
L.5	Duplicators and copy machines		N/A
L.6	Motor-operated files		N/A
L.7	Other business equipment	See 1.6.2.	P

M	ANNEX M, CRITERIA FOR TELEPHONE RINGING SIGNALS (see 2.3.1)		N/A
M.1	Introduction		N/A
M.2	Method A		N/A
M.3	Method B		N/A
M.3.1	Ringling signal		N/A
M.3.1.1	Frequency (Hz)		—
M.3.1.2	Voltage (V)		—
M.3.1.3	Cadence; time (s), voltage (V)		—

IEC 60950-1			
Clause	Requirement + Test	Result - Remark	Verdict
M.3.1.4	Single fault current (mA)		—
M.3.2	Tripping device and monitoring voltage		N/A
M.3.2.1	Conditions for use of a tripping device or a monitoring voltage		N/A
M.3.2.2	Tripping device		N/A
M.3.2.3	Monitoring voltage (V)		N/A
N	ANNEX N, IMPULSE TEST GENERATORS (see 1.5.7.2, 1.5.7.3, 2.10.3.9, 6.2.2.1, 7.3.2, 7.4.3 and Clause G.5)		N/A
N.1	ITU-T impulse test generators		N/A
N.2	IEC 60065 impulse test generator		N/A
P	ANNEX P, NORMATIVE REFERENCES		—
Q	ANNEX Q, Voltage dependent resistors (VDRs) (see 1.5.9.1)		N/A
	a) Preferred climatic categories		N/A
	b) Maximum continuous voltage		N/A
	c) Pulse current		N/A
R	ANNEX R, EXAMPLES OF REQUIREMENTS FOR QUALITY CONTROL PROGRAMMES		N/A
R.1	Minimum separation distances for unpopulated coated printed boards (see 2.10.6.2)		N/A
R.2	Reduced clearances (see 2.10.3)		N/A
S	ANNEX S, PROCEDURE FOR IMPULSE TESTING (see 6.2.2.3)		N/A
S.1	Test equipment		N/A
S.2	Test procedure		N/A
S.3	Examples of waveforms during impulse testing		N/A
T	ANNEX T, GUIDANCE ON PROTECTION AGAINST INGRESS OF WATER (see 1.1.2)		N/A
			—
U	ANNEX U, INSULATED WINDING WIRES FOR USE WITHOUT INTERLEAVED INSULATION (see 2.10.5.4)		N/A
			—

IEC 60950-1			
Clause	Requirement + Test	Result - Remark	Verdict
V	ANNEX V, AC POWER DISTRIBUTION SYSTEMS (see 1.6.1)		P
V.1	Introduction		P
V.2	TN power distribution systems		P
W	ANNEX W, SUMMATION OF TOUCH CURRENTS		N/A
W.1	Touch current from electronic circuits		N/A
W.1.1	Floating circuits		N/A
W.1.2	Earthed circuits		N/A
W.2	Interconnection of several equipments		N/A
W.2.1	Isolation		N/A
W.2.2	Common return, isolated from earth		N/A
W.2.3	Common return, connected to protective earth		N/A
X	ANNEX X, MAXIMUM HEATING EFFECT IN TRANSFORMER TESTS		N/A
X.1	Determination of maximum input current		N/A
X.2	Overload test procedure		N/A
Y	ANNEX Y, ULTRAVIOLET LIGHT CONDITIONING TEST (see 4.3.13.3)		N/A
Y.1	Test apparatus		N/A
Y.2	Mounting of test samples		N/A
Y.3	Carbon-arc light-exposure apparatus		N/A
Y.4	Xenon-arc light exposure apparatus		N/A
Z	ANNEX Z, OVERVOLTAGE CATEGORIES (see 2.10.3.2 and Clause G.2)		P
AA	ANNEX AA, MANDREL TEST (see 2.10.5.8)		N/A
BB	ANNEX BB, CHANGES IN THE SECOND EDITION		—
CC	ANNEX CC, Evaluation of integrated circuit (IC) current limiters		N/A
CC.1	General		N/A
CC.2	Test program 1.....		N/A
CC.3	Test program 2.....		N/A
DD	ANNEX DD, Requirements for the mounting means of rack-mounted equipment		N/A

IEC 60950-1			
Clause	Requirement + Test	Result - Remark	Verdict
DD.1	General		N/A
DD.2	Mechanical strength test, variable N.....:		N/A
DD.3	Mechanical strength test, 250N, including end stops.....:		N/A
DD.4	Compliance.....:		N/A

EE	ANNEX EE, Household and home/office document/media shredders		N/A
EE.1	General		N/A
EE.2	Markings and instructions		N/A
	Use of markings or symbols.....:		N/A
	Information of user instructions, maintenance and/or servicing instructions.....:		N/A
EE.3	Inadvertent reactivation test.....:		N/A
EE.4	Disconnection of power to hazardous moving parts:		N/A
	Use of markings or symbols.....:		N/A
EE.5	Protection against hazardous moving parts		N/A
	Test with test finger (Figure 2A)		N/A
	Test with wedge probe (Figure EE1 and EE2)		N/A

IEC 60950-1			
Clause	Requirement + Test	Result - Remark	Verdict

1.5.1	TABLE: list of critical components					P
Object/part no.	Manufacturer/ trademark	Type/model	Technical data	Standard	Mark(s) of conformity ¹ .	
LCD Panel for 18.5" model	TPV	TPM185B*-***** (*can be 0-9, A-Z or blank)	18.5" panel with LED backlight The declared power consumption is 11.4W and backlight input voltage is 35.2V in specification.	IEC 60950-1	Tested in equipment	
	AUO	M185XW** (*can be 0-9, A-Z or blank)	18.5" panel with LED backlight The declared power consumption is 10.2W and backlight input voltage is 36V in specification.	IEC 60950-1	Tested in equipment	
	AUO	M185XTN** (*can be 0-9, A-Z or blank)	18.5" panel with LED backlight The declared power consumption is 7.8W and backlight input voltage is 25.2V in specification.	IEC 60950-1	Tested in equipment	
	BOE	HM185WX*-*** (*can be 0-9, A-Z or blank)	18.5" panel with LED backlight The declared power consumption is 10.68W and backlight input voltage is 32V in specification.	IEC 60950-1	Tested in equipment	
	CHIMEI INNOLUX	M185B**-*** (*can be 0-9, A-Z or blank)	18.5" panel with LED backlight The declared power consumption is 11.11W and backlight input voltage is 27.2V in specification.	IEC 60950-1	Tested in equipment	
	L&T	LM185WH*-**** (*can be 0-9, A-Z or blank)	18.5" panel with LED backlight The declared power consumption is 12.8W and backlight input voltage is 51.2V in specification.	IEC 60950-1	Tested in equipment	

IEC 60950-1					
Clause	Requirement + Test			Result - Remark	Verdict
	SAMSUNG	LTM185AT** (*can be 0-9, A-Z or blank)	18.5" panel with LED backlight The declared power consumption is 11.9W and backlight input voltage is 35.2V in specification.	IEC 60950-1	Tested in equipment
LCD Panel for 21.5" model	TPV	TPM215HW**- ***** (*can be 0-9, A-Z or blank)	21.5" panel with LED backlight The declared power consumption is 19.35W and backlight input voltage is 41.6V in specification.	IEC 60950-1	Tested in equipment
	AUO	M215HTN** (*can be 0-9, A-Z or blank)	21.5" panel with LED backlight The declared power consumption is 15.54W and backlight input voltage is 38.4V in specification.	IEC 60950-1	Tested in equipment
	CHIMEI INNOLUX	M215H**-*** (*can be 0-9, A-Z or blank)	21.5" panel with LED backlight The declared power consumption is 16.97W and backlight input voltage is 34.65V in specification.	IEC 60950-1	Tested in equipment
	L&T	BM215WF*-**** (*can be 0-9, A-Z or blank)	21.5" panel with LED backlight The declared power consumption is 16.3W and backlight input voltage is 51.2V in specification.	IEC 60950-1	Tested in equipment
	L&T	LM215WF*-**** (*can be 0-9, A-Z or blank)	21.5" panel with LED backlight The declared power consumption is 14.35W and backlight input voltage is 45.0V in specification.	IEC 60950-1	Tested in equipment

IEC 60950-1					
Clause	Requirement + Test		Result - Remark		Verdict
Plastic enclosure	Cheil	SD-0150(+), VH-0810(+), VE-0812(+), NH-1000T(+), GC-0700(+), GC-1017(+), GC-0750(+), VE-1890(+), TP-1100(+), BF-0675(+), BF-0670(+), NH-1017(p), BF-0677(+), HS-7000(+), HG-0760(+), HR-1360(+)	HB or better, 2.0mm thickness min. 60°C	UL 94	UL
	Grand	D-150, D-1000	HB or better, 2.0mm thickness min. 60°C	UL 94	UL
	LG	HF-350, HF-380, AF312T1, AF342T, GN-5001TF(#), GN-5001RFD, GP-5008A-F, SE750(#), XG-568, XG-569C, GP-1000L, SE-750, GN-5001RF(T)	HB or better, 2.0mm thickness min. 60°C	UL 94	UL
	Chi Mei	PA-757(+), PH-88	HB or better, 2.0mm thickness min. 60°C	UL 94	UL
	King Fa	5197, HIPS-5197, HF-606, HF-626, FRABS-518, GAR-011C, JH960 6(M), FRHIPS-960, RS-900, RS-300, RS-400, GAR-011(L65), GAR-011(HG6), CK-100	HB or better, 2.0mm thickness min. 60°C	UL 94	UL
	Basf	GP-35, GP-22, 495F	HB or better, 2.0mm thickness min. 60°C	UL 94	UL

IEC 60950-1					
Clause	Requirement + Test			Result - Remark	Verdict
	Bayer	FR2000, FR3005	HB or better, 2.0mm thickness min. 60°C	UL 94	UL
	Teijin	TN-7500(v), TN-7500F(#), MN-3600H(#)	HB or better, 2.0mm thickness min. 60°C	UL 94	UL
	STYRON	STYRON A-TECH 1400	HB or better, 2.0mm thickness min. 60°C	UL 94	UL
	Haier	HRABS-RS, HRABS-HG, CR-3002	HB or better, 2.0mm thickness min. 60°C	UL 94	UL
	HINGLONG	HL-ABS-PCR85, HL-ABS-PCR65	HB or better, 2.0mm thickness min. 60°C	UL 94	UL
Metal enclosure (except part under power board)	--	--	Metal thickness: min. 0.6mm	--	--
Metal enclosure (under power board)	--	--	Metal thickness: min. 0.81mm	--	--
Base stand (optional)	--	--	HB or better	UL 94	UL
PCB	--	--	V-1 or better, min. 105°C	UL 94	UL
Power supply board: 715G5527					
AC-Inlet (CN901)	Solteam	ST-01	10A, 250Vac	IEC/ EN 60320-1	VDE, UL
	Zhang Jia Gang- Hua Jie	SA-4S, SA-4S-1	10A, 250Vac	IEC/ EN 60320-1	VDE, UL
	Rong Feng	SS-120, SS-7B	10A, 250Vac	IEC/ EN 60320-1	VDE, UL
	Inalways	0707-1, 0711-2, 0714	10A, 250Vac	IEC/ EN 60320-1	VDE, UL
	DELIKANG	CDJ-3, CDJ-3-1	10A, 250Vac	IEC/ EN 60320-1	VDE, UL
	TECX	TU-301 series	10A, 250Vac	IEC/ EN 60320-1	VDE, UL
	Yueqing Hongchang	DB-14	10A, 250Vac	IEC/ EN 60320-1	VDE, UL
Fuse (F901)	Wickmann	392, 382 series	T3.15AL, 250Vac	IEC/ EN 60127-1, IEC/ EN 60127-3	VDE, UL

IEC 60950-1					
Clause	Requirement + Test			Result - Remark	Verdict
	Littelfuse	382-series, 392, 0663 series	T3.15AL, 250Vac	IEC/ EN 60127-1, IEC/ EN 60127-3	VDE, UL
	Conquer	MET MST-series, PTU	T3.15AL, 250Vac	IEC/ EN 60127-1, IEC/ EN 60127-3	VDE, UL
	SAVE FUSETECH INC	SR-5 series, SS-5 series	T3.15AL, 250Vac	IEC/ EN 60127-1, IEC/ EN 60127-3	VDE, UL
	Walter	2000 series, 2010 series	T3.15AL, 250Vac	IEC/ EN 60127-1, IEC/ EN 60127-3	VDE, UL
Fuse (F902) (optional)	Wickmann	392, 382 series	T5AL, 250Vac	IEC/ EN 60127-1, IEC/ EN 60127-3	VDE, UL
	Littelfuse	382-series, 392, 0663 series	T5AL, 250Vac	IEC/ EN 60127-1, IEC/ EN 60127-3	VDE, UL
	Conquer	MET MST-series, PTU	T5AL, 250Vac	IEC/ EN 60127-1, IEC/ EN 60127-3	VDE, UL
	SAVE FUSETECH INC	SR-5 series, SS-5 series	T5AL, 250Vac	IEC/ EN 60127-1, IEC/ EN 60127-3	VDE, UL
	Walter	2000 series, 2010 series	T5AL, 250Vac	IEC/ EN 60127-1, IEC/ EN 60127-3	VDE, UL
Y- Capacitor (C900, C902, C903) Y1 or Y2 type (optional)	Walsin	AC, AH	Max. 4700pF, 250Vac, 85°C	IEC/ EN 60384-14	VDE, UL
	TDK	CS, CD	Max. 4700pF, 250Vac, 85°C	IEC/ EN 60384-14	VDE, UL
	Murata	KH, KX	Max. 4700pF, 250Vac, 85°C	IEC/ EN 60384-14	VDE, UL
	JYA-NAY	JY, JN	Max. 4700pF, 250Vac, 85°C	IEC/ EN 60384-14	VDE, UL

IEC 60950-1					
Clause	Requirement + Test			Result - Remark	Verdict
	Hongming	F	Max. 4700pF, 250Vac, 85°C	IEC/ EN 60384-14	VDE, UL
	Wansheng	CT7	Max. 4700pF, 250Vac, 85°C	IEC/ EN 60384-14	VDE, UL
	Haohua	CT7	Max. 4700pF, 250Vac, 85°C	IEC/ EN 60384-14	VDE, UL
	Samwha	SD	Max. 4700pF, 250Vac, 85°C	IEC/ EN 60384-14	VDE, UL
	Matsushita	NS-A, NS-B	Max. 4700pF, 250Vac, 85°C	IEC/ EN 60384-14	VDE, UL
	Success	SB, SE	Max. 4700pF, 250Vac, 85°C	IEC/ EN 60384-14	VDE, UL
	Yinan	CT81	Max. 4700pF, 250Vac, 85°C	IEC/ EN 60384-14	VDE, UL
X-Capacitor (X1 or X2 type) (C904) (optional)	Ultra Tech Xiphi	HQX	Max. 0.22μF, 250Vac, 85°C	IEC/ EN 60384-14	VDE, UL
	Faratronic	MKP62	Max. 0.22μF, 250Vac, 85°C	IEC/ EN 60384-14	VDE, UL
	Hua Jung	MKP	Max. 0.22μF, 250Vac, 85°C	IEC/ EN 60384-14	ENEC(Semk o), UL
	Europtronic	MPX, MPX2	Max. 0.22μF, 250Vac, 85°C	IEC/ EN 60384-14	VDE, UL
	Liow Gu	GS-L	Max. 0.22μF, 250Vac, 85°C	IEC/ EN 60384-14	VDE, UL
	Arcotronics	R.46	Max. 0.22μF, 250Vac, 85°C	IEC/ EN 60384-14	ENEC(IMQ), UL
	EPCOS	B3292#	Max. 0.22μF, 250Vac, 85°C	IEC/ EN 60384-14	VDE, UL
	ZhuHai Sung Ho Electronics Co., Ltd.	CMPP	Max. 0.22μF, 250Vac, 85°C	IEC/ EN 60384-14	VDE, UL
Photo Coupler (U902)	Sharp	PC123	Di=0.7mm, int. cr=thermal cycling ³ , ext. cr=8.0mm, 3000Vac, 100°C	DIN EN 60747-5-2, UL1577	VDE, UL, Semko, Nemko, Fimko
	Vishay Semiconductor	TCET1103	Di=0.6mm, int. cr=4.7mm, ext. cr=8.4mm, 3000Vac, 100°C	DIN EN 60747-5-2, UL1577	VDE, UL, Semko, Fimko
	Everlight Electronics Co., Ltd.	EL817, EL817M	Di=0.5mm, int. cr=6.0mm, ext. cr=7.7mm, 3000Vac, 100°C	DIN EN 60747-5-2, UL1577	VDE, UL, Semko, Nemko, Fimko

IEC 60950-1					
Clause	Requirement + Test		Result - Remark		Verdict
	Everlight Electronics Co., Ltd.	EL1013	Di=0.4mm, int. cr=thermal cycling ³ , ext. cr=8.0mm, 3000Vac, 100 °C	DIN EN 60747-5-2, UL1577	VDE, UL, Semko
	Lite-on	LTV-817	Di=0.4mm, int. cr=4.0mm, ext. cr=8.0mm, 3000Vac, 100 °C	DIN EN 60747-5-2, UL1577	VDE, UL
	Renesas	PS2561-1 PS2561L-1 PS2561L1-1 PS2561L2-1 PS2561DL1-1	Di=0.4mm, int. cr=thermal cycling ³ , ext. cr=8.0mm, 3000Vac, 100 °C	DIN EN 60747-5-2, UL1577	VDE, UL, Nemko, Fimko
	TOSHIBA	TLP781F TLP781	Di=0.4mm, int. cr=thermal cycling ³ , ext. cr=8.0mm, 3000Vac, 100 °C	DIN EN 60747-5-2, UL1577	VDE, UL, Semko, Fimko
	TOSHIBA	TLP421F	Di=0.4mm, int. cr=thermal cycling ³ , ext. cr=8.0mm, 3000Vac, 100 °C	DIN EN 60747-5-2, UL1577	VDE, UL, Semko, Fimko
Thermistor (NR901)	--	--	Min. 3Ω at 25 °C, min. 2A	--	--
Bleeder Resistor (R900, R901, R902)	--	SMD type	Max. 1MΩ, min. 1/4W	--	--
Bridging Diode (BD901)	--	--	Min.600V, min.2A	--	--
Ripple Capacitor (C907)	--	--	45-150μF, min. 450V, 105 °C	--	--
Line Choke (L901) (Optional)	Dadon	73G174-65-H	105 °C	--	--
	TPV	73G174-65-V	105 °C	--	--
	DARFON	73G174-65-DN	105 °C	--	--
	TaiChang	73G174-65-S	105 °C	--	--
	TDK	73G174-65-T	105 °C	--	--
	Litai	73G174-65-L	105 °C	--	--
	YUVA	73G174-65-N	105 °C	--	--
	ASET	73G174-65-X	105 °C	--	--

IEC 60950-1					
Clause	Requirement + Test			Result - Remark	Verdict
Transformer (T901) (Alt.)	YUVA	80GL19P-39-N	Class B	Applicable part according to IEC60950-1 and IEC 60085	Accepted by TÜV Rheinland
Bobbin	Sumitomo Bakelite Co., Ltd.	PM-9820	Phenolic, V-0, 150°C	UL94	UL
Margin tape	SYMBIO INC	No.35661\$	130°C	UL510	UL
	3M	No.44(a)	130°C	UL510	UL
Insulation tape	SYMBIO INC	No.35660Y*(%)	130°C	UL510	UL
	JINGJIANG YAHUA	No.CT(c)	130°C	UL510	UL
Transformer (T901) (Alt.)	TPV	80GL19P-39-V	Class B	Applicable part according to IEC60950-1 and IEC 60085	Accepted by TÜV Rheinland
Bobbin	Sumitomo Bakelite Co., Ltd.	PM-9820	Phenolic, V-0, 150°C	UL94	UL
Margin tape	SYMBIO INC	No.35661\$	130°C	UL510	UL
Insulation tape	SYMBIO INC	No.35660Y*(%)	130°C	UL510	UL
Transformer (T901) (Alt.)	TAICHANG	80GL19P-39-S	Class B	Applicable part according to IEC60950-1 and IEC 60085	Accepted by TÜV Rheinland
Bobbin	Sumitomo Bakelite Co., Ltd.	PM-9820	Phenolic, V-0, 150°C	UL94	UL
Margin tape	JINGJIANG YAHUA	No.WF(c)	130°C	UL510	UL
Insulation tape	JINGJIANG YAHUA	No.CT(c)	130°C	UL510	UL
Transformer (T901) (Alt.)	CHENPING	80GL19P-39-CP	Class B	Applicable part according to IEC60950-1 and IEC 60085	Accepted by TÜV Rheinland
Bobbin	Sumitomo Bakelite Co., Ltd.	PM-9820 PM-9630	Phenolic, V-0, 150°C	UL94	UL
Margin tape	SYMBIO INC	No.35661\$	130°C	UL510	UL
	JINGJIANG YAHUA	No.WF(c)	130°C	UL510	UL

IEC 60950-1					
Clause	Requirement + Test			Result - Remark	Verdict
Insulation tape	JINGJIANG YAHUA	No.CT(c)	130 °C	UL510	UL
<p>Supplementary information:</p> <ol style="list-style-type: none"> 1. Provided evidence ensures the agreed level of compliance. 2. 'Di' means distance through insulation, 'int.' Means internal distance of creepage and 'ext.' Means external distance of creepage. 3. There is no any internal creepage distance. Test according to IEC60950-1:2001, cl. 2.10.8 (same as requirement in IEC60950-1:2005, cl. 2.10.9) has been carried out ten times for the components at 100 °C / 25 °C / 0 °C / 25 °C. Humidity treatment of 48 hours as well as electric strength tests at 3000V / 1 minute was carried out to the component after thermal cycling test. 4. All sources of photo coupler were certified according to DIN EN60747-5-2 which in compliance with the requirements and provisions of IEC 60747-5-5. 5. All sources of photo coupler were in compliance with CTL DSH 759 decision. 6. All sources of transformer were checked with same construction. 					

IEC 60950-1			
Clause	Requirement + Test	Result - Remark	Verdict

1.6.2	TABLE: electrical data (in normal conditions)						P
Fuse #	I _{rated} (A)	U(V)/F(Hz)	P (W)	I (A)	I _{fuse} (A)	Condition/status	
Test on model 185LM000**, VGA mode							
F901	--	90/50	13.4	0.24	0.24	Maximum normal load	
F901	--	90/60	13.4	0.24	0.24	Maximum normal load	
F901	1.5	100/50	13.3	0.23	0.23	Maximum normal load	
F901	1.5	100/60	13.3	0.23	0.23	Maximum normal load	
F901	1.5	240/50	13.1	0.13	0.13	Maximum normal load	
F901	1.5	240/60	13.1	0.13	0.13	Maximum normal load	
F901	--	264/50	13.2	0.12	0.12	Maximum normal load	
F901	--	264/60	13.2	0.12	0.12	Maximum normal load	
Test on model 215LM000**, VGA mode							
F901	--	90/50	16.9	0.31	0.31	Maximum normal load	
F901	--	90/60	16.9	0.31	0.31	Maximum normal load	
F901	1.5	100/50	16.8	0.28	0.28	Maximum normal load	
F901	1.5	100/60	16.8	0.28	0.28	Maximum normal load	
F901	1.5	240/50	16.6	0.15	0.15	Maximum normal load	
F901	1.5	240/60	16.6	0.15	0.15	Maximum normal load	
F901	--	264/50	16.6	0.14	0.14	Maximum normal load	
F901	--	264/60	16.6	0.14	0.14	Maximum normal load	
Supplementary information:							
1. Maximum normal load: maximum brightness, maximum contrast, full white screen.							
2. Panel LM185WH*-**** (L&T) chosen for model 185LM000** and panel TPM215HW**-***** chosen for model 215LM000** during the test, due to the higher power consumption specified in panel spec than any other panels of each size.							

2.1.1.5	TABLE: max. V, A, VA test				P
Voltage (rated) (V)	Current (rated) (A)	Voltage (max.) (V)	Current (max.) (A)	VA (max.) (VA)	
+5V output	--	5.1	4.6	22	
+15V output	--	18.0	2.4	32	
Supplementary information: Test voltage is 264Vac, 60Hz					

IEC 60950-1			
Clause	Requirement + Test	Result - Remark	Verdict

2.1.1.7	TABLE: discharge test			P
Condition	τ calculated (s)	τ measured (s)	t u→ 0V (s)	Comments
System on (with fuse in, L-N)	0.66	0.58	--	Vo=375Vpk, 37% of Vo=138.75Vpk.
Supplementary information: Overall capacity: C904 = 0.22 μ F, Discharge resistor: R900(1M Ω) + R901(1M Ω) + R902(1M Ω) = 3M Ω , Supplied with 264V/60Hz.				

2.2.2	TABLE: Hazardous voltage measurement			P
Component (measured between)	max. voltage (V) (normal operation)		Voltage Limiting Components	
	V peak	V d.c.		
T901: Pin 6,7 - pin 10	22.7	--		
T901: Pin 8,9 - pin 10	51.0	--		
After R904 to earth	44.2	--		
After C910 to earth	24.7	--		
After C919/D903 to earth	--	13.8	C929/D901	
After L801 to earth	--	21.7		
After D801 to earth (converter output)	--	35.1		
Fault test performed on voltage limiting components	Voltage measured (V) in SELV circuits (V peak or V d.c.)			
C910 short	16.6 (+15V to earth)			
D903 short	0 (+15V to earth)			
L801 short	0 (CN804 pin 3,4 to earth)			
Supplementary information: Input Voltage is 240Vac, 60Hz				

2.4.2	TABLE: limited current circuit measurement					P
Location	Voltage (V)	Current (mA)	Freq. (kHz)	Limit (mA)	Comments	
C900 secondary pin - GND	1.8	0.9	30	21	--	
Note(s): 1. Input Voltage is 240Vac, 60Hz.						

IEC 60950-1			
Clause	Requirement + Test	Result - Remark	Verdict
2.5	TABLE: Limited power source measurement		P
	Limits	Measured	Verdict
Location: +15V output			
According to Table 2B (normal condition), Uoc=18.0V			
current (in A)	8	2.4	P
apparent power (in VA)	100	32	P
According to Table 2B (single fault condition), ZD901 shorted			
current (in A)	8	2.8	P
apparent power (in VA)	100	35	P
According to Table 2B (single fault condition), R913 shorted			
current (in A)	8	0	P
apparent power (in VA)	100	0	P
According to Table 2B (single fault condition), R915 shorted			
current (in A)	8	0	P
apparent power (in VA)	100	0	P
According to Table 2B (single fault condition), U903 pin A-K shorted			
current (in A)	8	0	P
apparent power (in VA)	100	0	P
According to Table 2B (single fault condition), U902 pin 1 opened			
current (in A)	8	0	P
apparent power (in VA)	100	0	P
Location: +5V output			
According to Table 2B (normal condition), Uoc=5.1V			
current (in A)	8	4.6	P
apparent power (in VA)	100	22	P
According to Table 2B (single fault condition), R903 shorted			
current (in A)	8	3.0	P
apparent power (in VA)	100	17	P
According to Table 2B (single fault condition), R913 shorted			
current (in A)	8	0	P
apparent power (in VA)	100	0	P
According to Table 2B (single fault condition), R915 shorted			
current (in A)	8	0	P
apparent power (in VA)	100	0	P

IEC 60950-1			
Clause	Requirement + Test	Result - Remark	Verdict

According to Table 2B (single fault condition), U903 pin A-K shorted			
current (in A)	8	0	P
apparent power (in VA)	100	0	P
According to Table 2B (single fault condition), U902 pin 1 opened			
current (in A)	8	0	P
apparent power (in VA)	100	0	P
Supplementary information:			
1. Input Voltage is 240Vac, 60Hz.			

2.6.3.4	TABLE: ground continue test		P
Location	Resistance measured (mΩ)	Comments	
PE terminal of AC inlet to internal metal enclosure	3.0	Test with 32A, 2 minutes	
PE terminal of AC inlet to internal metal enclosure	3.0	Test with 40A, 2 minutes	
PE terminal of AC inlet to C902 trace	5.0	Test with 32A, 2 minutes	
PE terminal of AC inlet to C902 trace	5.0	Test with 40A, 2 minutes	
PE terminal of AC inlet to C903 trace	5.0	Test with 32A, 2 minutes	
PE terminal of AC inlet to C903 trace	5.0	Test with 40A, 2 minutes	
Supplementary information:			

2.10.2	Table: working voltage measurement			P
Location	Peak voltage (V)	RMS voltage (V)	Comments	
T901: Pin 1 to pin 6,7	359	198		
T901: Pin 1 to pin 8,9	388	200		
T901: Pin 1 to pin 10	341	197		
T901: Pin 3 to pin 6,7	491	245		
T901: Pin 3 to pin 8,9	472	240		
T901: Pin 3 to pin 10	492	249	Max. Vpeak & Vrms	
T901: Pin 4 to pin 6,7	394	196		
T901: Pin 4 to pin 8,9	369	196		
T901: Pin 4 to pin 10	413	196		

IEC 60950-1			
Clause	Requirement + Test	Result - Remark	Verdict
T901: Pin 5 to pin 6,7	350	195	
T901: Pin 5 to pin 8,9	359	196	
T901: Pin 5 to pin 10	347	196	
U902 Pin 1-3	344	217	
U902 Pin 1-4	347	220	
U902 Pin 2-3	351	223	
U902 Pin 2-4	254	225	
Supplementary information: Input Voltage is 240Vac, 60Hz			

2.10.3 and 2.10.4	TABLE: clearance and creepage distance measurements						P
Clearance cl and creepage distance dcr at/of:	U p (V)	U r.m.s. (V)	Required cl (mm)	cl (mm)	Required dcr (mm)	dcr (mm)	
Functional:							
Under fuse (F901)	420	250	2.3	2.8	2.5	3.6	
Before fuse (between L-N)	420	250	2.3	8.9	2.5	8.9	
Basic / supplementary:							
Line-GND	420	250	3.0	3.0	3.0	3.8	
Neutral-GND	420	250	3.0	3.0	3.0	3.8	
Under C900	420	250	3.0	8.0	3.0	8.0	
Under C902	420	250	3.0	3.9	3.0	4.7	
Under C903	420	250	3.0	7.6	3.0	8.6	
Primary component C906 to core of T901	492	250	3.2	7.1	3.2	7.3	
Secondary Jumper J9013 to core of T901	492	250	3.2	10.1	3.2	1.	
Primary component (main transformer) to metal enclosure	492	250	3.2	8.0	3.2	1.	
Primary component trace to panel	492	250	3.2	5.5	3.2	1.	
Reinforced:							
Under T901	492	250	6.3	8.0	6.3	8.0	
U902 primary pin to U902 secondary pin (trace side)	420	250	6.0	7.8	6.0	8.6	
Primary component NR901 to secondary component Q903 (trace side)	420	250	6.0	8.0	6.0	8.0	

IEC 60950-1			
Clause	Requirement + Test	Result - Remark	Verdict

Supplementary information:

- At least 10mm measured for creepage or clearance where indicated.
- Core of main transformer T901 consider as floating.
- Two layers of insulation tape wrapped external of transformer T901. See table C.2 for pri. Pin to core as smallest distance.
- The basic insulation secondary wires are far enough from the primary components to fulfil the requirement for supplementary insulation.
- Glued component: C907.
- Considered altitude correction factor for clearances for an altitude of 5000m (based on IEC 60664-1:1992): 1.48.
- For clearance and creepage that did not describe above are far larger than limit above.

2.10.5	TABLE: distance through insulation measurements			P
Distance through insulation di at/of:	U r.m.s. (V)	Test voltage (V)	Required di (mm)	di (mm)
Photo coupler (reinforced insulation)	250	3000	0.4	1.
Supplementary information:				
1. For approved component source see appended table 1.5.1.				

4.5	TABLE: maximum temperatures			P
	test voltage (V)	a) 90V/50Hz, b) 264V/60Hz		—
	t1 (°C)	--		—
	t2 (°C)	--		—
Maximum temperature T of part/at:		T (°C)		allowed T _{max} (°C)
Test voltage		a)	b)	--
Test on model 185LM000**				
AC Inlet body CN901 (on power board)		34.9	32.0	44.3
C902 body (on power board)		37.9	36.6	59.3
PCB near NR901 (on power board)		40.8	41.4	79.3
C904 body (on power board)		37.5	39.7	59.3
L901 coil (on power board)		40.0	41.7	79.3
PCB near BD901 (on power board)		40.8	39.8	79.3
C907 body (on power board)		41.5	42.1	79.3
C900 body (on power board)		44.8	40.9	59.3
T901 coil (on power board)		51.0	48.3	84.3
T901 core (on power board)		45.7	43.1	84.3

IEC 60950-1			
Clause	Requirement + Test	Result - Remark	Verdict
U902 body (on power board)	43.5	41.7	74.3
PCB near D906 (on power board)	45.3	44.8	79.3
PCB near U901 (on power board)	46.6	47.3	79.3
PCB near L801 (on power board)	50.5	51.8	79.3
PCB near U801 (on power board)	43.6	43.1	79.3
PCB near U401 (on main board)	45.8	44.0	79.3
Metal enclosure	36.2	35.0	44.3
Plastic enclosure inside near T901	33.8	34.1	--
Panel surface	38.6	39.4	69.3
Plastic enclosure outside	28.5	28.1	34.3
Ambient	14.3	14.7	--
Test on model 215LM000**			
AC Inlet body CN901 (on power board)	36.2	37.9	45.5
C902 body (on power board)	39.4	39.2	60.5
PCB near NR901 (on power board)	43.7	41.2	80.5
C904 body (on power board)	41.1	37.7	60.5
L901 coil (on power board)	44.2	42.3	80.5
PCB near BD901 (on power board)	45.2	40.8	80.5
C907 body (on power board)	44.5	40.1	80.5
C900 body (on power board)	43.8	40.9	60.5
T901 coil (on power board)	51.0	50.6	85.5
T901 core (on power board)	47.2	45.7	85.5
U902 body (on power board)	46.1	43.5	75.5
PCB near D906 (on power board)	47.2	46.2	80.5
PCB near U901 (on power board)	49.1	45.5	80.5
PCB near L801 (on power board)	50.5	48.2	80.5
PCB near U801 (on power board)	45.1	46.7	80.5
PCB near U401 (on main board)	45.8	44.0	80.5
Metal enclosure	37.4	36.3	45.5
Plastic enclosure inside near T901	35.2	32.6	--
Panel surface	38.0	39.0	70.5
Plastic enclosure outside	28.3	25.2	35.5
Ambient	15.5	15.6	--

IEC 60950-1					
Clause	Requirement + Test			Result - Remark	Verdict
Temperature T of winding:	R ₁ (Ω)	R ₂ (Ω)	T (°C)	allowed T _{max} (°C)	insulation class
Supplementary information:					
1. The temperatures were measured under the worse case normal mode defined in 1.2.2.1 and as described in sub-clause 1.6.2 at voltages as described above.					
2. With a specified ambient temperature of 40°C. Temperature limits are calculated as follows:					
Winding components providing safety isolation:					
- Class B → T _{max} = 120 - 10 - 40 + T _{amb}					
Components with maximum absolute temperature of others:					
- T _{max} = T _{max} of component - 40 + T _{amb}					

4.5.5	TABLE: ball pressure test of thermoplastic parts		P
	allowed impression diameter (mm)	≤ 2 mm	—
Part	Test temperature (°C)	Impression diameter (mm)	
Line choke (L901), Chang Chun, type PBT-4115	125	1.0	
Line choke (L901), Chang Chun, type PBT-4130	125	1.0	
Supplementary information:			

4.6.1, 4.6.2	Table: enclosure openings		P
Location	Size (mm)	Comments	
External Plastic enclosure			
Top	Numerous rectangle openings: max. 18.9mm x 1.9mm.	No hazardous part within vertical projection of 5° from the opening.	
Rear	No opening.	--	
Left	No opening.	--	
Right	No opening.	--	
Bottom	No opening.	--	
Internal metal chassis			
Top	1) Numerous circle openings: Ø4.8mm; 2) One rectangle opening above power board: 20.0mm x 8.8mm.	1) Openings do not exceed 5mm in any dimension. No hazards. 2) No hazardous part within vertical projection of 5° from the opening.	

IEC 60950-1			
Clause	Requirement + Test	Result - Remark	Verdict
Rear	1) Two circle openings above main board: \varnothing 14.0mm; 2) One rectangle opening above power board converter part: 68.7mm x 13.5mm.	No hazardous part within vertical projection of 5° from the opening.	
Left	One rectangle opening near main board: 32.0mm x 14.0mm.	No hazardous part within vertical projection of 5° from the opening.	
Right	One rectangle opening near power board converter part: 68.7mm x 26.1mm	No hazardous part within vertical projection of 5° from the opening.	
Bottom	1) One half-circle opening near main board: \varnothing 12.0mm; 2) No opening under power board side.	Main board is supplied by LPS and mounted on V-1 material. The opening is not within the area of hazardous components on the power board traced out by the 5° angle. No hazards.	

4.7	Table: resistance to fire				P
Part	Manufacturer of material	Type of material	Thickness (mm)	Flammability class	
PCB	--	--	--	V-1	
Plastic enclosure *	--	--	--	HB	
Supplementary information: See table 1.5.1.					
* Not fire enclosure.					

5.1.6	TABLE: touch current measurement				P
Condition	L → terminal A (mA)	N → terminal A (mA)	Limit (mA)	Comments	
Unit on	0.60	0.60	3.5	Switch "e" open, terminal A at earthed metal part	
Unit on	0.01	0.01	0.25	Switch "e" close, terminal A at pin of VGA connector*	
Unit on	0.01	0.01	0.25	Switch "e" close, terminal A at accessible plastic enclosure with metal foil.	
Supplementary information: Supplied with 264V/60Hz.					
* Test performed with functional earthing disconnected.					

IEC 60950-1			
Clause	Requirement + Test	Result - Remark	Verdict
5.2	TABLE: electric strength tests and impulse tests		P
Test voltage applied between:		Test voltage (V)	Breakdown
Basic/supplementary:			
Unit primary to earthed metal part		AC1740	No
T901 ¹⁾ : primary to core		AC1740	No
T901 ¹⁾ : secondary to core		AC1740	No
Reinforced:			
L/N to accessible plastic enclosure with metal foil		AC 3000	No
Unit primary to secondary (output)		DC 4242	No
T901 ¹⁾ : primary to secondary		AC 3000	No
T901 ¹⁾ : each combination of two layers of insulation tape		AC 3000	No
Supplementary information:			
1. For all sources of T901;			
2. Test after humidity conditioning test.			

5.3	TABLE: Fault condition tests					P
	Ambient temperature (°C)		See below			—
	Power source for EUT: ManuFacterer, model/type, output rating					—
Component No.	Fault	Supply voltage (V)	Test time	Fuse #	Fuse current (A)	Observation
Ventilation openings	block ed	264	2.0 hrs	F901	0.13	Unit operated normally, no hazards, no damaged. After temperature reached stable, max. measured temp. in T901 coil = 53.7°C, T901 core = 48.7°C, U902 = 46.4°C, ambient = 14.2°C.
BD901 pin1-3	s-c	264	<1 sec	F901	--	Fuse F901 opened instantly, no hazard.
C907	s-c	264	<1 sec	F901	--	Fuse F901 opened instantly, no hazard.
U901 pin 4-5	s-c	264	< 1 sec	F901	--	F901 opened instantly, R921, R920, R903 and U901 damaged. No hazard. This test was repeated twice (three tests total) with same result.

IEC 60950-1						
Clause	Requirement + Test				Result - Remark	Verdict
U901 pin 2-5	s-c	264	< 1 sec	F901	--	F901 opened instantly, R921, R920, R925 and U901 damaged. No hazard. This test was repeated twice (three tests total) with same result.
U901 pin 3-6	s-c	264	< 1 sec	F901	0.06	Unit shut down, no hazard.
T901 pin6,7 to pin10	s-c	264	5 min	F901	0.06	Unit shut down, no hazard.
T901 pin8,9 to pin10	s-c	264	5 min	F901	0.06	Unit shut down, no hazard.
T901 pin1 to pin3	s-c	264	5 min	F901	0.03	Unit shut down, no hazard.
T901 pin4 to pin5	s-c	264	5 min	F901	0.06	Unit shut down, no hazard.
U902 pin1-2	s-c	264	5 min	F901	0.05	Unit shut down, no hazard.
U902 pin3-4	s-c	264	5 min	F901	0.05	Unit shut down, no hazard.
U902 pin 1	o-c	264	5 min	F901	0.05	Unit shut down, no hazard.
D902	s-c	264	5 min	F901	0.04	Unit shut down, no hazard.
D906	s-c	264	5 min	F901	0.04	Unit shut down, no hazard.
+5V output to earth	s-c	264	5 min	F901	0.04	Unit shut down, no hazard.
+15V output to earth	s-c	264	5 min	F901	0.04	Unit shut down, no hazard.
+5V output to +15V output	s-c	264	5 min	F901	0.04	Unit shut down, no hazard.
T901 pin8,9-pin10 after D903(+15V)	o-l	264	8 hrs	F901	0.54	Max. measured temp. in T901 coil = 82°C, T901 core = 76°C, U902 = 69°C, ambient = 14.1°C, before shut down winding is loaded to 2.0A. No hazards.

IEC 60950-1						
Clause	Requirement + Test				Result - Remark	Verdict
T901 pin6,7- pin10 after D906(+5V)	o-l	264	11 hrs	F901	0.51	Max. measured temp. in T901 coil = 81 °C, T901 core = 74 °C, U902 = 65 °C, ambient = 14.7 °C, before shut down winding is loaded to 3.5A. No hazards.
Supplementary information:						
<ol style="list-style-type: none"> The unit passed 3000V hi-pot test between primary and accessible output connector after single fault test above. In fault column, where s-c=short-circuited, o-c=open-circuited, o-l = overload. For fuse opened conditions were tested with each source of fuse. For component damaged conditions have been repeated twice (three tests total) with same result. Temp. limit of transformer according to table C.1 is $175^{\circ}\text{C} - 10 - (40^{\circ}\text{C} - 14.1^{\circ}\text{C}) = 139.1^{\circ}\text{C}$ (worst case) for Class B. The temp. limit of U902 is: $125^{\circ}\text{C} - (40^{\circ}\text{C} - 14.1^{\circ}\text{C}) = 99.1^{\circ}\text{C}$. 						

IEC 60950-1			
Clause	Requirement + Test	Result - Remark	Verdict
C.2	Safety isolation transformer		P
Construction details:			
Transformer part name: T901			
Manufacturer: See appended table 1.5.1			
Type: See appended table 1.5.1			
Recurring peak voltage	492V		
Required clearance for reinforced insulation (from table 2H and 2J)	6.3mm		
Effective voltage rms	250V		
Required creepage distance for reinforced insulation (from table 2L)	6.3mm		
Measured min. creepage distance			
Location	inside (mm)	outside (mm)	
Primary to secondary	6.4	21.5mm (between primary and secondary solder pins.)	
Primary to core	3.2	4.4mm (between primary solder pin and core.)	
Secondary to core	3.2	4.4mm (between secondary solder pin and core.)	
Measured min. clearances			
Location	inside (mm)	outside (mm)	
Primary to secondary	6.4	21.5mm (between primary and secondary solder pins.)	
Primary to core	3.2	4.4mm (between primary solder pin and core.)	
Secondary to core	3.2	4.4mm (between secondary solder pin and core.)	

IEC 60950-1			
Clause	Requirement + Test	Result - Remark	Verdict

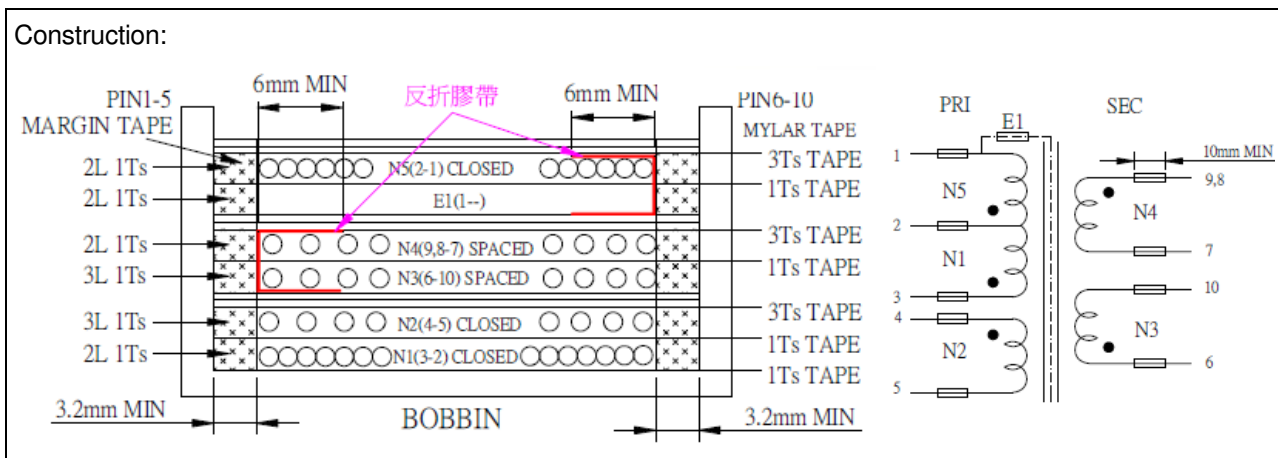

Concentric windings on phenolic bobbin. Three layers insulation tape are provided around outer winding and outer winding is primary. Three layers of insulation tape are provided between the primary windings and secondary windings. At least 3.2mm margin tape is provided at both primary solder pin side and secondary solder pin side. One layer of insulation type is provided around the core. All winding leads are covered by tube.

Pin numbers	
Pri.	pin 1-2-3, pin 4-5, pin 1-copper foil
Sec.	pin 7-8,9, pin 6-10
Bobbin	
	Sumitomo Bakelite Co., Ltd., type PM-9820, PM-9630, phenolic, V-0, 150 °C
Thickness	min. 0.45mm
Electric strength test	
With 3000 V a.c. after humidity treatment	
Result	Pass

IEC60950_1C - ATTACHMENT			
Clause	Requirement + Test	Result - Remark	Verdict

ATTACHMENT TO TEST REPORT IEC 60950-1 EUROPEAN GROUP DIFFERENCES AND NATIONAL DIFFERENCES Information technology equipment – Safety – Part 1: General requirements	
Differences according to.....:	EN 60950-1:2006/A11:2009/A1:2010/A12:2011
Attachment Form No.:	EU_GD_IEC60950_1C_II
Attachment Originator	SGS Fimko Ltd
Master Attachment	Date 2011-08
Copyright © 2011 IEC System for Conformity Testing and Certification of Electrical Equipment (IECEE), Geneva, Switzerland. All rights reserved.	

EN 60950-1:2006/A11:2009/A1:2010/A12:2011 – CENELEC COMMON MODIFICATIONS
--

IEC 60950-1, GROUP DIFFERENCES (CENELEC common modifications EN)		
Contents	Add the following annexes: Annex ZA (normative) Normative references to international publications with their corresponding European publications Annex ZB (normative) Special national conditions	P
General	Delete all the “country” notes in the reference document (IEC 60950-1:2005) according to the following list: 1.4.8 Note 2 1.5.1 Note 2 & 3 1.5.7.1 Note 1.5.8 Note 2 1.5.9.4 Note 1.7.2.1 Note 4, 5 & 6 2.2.3 Note 2.2.4 Note 2.3.2 Note 2.3.2.1 Note 2 2.3.4 Note 2 2.6.3.3 Note 2 & 3 2.7.1 Note 2.10.3.2 Note 2 2.10.5.13 Note 3 3.2.1.1 Note 3.2.4 Note 3. 2.5.1 Note 2 4.3.6 Note 1 & 2 4.7 Note 4 4.7.2.2 Note 4.7.3.1 Note 2 5.1.7.1 Note 3 & 4 5.3.7 Note 1 6 Note 2 & 5 6.1.2.1 Note 2 6.1.2.2 Note 6.2.2 Note 6.2.2.1 Note 2 6.2.2.2 Note 7.1 Note 3 7.2 Note 7.3 Note 1 & 2 G.2.1 Note 2 Annex H Note 2	P
General (A1:2010)	Delete all the “country” notes in the reference document (IEC 60950-1:2005/A1:2010) according to the following list: 1.5.7.1 Note 6.1.2.1 Note 2 6.2.2.1 Note 2 EE.3 Note	P

IEC60950_1C - ATTACHMENT			
Clause	Requirement + Test	Result - Remark	Verdict
1.3.Z1	<p>Add the following subclause:</p> <p>1.3.Z1 Exposure to excessive sound pressure</p> <p>The apparatus shall be so designed and constructed as to present no danger when used for its intended purpose, either in normal operating conditions or under fault conditions, particularly providing protection against exposure to excessive sound pressures from headphones or earphones.</p> <p>NOTE Z1 A new method of measurement is described in EN 50332-1, Sound system equipment: Headphones and earphones associated with portable audio equipment - Maximum sound pressure level measurement methodology and limit considerations - Part 1: General method for "one package equipment", and in EN 50332-2, Sound system equipment: Headphones and earphones associated with portable audio equipment - Maximum sound pressure level measurement methodology and limit considerations - Part 2: Guidelines to associate sets with headphones coming from different manufacturers.</p>	Added.	N/A
(A12:2011)	<p>In EN 60950-1:2006/A12:2011</p> <p>Delete the addition of 1.3.Z1 / EN 60950-1:2006</p> <p>Delete the definition 1.2.3.Z1 / EN 60950-1:2006 /A1:2010</p>	Deleted.	N/A
1.5.1	<p>Add the following NOTE:</p> <p>NOTE Z1 The use of certain substances in electrical and electronic equipment is restricted within the EU: see Directive 2002/95/EC</p>	Added.	P
1.7.2.1 (A1:2010)	<p>In addition, for a PORTABLE SOUND SYSTEM, the instructions shall include a warning that excessive sound pressure from earphones and headphones can cause hearing loss.</p>	Added.	N/A
1.7.2.1 (A12.2011)	<p>In EN 60950-1:2006/A12:2011</p> <p>Delete NOTE Z1 and the addition for Portable Sound System.</p> <p>Add the following clause and annex to the existing standard and amendments.</p>		N/A
	<p>Zx Protection against excessive sound pressure from personal music players</p>		N/A

IEC60950_1C - ATTACHMENT			
Clause	Requirement + Test	Result - Remark	Verdict
	<p>Zx.1 General</p> <p>This sub-clause specifies requirements for protection against excessive sound pressure from personal music players that are closely coupled to the ear. It also specifies requirements for earphones and headphones intended for use with personal music players.</p> <p>A personal music player is a portable equipment□ for personal use, that:</p> <ul style="list-style-type: none"> – is designed to allow the user to listen to recorded or broadcast sound or video; and – primarily uses headphones or earphones that can be worn in or on or around the ears; and – allows the user to walk around while in use. <p>NOTE 1 Examples are hand-held or body-worn portable CD players, MP3 audio players, mobile phones with MP3 type features, PDA's or similar equipment.</p> <p>A personal music player and earphones or headphones intended to be used with personal music players shall comply with the requirements of this sub-clause.</p> <p>The requirements in this sub-clause are valid for music or video mode only.</p> <p>The requirements do not apply:</p> <ul style="list-style-type: none"> – while the personal music player is connected to an external amplifier; or – while the headphones or earphones are not used. <p>NOTE 2 An external amplifier is an amplifier which is not part of the personal music player or the listening device, but which is intended to play the music as a standalone music player.</p> <p>The requirements do not apply to:</p> <ul style="list-style-type: none"> – hearing aid equipment and professional equipment; <p>NOTE 3 Professional equipment is equipment sold through special sales channels. All products sold through normal electronics stores are considered not to be professional equipment.</p>	Not personal music player	N/A

IEC60950_1C - ATTACHMENT			
Clause	Requirement + Test	Result - Remark	Verdict
	<p>– analogue personal music players (personal music players without any kind of digital processing of the sound signal) that are brought to the market before the end of 2015.</p> <p>NOTE 4 This exemption has been allowed because this technology is falling out of use and it is expected that within a few years it will no longer exist. This exemption will not be extended to other technologies.</p> <p>For equipment which is clearly designed or intended for use by young children, the limits of EN 71-1 apply.</p>		
	<p>Zx.2 Equipment requirements</p> <p>No safety provision is required for equipment that complies with the following:</p> <ul style="list-style-type: none"> – equipment provided as a package (personal music player with its listening device), where the acoustic output $L_{Aeq,T}$ is ≤ 85 dBA measured while playing the fixed “programme simulation noise” as described in EN 50332-1; and – a personal music player provided with an analogue electrical output socket for a listening device, where the electrical output is ≤ 27 mV measured as described in EN 50332-2, while playing the fixed “programme simulation noise” as described in EN 50332-1. <p>NOTE 1 Wherever the term acoustic output is used in this clause, the 30 s A-weighted equivalent sound pressure level $L_{Aeq,T}$ is meant. See also Zx.5 and Annex Zx.</p> <p>All other equipment shall:</p> <ol style="list-style-type: none"> a) protect the user from unintentional acoustic outputs exceeding those mentioned above; and b) have a standard acoustic output level not exceeding those mentioned above, and automatically return to an output level not exceeding those mentioned above when the power is switched off; and 		N/A

IEC60950_1C - ATTACHMENT			
Clause	Requirement + Test	Result - Remark	Verdict
	<p>c) provide a means to actively inform the user of the increased sound pressure when the equipment is operated with an acoustic output exceeding those mentioned above. Any means used shall be acknowledged by the user before activating a mode of operation which allows for an acoustic output exceeding those mentioned above. The acknowledgement does not need to be repeated more than once every 20 h of cumulative listening time; and</p> <p>NOTE 2 Examples of means include visual or audible signals. Action from the user is always required.</p> <p>NOTE 3 The 20 h listening time is the accumulative listening time, independent how often and how long the personal music player has been switched off.</p> <p>d) have a warning as specified in Zx.3; and</p> <p>e) not exceed the following:</p> <ol style="list-style-type: none"> 1) equipment provided as a package (player with its listening device), the acoustic output shall be ≤ 100 dBA measured while playing the fixed "programme simulation noise" described in EN 50332-1; and 2) a personal music player provided with an analogue electrical output socket for a listening device, the electrical output shall be ≤ 150 mV measured as described in EN 50332-2, while playing the fixed "programme simulation noise" described in EN 50332-1. <p>For music where the average sound pressure (long term $L_{Aeq,T}$) measured over the duration of the song is lower than the average produced by the programme simulation noise, the warning does not need to be given as long as the average sound pressure of the song is below the basic limit of 85 dBA. In this case T becomes the duration of the song.</p> <p>NOTE 4 Classical music typically has an average sound pressure (long term $L_{Aeq,T}$) which is much lower than the average programme simulation noise. Therefore, if the player is capable to analyse the song and compare it with the programme simulation noise, the warning does not need to be given as long as the average sound pressure of the song is below the basic limit of 85 dBA.</p> <p>For example, if the player is set with the programme simulation noise to 85 dBA, but the average music level of the song is only 65 dBA, there is no need to give a warning or ask an acknowledgement as long as the average sound level of the song is not above the basic limit of 85 dBA.</p>		N/A

IEC60950_1C - ATTACHMENT			
Clause	Requirement + Test	Result - Remark	Verdict
	<p>Zx.3 Warning</p> <p>The warning shall be placed on the equipment, or on the packaging, or in the instruction manual and shall consist of the following:</p> <ul style="list-style-type: none"> – the symbol of Figure 1 with a minimum height of 5 mm; and – the following wording, or similar: <p>“To prevent possible hearing damage, do not listen at high volume levels for long periods.”</p> <div style="text-align: center;">  </div> <p>Figure 1 – Warning label (IEC 60417-6044)</p> <p>Alternatively, the entire warning may be given through the equipment display during use, when the user is asked to acknowledge activation of the higher level.</p>		N/A
	<p>Zx.4 Requirements for listening devices (headphones and earphones)</p>		N/A
	<p>Zx.4.1 Wired listening devices with analogue input</p> <p>With 94 dBA sound pressure output $L_{Aeq,T}$, the input voltage of the fixed “programme simulation noise” described in EN 50332-2 shall be ≥ 75 mV.</p> <p>This requirement is applicable in any mode where the headphones can operate (active or passive), including any available setting (for example built-in volume level control).</p> <p>NOTE The values of 94 dBA – 75 mV correspond with 85dBA – 27 mV and 100 dBA – 150 mV.</p>		N/A

IEC60950_1C - ATTACHMENT			
Clause	Requirement + Test	Result - Remark	Verdict
	<p>Zx.4.2 Wired listening devices with digital input</p> <p>With any playing device playing the fixed “programme simulation noise” described in EN 50332-1 (and respecting the digital interface standards, where a digital interface standard exists that specifies the equivalent acoustic level), the acoustic output $L_{Aeq,T}$ of the listening device shall be ≤ 100 dBA.</p> <p>This requirement is applicable in any mode where the headphones can operate, including any available setting (for example built-in volume level control, additional sound feature like equalization, etc.).</p> <p>NOTE An example of a wired listening device with digital input is a USB headphone.</p>		N/A
	<p>Zx.4.3 Wireless listening devices</p> <p>In wireless mode:</p> <ul style="list-style-type: none"> – with any playing and transmitting device playing the fixed programme simulation noise described in EN 50332-1; and – respecting the wireless transmission standards, where an air interface standard exists that specifies the equivalent acoustic level; and – with volume and sound settings in the listening device (for example built-in volume level control, additional sound feature like equalization, etc.) set to the combination of positions that maximize the measured acoustic output for the abovementioned programme simulation noise, the acoustic output $L_{Aeq,T}$ of the listening device shall be ≤ 100 dBA. <p>NOTE An example of a wireless listening device is a Bluetooth headphone.</p>		N/A
	<p>Zx.5 Measurement methods</p> <p>Measurements shall be made in accordance with EN 50332-1 or EN 50332-2 as applicable. Unless stated otherwise, the time interval T shall be 30 s.</p> <p>NOTE Test method for wireless equipment provided without listening device should be defined.</p>		N/A

IEC60950_1C - ATTACHMENT									
Clause	Requirement + Test	Result - Remark	Verdict						
2.7.1	<p>Replace the subclause as follows:</p> <p>Basic requirements</p> <p>To protect against excessive current, short-circuits and earth faults in PRIMARY CIRCUITS, protective devices shall be included either as integral parts of the equipment or as parts of the building installation, subject to the following, a), b) and c):</p> <p>a) except as detailed in b) and c), protective devices necessary to comply with the requirements of 5.3 shall be included as parts of the equipment;</p> <p>b) for components in series with the mains input to the equipment such as the supply cord, appliance coupler, r.f.i. filter and switch, short-circuit and earth fault protection may be provided by protective devices in the building installation;</p>	Replaced.	P						
	<p>c) it is permitted for PLUGGABLE EQUIPMENT TYPE B or PERMANENTLY CONNECTED EQUIPMENT, to rely on dedicated overcurrent and short-circuit protection in the building installation, provided that the means of protection, e.g. fuses or circuit breakers, is fully specified in the installation instructions.</p> <p>If reliance is placed on protection in the building installation, the installation instructions shall so state, except that for PLUGGABLE EQUIPMENT TYPE A the building installation shall be regarded as providing protection in accordance with the rating of the wall socket outlet.</p>		P						
2.7.2	This subclause has been declared 'void'.		N/A						
3.2.3	Delete the NOTE in Table 3A, and delete also in this table the conduit sizes in parentheses.		N/A						
3.2.5.1	<p>Replace "60245 IEC 53" by "H05 RR-F";</p> <p>"60227 IEC 52" by "H03 VV-F or H03 VVH2-F";</p> <p>"60227 IEC 53" by "H05 VV-F or H05 VVH2-F2".</p> <p>In Table 3B, replace the first four lines by the following:</p> <table border="0"> <tr> <td>Up to and including 6 </td> <td>0,75^{a)} </td> </tr> <tr> <td>Over 6 up to and including 10 </td> <td>(0,75)^{b)} 1,0 </td> </tr> <tr> <td>Over 10 up to and including 16 </td> <td>(1,0)^{c)} 1,5 </td> </tr> </table> <p>In the conditions applicable to Table 3B delete the words "in some countries" in condition^{a)}.</p> <p>In NOTE 1, applicable to Table 3B, delete the second sentence.</p>	Up to and including 6	0,75 ^{a)}	Over 6 up to and including 10	(0,75) ^{b)} 1,0	Over 10 up to and including 16	(1,0) ^{c)} 1,5		N/A
Up to and including 6	0,75 ^{a)}								
Over 6 up to and including 10	(0,75) ^{b)} 1,0								
Over 10 up to and including 16	(1,0) ^{c)} 1,5								

IEC60950_1C - ATTACHMENT			
Clause	Requirement + Test	Result - Remark	Verdict
3.3.4	In Table 3D, delete the fourth line: conductor sizes for 10 to 13 A, and replace with the following: Over 10 up to and including 16 1,5 to 2,5 1,5 to 4 Delete the fifth line: conductor sizes for 13 to 16 A		N/A
4.3.13.6 (A1:2010)	Replace the existing NOTE by the following: NOTE Z1 Attention is drawn to: 1999/519/EC: Council Recommendation on the limitation of exposure of the general public to electromagnetic fields 0 Hz to 300 GHz, and 2006/25/EC: Directive on the minimum health and safety requirements regarding the exposure of workers to risks arising from physical agents (artificial optical radiation).		N/A
	Standards taking into account mentioned Recommendation and Directive which demonstrate compliance with the applicable EU Directive are indicated in the OJEC.		N/A
Annex H	Replace the last paragraph of this annex by: At any point 10 cm from the surface of the OPERATOR ACCESS AREA, the dose rate shall not exceed 1 µSv/h (0,1 mR/h) (see NOTE). Account is taken of the background level. Replace the notes as follows: NOTE These values appear in Directive 96/29/Euratom. Delete NOTE 2.		N/A
Bibliography	Additional EN standards.		—

ZA	NORMATIVE REFERENCES TO INTERNATIONAL PUBLICATIONS WITH THEIR CORRESPONDING EUROPEAN PUBLICATIONS	—
-----------	--	---

ZB ANNEX (normative) SPECIAL NATIONAL CONDITIONS (EN)			
Clause	Requirement + Test	Result - Remark	Verdict
1.2.4.1	In Denmark , certain types of Class I appliances (see 3.2.1.1) may be provided with a plug not establishing earthing conditions when inserted into Danish socket-outlets.		N/A
1.2.13.14	In Norway and Sweden , for requirements see 1.7.2.1 and 7.3 of this annex.		N/A

IEC60950_1C - ATTACHMENT			
Clause	Requirement + Test	Result - Remark	Verdict
1.5.7.1	In Finland, Norway and Sweden , resistors bridging BASIC INSULATION in CLASS I PLUGGABLE EQUIPMENT TYPE A must comply with the requirements in 1.5.7.1. In addition when a single resistor is used, the resistor must withstand the resistor test in 1.5.7.2.		N/A
1.5.8	In Norway , due to the IT power system used (see annex V, Figure V.7), capacitors are required to be rated for the applicable line-to-line voltage (230 V).		P
1.5.9.4	In Finland, Norway and Sweden , the third dashed sentence is applicable only to equipment as defined in 6.1.2.2 of this annex.		N/A

IEC60950_1C - ATTACHMENT			
Clause	Requirement + Test	Result - Remark	Verdict
1.7.2.1	<p>In Finland, Norway and Sweden, CLASS I PLUGGABLE EQUIPMENT TYPE A intended for connection to other equipment or a network shall, if safety relies on connection to protective earth or if surge suppressors are connected between the network terminals and accessible parts, have a marking stating that the equipment must be connected to an earthed mains socket-outlet. The marking text in the applicable countries shall be as follows:</p> <p>In Finland: "Laite on liitettävä suojakoskettimilla varustettuun pistorasiaan"</p> <p>In Norway: "Apparatet må tilkoples jordet stikkontakt"</p> <p>In Sweden: "Apparaten skall anslutas till jordat uttag"</p> <p>In Norway and Sweden, the screen of the cable distribution system is normally not earthed at the entrance of the building and there is normally no equipotential bonding system within the building. Therefore the protective earthing of the building installation need to be isolated from the screen of a cable distribution system.</p> <p>It is however accepted to provide the insulation external to the equipment by an adapter or an interconnection cable with galvanic isolator, which may be provided by e.g. a retailer.</p> <p>The user manual shall then have the following or similar information in Norwegian and Swedish language respectively, depending on in what country the equipment is intended to be used in:</p> <p>"Equipment connected to the protective earthing of the building installation through the mains connection or through other equipment with a connection to protective earthing – and to a cable distribution system using coaxial cable, may in some circumstances create a fire hazard. Connection to a cable distribution system has therefore to be provided through a device providing electrical isolation below a certain frequency range (galvanic isolator, see EN 60728-11)."</p>		N/A

IEC60950_1C - ATTACHMENT			
Clause	Requirement + Test	Result - Remark	Verdict
	<p>NOTE In Norway, due to regulation for installations of cable distribution systems, and in Sweden, a galvanic isolator shall provide electrical insulation below 5 MHz. The insulation shall withstand a dielectric strength of 1,5 kV r.m.s., 50 Hz or 60 Hz, for 1 min.</p> <p>Translation to Norwegian (the Swedish text will also be accepted in Norway): "Utstyr som er koplet til beskyttelsesjord via nettplugg og/eller via annet jordtilkoplede utstyr – og er tilkoplede et kabel-TV nett, kan forårsake brannfare. For å unngå dette skal det ved tilkoplede av utstyret til kabel-TV nettet installeres en galvanisk isolator mellom utstyret og kabel-TV nettet." Translation to Swedish: "Utrustning som är kopplad till skyddsjord via jordat vägguttag och/eller via annan utrustning och samtidigt är kopplad till kabel-TV nät kan i vissa fall medföra risk för brand. För att undvika detta skall vid anslutning av utrustningen till kabel-TV nät galvanisk isolator finnas mellan utrustningen och kabel-TV nätet."</p>		
1.7.5	<p>In Denmark, socket-outlets for providing power to other equipment shall be in accordance with the Heavy Current Regulations, Section 107-2-D1, Standard Sheet DK 1-3a, DK 1-5a or DK 1-7a, when used on Class I equipment. For STATIONARY EQUIPMENT the socket-outlet shall be in accordance with Standard Sheet DK 1-1b or DK 1-5a.</p> <p>For CLASS II EQUIPMENT the socket outlet shall be in accordance with Standard Sheet DKA 1-4a.</p>		N/A
2.2.4	In Norway , for requirements see 1.7.2.1, 6.1.2.1 and 6.1.2.2 of this annex.		N/A
2.3.2	In Finland, Norway and Sweden there are additional requirements for the insulation. See 6.1.2.1 and 6.1.2.2 of this annex.		N/A
2.3.4	In Norway , for requirements see 1.7.2.1, 6.1.2.1 and 6.1.2.2 of this annex.		N/A
2.6.3.3	In the United Kingdom , the current rating of the circuit shall be taken as 13 A, not 16 A.		P
2.7.1	In the United Kingdom , to protect against excessive currents and short-circuits in the PRIMARY CIRCUIT of DIRECT PLUG-IN EQUIPMENT, tests according to 5.3 shall be conducted, using an external protective device rated 30 A or 32 A. If these tests fail, suitable protective devices shall be included as integral parts of the DIRECT PLUG-IN EQUIPMENT, so that the requirements of 5.3 are met.		N/A

IEC60950_1C - ATTACHMENT			
Clause	Requirement + Test	Result - Remark	Verdict
2.10.5.13	In Finland, Norway and Sweden , there are additional requirements for the insulation, see 6.1.2.1 and 6.1.2.2 of this annex.		N/A
3.2.1.1	<p>In Switzerland, supply cords of equipment having a RATED CURRENT not exceeding 10 A shall be provided with a plug complying with SEV 1011 or IEC 60884-1 and one of the following dimension sheets:</p> <p>SEV 6532-2.1991 Plug Type 15 3P+N+PE 250/400 V, 10 A</p> <p>SEV 6533-2.1991 Plug Type 11 L+N 250 V, 10 A</p> <p>SEV 6534-2.1991 Plug Type 12 L+N+PE 250 V, 10 A</p> <p>In general, EN 60309 applies for plugs for currents exceeding 10 A. However, a 16 A plug and socket-outlet system is being introduced in Switzerland, the plugs of which are according to the following dimension sheets, published in February 1998:</p> <p>SEV 5932-2.1998: Plug Type 25 , 3L+N+PE 230/400 V, 16 A</p> <p>SEV 5933-2.1998: Plug Type 21, L+N, 250 V, 16A</p> <p>SEV 5934-2.1998: Plug Type 23, L+N+PE 250 V,</p>		N/A
3.2.1.1	<p>In Denmark, supply cords of single-phase equipment having a rated current not exceeding 13 A shall be provided with a plug according to the Heavy Current Regulations, Section 107-2-D1.</p> <p>CLASS I EQUIPMENT provided with socket-outlets with earth contacts or which are intended to be used in locations where protection against indirect contact is required according to the wiring rules shall be provided with a plug in accordance with standard sheet DK 2-1a or DK 2-5a.</p> <p>If poly-phase equipment and single-phase equipment having a RATED CURRENT exceeding 13 A is provided with a supply cord with a plug, this plug shall be in accordance with the Heavy Current Regulations, Section 107-2-D1 or EN 60309-2.</p>		N/A

IEC60950_1C - ATTACHMENT			
Clause	Requirement + Test	Result - Remark	Verdict
3.2.1.1	<p>In Spain, supply cords of single-phase equipment having a rated current not exceeding 10 A shall be provided with a plug according to UNE 20315:1994.</p> <p>Supply cords of single-phase equipment having a rated current not exceeding 2,5 A shall be provided with a plug according to UNE-EN 50075:1993.</p> <p>CLASS I EQUIPMENT provided with socket-outlets with earth contacts or which are intended to be used in locations where protection against indirect contact is required according to the wiring rules, shall be provided with a plug in accordance with standard UNE 20315:1994.</p> <p>If poly-phase equipment is provided with a supply cord with a plug, this plug shall be in accordance with UNE-EN 60309-2.</p>		N/A
3.2.1.1	<p>In the United Kingdom, apparatus which is fitted with a flexible cable or cord and is designed to be connected to a mains socket conforming to BS 1363 by means of that flexible cable or cord and plug, shall be fitted with a 'standard plug' in accordance with Statutory Instrument 1768:1994 - The Plugs and Sockets etc. (Safety) Regulations 1994, unless exempted by those regulations.</p> <p>NOTE 'Standard plug' is defined in SI 1768:1994 and essentially means an approved plug conforming to BS 1363 or an approved conversion plug.</p>		N/A
3.2.1.1	<p>In Ireland, apparatus which is fitted with a flexible cable or cord and is designed to be connected to a mains socket conforming to I.S. 411 by means of that flexible cable or cord and plug, shall be fitted with a 13 A plug in accordance with Statutory Instrument 525:1997 - National Standards Authority of Ireland (section 28) (13 A Plugs and Conversion Adaptors for Domestic Use) Regulations 1997.</p>		N/A
3.2.4	<p>In Switzerland, for requirements see 3.2.1.1 of this annex.</p>		N/A
3.2.5.1	<p>In the United Kingdom, a power supply cord with conductor of 1,25 mm² is allowed for equipment with a rated current over 10 A and up to and including 13 A.</p>		N/A
3.3.4	<p>In the United Kingdom, the range of conductor sizes of flexible cords to be accepted by terminals for equipment with a RATED CURRENT of over 10 A up to and including 13 A is:</p> <ul style="list-style-type: none"> • 1,25 mm² to 1,5 mm² nominal cross-sectional area. 		N/A

IEC60950_1C - ATTACHMENT			
Clause	Requirement + Test	Result - Remark	Verdict
4.3.6	In the United Kingdom , the torque test is performed using a socket outlet complying with BS 1363 part 1:1995, including Amendment 1:1997 and Amendment 2:2003 and the plug part of DIRECT PLUG-IN EQUIPMENT shall be assessed to BS 1363: Part 1, 12.1, 12.2, 12.3, 12.9, 12.11, 12.12, 12.13, 12.16 and 12.17, except that the test of 12.17 is performed at not less than 125 °C. Where the metal earth pin is replaced by an Insulated Shutter Opening Device (ISOD), the requirements of clauses 22.2 and 23 also apply.		N/A
4.3.6	In Ireland , DIRECT PLUG-IN EQUIPMENT is known as plug similar devices. Such devices shall comply with Statutory Instrument 526:1997 - National Standards Authority of Ireland (Section 28) (Electrical plugs, plug similar devices and sockets for domestic use) Regulations, 1997.		N/A
5.1.7.1	In Finland, Norway and Sweden TOUCH CURRENT measurement results exceeding 3,5 mA r.m.s. are permitted only for the following equipment: <ul style="list-style-type: none"> • STATIONARY PLUGGABLE EQUIPMENT TYPE A that <ul style="list-style-type: none"> is intended to be used in a RESTRICTED ACCESS LOCATION where equipotential bonding has been applied, for example, in a telecommunication centre; and has provision for a permanently connected PROTECTIVE EARTHING CONDUCTOR; and is provided with instructions for the installation of that conductor by a SERVICE PERSON; • STATIONARY PLUGGABLE EQUIPMENT TYPE B; • STATIONARY PERMANENTLY CONNECTED EQUIPMENT. 		N/A

IEC60950_1C - ATTACHMENT			
Clause	Requirement + Test	Result - Remark	Verdict
6.1.2.1 (A1:2010)	<p>In Finland, Norway and Sweden, add the following text between the first and second paragraph of the compliance clause:</p> <p>If this insulation is solid, including insulation forming part of a component, it shall at least consist of either</p> <ul style="list-style-type: none"> - two layers of thin sheet material, each of which shall pass the electric strength test below, or - one layer having a distance through insulation of at least 0,4 mm, which shall pass the electric strength test below. <p>Alternatively for components, there is no distance through insulation requirements for the insulation consisting of an insulating compound completely filling the casing, so that CLEARANCES and CREEPAGE DISTANCES do not exist, if the component passes the electric strength test in accordance with the compliance clause below and in addition</p> <ul style="list-style-type: none"> - passes the tests and inspection criteria of 2.10.11 with an electric strength test of 1,5 kV multiplied by 1,6 (the electric strength test of 2.10.10 shall be performed using 1,5 kV), and - is subject to ROUTINE TESTING for electric strength during manufacturing, using a test voltage of 1,5 kV. 		N/A
	<p>It is permitted to bridge this insulation with an optocoupler complying with 2.10.5.4 b).</p> <p>It is permitted to bridge this insulation with a capacitor complying with EN 60384-14:2005, subclass Y2.</p> <p>A capacitor classified Y3 according to EN 60384-14:2005, may bridge this insulation under the following conditions:</p> <ul style="list-style-type: none"> - the insulation requirements are satisfied by having a capacitor classified Y3 as defined by EN 60384-14, which in addition to the Y3 testing, is tested with an impulse test of 2,5 kV defined in EN 60950-1:2006, 6.2.2.1; - the additional testing shall be performed on all the test specimens as described in EN 60384-14; - the impulse test of 2,5 kV is to be performed before the endurance test in EN 60384-14, in the sequence of tests as described in EN 60384-14. 		N/A

IEC60950_1C - ATTACHMENT			
Clause	Requirement + Test	Result - Remark	Verdict
6.1.2.2	In Finland, Norway and Sweden , the exclusions are applicable for PERMANENTLY CONNECTED EQUIPMENT, PLUGGABLE EQUIPMENT TYPE B and equipment intended to be used in a RESTRICTED ACCESS LOCATION where equipotential bonding has been applied, e.g. in a telecommunication centre, and which has provision for a permanently connected PROTECTIVE EARTHING CONDUCTOR and is provided with instructions for the installation of that conductor by a SERVICE PERSON.		N/A
7.2	In Finland, Norway and Sweden , for requirements see 6.1.2.1 and 6.1.2.2 of this annex. The term TELECOMMUNICATION NETWORK in 6.1.2 being replaced by the term CABLE DISTRIBUTION SYSTEM.		N/A
7.3	In Norway and Sweden , for requirements see 1.2.13.14 and 1.7.2.1 of this annex.		N/A
7.3	In Norway , for installation conditions see EN 60728-11:2005.		N/A

IEC60950_1C - ATTACHMENT			
Clause	Requirement + Test	Result - Remark	Verdict

**ATTACHMENT TO TEST REPORT IEC 60950-1
CANADA NATIONAL DIFFERENCES**

Information technology equipment – Safety –

Part 1: General requirements

Differences according to.....: CAN/CSA-C22.2 NO. 60950-1A-07

Attachment Form No.: CA_ND_IEC60950_1C

Attachment Originator: TÜV SÜD Product Service GmbH

Master Attachment: Date (2012-08)

Copyright © 2012 IEC System for Conformity Testing and Certification of Electrical Equipment (IECEE), Geneva, Switzerland. All rights reserved.

	Special national conditions		
1.1.1	All equipment is to be designed to allow installation in accordance with the National Electrical Code (NEC), ANSI/NFPA 70, the Canadian Electrical Code (CEC), Part I, CAN/CSA C22.1, and when applicable, the National Electrical Safety Code, IEEE C2.	In accordance with the National Electrical Code (NEC), ANSI/NFPA 70, and unless marked or otherwise identified, the Standard for Electronic Computer/Data-Processing Equipment, ANSI/NFPA 75.	P
	Also, unless marked or otherwise identified, installation is allowed per the Standard for the Protection of Electronic Computer/Data-Processing Equipment, ANSI/NFPA 75.		P
1.4.14	For Pluggable Equipment Type A, the protection in the installation is assumed to be 20A.	Considered.	P
1.5.5	For lengths exceeding 3.05 m, external interconnecting flexible cord and cable assemblies are required to be a suitable cable type (e.g., DP, CL2) specified in the CEC/NEC.	No external cable provided.	N/A
	For lengths 3.05 m or less, external interconnecting flexible cord and cable assemblies that are not types specified in the CEC are required to have special construction features and identification markings.		N/A
1.7.1	Equipment for use on a.c. mains supply systems with a neutral and more than one phase conductor (e.g. 120/240 V, 3-wire) require a special marking format for electrical ratings.	Single-phase equipment.	N/A
	A voltage rating that exceeds an attachment plug cap rating is only permitted if it does not exceed the extreme operating conditions in Table 2 of CAN/CSA C22.2 No. 235, and		N/A
	- if it is part of a range that extends into the Table 2 "Normal Operating Conditions."		N/A

IEC60950_1C - ATTACHMENT			
Clause	Requirement + Test	Result - Remark	Verdict
	A voltage rating is not be lower than the specified "Normal Operating Conditions," unless it is part of a range that extends into the "Normal Operating Conditions."		N/A
1.7.7	Wiring terminals intended to supply Class 2 outputs in accordance with CEC Part 1 or NEC are marked with the voltage rating and "Class 2" or equivalent.	No wiring terminals.	N/A
	- Marking is located adjacent to the terminals		N/A
	- Marking is visible during wiring		N/A
2.5	Fuse providing Class 2, Limited Power Source, or TNV current limiting is not operator-accessible unless it is not interchangeable.	Not operator-accessible.	P
2.6.3.3	Modify first column on Table 2D to "Smaller of the RATED CURRENT of the equipment or the PROTECTIVE CURRENT RATING of the circuit under consideration."	Considered.	P
2.7.1	Suitable NEC/CEC branch circuit protection rated at the maximum circuit rating is provided for all standard supply outlets and receptacles (such as supplied in power distribution units) if the supply branch circuit protection is not suitable.	No such components provided.	N/A
	Power distribution transformers distributing power at 100 volts or more, and rated 10 kVA or more, provided with special transformer overcurrent protection.		N/A
3.2	Wiring methods (terminals, leads, etc.) used for the connection of the equipment to the mains is in accordance with the NEC/CEC.		N/A
3.2.1	Attachment plugs of power supply cords are rated not less than 125 percent of the rated current of the equipment.	No power supply cord provided.	N/A
3.2.1.2	Equipment connected to a centralized d.c. power system, and having one pole of the DC mains input terminal connected to the main protective earthing terminal in the equipment comply with special earthing, wiring, marking and installation instruction requirements.	No connection to a centralized d.c. power system.	N/A
3.2.3	Permanent connection of equipment to the mains supply by a power supply cord is not permitted, except for certain equipment, such as ATMs.	Pluggable equipment type A.	N/A
3.2.5	Power supply cords are no longer than 4.5 m in length.	No power supply cord provided.	N/A
	Minimum cord length is 1.5 m, with certain constructions such as external power supplies allowed to consider both input and output cord lengths into the requirement.		N/A

IEC60950_1C - ATTACHMENT			
Clause	Requirement + Test	Result - Remark	Verdict
	Flexible power supply cords are compatible with Article 400 of the NEC, and Tables 11 and 12 of the CEC.		N/A
3.2.9	Permanently connected equipment have a suitable wiring compartment and wire bending space.	Pluggable equipment type A.	N/A
3.3	Wiring terminals and associated spacings for field wiring connections comply with CSA C22.2 No. 0.	No wiring terminals.	N/A
3.3.3	Wire binding screws are not permitted to attach conductors larger than 10 AWG (5.3 mm ²).	No wire binding screws.	N/A
3.3.4	Terminals for permanent wiring, including protective earthing terminals, are suitable for Canadian/US wire gauge sizes, are	Pluggable equipment type A.	N/A
	- rated 125 percent of the equipment rating, and		N/A
	- are specially marked when specified (1.7.7).		N/A
3.3.5	Revise first column of Table 3E to "Smaller of the RATED CURRENT of the equipment or the PROTECTIVE CURRENT RATING of the circuit under consideration."	Considered.	N/A
3.4.2	Motor control devices are provided for cord-connected equipment with a motor if the equipment is rated more than 12 A,	Equipment is not such a device.	N/A
	- or if the motor has a nominal voltage rating greater than 120 V		N/A
	- or is rated more than 1/3 hp (locked rotor current over 43 A)		N/A
3.4.8	Vertically-mounted disconnect switches and circuit breakers have the "on" position indicated by the handle in the up position.	No such devices incorporated.	N/A
3.4.11	For computer room applications, equipment with battery systems capable of supplying 750 VA for five minutes have a battery disconnect means that may be connected to the computer room remote power-off circuit.	Not such an application.	N/A
4.3.12	The maximum quantity of flammable liquid stored in equipment complies with NFPA 30.	No liquids.	N/A
4.3.13.5	Equipment with lasers meet the Canadian Radiation Emitting Devices Act, REDR C1370 and/or Code of Federal Regulations 21 CFR 1040, as applicable.	No lasers.	N/A
4.7	For computer room applications, automated information storage systems with combustible media greater than 0.76 m ³ (27 cu ft) have a provision for connection of either automatic sprinklers or a gaseous agent extinguishing system with an extended discharge.	Not such an application.	N/A

IEC60950_1C - ATTACHMENT			
Clause	Requirement + Test	Result - Remark	Verdict
4.7.3.1	For computer room applications, enclosures with combustible material measuring greater than 0.9 m ² (10 sq ft) or a single dimension greater than 1.8 m (6 ft) have a flame spread rating of 50 or less.	Not such an application.	N/A
	For other applications, enclosures with the same dimensions require a flame spread rating of 200 or less.		N/A
Annex H	Equipment that produces ionizing radiation comply with the Canadian Radiation Emitting Devices Act, REDR C1370 and/or Code of Federal Regulations, 21 CFR 1020, as applicable.	Equipment is not such a device.	N/A
	Other National Differences		
1.5.1	Some components and materials associated with the risk of fire, electric shock, or personal injury have component or material ratings in accordance with the applicable national (Canadian and/or U.S.) component or material standard requirements.	Complied. See table 1.5.1	P
1.6.1.2	A circuit for connection to the DC Mains Supply is classified as either a SELV Circuit, TNV-2 Circuit or Hazardous Voltage Circuit depending on the maximum operating voltage of the supply.	No connection to the DC Mains Supply.	N/A
	This maximum operating voltage includes consideration of the battery charging "float voltage" associated with the intended supply system, regardless of the marked power rating of the equipment.		N/A
2.3.1	For TNV-2 and TNV-3 circuits with other than ringing signals and with voltages exceeding 42.4 V _{peak} or 60 V _{d.c.} , the maximum acceptable current through a 2000 ohm resistor (or greater) connected across the voltage source with other loads disconnected is 7.1 mA peak or 30 mA d.c. under normal operating conditions.	No TNV circuits.	N/A
2.3.2.1	In the event of a single fault between TNV and SELV circuits, the limits of 2.2.3 apply to SELV Circuits and accessible conductive parts.	No TNV circuits.	N/A
2.6.3.4	Protective bonding conductors of non-standard protective bonding constructions (e.g., printed circuit traces) may be subjected to the additional limited short circuit test conditions specified.		P
4.2.8.1	Enclosures around CRTs with a face diameter of 160 mm or more reduce the risk of injury due to the implosion of the CRT.	No CRTs.	N/A
4.3.2	Equipment with handles complies with special loading tests.	No handles.	N/A
5.1.8.3	Equipment intended to receive telecommunication ringing signals comply with a special touch current measurement tests.	No TNV	N/A

IEC60950_1C - ATTACHMENT			
Clause	Requirement + Test	Result - Remark	Verdict
5.3.7	Internal (e.g., card cage) SELV circuit connectors and printed wiring board connectors that are accessible to the operator and that deliver power are overloaded.		N/A
	During abnormal operating testing, if a circuit is interrupted by the opening of a component, the test shall be repeated twice (three tests total) using new components as necessary		N/A
6.4	Equipment intended for connection to telecommunication network outside plant cable is protected against overvoltage from power line crosses in accordance with 6.4 and Annex NAC.	No TNV.	N/A
Annex EE	Articulated accessibility probe (Fig EE.3) is used for assessing accessibility to document/media shredders instead of the Figure 2A test finger.	Equipment is not such a device.	N/A
M.2	Continuous ringing signals up to 16 mA only are permitted if the equipment is subjected to special installation and performance restrictions.	No TNV.	N/A
Annex NAD	Equipment connected to a telecommunication and cable distribution networks and supplied with an earphone intended to be held against, or in the ear comply with special acoustic pressure requirements.	No TNV.	N/A

IEC60950_1C - ATTACHMENT			
Clause	Requirement + Test	Result - Remark	Verdict

ATTACHMENT TO TEST REPORT IEC 60950-1 FINLAND NATIONAL DIFFERENCES Information technology equipment – Safety – Part 1: General requirements			
Differences according to.....: EN 60950-1:2006/A11:2009/A1:2010			
Attachment Form No.: FL_ND_IEC60950_1C			
Attachment Originator: SGS Fimko Ltd			
Master Attachment: Date (2010-04)			
Copyright © 2010 IEC System for Conformity Testing and Certification of Electrical Equipment (IECEE), Geneva, Switzerland. All rights reserved.			

	National Differences		
General	See also Group Differences (EN 60950-1:2006/A11/A1)		
1.5.7.1	In Finland resistors bridging BASIC INSULATION in CLASS I PLUGGABLE EQUIPMENT TYPE A must comply with the requirements in 1.5.7.1. In addition when a single resistor is used, the resistor must withstand the resistor test in 1.5.7.2.		N/A
1.5.9.4	In Finland , the third dashed sentence is applicable only to equipment as defined in 6.1.2.2 of this annex.	No such construction.	N/A
1.7.2.1	In Finland , CLASS I PLUGGABLE EQUIPMENT TYPE A intended for connection to other equipment or a network shall, if safety relies on connection to protective earth or if surge suppressors are connected between the network terminals and accessible parts, have a marking stating that the equipment must be connected to an earthed mains socket-outlet. The marking text in in Finland shall be as follows: "Laite on liitettävä suojakoskettimilla varustettuun pistorasiaan"		N/A
2.3.2	In Finland , there are additional requirements for the insulation. See 6.1.2.1 and 6.1.2.2 of this annex.	No TNV.	N/A
2.10.5.13	In Finland , there are additional requirements for the insulation, see 6.1.2.1 and 6.1.2.2 of this annex.	No TNV.	N/A

IEC60950_1C - ATTACHMENT			
Clause	Requirement + Test	Result - Remark	Verdict
5.1.7.1	<p>In Finland, TOUCH CURRENT measurement results exceeding 3,5 mA r.m.s. are permitted only for the following equipment:</p> <ul style="list-style-type: none"> • STATIONARY PLUGGABLE EQUIPMENT TYPE A that <ul style="list-style-type: none"> - is intended to be used in a RESTRICTED ACCESS LOCATION where equipotential bonding has been applied, for example, in a telecommunication centre; and - has provision for a permanently connected PROTECTIVE EARTHING CONDUCTOR; and - is provided with instructions for the installation of that conductor by a SERVICE PERSON; • STATIONARY PLUGGABLE EQUIPMENT TYPE B; • STATIONARY PERMANENTLY CONNECTED EQUIPMENT. 	Not exceed 3.5mA.	N/A
6.1.2.1 (A1:2010)	<p>In Finland, add the following text between the first and second paragraph of the compliance clause:</p> <p>If this insulation is solid, including insulation forming part of a component, it shall at least consist of either</p> <ul style="list-style-type: none"> - two layers of thin sheet material, each of which shall pass the electric strength test below, or - one layer having a distance through insulation of at least 0,4 mm, which shall pass the electric strength test below. <p>Alternatively for components, there is no distance through insulation requirement for the insulation consisting of an insulating compound completely filling the casing, so that CLEARANCES and CREEPAGE DISTANCES do not exist, if the component passes the electric strength test in accordance with the compliance clause below and in addition</p> <ul style="list-style-type: none"> - passes the tests and inspection criteria of 2.10.11 with an electric strength test of 1,5 kV multiplied by 1,6 (the electric strength test of 2.10.10 shall be performed using 1,5 kV), and - is subject to ROUTINE TESTING for electric strength during manufacturing, using a test voltage of 1,5 kV. 	No TNV.	N/A

IEC60950_1C - ATTACHMENT			
Clause	Requirement + Test	Result - Remark	Verdict
	<p>It is permitted to bridge this insulation with an optocoupler complying with 2.10.5.4 b).</p> <p>It is permitted to bridge this insulation with a capacitor complying with EN 60384-14:2005, subclass Y2.</p> <p>A capacitor classified Y3 according to EN 60384-14:2005, may bridge this insulation under the following conditions:</p> <ul style="list-style-type: none"> - the insulation requirements are satisfied by having a capacitor classified Y3 as defined by EN 60384-14:2005 which in addition to the Y3 testing, is tested with an impulse test of 2,5 kV defined in EN 60950-1:2006, 6.2.2.1; - the additional testing shall be performed on all the test specimens as described in EN 60384-14:2005; - the impulse test of 2,5 kV is to be performed before the endurance test in EN 60384-14:2005, in the sequence of tests as described in EN 60384-14:2005. 		
6.1.2.2	<p>In Finland, the exclusions are applicable for PERMANENTLY CONNECTED EQUIPMENT, PLUGGABLE EQUIPMENT TYPE B and equipment intended to be used in a RESTRICTED ACCESS LOCATION where equipotential bonding has been applied, e.g. in a telecommunication centre, and which has provision for a permanently connected PROTECTIVE EARTHING CONDUCTOR and is provided with instructions for the installation of that conductor by a SERVICE PERSON.</p>	No TNV.	N/A
7.2	<p>In Finland, for requirements see 6.1.2.1 and 6.1.2.2 of this annex.</p> <p>The term TELECOMMUNICATION NETWORK in 6.1.2 being replaced by the term CABLE DISTRIBUTION SYSTEM.</p>	Not connected to cable distribution system.	N/A

IEC60950_1C - ATTACHMENT			
Clause	Requirement + Test	Result - Remark	Verdict

**ATTACHMENT TO TEST REPORT IEC 60950-1
GERMANY NATIONAL DIFFERENCES**

Information technology equipment – Safety –

Part 1: General requirements

Differences according to.....: VDE 0805-1:2011-01

Annex ZC, 1.7.2.1	According to GPSG, section 2, clause 4: If certain rules on the use, supplementation or maintenance of an item of technical work equipment or ready-to-use commodity must be observed in order to guarantee safety and health, instructions for use in German must be supplied when it is brought into circulation.		N/A
----------------------	--	--	------------

IEC60950_1C - ATTACHMENT			
Clause	Requirement + Test	Result - Remark	Verdict

**ATTACHMENT TO TEST REPORT IEC 60950-1
ISRAEL NATIONAL DIFFERENCES**

Information technology equipment – Safety –

Part 1: General requirements

Differences according to.....: SI 60950 Part 1

1.1.1	Replace the the text of Note 3 as follows: The requirements of Israel Standard SI 60065 may also be used to meet safety requirements for multimedia equipment. See IEC Guide 112, Guide on the safety of multimedia equipment.	Replaced.	P
1.6	The clause is applicable with the following addition:		N/A
1.6.1	Add following note: In Israel, this clause is applicable subject to the Electricity Law, 1954, its regulations and revisions.	Added	N/A
1.7	The clause is applicable with the following additions: Subclause 1.7.201 shall be added at the beginning of the clause as follows:	Added	N/A
1.7.201	Marking in the Hebrew language The marking in the Hebrew language shall be in accordance with the Consumer Protection Order (Marking of goods), 1983. In addition to the marking required by clause 1.7.1, the following details shall be marked in the Hebrew language. The details shall be marked on the apparatus or on its package, or on a label properly attached to the apparatus or on the package, by bonding or sewing, in a manner that the label cannot be easily removed. 1. Name of the apparatus and its commercial designation; 2. Manufacturer's name and address. If the apparatus is imported, the importer's name and address; 3. Manufacturer's registered trademark, if any; 4. Name of the model and serial number, if any; 5. Country of manufacture.		N/A
1.7.2.1	The following shall be added to the clause: All the instructions and warnings related to safety shall also be written in the Hebrew language.	Added	N/A
2	The clause is applicable with the following additions:		P

IEC60950_1C - ATTACHMENT			
Clause	Requirement + Test	Result - Remark	Verdict
2.9.4	<p>The following shall be added at the beginning of the clause:</p> <p>In Israel, according to the Electricity Law, 1954, and the Electricity Regulations (Earthing and means of protection against electricity of voltages up to 1,000V) 1991, seven means of protection against electrocution are permitted, as follows:</p> <ol style="list-style-type: none"> 1) TN-S - Network system earthing; TN-C-S - Network system earthing; 2) TT - Network system earthing; 3) IT - Network Insulation Terre; 4) Isolated transformer; 5) Safety extra low voltage (SELV or ELV); 6) Residual current circuit breaker (30 mA = I_{Δ}); 7) Reinforced insulation; Double insulation (class II) 	Added.	P
2.201	<p>Prevention of electromagnetic interference</p> <p>- Prior to carrying out the tests in accordance with the clauses of this Standard, the compliance of the apparatus with the relevant requirements specified in the appropriate part of the Standard series, SI 961, shall be checked.</p> <p><u>The apparatus shall meet the requirements in the appropriate part of the Standard series, SI 961.</u></p> <p>- If there are components in the apparatus for the prevention of electromagnetic interference, these components shall not reduce the safety level of the apparatus as required by this Standard.</p>		N/A
3	The clause is applicable with the following additions:		
3.2.1.1	<p>Connection to an a.c. mains supply</p> <p>After the note, the following note shall be added:</p> <p>Note:</p> <p>In Israel, the feed plug shall comply with the requirements of Israel Standard SI 32 Part 1.1.</p>	No feed plug provided.	N/A
3.2.1.2	<p>Connection to a d.c. mains supply</p> <p>At the end of the first paragraph, the following note shall be added:</p> <p>Note:</p> <p>At the time of issue of this Standard, there is no Israel Standard for connection accessories to d.c.</p>	No connected to d.c. mains supply	N/A
Annex P	<p>Normative references</p> <p>(List of relevant Israel Standards that have been inserted in place of some of the International Standards)</p>	Inserted	P

IEC60950_1C - ATTACHMENT			
Clause	Requirement + Test	Result - Remark	Verdict

**ATTACHMENT TO TEST REPORT IEC 60950-1
KOREA NATIONAL DIFFERENCES**

Information technology equipment – Safety –

Part 1: General requirements

Differences according to.....: K 60950-1

1.5.101	Plugs for the connection of the apparatus to the supply mains shall comply with the Korean requirement (KSC 8305)	No power supply cord provided.	N/A
8	EMC The apparatus shall comply with the relevant CISPR standards.		N/A

IEC60950_1C - ATTACHMENT			
Clause	Requirement + Test	Result - Remark	Verdict

**ATTACHMENT TO TEST REPORT IEC 60950-1
U.S.A. NATIONAL DIFFERENCES**

Information technology equipment – Safety –

Part 1: General requirements

Differences according to.....: UL 60950-1-07

Attachment Form No.....: US_ND_IEC60950_1C

Attachment Originator.....: TÜV SÜD Product Service GmbH

Master Attachment.....: Date (2012-08)

Copyright © 2012 IEC System for Conformity Testing and Certification of Electrical Equipment (IECEE), Geneva, Switzerland. All rights reserved.

	Special national conditions		
1.1.1	All equipment is to be designed to allow installation in accordance with the National Electrical Code (NEC), ANSI/NFPA 70, the Canadian Electrical Code (CEC), Part I, CAN/CSA C22.1, and when applicable, the National Electrical Safety Code, IEEE C2.	In accordance with the National Electrical Code (NEC), ANSI/NFPA 70, and unless marked or otherwise identified, the Standard for Electronic Computer/Data-Processing Equipment, ANSI/NFPA 75.	P
	Also, unless marked or otherwise identified, installation is allowed per the Standard for the Protection of Electronic Computer/Data-Processing Equipment, ANSI/NFPA 75.		P
1.4.14	For Pluggable Equipment Type A, the protection in the installation is assumed to be 20A.	Considered.	P
1.5.5	For lengths exceeding 3.05 m, external interconnecting flexible cord and cable assemblies are required to be a suitable cable type (e.g., DP, CL2) specified in the CEC/NEC.	No external cable provided.	N/A
	For lengths 3.05 m or less, external interconnecting flexible cord and cable assemblies that are not types specified in the CEC are required to have special construction features and identification markings.		N/A
1.7.1	Equipment for use on a.c. mains supply systems with a neutral and more than one phase conductor (e.g. 120/240 V, 3-wire) require a special marking format for electrical ratings.	Single-phase equipment.	N/A
	A voltage rating that exceeds an attachment plug cap rating is only permitted if it does not exceed the extreme operating conditions in Table 2 of CAN/CSA C22.2 No. 235, and		N/A

IEC60950_1C - ATTACHMENT			
Clause	Requirement + Test	Result - Remark	Verdict
	- if it is part of a range that extends into the Table 2 "Normal Operating Conditions."		N/A
	A voltage rating is not to be lower than the specified "Normal Operating Conditions," unless it is part of a range that extends into the "Normal Operating Conditions."		N/A
1.7.7	Wiring terminals intended to supply Class 2 outputs in accordance with CEC Part 1 or NEC are marked with the voltage rating and "Class 2" or equivalent.	No wiring terminals.	N/A
	- Marking is located adjacent to the terminals		N/A
	- Marking is visible during wiring		N/A
2.5	Fuse providing Class 2, Limited Power Source, or TNV current limiting is not operator-accessible unless it is not interchangeable.	Not operator-accessible.	P
2.6.3.3	Modify first column on Table 2D to "Smaller of the RATED CURRENT of the equipment or the PROTECTIVE CURRENT RATING of the circuit under consideration."	Considered.	P
2.7.1	Suitable NEC/CEC branch circuit protection rated at the maximum circuit rating is provided for all standard supply outlets and receptacles (such as supplied in power distribution units) if the supply branch circuit protection is not suitable.	No such components provided.	N/A
	Power distribution transformers distributing power at 100 volts or more, and rated 10 kVA or more, provided with special transformer overcurrent protection.		N/A
3.2	Wiring methods (terminals, leads, etc.) used for the connection of the equipment to the mains is in accordance with the NEC/CEC.		N/A
3.2.1	Attachment plugs of power supply cords are rated not less than 125 per cent of the rated current of the equipment.		N/A
3.2.1.2	Equipment connected to a centralized d.c. power system, and having one pole of the DC mains input terminal connected to the main protective earthing terminal in the equipment comply with special earthing, wiring, marking and installation instruction requirements.	No power supply cord provided.	N/A
3.2.3	Permanent connection of equipment to the mains supply by a power supply cord is not permitted, except for certain equipment, such as ATMs.	No connection to a centralized d.c. power system.	N/A
3.2.5	Power supply cords are no longer than 4.5 m in length.	Pluggable equipment type A.	N/A

IEC60950_1C - ATTACHMENT			
Clause	Requirement + Test	Result - Remark	Verdict
	Minimum cord length is 1.5 m, with certain constructions such as external power supplies allowed to consider both input and output cord lengths into the requirement.		N/A
	Flexible power supply cords are compatible with Article 400 of the NEC, and Tables 11 and 12 of the CEC.		N/A
3.2.9	Permanently connected equipment have a suitable wiring compartment and wire bending space.	Pluggable equipment type A.	N/A
3.3	Wiring terminals and associated spacings for field wiring connections comply with CSA C22.2 No. 0.	No wiring terminals.	N/A
3.3.3	Wire binding screws are not permitted to attach conductors larger than 10 AWG (5.3 mm ²).	No wire binding screws.	N/A
3.3.4	Terminals for permanent wiring, including protective earthing terminals, are suitable for Canadian/US wire gauge sizes, are	Pluggable equipment type A.	N/A
	- rated 125 per cent of the equipment rating, and		N/A
	- are specially marked when specified (1.7.7).		N/A
3.3.5	Revise first column of Table 3E to "Smaller of the RATED CURRENT of the equipment or the PROTECTIVE CURRENT RATING of the circuit under consideration."	Considered.	P
3.4.2	Motor control devices are provided for cord-connected equipment with a motor if the equipment is rated more than 12 A,	Equipment is not such a device.	N/A
	- or if the motor has a nominal voltage rating greater than 120 V		N/A
	- or is rated more than 1/3 hp (locked rotor current over 43 A)		N/A
3.4.8	Vertically-mounted disconnect switches and circuit breakers have the "on" position indicated by the handle in the up position.	No such devices incorporated.	N/A
3.4.11	For computer room applications, equipment with battery systems capable of supplying 750 VA for five minutes have a battery disconnect means that may be connected to the computer room remote power-off circuit.	Not such an application.	N/A
4.3.12	The maximum quantity of flammable liquid stored in equipment complies with NFPA 30.	No liquids.	N/A
4.3.13.5	Equipment with lasers meet the Canadian Radiation Emitting Devices Act, REDR C1370 and/or Code of Federal Regulations 21 CFR 1040, as applicable.	No lasers.	N/A

IEC60950_1C - ATTACHMENT			
Clause	Requirement + Test	Result - Remark	Verdict
4.7	For computer room applications, automated information storage systems with combustible media greater than 0.76 m ³ (27 cu ft) have a provision for connection of either automatic sprinklers or a gaseous agent extinguishing system with an extended discharge.	Not such an application.	N/A
4.7.3.1	For computer room applications, enclosures with combustible material measuring greater than 0.9 m ² (10 sq ft) or a single dimension greater than 1.8 m (6 ft) have a flame spread rating of 50 or less.	Not such an application.	N/A
	For other applications, enclosures with the same dimensions require a flame spread rating of 200 or less.		N/A
Annex H	Equipment that produces ionizing radiation complies with U.S. Code of Federal Regulations, 21 CFR 1020 (and the Canadian Radiation Emitting Devices Act, REDR C1370).	Equipment is not such a device.	N/A
	Other National Differences		
1.5.1	Some components and materials associated with the risk of fire, electric shock, or personal injury have component or material ratings in accordance with the applicable national (Canadian and/or U.S.) component or material standard requirements.	Complied. See table 1.5.1	P
1.6.1.2	A circuit for connection to the DC Mains Supply is classified as either a SELV Circuit, TNV-2 Circuit or Hazardous Voltage Circuit depending on the maximum operating voltage of the supply.	No connection to the DC Mains Supply.	N/A
	This maximum operating voltage includes consideration of the battery charging "float voltage" associated with the intended supply system, regardless of the marked power rating of the equipment.		N/A
2.3.1	For TNV-2 and TNV-3 circuits with other than ringing signals and with voltages exceeding 42.4 V _{peak} or 60 V _{d.c.} , the maximum acceptable current through a 2000 ohm resistor (or greater) connected across the voltage source with other loads disconnected is 7.1 mA peak or 30 mA d.c. under normal operating conditions.	No TNV circuits.	N/A
2.3.2.1	In the event of a single fault between TNV and SELV circuits, the limits of 2.2.3 apply to SELV Circuits and accessible conductive parts.	No TNV circuits.	N/A
2.6.3.4	Protective bonding conductors of non-standard protective bonding constructions (e.g., printed circuit traces) may be subjected to the additional limited short circuit test conditions specified.		P

IEC60950_1C - ATTACHMENT			
Clause	Requirement + Test	Result - Remark	Verdict
4.2.8.1	Enclosures around CRTs with a face diameter of 160 mm or more reduce the risk of injury due to the implosion of the CRT.	No CRTs.	N/A
4.3.2	Equipment with handles complies with special loading tests.	No handles.	N/A
5.1.8.3	Equipment intended to receive telecommunication ringing signals comply with a special touch current measurement tests.	No TNV.	N/A
5.3.7	Internal (e.g., card cage) SELV circuit connectors and printed wiring board connectors that are accessible to the operator and that deliver power are overloaded.		N/A
	During abnormal operating testing, if a circuit is interrupted by the opening of a component, the test shall be repeated twice (three tests total) using new components as necessary		N/A
6.4	Equipment intended for connection to telecommunication network outside plant cable is protected against overvoltage from power line crosses in accordance with 6.4 and Annex NAC.	No TNV.	N/A
Annex EE	Articulated accessibility probe (Fig EE.3) is used for assessing accessibility to document/media shredders instead of the Figure 2A test finger.	No document (paper) shredder.	N/A
Annex M.2	Continuous ringing signals up to 16 mA only are permitted if the equipment is subjected to special installation and performance restrictions.	No TNV.	N/A
Annex NAD	Equipment connected to a telecommunication and cable distribution networks and supplied with an earphone intended to be held against, or in the ear comply with special acoustic pressure requirements.	No TNV.	N/A

IEC60950_1C - ATTACHMENT			
Clause	Requirement + Test	Result - Remark	Verdict

ATTACHMENT TO TEST REPORT IEC 60950-1
AUSTRALIA and NEW ZEALAND NATIONAL DIFFERENCES
Information technology equipment – Safety –
Part 1: General requirements

Differences according to.....: AS/NZS 60950.1:2011

1.2	Insert the following between 'person, service' and 'range, rated frequency': POTENTIAL IGNITION SOURCE 1.2.12		N/A
1.2.12.201	Insert a new Clause 1.2.12.201 after Clause 1.2.12.15 as follows: 1.2.12.201 POTENTIAL IGNITION SOURCE Possible fault which can start a fire if the open-circuit voltage measured across an interruption or faulty contact exceeds a value of 50 V (peak) a.c. or d.c. and the product of the peak value of this voltage and the measured r.m.s. current under normal operating conditions exceeds 15 VA. Such a faulty contact or interruption in an electrical connection includes those which may occur in CONDUCTIVE PATTERNS on PRINTED BOARDS. NOTE 201 An electronic protection circuit may be used to prevent such a fault from becoming a POTENTIAL IGNITION SOURCE. NOTE 202 This definition is from AS/NZS 60065:2003.		N/A
1.5.1	1. Add the following to the end of the first paragraph: 'or the relevant Australian/New Zealand Standard.' 2. In NOTE 1, add the following after the word 'standard': 'or an Australian/New Zealand Standard'	Added.	P
1.5.2	Add the following to the end of the first and third dash items: 'or the relevant Australian/New Zealand Standard'	Added.	P

IEC60950_1C - ATTACHMENT																				
Clause	Requirement + Test	Result - Remark	Verdict																	
3.2.5.1	<p>Modify Table 3B as follows:</p> <p>1. Delete the first four rows and replace with the following:</p> <table border="1"> <thead> <tr> <th rowspan="2">RATED CURRENT of equipment A</th> <th colspan="2">Minimum conductor sizes</th> </tr> <tr> <th>Nominal cross-sectional area mm²</th> <th>AWG or kcmil [cross-sectional area in mm²] see Note 2</th> </tr> </thead> <tbody> <tr> <td>Over 0.2 up to and including 3</td> <td>0,5 ^a</td> <td>18 [0,8]</td> </tr> <tr> <td>Over 3 up to and including 7.5</td> <td>0,75</td> <td>16 [1,3]</td> </tr> <tr> <td>Over 7.5 up to and including 10</td> <td>(0,75) ^b 1,00</td> <td>16 [1,3]</td> </tr> <tr> <td>Over 10 up to and including 16</td> <td>(1,0) ^c 1,5</td> <td>14 [2]</td> </tr> </tbody> </table> <p>2. Delete NOTE 1.</p> <p>3. Delete Footnote ^a and replace with the following: ^a This nominal cross-sectional area is only allowed for Class II appliances if the length of the power supply cord, measured between the point where the cord, or cord guard, enters the appliance, and the entry to the plug does not exceed 2 m (0,5 mm² three-core supply flexible cords are not permitted; see AS/NZS 3191).</p>	RATED CURRENT of equipment A	Minimum conductor sizes		Nominal cross-sectional area mm ²	AWG or kcmil [cross-sectional area in mm ²] see Note 2	Over 0.2 up to and including 3	0,5 ^a	18 [0,8]	Over 3 up to and including 7.5	0,75	16 [1,3]	Over 7.5 up to and including 10	(0,75) ^b 1,00	16 [1,3]	Over 10 up to and including 16	(1,0) ^c 1,5	14 [2]	Replaced.	N/A
RATED CURRENT of equipment A	Minimum conductor sizes																			
	Nominal cross-sectional area mm ²	AWG or kcmil [cross-sectional area in mm ²] see Note 2																		
Over 0.2 up to and including 3	0,5 ^a	18 [0,8]																		
Over 3 up to and including 7.5	0,75	16 [1,3]																		
Over 7.5 up to and including 10	(0,75) ^b 1,00	16 [1,3]																		
Over 10 up to and including 16	(1,0) ^c 1,5	14 [2]																		
4.1.201	<p>Insert a new Clause 4.1.201 after Clause 4.1 as follows:</p> <p>4.1.201 Display devices used for television purposes</p> <p>Display devices which may be used for television purposes, with a mass of 7 kg or more, shall comply with the requirements for stability and mechanical hazards, including the additional stability requirements for television receivers, specified in AS/NZS 60065.</p>	No such device.	N/A																	
4.3.6	<p>Delete the third paragraph and replace with the following:</p> <p><i>Equipment with a plug portion, suitable for insertion into a 10 A 3-pin flatpin socket-outlet complying with AS/NZS 3112 shall comply with the requirements in AS/NZS 3112 for equipment with integral pins for insertion into socket-outlets.</i></p>		N/A																	
4.3.16.5	<p>Add the following to the end of the first paragraph: 'or AS/NZS 2211.1'</p>	Added.	N/A																	

IEC60950_1C - ATTACHMENT			
Clause	Requirement + Test	Result - Remark	Verdict
4.7	Add the following new paragraph to the end of the clause: 'For alternate tests refer to Clause 4.7.201.'	Added.	P
4.7.201	Insert a new Clause 4.7.201 after Clause 4.7.3.6 as follows: 4.7.201 Resistance to fire – Alternative tests	Added. Alternative tests not applied for	N/A
4.7.201.1	<p>4.7.201.1 General</p> <p>Parts of non-metallic material shall be resistant to ignition and spread of fire.</p> <p>This requirement does not apply to decorative trims, knobs and other parts unlikely to be ignited or to propagate flames from inside the apparatus, or the following:</p> <p>(a) Components that are contained in an enclosure having a flammability category of V-0 according to AS/NZS 60695.11.10 and having openings only for the connecting wires filling the openings completely, and for ventilation not exceeding 1mm in width regardless of length.</p> <p>(b) The following parts which would contribute negligible fuel to a fire:</p> <ul style="list-style-type: none"> - small mechanical parts, the mass of which does not exceed 4g, such as mounting parts, gears, cams, belts and bearings; - small electrical components, such as capacitors with a volume not exceeding 1,750 mm³, integrated circuits, transistors and optocoupler packages, if these components are mounted on material of flammability category V-1, or better, according to AS/NZS 60695.11.10. <p>NOTE In considering how to minimize propagation of fire and what 'small parts' are, account should be taken of the cumulative effect of small parts adjacent to each other for the possible effect of propagating the fire from one part to another.</p> <p>Compliance shall be checked by the tests of 4.7.201.2, 4.7.201.3, 4.7.201.4 and 4.7.201.5.</p> <p>For the base material of printed boards, compliance shall be checked by the test of 4.7.201.5.</p> <p>The tests shall be carried out on parts of non-metallic material which have been removed from the apparatus. When the glow-wire test is carried out, the parts shall be placed in the same orientation as they would be in normal use.</p> <p>These tests are not carried out on internal wiring.</p>		N/A

IEC60950_1C - ATTACHMENT									
Clause	Requirement + Test	Result - Remark	Verdict						
4.7.201.2	<p>4.7.201.2 Testing of non-metallic materials</p> <p>Parts of non-metallic material shall be subject to the glow-wire test of AS/NZS 60695.2.11 which shall be carried out at 550 °C.</p> <p>Parts for which the glow-wire test cannot be carried out, such as those made of soft or foamy material, shall meet the requirements specified in ISO 9772 for category FH-3 material. The glow-wire test shall be not carried out on parts of material classified at least FH-3 according to ISO 9772 provided that the sample tested was not thicker than the relevant part.</p>		N/A						
4.7.201.3	<p>4.7.201.3 Testing of insulating materials</p> <p>Parts of insulating material supporting POTENTIAL IGNITION SOURCES shall be subject to the glow-wire test of AS/NZS 60695.2.11 which shall be carried out at 750 °C.</p> <p>The test shall be also carried out on other parts of insulating material which are within a distance of 3 mm of the connection.</p> <p>NOTE Contacts in components such as switch contacts are considered to be connections.</p> <p>For parts which withstand the glow-wire test but produce a flame, other parts above the connection within the envelope of a vertical cylinder having a diameter of 20 mm and a height of 50 mm shall be subjected to the needle-flame test. However, parts shielded by a barrier which meets the needle-flame test shall not be tested.</p> <p>The needle-flame test shall be made in accordance with AS/NZS 60695.11.5 with the following modifications:</p> <table border="1" data-bbox="422 1406 1008 2056"> <tr> <td>Clause of AS/NZS 60695.11.5</td> <td>Change</td> </tr> <tr> <td colspan="2">9 Test procedure</td> </tr> <tr> <td>9.2 Application of needleflame</td> <td> Replace the first paragraph with: The specimen shall be arranged so that the flame can be applied to a vertical or horizontal edge as shown in the examples of figure 1. If possible the flame shall be applied at least 10 mm from a corner Replace the second paragraph with: The duration of application of the test flame shall be 30 s </td> </tr> </table>	Clause of AS/NZS 60695.11.5	Change	9 Test procedure		9.2 Application of needleflame	Replace the first paragraph with: The specimen shall be arranged so that the flame can be applied to a vertical or horizontal edge as shown in the examples of figure 1. If possible the flame shall be applied at least 10 mm from a corner Replace the second paragraph with: The duration of application of the test flame shall be 30 s		N/A
Clause of AS/NZS 60695.11.5	Change								
9 Test procedure									
9.2 Application of needleflame	Replace the first paragraph with: The specimen shall be arranged so that the flame can be applied to a vertical or horizontal edge as shown in the examples of figure 1. If possible the flame shall be applied at least 10 mm from a corner Replace the second paragraph with: The duration of application of the test flame shall be 30 s								

IEC60950_1C - ATTACHMENT									
Clause	Requirement + Test	Result - Remark	Verdict						
	<table border="1"> <tr> <td></td> <td>±1 s.</td> </tr> <tr> <td>9.3 Number of test specimens</td> <td>Replace with: The test shall be made on one specimen. If the specimen does not withstand the test, the test may be repeated on two further specimens, both of which shall withstand the test.</td> </tr> <tr> <td>11 Evaluation of test results</td> <td>Replace with: The duration of burning (t_b) shall not exceed 30 s. However, for printed circuit boards, it shall not exceed 15 s.</td> </tr> </table> <p>The needle-flame test shall not be carried out on parts of material classified as V-0 or V-1 according to AS/NZS 60695.11.10, provided that the sample tested was not thicker than the relevant part.</p>		±1 s.	9.3 Number of test specimens	Replace with: The test shall be made on one specimen. If the specimen does not withstand the test, the test may be repeated on two further specimens, both of which shall withstand the test.	11 Evaluation of test results	Replace with: The duration of burning (t _b) shall not exceed 30 s. However, for printed circuit boards, it shall not exceed 15 s.		
	±1 s.								
9.3 Number of test specimens	Replace with: The test shall be made on one specimen. If the specimen does not withstand the test, the test may be repeated on two further specimens, both of which shall withstand the test.								
11 Evaluation of test results	Replace with: The duration of burning (t _b) shall not exceed 30 s. However, for printed circuit boards, it shall not exceed 15 s.								
4.7.201.4	<p>4.7.201.4 Testing in the event of non-extinguishing material</p> <p>If parts, other than enclosures, do not withstand the glow wire tests of 4.7.201.3, by failure to extinguish within 30 s after the removal of the glowwire tip, the needle-flame test detailed in 4.7.201.3 shall be made on all parts of non-metallic material which are within a distance of 50 mm or which are likely to be impinged upon by flame during the tests of 4.7.201.3. Parts shielded by a separate barrier which meets the needle-flame test need not be tested.</p> <p>NOTE 1 If the enclosure does not withstand the glow -wire test the equipment is considered to have failed to meet the requirements of Clause 4.7.201 without the need for consequential testing.</p> <p>NOTE 2 If other parts do not withstand the glow -wire test due to ignition of the tissue paper and if this indicates that burning or glowing particles can fall onto an external surface underneath the equipment, the equipment is considered to have failed to meet the requirements of Clause 4.7.201 without the need for consequential testing.</p> <p>NOTE 3 Parts likely to be impinged upon by the flame are considered to be those within the envelope of a vertical cylinder having a radius of 10 mm and a height equal to the height of the flame, positioned above the point of the material supporting, in contact with, or in close proximity to, connections.</p>		N/A						
4.7.201.5	<p>4.7.201.5 Testing of printed boards</p> <p>The base material of printed boards shall be subjected to the needle-flame test of Clause 4.7.201.3. The flame shall be applied to the edge</p>		N/A						

IEC60950_1C - ATTACHMENT			
Clause	Requirement + Test	Result - Remark	Verdict
	<p>of the board where the heat sink effect is lowest when the board is positioned as in normal use. The flame shall not be applied to an edge, consisting of broken perforations, unless the edge is less than 3 mm from a POTENTIAL IGNITION SOURCE.</p> <p>The test is not carried out if the —</p> <ul style="list-style-type: none"> - Printed board does not carry any POTENTIAL IGNITION SOURCE; - Base material of printed boards, on which the available apparent power at a connection exceeds 15 VA operating at a voltage exceeding 50 V and equal or less than 400 V (peak) a.c. or d.c. under normal operating conditions, is of flammability category V-1 or better according to AS/NZS 60695.11.10, or the printed boards are protected by an enclosure meeting the flammability category V-0 according to AS/NZS 60695.11.10, or made of metal, having openings only for connecting wires which fill the openings completely; or - Base material of printed boards, on which the available apparatus power at a connection exceeds 15 VA operating at a voltage exceeding 400 V (peak) a.c. or d.c. under normal operating conditions, and base material of printed boards supporting spark gaps which provides protection against overvoltages, is of flammability category V-0 according to AS/NZS 60695.11.10 or the printed boards are contained in a metal enclosure, having openings only for connecting wires which fill the openings completely. <p>Compliance shall be determined using the smallest thickness of the material.</p> <p>NOTE Available apparent power is the maximum apparent power which can be drawn from the supplying circuit through a resistive load whose value is chosen to maximise the apparent power for more than 2 min when the circuit supplied is disconnected.</p>		
6.2.2	<p>For Australia only, delete the first paragraph and Note, and replace with the following:</p> <p>In Australia only, compliance with 6.2.2 shall be checked by the tests of both 6.2.2.1 and 6.2.2.2.</p>	No TNV.	N/A

IEC60950_1C - ATTACHMENT			
Clause	Requirement + Test	Result - Remark	Verdict
6.2.2.1	<p>For Australia only, delete the first paragraph including the Notes, and replace with the following:</p> <p><i>In Australia only, the electrical separation is subjected to 10 impulses of alternating polarity, using the impulse test generator reference 1 of Table N.1. The interval between successive impulses is 60 s and the initial voltage, U_c, is:</i></p> <p><i>(i) for 6.2.1 a): 7.0 kV for hand-held telephones and for headsets and 2.5 kV for other equipment; and</i></p> <p><i>(ii) for 6.2.1 b) and 6.2.1 c): 1.5 kV.</i></p> <p>NOTE 201 The 7 kV impulse simulates lightning surges on typical rural and semi-rural network lines.</p> <p>NOTE 202 The value of 2.5 kV for 6.2.1 a) was chosen to ensure the adequacy of the insulation concerned and does not necessarily simulate likely overvoltages.</p>	No TNV.	N/A
6.2.2.2	<p>For Australia only, delete the second paragraph including the Note, and replace with the following:</p> <p><i>In Australia only, the a.c. test voltage is:</i></p> <p><i>(i) for 6.2.1 a): 3 kV; and</i></p> <p><i>(ii) for 6.2.1 b) and 6.2.1 c): 1.5 kV.</i></p> <p>NOTE 201 Where there are capacitors across the insulation under test, it is recommended that d.c. test voltages are used.</p> <p>NOTE 202 The 3 kV and 1.5 kV values have been determined considering the low frequency induced voltages from the power supply distribution system.</p>	No TNV.	N/A
7.3	<p>Add the following before the first paragraph:</p> <p>Equipment providing functions that fall only within the scope of AS/NZS 60065 and that incorporate a PSTN interface, are not required to comply with this Clause where the only ports provided on the equipment, in addition to a coaxial cable connection and a PSTN interface, are audio or video ports and analogue or data ports not intended to be used for telecommunications purposes.</p>	Not connected to cable distribution system.	N/A
Annex P	<p>Normative references</p> <p>(List of relevant Australia/New Zealand Standards that have been inserted in place of some of the International Standards)</p>	Added.	P

IEC60950_1C - ATTACHMENT			
Clause	Requirement + Test	Result - Remark	Verdict

J 60950-1 (H22) : 2009 TEST REPORT

(Deviations from IEC 60950-1:2001, first edition)

Special National conditions, National deviation and other information according to MITI Ordinance No. 85.
Japanese unique deviations in J60950-1(H22):2009(=JIS C 6950-1:2009)

1.1.A	Add this sub-clause See Annex P for normative references	Added.	P
1.2	Add the following terms. Equipment, Class 0I 1.2.4.3A	Added.	P
1.2.4.1	Add the following NOTE 2: NOTE 2 – Even in the case of CLASS 0I equipment, two-pins plug with a protective earthing lead wire (an adapter for converting a Class 0I equipment plug into a two-pin plug without earthing wire) and cord sets having a two-pin type plug with a lead wire for earthing are also regarded as Class 0I equipment if they are included in packaging as accessories or if users are recommended to use them.	Added.	P
1.2.4.3A	Add this sub-clause: CLASS 0I EQUIPMENT: Equipment where protection against electric shock is achieved by: using BASIC INSULATION, and providing a means of connecting to the protective earthing conductor in the building wiring those conductive parts that are otherwise capable of assuming HAZARDOUS VOLTAGES if the BASIC INSULATION fails, and using a supply cord without earthing conductor and a plug without earthing wire although the equipment has externally an earth terminal or a lead wire for earthing. Equipment provided with a cord set having a two-pin type plug with a lead wire for earthing is also regarded as Class 0I. NOTE – Class 0I equipment may have a part constructed with Double Insulation or Reinforced Insulation as well as an operating part as SELV circuit.	Added.	P

IEC60950_1C - ATTACHMENT			
Clause	Requirement + Test	Result - Remark	Verdict
1.3.2	<p>Add the following NOTE 1 and 2:</p> <p>Note1: transportable equipments or similar equipments that are frequently transported for use should not be considered Class I or Class 0I equipments. However, this shall not apply to equipments that are intended for installation by service personnel or installation personnel.</p> <p>Note 2: in consideration of the state of electrical power distribution in Japan, it is best to avoid the use of Class I or Class 0I devices if it is evident that it will be difficult to connect earthing during installation of the equipment. However, this shall not apply to devices that are intended for installation by service personnel or installation personnel.</p>	Added.	N/A
1.5.1	<p>When safety issues apply, in the absence of matters required by these specifications or JIS stipulated required matters concerning safety of related components, or in the absence of JIS concerning the component, the component must comply with one of the related IEC safety requirements. However, if a component compliant with ministerial ordinance (1962 Trade and Commerce Ministerial Ordinance No. 85) providing technical standards for electrical products is being used in accordance with the rating indicated for that component, apply articles 1.5.4, 2.8.7 and 3.2.5; electrical power cord sets that fit with inlets for equipments regulated by the IEC 60320-1 Standards Sheet must match the dimensions indicated on the applicable IEC 60320-1 Connector Standards Sheet.</p> <p>Note 1: regarding the JIS or IEC standards related to a component as related shall be limited to cases where the component in question is clearly within the scope of application of those standards.</p>		P

IEC60950_1C - ATTACHMENT			
Clause	Requirement + Test	Result - Remark	Verdict
1.5.2	<p>In the case of components that are certified as being in compliance with JIS harmonized with the related IEC, it must be confirmed that the component is being used correctly in accordance with the stipulated standards. In the absence of JIS harmonized with the related IEC,</p> <p>Note 1: When using an IEC 60320-1 C.14 device coupler with rated voltage less than 125 V and rated current in excess of 10A, refer to 1.7.5A.</p> <p>If JIS harmonized with the IEC related to the component does not exist concurrently with the IEC standards, or if the component is using circuitry that does not comply with its rating, the component must be tested in accordance with the conditions and within equipment. The number of samples required for testing shall normally be the same as the number required under similar standards.</p>		P
1.5.6	Replace "IEC 60384-14:1993" to "JIS C 5101-14:1998 or IEC 60384-14:1993" of this Sub-Clause	Replaced.	P
1.5.7.2	Replace "IEC 60384-14:1993" to "JIS C 5101-14:1998 or IEC 60384-14:1993" of this Sub-Clause	Replaced.	P
1.5.8	Replace "IEC 60384-14:1993" to "JIS C 5101-14:1998 or IEC 60384-14:1993" of this Sub-Clause	Replaced.	N/A
1.7.1	Add local importer in this sub-clause manufacturer's name or local importer or trade-mark or identification mark;	Added.	N/A
1.7.5	Replace "IEC 60083" to "IEC/TR 60083:1997 or JIS C 8303:2007" of this Sub-Clause	Replaced.	N/A
1.7.5.A	<p>Add this sub-clause</p> <p>1.7.5A Device Coupler</p> <p>When using an IEC 60320-1 C.14 device coupler (rated current 10A) with rated voltage less than 125 V and rated current in excess of 10A, be sure to write "Only use power supply cord sets that are provided with this device" or a similar statement in the user's manual.</p>	Added.	N/A

IEC60950_1C - ATTACHMENT			
Clause	Requirement + Test	Result - Remark	Verdict
1.7.17A	<p>Add this sub-clause:</p> <p><i>Marking for CLASS 0I EQUIPMENT</i></p> <p>For CLASS 0I EQUIPMENT, the following instruction shall be indicated on the visible place of the mains plug or the main body: “Provide an earthing connection”</p> <p><i>Example in Japanese:</i> 必ず接地接続を行って下さい</p> <p>Moreover, for CLASS 0I EQUIPMENT, the following instruction shall be indicated on the visible place of the main body or written in the operating instructions: “Provide an earthing connection before the mains plug is connected to the mains. And, when disconnecting the earthing connection, be sure to disconnect after pulling out the mains plug from the mains.”</p> <p><i>Example in Japanese:</i> 接地接続は必ず、電源プラグを電源につなぐ前に行ってください。又、接地接続を外す場合は、必ず電源プラグを電源から切り離してから行って下さい。</p>	Added.	P
2.1.1.1	In the Item b) of this Sub-Clause, replace “IEC 60083” to “IEC 60083 or JIS C 8303:2007”.	Replaced.	N/A
2.6.3.2	<p>Add the following in front of 1st paragraph of this Sub-Clause.</p> <p>This also applies to the conductor of lead wire for protective earthing of CLASS 0I EQUIPMENT.</p>	Added.	P
2.6.3.4	<p>Add the following in this Sub-Clause.</p> <p>(See 2.6.3.3)</p>	Added.	P
2.6.4.2	<p>Add the following after 1st paragraph of this Sub-Clause.</p> <p>However, this shall not apply when the Class 0I equipment is equipped with a separate main protective earthing terminal.</p>	Added.	N/A
2.6.5.4	<p>Replace the first sentence of this Sub-Clause by:</p> <p>Protective earthing connections of CLASS I EQUIPMENT shall make earlier and break later than the supply connections in each of the following:</p>	Replaced.	N/A

IEC60950_1C - ATTACHMENT			
Clause	Requirement + Test	Result - Remark	Verdict
2.6.5.8A	<p>Add this sub-clause:</p> <p><i>Earthing of CLASS 0I EQUIPMENT</i></p> <p>Plugs with a lead wire for earthing shall not be used for equipment having a rated voltage exceeding 150V.</p> <p>For plugs with a lead wire for earthing, the lead wire shall not be earthed by a clip.</p> <p>CLASS 0I EQUIPMENT shall be provided with an earthing terminal or lead wire for earthing in the external where easily visible.</p>	Added.	P
2.10.1	Replace "IEC 60664-1" to "JIS C 0664:2003" in NOTE of this Sub-Clause	Replaced.	P
2.10.3.1	Replace "IEC 60664-1" to "JIS C 0664:2003" in NOTE 1 and NOTE 2	Replaced.	P
2.10.3.2	Replace "IEC 60664-1" to "JIS C 0664:2003" in the first sentence of this Sub-Clause	Replaced.	P
3.2.3	<p>Add the following after Table 3A of this Sub-Clause.</p> <p>Table 3A shall apply when a JIS C 3662 or JIS C 3663 compliant cable is used. Other cables that are used must be designed to allow suitable conduits to be run in,</p>	Added.	N/A
3.2.5.1	<p>Add the following of this Sub-Clause.</p> <p>Or must be sheathed in accordance with Section 1, Annex 1 of the ministerial ordinance (1962 Trade and Commerce Ministerial Ordinance No. 85) providing technical standards for electrical products.</p> <p>- Or must be sheathed in accordance with Section 1, Annex 1 of the ministerial ordinance (1962 Trade and Commerce Ministerial Ordinance No. 85) providing technical standards for electrical products.</p> <p>- Electric cables that comply with JIS C 3662 or JIS C 3663 have a conductor with a cross-sectional area value greater than the values provided for in Table 3B. Other electrical cables comply with relevant wiring regulations.</p> <p>Delete 1) in Table 3B.</p>	Deleted.	P
3.3.4	<p>Add the following in Table 3D</p> <p>Note: when using JIS C 3662 or JIS C 3663-compliant electrical wiring, the terminal must enable connection of electric wiring commensurate with the regulated sizes</p>	Added.	P

IEC60950_1C - ATTACHMENT			
Clause	Requirement + Test	Result - Remark	Verdict
3.3.7	Add the following after 1 st paragraph of this Sub-Clause. However, this shall not apply to the external grounding terminals of Class 0I equipment.	Added.	N/A
4.3.4	Add the following of this Sub-Clause. Class 0I equipment where the values for creepage distance and clearance distance of the basic insulation drop further to a level lower than that stipulated in 2.10 must be properly fixed to withstand the mechanical stress generated in the course of normal use.	Added.	N/A
4.3.5	Replace "IEC 60083" to "JIS C 8303:2007" in the first sentence of this Sub-Clause	Replaced.	N/A
4.3.13.3	Add the following in Table 4A Note: JIS K 7161:1994, JIS K 7162:1994, IS K 7127:1999 are available as JIS compatible with part of ISO527.	Added.	N/A
4.3.13.5	Replace "IEC 60825-1" to "JIS C 6802:2005 or JIS C of this Sub-Clause	Replaced.	N/A
	Replace "IEC 60825-2:2000" to "JIS C 6803:2006 or IEC 60825-2:2000" of this Sub-Clause	Replaced.	N/A
4.5.1	Add the following to Suffix 3) of Table 4B (part one and part two). Note: When data concerning materials is unavailable, Annex 4, 1 (1) 3 of "Regarding Interpretation of Ministerial Ordinance Providing Technical Standards for Electrical Products" (June 19, 2008 Bureau of Commerce No. 3) may be applied to Item 1.	Added.	P

Attachment

The insulating materials shall not be exposed to the temperature exceeding the values when the appliance is operated at rated voltage and normal operating condition.

These values may be increased by;

8 degrees for Duty 2 appliance, and

16 degrees for Duty 3 appliance.

In order to classify the appliances, following assumptions are to be used.

Duty 1 appliances: considered to be connected to supply mains throughout the years such as refrigerators

Duty 2 appliances: considered to be connected to be in between Duty 1 and Duty 3 such as room heaters

Duty 3 appliances: considered to be connected to supply mains when it is operated for rather short time such as portable coffee mill.

Permissible temperature limits of insulating materials

Natural materials	
Material	Permissible temperature limit (°C)
Bituminous compound for filter	75, (105) 1)
Paper, cotton, silk, other natural fiber and wood	90, (105) 2)
Oil denatured natural resin	105

IEC60950_1C - ATTACHMENT			
Clause	Requirement + Test	Result - Remark	Verdict

Silica powder	500
Mica (Hard)	500, (600) 3)
(Soft)	650, (850) 3)

Notes: 1) Value applies to thermal insulating materials.

2) Value applies to materials impregnated with varnish.

3) Value in parenthesis is applied when mechanical external force is absent.

Mica splittings and untreated mica papers

Lining	Adhesive							Permissible Temperature Limit (°C)
	a	b	c	d	e	f	g	
None	X	X	X	X	X			130 155 180; 450, (700) ¹⁾ ; 600, (800) ²⁾ 600, (700) ¹⁾ ; 700, (850) ²⁾
Paper	X	X	X	X				130
Polyethylene terephthalate film				X				130
Glass fabric				X	X		X	130 155 180
Polyester nonwoven fabric, Polyester woven, and Polyethylene naphthalate film				X	X			130 155
Polyamide-imide film, Aramid film, and Polyimide film						X	X	155 180

a: with asphalt base

b: with natural resin or denatured natural resin base

c: with ceramic base

d: with oil-denatured synthetic resin, alkyd orthophthalate resin or cross-linked polyester base.

e: with silicon-denatured synthetic resin, isophthalate alkyd resin, terephthalate alkyd resin or epoxy resin.

f: with silicon resin.

g: inorganic

Notes: 1) value applies to hard mica-made heating substrate.

2) value applies to soft mica-made heating substrate.

Remarks: value in parenthesis is applied when mechanical external force is absent.

Organic materials (Thermosetting Resins)

Material	Permissible temperature limit (°C)
laminated melamine resin mixed with glass fiber	75, (100) ¹⁾
moulded melamine resin mixed with: cellulose inorganics	120 140
laminated phenol resin with: cotton fiber base paper base	115, (85) ²⁾ 120, (70) ³⁾

IEC60950_1C - ATTACHMENT			
Clause	Requirement + Test	Result - Remark	Verdict

polyamide cloth base		75	
inorganics		140	
moulded phenol resin w ith:			
inorganics		150, (160) ¹⁾	
others		140, (150) ¹⁾	
moulded melamine phenol resin w ith the gravity of less than 1.55		130	
moulded urea resin mixed w ith cellulose		90	
unsaturated polyester-casting		120	
laminated unsaturated polyester mixed w ith inorganics		140	
moulded unsaturated polyester mixed w ith:			
other than organics		120	
inorganic powder		140	
glass fiber		155	
epoxy resin-casting		120	
laminated epoxy resin mixed w ith:			
inorganic		130, (140) ¹⁾	
other than inorganics		110, (90) ³⁾	
moulded epoxy resin mixed w ith inorganics		130	
laminated diallyl phthalate resin mixed w ith inorganics		140	
moulded diallyl phthalate resin mixed w ith:			
other than inorganics		130	
inorganic powder		150	
glass fiber		155	
xylene resin-casting		140	
polyamide-imide film		180	
laminated silicone resin mixed w ith inorganics		180, (220) ¹⁾	
moulded silicon resins mixed w ith inorganics		180, (240) ⁴⁾	
polyimide film		210	
laminated polyimide		190	
polybutadiene-casting		120	
moulded polybutadiene mixed w ith inorganics		130	
laminated dipheny oxide mixed w ith inorganics		180	

Notes: 1) Values apply to thermal insulating materials.

2) Values apply to materials w ith a thickness less than 0.8 mm.

3) Values apply to materials w ith a thickness less than 0.8 mm w hen treated to retard flame.

4) Values apply to materials used for thermal insulation and to seal outlets of sheathed heating w ires.

Organic materials (Thermoplastic Resins)

Material	Permissible temperature limit (°C)
methacrylic resin, cellulose resin, cellulose acetate butylate resin, ulcanise, polyethylene	50
foamed polyethylene compound for insulated conductors, polyvinyl chloride	60
polyethylene compound for insulated conductors, heat-resistant polyvinyl chloride, cross-linked polyvinyl chloride compound for insulated conductors	75
cross-linked polyethylene, chlorinated polyethylene compound for insulated conductors	90
acrylonitrile acrylic rubber styrene resin, acrylonitrile chlorinate polyethylene styrene	55

IEC60950_1C - ATTACHMENT			
Clause	Requirement + Test	Result - Remark	Verdict

resin			
acrylonitrile styrene resin, acrylonitrile butadiene resin, acrylonitrile butadiene chlorinated polyethylene resin	: general : reinforced with glass fiber	55 80	
polypropylene	: general : reinforced with glass fiber	105, (85) ³⁾ 110	
denatured polyphenylene oxide	: general : reinforced with glass fiber	75 100	
Polystyrene		50, (70) ¹⁾	
polyacetal	: general : reinforced with glass fiber	100 120	
polyamide	: general : reinforced with glass fiber	90 120	
polycarbonate	: general : reinforced with glass fiber	110 120	
polyethylene terephthalate	: general : reinforced with glass fiber	120 130	
polybutylene terephthalate	: general : reinforced with glass fiber	120 135	
heat resistant polyethylene terephthalate film		135	
fluorinated polyvinylidene compound for insulated conductors, polychlorotrifluoroethylene (ethylene-trifluoride resin), ethylene-tetrafluoroethylene copolymer for insulated conductors		150	
tetrafluoroethylene hexafluoropropylene resin		200	
polytetrafluoroethylene(ethylene-tetrafluoride), perfluoroalkoxy compound for insulated conductors		250	
aramide(aromatic polyamide paper)		220	
Polysulfone		140, (150) ²⁾	
polyethylene naphthalate		155	
polyallylate	: general : reinforced with glass fiber	120 130	

Notes : 1) Values apply to capacitor dielectrics.

2) Values apply to thermal insulating material

3) Values apply to materials with a thickness of less than 0.8 mm

4) Inorganic materials

Inorganic materials

Material	Permission temperature limit (°C)
glass fiber (only alkaline free)	300
lead glass	380
borosilicate glass	490
quartz glass	800
ceramic	800, (1000) ¹⁾

Note: 1) Value apply to materials used as electric heating elements

Rubber compounds

IEC60950_1C - ATTACHMENT			
Clause	Requirement + Test	Result - Remark	Verdict

Material	Permission temperature limit (°C)
natural rubber, polyurethane rubber, ebonite	60
nitrile rubber, styrene butadiene rubber, chloroprene rubber	75
butyl rubber	80
ethylene propylene (diene) rubber, chlorosulfonated polyethylene rubber	90
silicone rubber	180, (200) ¹⁾

Note : 1) Value apply to thermal insulating material and sealing compounds for sheathed heating elements.

Sleeves, Cloth, Tapes and like

Material	Impergnat or coating	Permission temperature limit (°C)
rayon, cellulose acetate, vinylon	adhesive, oil varnish	105
paper, cotton fabric, silk fabric, polyamide, polyester fabric, polyester nonw oven fabric	oil varnish	105
polyester fabric, polyester nonw oven fabric	alkyd resin varnish	120
glass fabric	(ditto)	130
paper	Iso or terephthalate alkyd resin varnish, epoxy resin varnish, alkyd resin varnish	105
polyester fabric, polyester nonw oven fabric	(ditto)	120
glass fabric, aramide paper	Iso or terephthalate, alkyd resin varnish, epoxy resin varnish, silicone resin varnish, silicone rubber	155 180
vulcanised fiber		105
heat resistant fiber		120

5.1.3	Add the following NOTE Note: Note that domestic three-phase power distribution systems have many delta connections, in which case tests should be performed using IEC 60990:1990 Figure 13 test circuitry.	Added.	N/A
5.1.6 Table 5A	Replace Table 5A of this Sub-Clause by:	Replaced. The equipment is "Protection Class I".	P
Table 5A – Maximum current			
	Type of equipment	Terminal A of measuring instrument connected to:	Maximum TOUCH CURRENT mA r.m.s. ¹⁾
			Maximum PROTECTIVE CONDUCTOR CURRENT

IEC60950_1C - ATTACHMENT			
Clause	Requirement + Test	Result - Remark	Verdict
	ALL equipment	Accessible parts and circuits not connected to protective earth	0,25 -
	HAND-HELD	Equipment main protective earthing terminal (if any) CLASS I EQUIPMENT	0,75 -
	MOVABLE (other than HAND-HELD, but including TRANSPORTABLE EQUIPMENT		3,5 -
	STATIONARY, PLUGGABLE TYPE A		3,5 -
	ALL other STATIONARY EQUIPMENT not subject to the conditions of 5.1.7		3,5 -
	- subject to the conditions of 5.1.7		- 5 % of input current
	HAND-HELD	Equipment main protective earthing terminal	0,5 -
	Others	(if any) CLASS 0I EQUIPMENT	1,0 -
	*) If peak values of TOUCH-CURRENT are measured, the maximum values obtained by multiplying the r.m.s. values by 1,414.		
6	Add the following after NOTE1 of this Sub-Clause. Refer to the accompanying document, JB, for details concerning appropriate additional measures, Replace "IEC 60664-1" to "JIS C 0664 in note 4	Added. Replaced.	N/A N/A
7	Replace "IEC 60664-1" to "JIS C 0664:2003 of this NOTE 3	Replaced.	N/A
7.2	Add the following However, when all of the following criteria are satisfied, the separation requirement and test in 6.2.1 a), b) and c) shall not be applied to the cable distribution system. - the applicable circuit is a TNV-1 circuit. - the applicable circuit's common side or grounding side is connected to the coaxial cable shielding, and to all accessible parts and circuits (SELV circuits, accessible metal parts, and limited current circuits also applicable if they exist) - the external conductor of the coaxial cable is intended to be connected to the grounding wire used for building wiring.	Added.	N/A
Annex G 2.1	Replace "IEC 60664-1" to "JIS C 0664:2003"	Replaced.	N/A
Annex G 6	Replace "IEC 60664-1" to "JIS C 0664:2003"	Replaced.	N/A
Annex N	Add Note Note: ITU-T Recommendation K.17:1996 has been abolished and replaced with ITU-T Recommendation K.44:2003, K.45:2003.	Added.	N/A

IEC60950_1C - ATTACHMENT			
Clause	Requirement + Test	Result - Remark	Verdict
	Note: The ITU-T Recommendation K.21:1996 test circuit was replaced with K.44:2003 in July 2003.		N/A
Annex P	Add the following terms. <u>JIS C 5101-14:1998 Fixed capacitors for use in electronic equipment -- Part 14: Type-specific standards: Fixed capacitors for electromagnetic interference suppression in electrical power supply</u> Fixed capacitors for use in electronic equipment – Part 14: Sectional specification: Fixed capacitors for electromagnetic interference suppression and connection to the supply mains	Added.	N/A
	Replace “IEC 60065:1998” to “IEC 60065:2001”	Replaced.	N/A
	Add the following terms. JIS C 6802:2005	Added.	N/A
	Add the following terms. JIS C 6803:2006 2004.	Added.	N/A
	Add the following terms. JIS C 8303:2007	Added.	N/A
	Add the following terms. JIS S 0101:2000	Added.	N/A
	Add the following terms. ITU-T Recommendation K.44:2003 , Resistibility tests for telecommunication equipment exposed to overvoltages and overcurrents – Basic Recommendation.	Added.	N/A
	Add the following terms. ITU-T Recommendation K.45:2003 , Resistibility of telecommunication equipment installed in the access and trunk networks to overvoltages and overcurrents.	Added.	N/A
Annex Q	Add the following terms. ITU-T Recommendation K.66:2004 , Protection of customer premises from overvoltages.	Added.	N/A
Annex T	Replace “IEC 60529:1989” to “JIS C 0920:2003	Replaced.	N/A
Annex W.1	Add following. Equipment, Class 0I	Added.	P

IEC60950_1C - ATTACHMENT			
Clause	Requirement + Test	Result - Remark	Verdict
Annex JA	Add Annex JA (Document shredding machines) Document shredding machines shall also comply with the requirements of this annex except those of STATIONARY EQUIPMENT used by connecting directly to an AC MAINS SUPPLY of three-phase 200V or more.	Added. Not Document shredding machines.	N/A
JA.1	<p>Markings and instructions <i>In the easily visible part near the document-slot, by a method capable to make out clearly and not easily disappeared, and by easily understandable wording, shall indicate the symbol of;</i></p> <p></p> <p>and, also the following precautions for use; that use by an infant/child may cause a hazard of injury etc.;</p> <p>that a hand can be drawn into the mechanical section for shredding when touching the document-slot;</p> <p>that clothes can be drawn into the mechanical section for shredding when touching the document-slot;</p> <p>that hairs can be drawn into the mechanical section for shredding when touching the document-slot;</p> <p>in case of equipment incorporating a commutator motor, that equipment may catch fire or explode by spraying of flammable gas.</p>	Added. Not Document shredding machines.	N/A
JA.2	<p>Inadvertent reactivation</p> <p>Any safety interlock which can be operated by means of the test finger, Figure JA.1, is considered to cause reactivation of the hazard.</p> <p>Compliance is checked by inspection and, where necessary, by a test with the test finger, Figure JA.1.</p>	Added. Not Document shredding machines.	N/A

IEC60950_1C - ATTACHMENT			
Clause	Requirement + Test	Result - Remark	Verdict

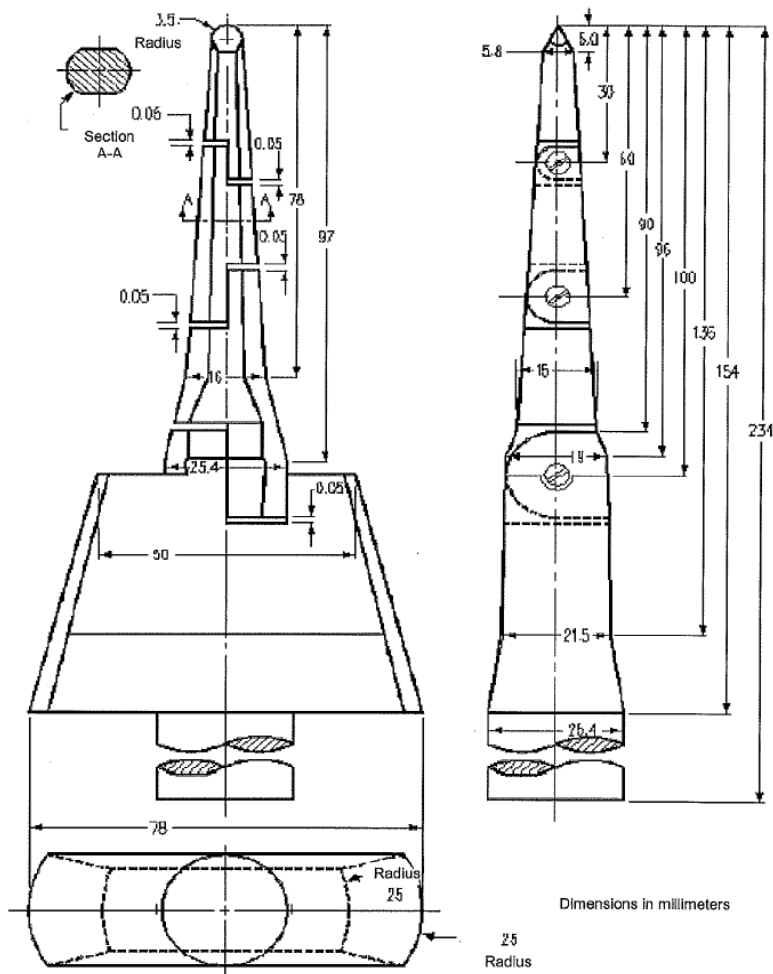
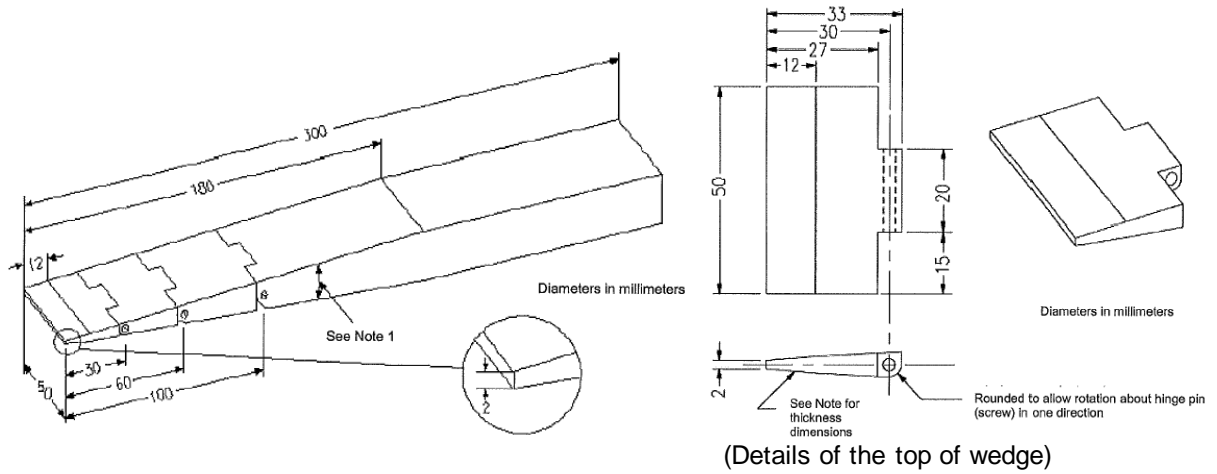

Figure JA.1 Test finger

IEC60950_1C - ATTACHMENT			
Clause	Requirement + Test	Result - Remark	Verdict
JA.3	<p style="text-align: center;">Isolating switch</p> <p>Document shredding machines shall incorporate an isolating switch complying with sub-clause 3.4.2 as the device disconnecting the power of hazardous moving parts. For this switch, two-position (single-use) switch or multi-position (multifunction) switch (e.g., slide switch) may be used.</p> <p>If two-position switch, the positions for "ON" and "OFF" shall be indicated in accordance with sub-clause 1.7.8. If multi-position switch, the position for "OFF" shall be indicated in accordance with sub-clause 1.7.8 and other positions shall be indicated with proper terms or symbols.</p> <p>Compliance is checked by inspection.</p>	Added. Not Document shredding machines.	N/A
JA.4	<p style="text-align: center;">Protection in operator access areas</p> <p>Any warning shall not be used instead of the structure for preventing access to hazardous moving parts.</p> <p>Document shredding machines shall comply with the following requirements.</p> <p>Push the test finger, Figure JA.1, into all openings in MECHANICAL ENCLOSURES without applying additional force. It shall not be possible to touch hazardous moving parts with the test finger. The document shredding machine is installed as intended, and all face of MECHANICAL ENCLOSURES are subjected to this test. Before testing with the test finger, remove the parts detachable without a tool.</p> <p>Push the wedge-probe, Figure JA.2, into the document-slot. And, against all directions of openings, if straight-cutting type, a force of 45 N shall apply to the probe, and 90 N if cross-cutting type. In this case, the weight of the probe shall not influence the test. Before testing with the test finger, remove the parts detachable without a tool. It shall not be possible to touch any hazardous moving parts, including the shredding roller or the mechanical section for shedding, with the probe.</p>	Added. Not Document shredding machines.	N/A

IEC60950_1C - ATTACHMENT			
Clause	Requirement + Test	Result - Remark	Verdict



Distance from the top	Thickness of probe
0	2
12	4
180	24

Note 1 - The probe shall be of changing the thickness linearly. However, the slope shall

be changed at the respective points shown in the table.

Note 2 -The allowable dimensional tolerance of the probe is +/- 0.127 mm.

Figure JA.2 Wedge-probe

Annex JB (reference)	Add Annex JB (Current state and means of handling overvoltage and overcurrent in the installation environment) The objective of this reference is not to propose new technical standards for the device. As a means of reducing the possibility that voltages in excess of 1.5kV peak may be applied to the device, these specifications provide for matters that must be adhered to concerning the device on the premise that it is installed in an environment within which appropriate measures have been taken in accordance with "ITU-T Recommendation K.11:1993". However, since environments that are not commensurate with this K.11 are often discovered domestically, this document attempts to describe the preferred environment and demonstrate the means for developing the preferred installation environment, thus contributing to its enhancement.	Added.	N/A
JB.1	JB.1 Preferred installation environment		N/A
JB.2	Current state and means of handling overvoltage and overcurrent in the installation environment		N/A

IEC60950_1C - ATTACHMENT			
Clause	Requirement + Test	Result - Remark	Verdict
Appendix	J3000 (H21) Special National conditions, National deviation and other information according to MITI Ordinance No. 85.		—
1	General requirement When equipment provides with appliance inlet complying with JIS-C 8283-1(2008), soldered parts of appliance inlet is not applied by force during insert or removal of connector. This is not applied when inlet body is fixed itself and not fixed by solder.	Inlet is fixed by adequate mechanical construction, not rely on soldering.	P
2	Requirement for equipment		—
2.1	Electric heater When diode is used in parallel for adjustment of power, the equipment shall remain safe for operation under open condition of one diode.	Not electric stove.	N/A
	The current rating of one diode shall be more than main current. The diodes connected in parallel are same type.		N/A
	The heating test specified by clause 11 of JIS C 9335-2-30(2006) under open condition of one diode shall comply with the requirements.		N/A
2.2	Electric heater with glowing heating elements	Not electric stove.	N/A
	Surface treatment by paint or adhesive on protective frame or protective mesh shall not be used.		N/A
	Caution marking like below shall be on - easily visible place of the equipment or - Instruction manual 「注意 当該機器から、使用初期段階で揮発性有機化合物およびカルボニル化合物が最も放散するおそれがあるため、その際には十分換気を行うこと。」		N/A
3	Components used in equipment	No relevant equipment or component.	N/A
3.1	Motor capacitors used in air conditioner, electric washing machine, refrigerator or electric freezer shall be comply with - capacitors with protective elements or protective mechanism complying with JIS C 4908(2007) - P2 capacitor complying with IEC 60252-1(2001) Capacitor complying with below is acceptable		N/A
	Enclosed by metal or ceramic		N/A

IEC60950_1C - ATTACHMENT

Clause	Requirement + Test	Result - Remark	Verdict
	No non-metallic materials within 50 mm from capacitor surface		N/A
	Non-metallic material within 50 mm from capacitor surface comply with needle frame test of JIS C 9335-1(2003), Annex E		N/A
	Non-metallic material within 50 mm from capacitor surface comply with V-1 test of JIS C 60965-11-10(2006).		N/A
3.2	Plug directly inserted to outlet used refrigerator or electric freezer. Shall comply with <ul style="list-style-type: none"> - Face contact with outlet shall have CTI with more than 400 according to JIS C 2134(2007) or - Supporting material of blades shall comply with glow wire test by temperature of 750°C according to JIS C 60695-2-11(2004) or JIS C 60695-2-12(2004). Materials having glow wire frame temperature of 775 °C are acceptable.		N/A

Type Designation: See test report
Report Number: 17028284 001



Figure 1. Model 185LM000**



Figure 2. Model 185LM000**

Type Designation: See test report
Report Number: 17028284 001



Figure 3. Model 185LM000**



Figure 4. Model 185LM000**

Type Designation: See test report
Report Number: 17028284 001



Figure 5. Model 215LM000**



Figure 6. Model 215LM000**

Type Designation: See test report
Report Number: 17028284 001

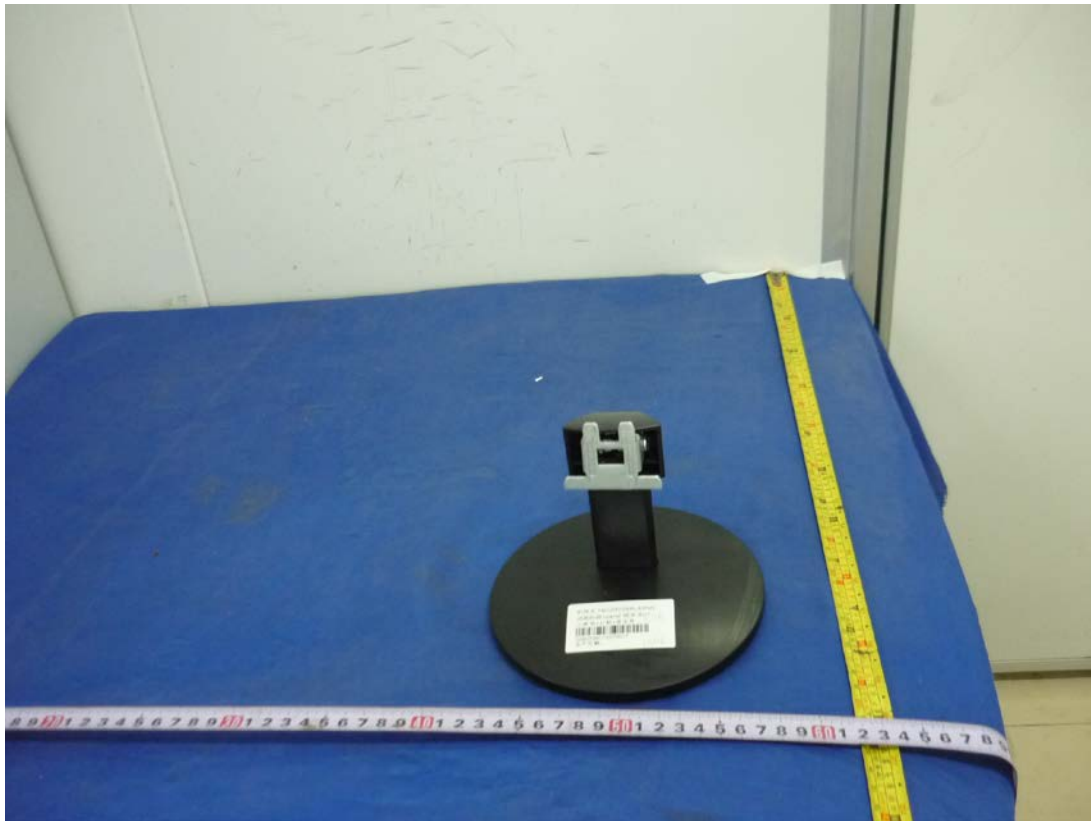

Figure 7.



Figure 8.

Type Designation: See test report
Report Number: 17028284 001

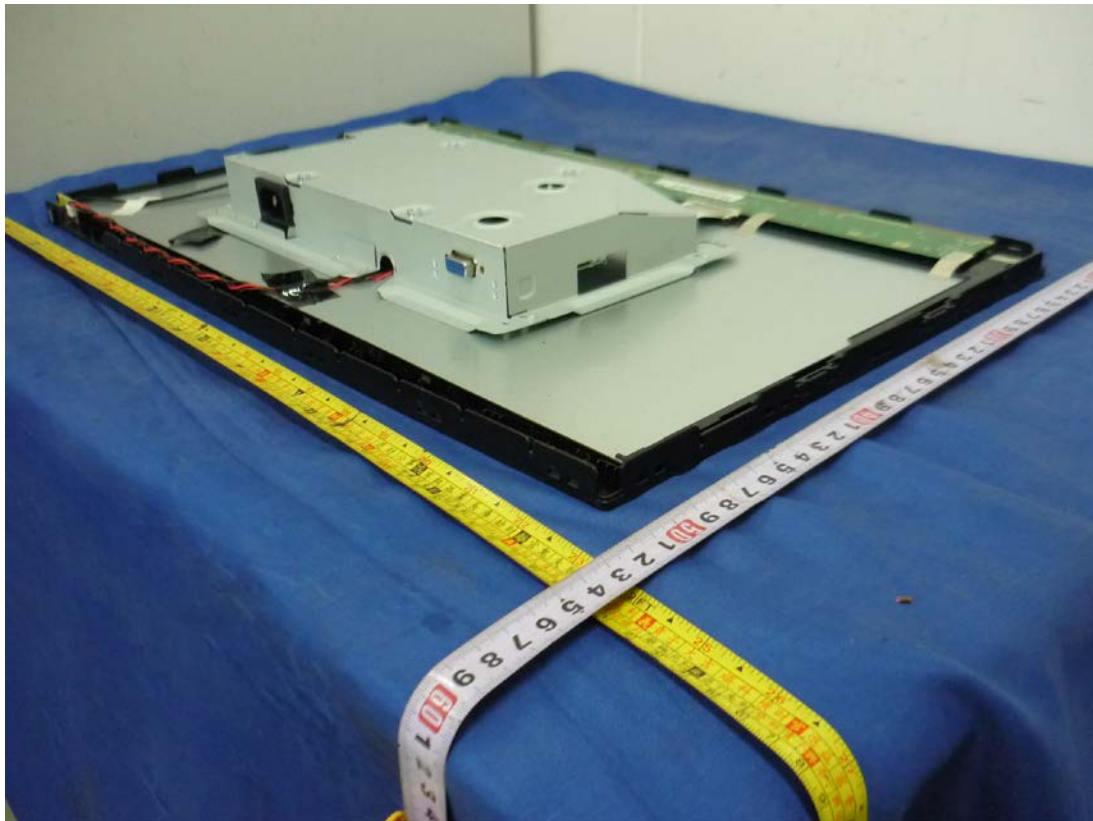

Figure 9.



Figure 10.

Type Designation: See test report
Report Number: 17028284 001

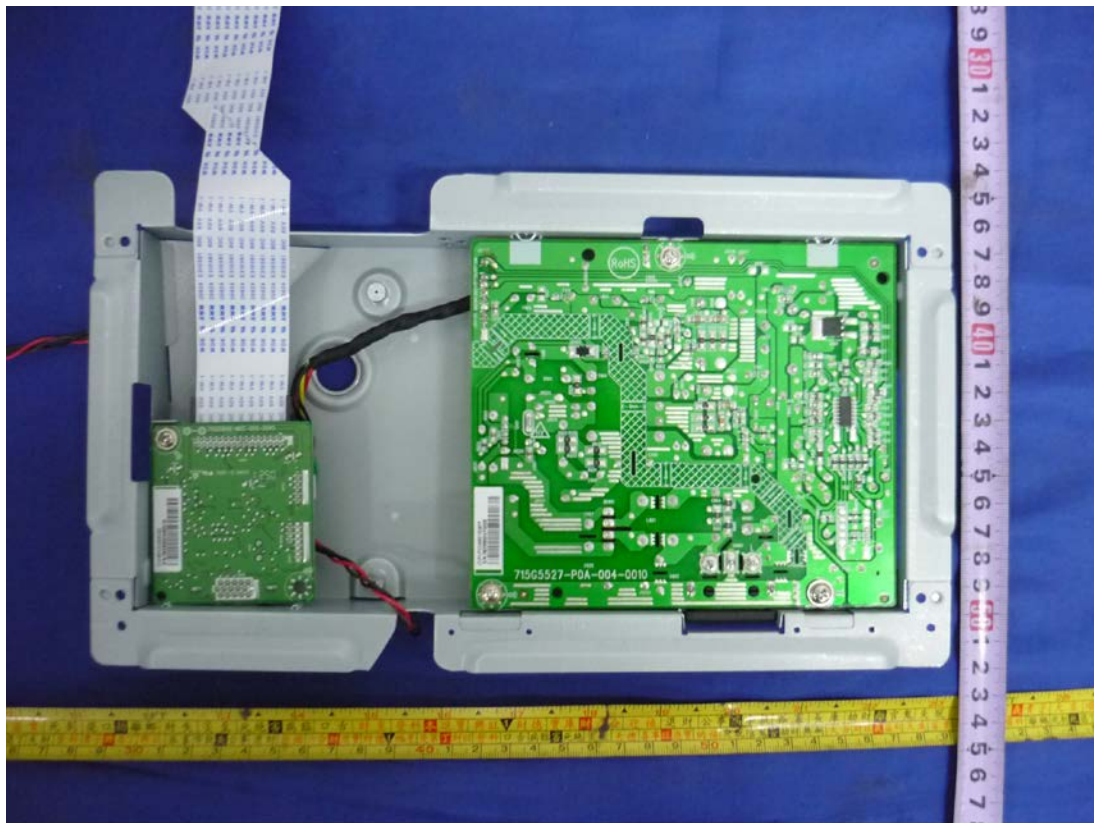

Figure 11.

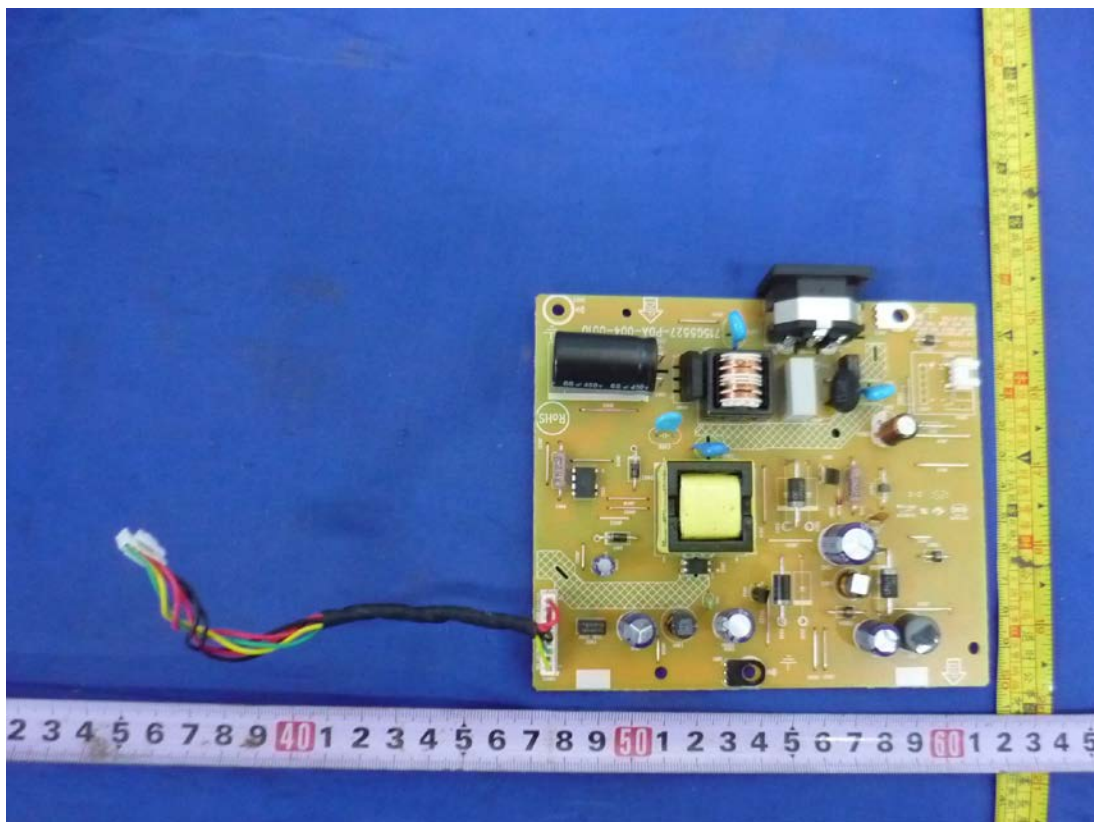

Figure 12.

Type Designation: See test report
Report Number: 17028284 001

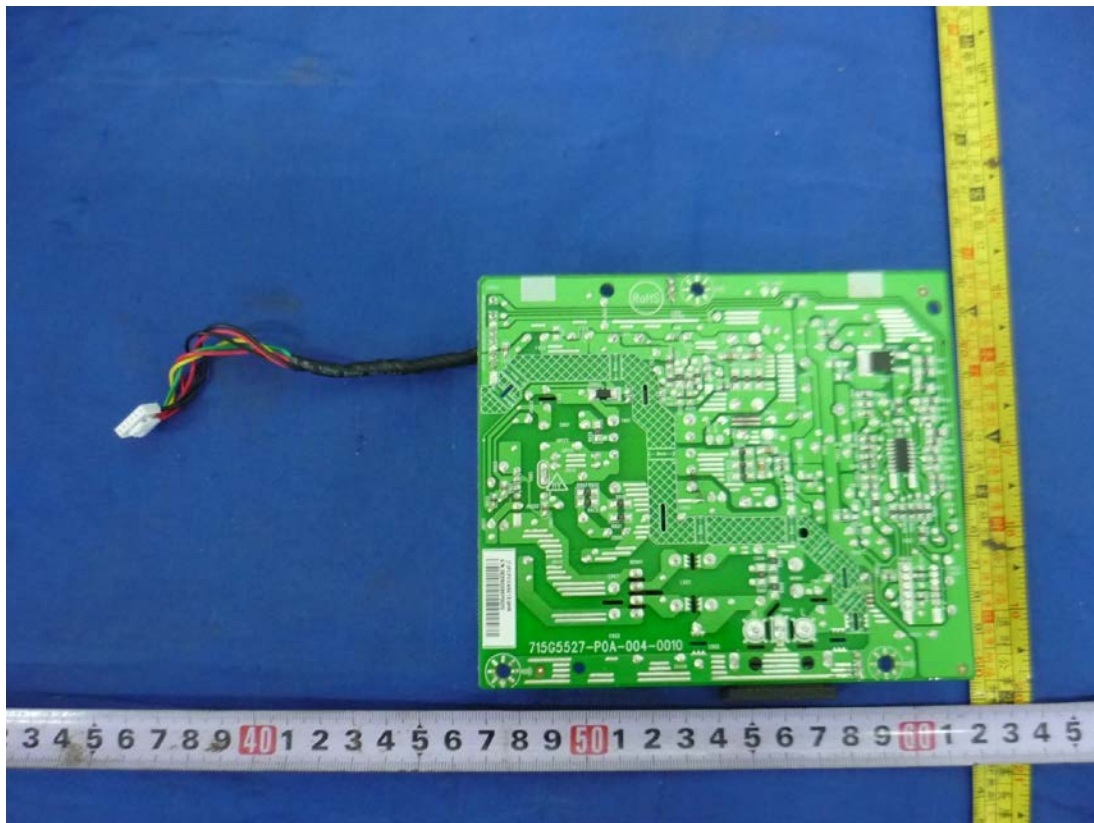

Figure 13.

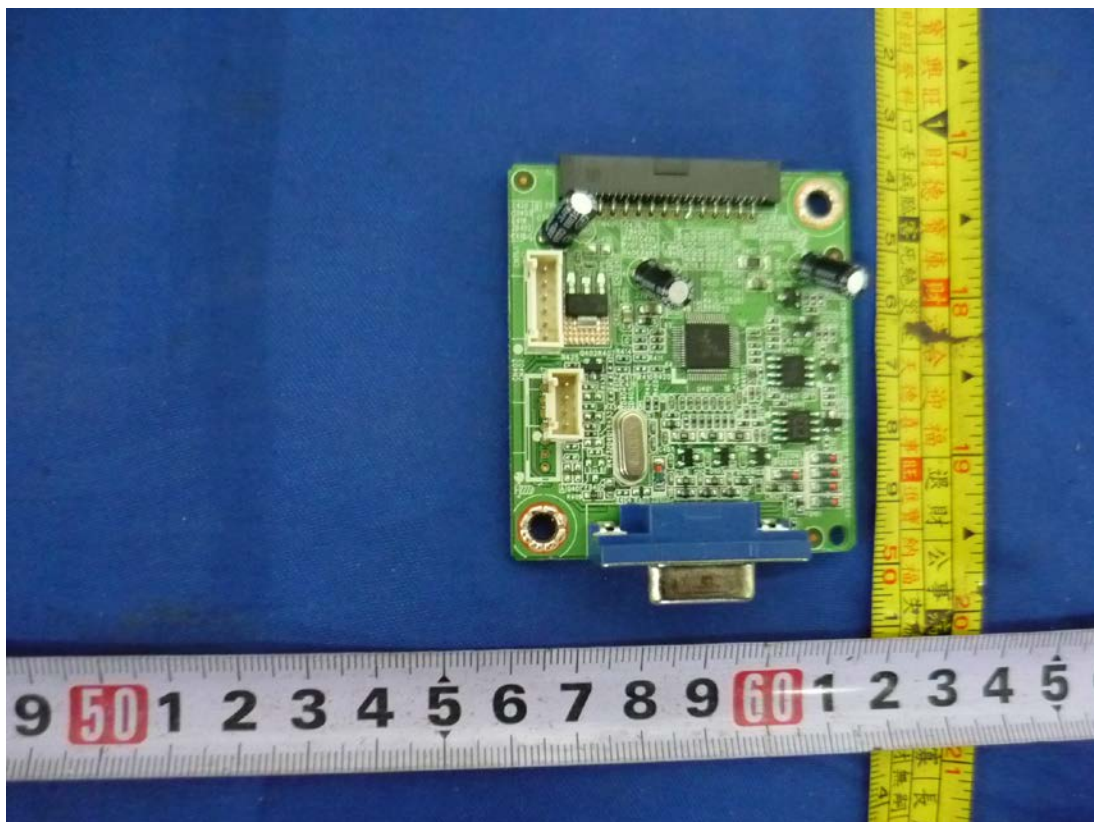

Figure 14. Main board 715G5965

Type Designation: See test report
Report Number: 17028284 001

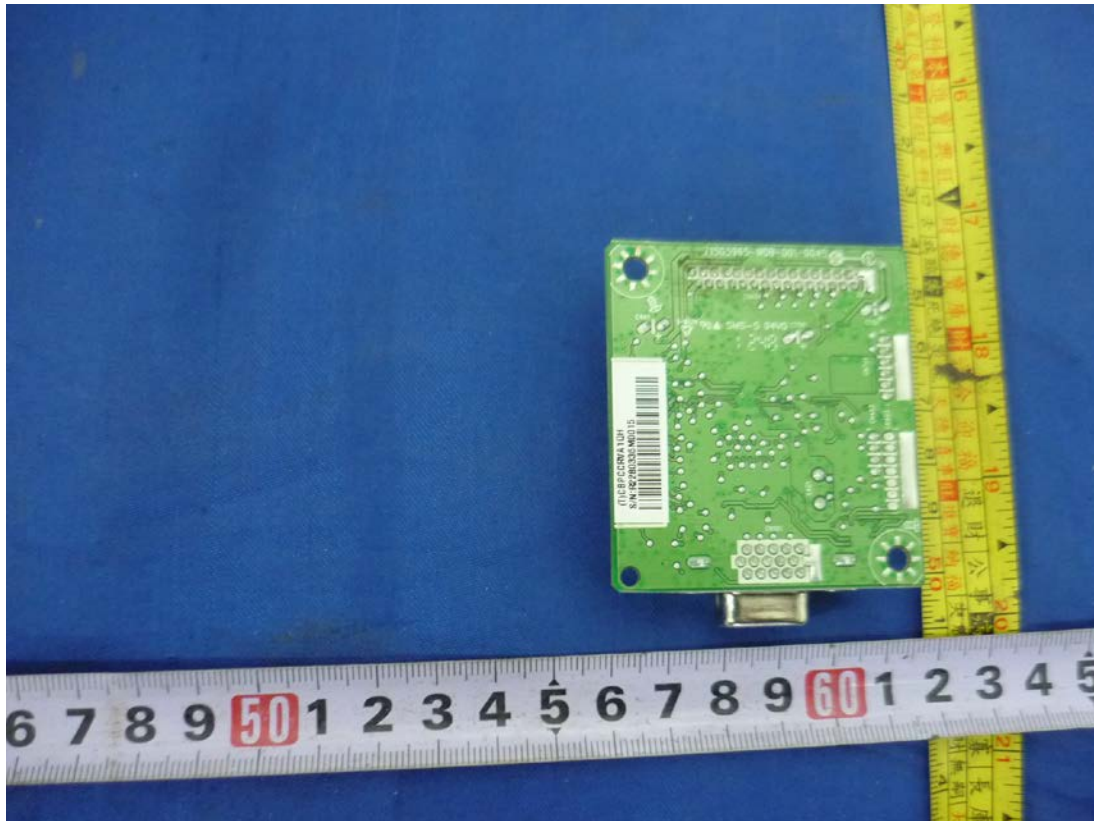

Figure 15. Main board 715G5965

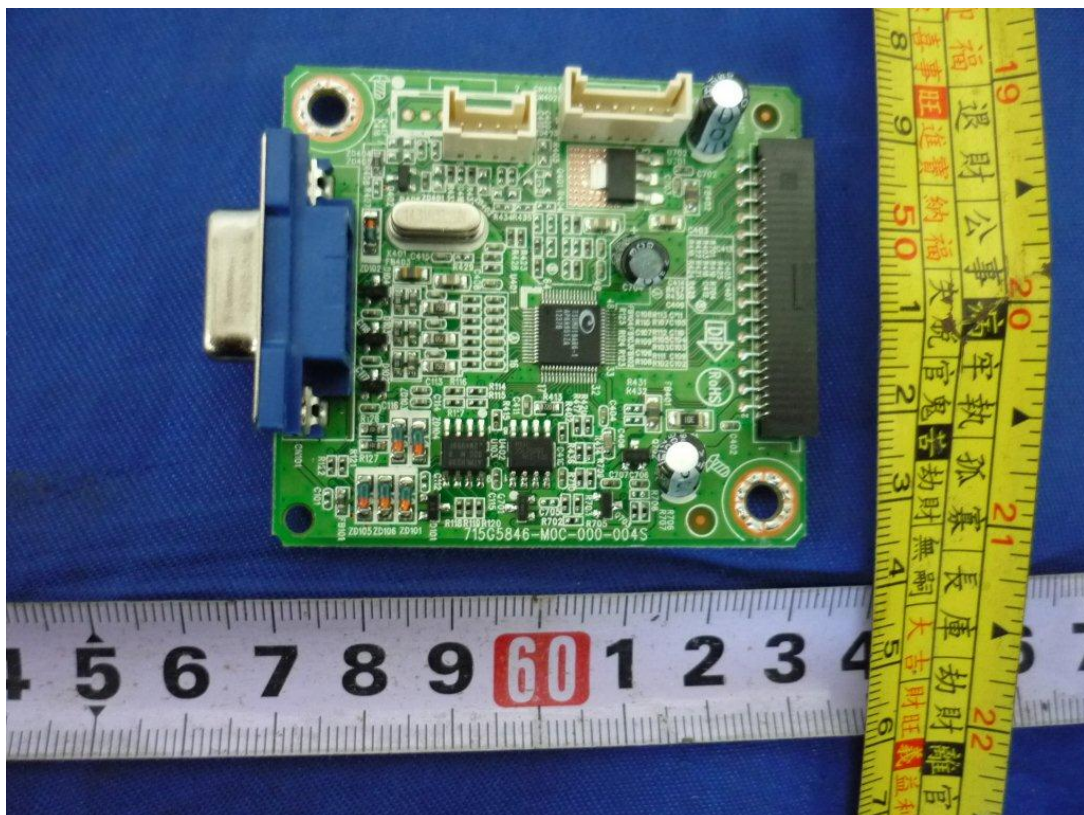

Figure 16. Main board 715G5846

Type Designation: See test report
Report Number: 17028284 001

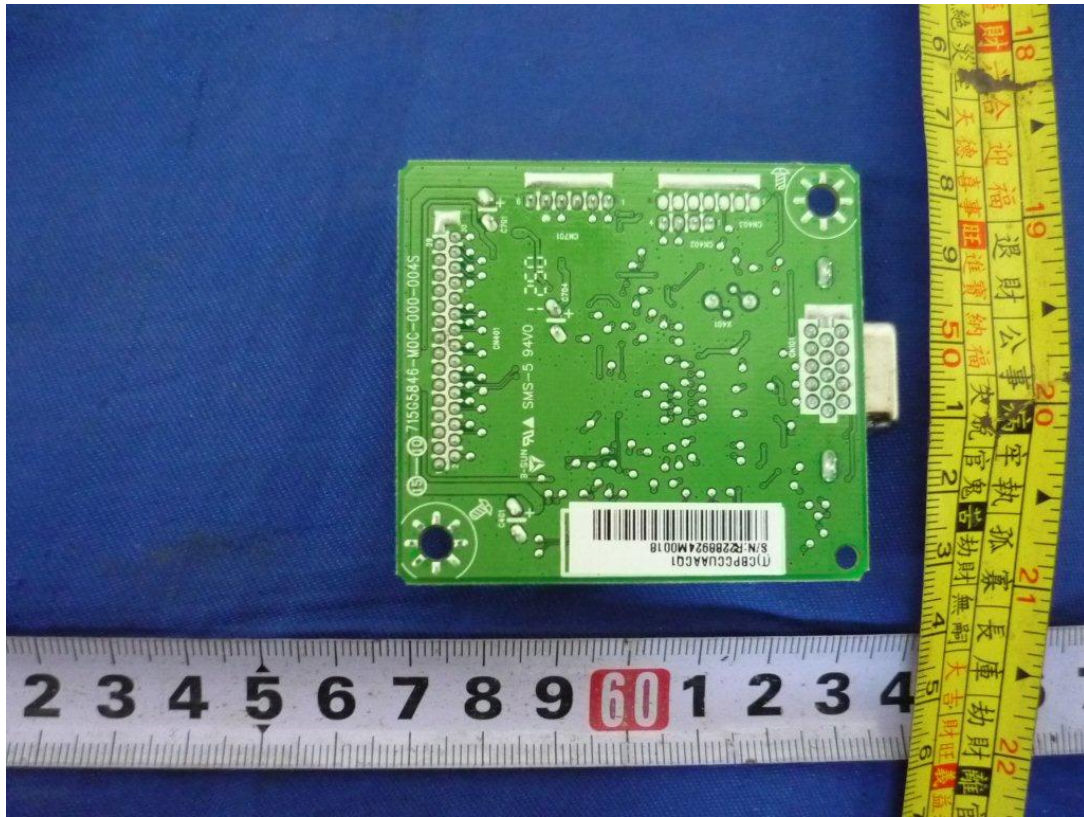

Figure 17. Main board 715G5846