



EMC TEST REPORT

Authorized under Declaration of Conformity

According to

EN 55022 : 2010/AC:2011 (Class B)	EN 55024 : 2010
EN61000-3-2:2006+A1:2009+A2:2009	IEC 61000-4-2 : 2008
EN 61000-3-3 : 2013	IEC 61000-4-3 : 2006+A1:2007+A2:2010
CISPR 22 : 2008	IEC 61000-4-4 : 2012
AS/NZS CISPR 22 : 2009+A1(2010)	IEC 61000-4-5 : 2005
	IEC 61000-4-6 : 2008
	IEC 61000-4-8 : 2009
	IEC 61000-4-11 : 2004

Applicant : TPV Electronics (Fujian) Co., Ltd.
Address : Rongqiao Economic and Technological
Development Zone, Fuqing City, Fujian
Province, P.R. China
Equipment : LCD Monitor
Model No. : G2260VWQ6, *2260*****
The "*" could be any alphanumeric character including blank for marketing differentiation.

I HEREBY CERTIFY THAT :

The sample was received on Jun. 09, 2015 and the testing was carried out on Jun. 17, 2015 at CerpPASS Technology Corp. The test result refers exclusively to the test presented test model / sample. Without written approval of CerpPASS Technology Corp., the test report shall not be reproduced except in full.



EMC TEST REPORT

Issued by:

CerpPASS Technology (Suzhou) Co.,Ltd

No.66,Tangzhuang Road, Suzhou Industrial Park, Jiangsu 215006, China

Tel:86-512-6917-5888

Fax:86-512-6917-5666

The test record, data evaluation & Equipment Under Test configurations represented herein are true and accurate accounts of the measurements of the samples EMC characteristics under the conditions specified in this report.

The above equipment was tested by CerpPASS Technology Corp. for compliance with the requirements of technical standards specified above under the EMC Directive **2004/108/EC & 2014/30/EU**. The results of testing in this report apply only to the product/system, which was tested. Other similar equipment will not necessarily produce the same results due to production tolerance and measurement uncertainties

Approved by:

Miro Chueh
EMC/RF B.U. Manager

Laboratory Accreditation:

CerpPASS Technology Corporation Test Laboratory

NVLAP LAB Code:	200954-0
TAF LAB Code:	1439

CerpPASS Technology(SuZhou) Co., Ltd.

NVLAP LAB Code:	200814-0
CNAS LAB Code:	L5515



Contents

1. Summary of Test Procedure and Test Results	6
2. Immunity Testing Performance Criteria Definition	7
3. Test Configuration of Equipment under Test	8
3.1. Feature of Equipment under Test.....	8
3.2. Test Mode and Test Manner	9
3.3. Description of Support Unit.....	10
3.4. General Information of Test	11
3.5. Measurement Uncertainty	12
4. Test of Conducted Emission	14
4.1. Test Limit	14
4.2. Test Procedures	15
4.3. Typical Test Setup.....	15
4.4. Measurement equipment.....	16
4.5. Test Data and Result.....	17
4.6. Test Photographs of Power Port.....	24
5. Test of Radiated Emission	25
5.1. Test Limit	25
5.2. Test Procedures	26
5.3. Typical test Setup.....	26
5.4. Measurement equipment.....	27
5.5. Test Result and Data (30MHz ~ 1000MHz).....	28
5.6. Test Result and Data (1000MHz ~ 6000MHz).....	34
5.7. Test Photographs (30MHz ~ 1000MHz).....	40
5.8. Test Photographs (1000MHz ~ 6000MHz).....	41
6. Harmonics Test	42
6.1. Limits of Harmonics Current Measurement.....	42
6.2. Measurement equipment.....	43
6.3. Test Result and Data.....	44
6.4. Test Photographs.....	46
7. Voltage Fluctuations Test	47
7.1. Test Procedure.....	47
7.2. Measurement equipment.....	47
7.3. Test Result and Data.....	48
7.4. Test Photographs.....	50
8. Electrostatic Discharge Immunity Test	51
8.1. Test Procedure.....	51
8.2. Test Setup for Tests Performed in Laboratory	52
8.3. Test Severity Levels	53
8.4. Measurement equipment.....	53
8.5. Test Result and Data.....	54



8.6. Test Photographs 55

9. Radio Frequency electromagnetic field immunity test 56

9.1. Test Procedure..... 56

9.2. Test Severity Levels 56

9.3. TEST SETUP 57

9.4. Measurement equipment..... 58

9.5. Test Result and Data 59

9.6. Test Photographs 60

10. Electrical Fast Transient/ Burst Immunity Test 61

10.1. Test Procedure..... 61

10.2. Test Severity Levels 61

10.3. TEST SETUP 62

10.4. Measurement equipment..... 62

10.5. Test Result and Data 63

10.6. Test Photographs 64

11. Surge Immunity Test 65

11.1. Test Procedure..... 65

11.2. Test Severity Level 65

11.3. TEST SETUP 66

11.4. Measurement equipment..... 66

11.5. Test Result and Data 67

11.6. Test Photographs 68

12. Conduction Disturbances induced by Radio-Frequency Fields 69

12.1. Test Procedure..... 69

12.2. Test Severity Levels 69

12.3. TEST SETUP 70

12.4. Measurement equipment..... 71

12.5. Test Result and Data 72

12.6. Test Photographs 73

13. Power Frequency Magnetic Field Immunity Tests 74

13.1. Test Setup 74

13.2. Test Severity Levels 74

13.3. Measurement equipment..... 74

13.4. Test Result and Data 75

13.5. Test Photographs 76

14. Voltage Dips and Voltage Interruptions Immunity Test Setup 77

14.1. Test Conditions 77

14.2. TEST SETUP 77

14.3. Measurement equipment..... 77

14.4. Test Result and Data 78

14.5. Test Photographs 79

15. Photographs of EUT 80

**1. Summary of Test Procedure and Test Results**

EMISSION [EN 55022: 2010/AC:2011]			
Standard	Item	Result	Remarks
EN55022: 2010/AC:2011 AS/NZS CISPR 22 : 2009+A1(2010) CISPR 22 : 2008	Conducted (Power Port)	PASS	Meet Class B Limit Minimum passing margin(QP) is -10.17 dB at 1.9420 MHz
	Conducted (Telecom port)	N/A	N/A
	Radiated	PASS	Meets Class B Limit Minimum passing margin(QP) is -4.01 dB at 634.3099 MHz
EN 61000-3-2: 2006+A1:2009+A2:2009	Harmonic current emissions	PASS	Meet Class D Limit
EN61000-3-3:2013	Voltage fluctuations & flicker	PASS	Meets the requirements

IMMUNITY [EN 55024:2010]			
Standard	Item	Result	Remarks
IEC 61000-4-2: 2008	ESD	PASS	Meets the requirements of Performance Criterion A
IEC 61000-4-3: 2006+A1:2007+A2:2010	RS	PASS	Meets the requirements of Performance Criterion A
IEC 61000-4-4: 2012	EFT	PASS	Meets the requirements of Performance Criterion A
IEC 61000-4-5:2005	Surge	PASS	Meets the requirements of Performance Criterion A
IEC 61000-4-6:2008	CS	PASS	Meets the requirements of Performance Criterion A
IEC 61000-4-8:2009	PFMF	PASS	Meets the requirements of Performance Criterion A
IEC 61000-4-11:2004	Voltage dips & voltage variations	PASS	Meets the requirements of Voltage Dips: 1) >95% reduction Performance Criterion B 2) 30% reduction Performance Criterion B Voltage Interruptions: 1) >95% reduction Performance Criterion C



2. Immunity Testing Performance Criteria Definition

Criteria A:	The apparatus shell continues to operate as intended without operator intervention. No degradation of performance or loss of function is allowed below a performance level specified by the manufacturer, when the apparatus is used as intended. The performance level may be replaced by a permissible loss of performance. If the manufacturer does not specify the minimum performance level or the permissible performance loss, then either of these may be derived from the product description and documentation, and by what the user may reasonably expect from the equipment if used as intended.
Criteria B:	After test, the apparatus shell continues to operate as intended without operator intervention. No degradation of performance or loss of function is allowed, after the application of the phenomenon below a performance level specified by the manufacturer, when the apparatus is used as intended. The performance level may be replaced by a permissible loss of performance. During the test, degradation of performance is however allowed. However, no change of operating state if stored data is allowed to persist after the test. If the manufacturer does not specify the minimum performance level or the permissible performance loss, then either of these may be derived from the product description and documentation, and by what the user may reasonably expect from the equipment if used as intended.
Criteria C:	Temporary loss of function is allowed, provided the functions is self-recoverable or can be restored by the operation of controls by the user in accordance with the manufacturer instructions. Functions, and/or information stored in non-volatile memory, or protected by a battery backup, shall not be lost.



3. Test Configuration of Equipment under Test

3.1. Feature of Equipment under Test

Product Name:	LCD Monitor
Model Name:	G2260VWQ6, *2260***** The "*" could be any alphanumeric character including blank for marketing differentiation.
Housing material:	Plastic case
EUT Highest Frequency:	148.5MHz
EUT Power Rating:	Input:100-240V,50-60Hz 3Pin Power Port
AC Power Cord Type:	Non-shielded, 1.2m&1.5m&1.8m

Note: Please refer to user manual.

I/O PORT:

I/O PORT TYPE	Quantity
A. VGA Port	1
B. HDMI Port	1
C. Audio Port	2
D. Display Cable	1



3.2. Test Mode and Test Manner

Test Manner

- a During testing, the interface cables and equipment positions were varied according to Europe Standard.
- b Running "H" pattern.
- c During the test, connect the PC, USB keyboard, USB Mouse, Earphone and EUT, make the EUT at the test mode.
- d Adjust the EUT, then test.

The pre-test modes

Test Mode 1: Full system (VGA mode 1920*1080@60Hz)

Test Mode 2: Full system (VGA mode 1280*1024@75Hz)

Test Mode 3: Full system (VGA mode 640*480@60Hz)

Test Mode 4: Full system (HDMI mode 1920*1080@60Hz)

Test Mode 5: Full system (HDMI mode 1280*1024@75Hz)

Test Mode 6: Full system (HDMI mode 640*480@60Hz)

Test Mode 7: Full system (Display mode 1920*1080@75Hz)

Test Mode 8: Full system (Display mode 1280*1024@75Hz)

Test Mode 9: Full system (Display mode 640*480@60Hz)

Test Mode 10: Full system (1080P from DVD mode)

The worse case was selected as the final test mode and record in the report

Test Mode 1: Full system (VGA mode 1920*1080@60Hz)

Test Mode 4: Full system (HDMI mode 1920*1080@60Hz)

Test Mode 7: Full system (Display mode 1920*1080@75Hz)



3.3. Description of Support Unit

No.	Device	Manufacturer	Model No.	Description
1	PC	HP	HP Compaq Elite 8200 MTPC	Non-Shielded ,1.8m (R33001)
2	USB Keyboard	DELL	SK-8115	T3A002
3	USB Mouse	DELL	G0K02XYK	R41108
4	Earphone	SALAR	V18	N/A

No.	Cable	Quantity	Description
A	USB Cable	1	Shielded, 1.8m, with one ferrite core bonded
B	USB Cable	1	Shielded, 1.2m
C	Audio Cable	1	No-Shielded, 1.8m,
D	VGA Cable	1	Shielded, 1.2m&1.5m&1.8m, with two ferrite core bonded
E	HDMI Cable	1	Shielded, 1.2m&1.5m&1.8m
G	Display Cable	1	Shielded, 1.2m&1.5m&1.8m
F	Audio Cable	1	Shielded, 1.2m&1.5m&1.8m

**3.4. General Information of Test**

<input type="checkbox"/>	Test Site	Cerpass Technology Corporation Test Laboratory Address: No.10, Ln. 2, Lianfu St., Luzhu Dist., Taoyuan City 33848, Taiwan (R.O.C.) Tel:+886-3-3226-888 Fax:+886-3-3226-881 Address: No.68-1, Shihbachongsi, Shihding Township, New Taipei City 223, Taiwan, R.O.C. Tel: +886-2-2663-8582
	FCC	TW1079, TW1061,390316, 228391, 641184
	IC	4934B-1, 4934E-1, 4934E-2
	VCCI	T-2205 for Telecommunication Test C-4663 for Conducted emission test R-3428, R-4218 for Radiated emission test G-812, G-813 for radiated disturbance above 1GHz
<input checked="" type="checkbox"/>	Test Site	Cerpass Technology (Suzhou) Co.,Ltd Address: No.66,Tangzhuang Road, Suzhou Industrial Park, Jiangsu 215006, China Tel: +86-512-6917-5888 Fax: +86-512-6917-5666
	FCC	331395
	IC	7290A-1, 7290A-2
	VCCI	T-1945 for Telecommunication Test C-2919 for Conducted emission test R-2670 for Radiated emission test G-227 for radiated disturbance above 1GHz
Frequency Range Investigated:		Conducted: from 150kHz to 30 MHz Radiation: from 30 MHz to 6000MHz
Test Distance :		The test distance of radiated emission below 1GHz from antenna to EUT is 10 M. The test distance of radiated emission above 1GHz from antenna to EUT is 3 M.



3.5. Measurement Uncertainty

Where relevant, the following measurement uncertainty levels have been estimated for tests performed on the EUT as specified in CISPR 16-4-2:

Measurement	Frequency	Uncertainty
Conducted emissions(LINE)	0.09MHz-30MHz	+/- 0.6888 dB
Conducted emissions(NEUTRAL)	0.09MHz-30MHz	+/- 0.7002 dB

Measurement	Polarity	Frequency	Uncertainty
Radiated emissions (below 1GHz)	H	30MHz ~ 200MHz	+/- 4.0677dB
		200MHz ~1000MHz	+/- 3.9131dB
	V	30MHz ~ 200MHz	+/- 4.0678dB
		200MHz ~1000MHz	+/- 3.9142dB
Radiated emissions (above 1GHz)	H	1000MHz ~18000MHz	+/- 3.8904 dB
		18000MHz ~40000MHz	+/-3.9356dB
	V	1000MHz ~18000MHz	+/- 3.8896dB
		18000MHz ~40000MHz	+/- 3.8766dB

Measurement	Uncertainty
ESD—Rise time tr	6.4%
ESD—Peak current Ip	6%
ESD—Current at 30 ns	6%
ESD—Current at 60 ns	6%
ESD- Charging voltage	1%
RS above 1GHz	±2.28dB
RS under 1GHz	±3.62dB
EFT—Rise time tr	4%
EFT—Peak current Ip	4%
EFT—Current	4%
Surge—Rise time tr	4%



Surge—Peak current I_p	4%
Surge—Current	4%
CS-CND	$\pm 0.80\text{dB}$
CS-Clamp	$\pm 1.06\text{dB}$

This uncertainty represents an expanded uncertainty expressed at approximately the 95% confidence level using a coverage factor of $k=2$.

Consistent with industry standard (e.g. CISPR 22: 2008, clause 11, Measurement Uncertainty) determining compliance with the limits shall be based on the results of the compliance measurement. Consequently the measured emissions being less than the maximum allowed emission result in this being a compliant test or passing test.



4. Test of Conducted Emission

4.1. Test Limit

Conducted Emissions were measured from 150 kHz to 30 MHz with a bandwidth of 9 kHz and return leads of the EUT according to the methods defined in European Standard EN 55022. The EUT was placed on a nonmetallic stand in a shielded room 0.8 meters above the ground plane as shown in section 4.2. The interface cables and equipment positioning were varied within limits of reasonable applications to determine the position producing maximum conducted emissions.

Table 1 Conducted Emission Limits (dB μ V):

Frequency range (MHz)	Class A Equipment		Class B Equipment	
	Quasi Peak	Average	Quasi Peak	Average
0.15 to 0.50	79	66	66 to 56	56 to 46
0.50 to 5	73	60	56	46
5. to 30.	73	60	60	50

Note 1: The lower limits shall apply at the transition frequencies.
 Note 2: The limit decreases linearly with the logarithm of the frequency in the range 0.15 MHz to 0.5MHz.

Table 2 - Limits of conducted common mode (asymmetric mode) disturbance at telecommunication ports in the frequency range 0.15 MHz to 30 MHz(dB(μ V)).

Frequency range (MHz)	Class A Equipment				Class B Equipment			
	Voltage		Current		Voltage		Current	
	Quasi Peak	Avg.	Quasi Peak	Avg.	Quasi Peak	Avg.	Quasi Peak	Avg.
0.15 to 0.5	97~87	84~74	53~43	40~30	84~74	74~64	40~30	30~20
0.5 to 5	87	74	43	30	74	64	30	20
5 to 30	87	74	43	30	74	64	30	20

Note 1: The limits decrease linearly with the logarithm of the frequency in the range 0.15 to 0.5 MHz.
 Note 2 : The current and voltage disturbance limits are derived for use with an impedance stabilization network (ISN) which presents a common mode (asymmetric mode) impedance of 150 Ω to the telecommunication under test (conversion factor is 20 log₁₀ 150/1 = 44dB).



4.4. Measurement equipment

Instrument/Ancillary	Manufacturer	Model No.	Serial No.	Calibration Date	Valid Date.
Test Receiver	R&S	ESCI	100565	2015.03.29	2016.03.28
AMN	R&S	ESH2-Z5	100182	2014.09.04	2015.09.03
Two-Line V-Network	R&S	ENV216	100325	/	/
ISN	FCC	FCC-TLISN-T2-02	20379	2015.03.29	2016.03.28
ISN	FCC	FCC-TLISN-T4-02	20380	2015.03.29	2016.03.28
ISN	FCC	FCC-TLISN-T8-02	20381	2015.03.29	2016.03.28
ISN	TESEQ	ISN ST08	30175	2015.03.29	2016.03.28
Current Probe	R&S	EZ-17	100303	2015.03.29	2016.03.28
Passive Voltage Probe	R&S	ESH2-Z3	100026	2015.03.29	2016.03.28
Pulse Limiter	R&S	ESH3-Z2	100529	2015.03.29	2016.03.28
Temperature/ Humidity Meter	Zhicheng	ZC1-11	CEP-TH-004	2015.04.02	2016.04.01
EZ-EMC	Fala	Ver CT3A1	N/A	N/A	N/A



4.5. Test Data and Result

4.5.1 Conducted Emission for Power Port Test Data

Test Mode :	Mode 1: Full system (VGA mode 1920*1080@60Hz)		
AC Power :	AC 230V/50Hz	Phase :	LINE
Equipment :	LCD Monitor	Model No :	G2260VWQ6
Temperature :	24°C	Humidity :	50%
Pressure(mbar) :	1001	Date:	2015/06/14



No.	Frequency (MHz)	Factor (dB)	Reading (dBuV)	Level (dBuV)	Limit (dBuV)	Margin (dB)	Detector
1	0.1819	10.25	35.41	45.66	64.39	-18.73	QP
2	0.1819	10.25	24.98	35.23	54.39	-19.16	AVG
3	0.9660	10.31	23.63	33.94	56.00	-22.06	QP
4	0.9660	10.31	13.77	24.08	46.00	-21.92	AVG
5	0.9900	10.31	26.22	36.53	56.00	-19.47	QP
6	0.9900	10.31	14.96	25.27	46.00	-20.73	AVG
7	1.1100	10.31	24.37	34.68	56.00	-21.32	QP
8	1.1100	10.31	18.05	28.36	46.00	-17.64	AVG
9	1.9420	10.29	25.72	36.01	56.00	-19.99	QP
10	1.9420	10.29	22.21	32.50	46.00	-13.50	AVG
11	2.4940	10.30	26.89	37.19	56.00	-18.81	QP
12	2.4940	10.30	23.77	34.07	46.00	-11.93	AVG

Note: Measurement Level = Reading Level + Correct Factor



Test Mode :	Mode 1: Full system (VGA mode 1920*1080@60Hz)		
AC Power :	AC 230V/50Hz	Phase :	NEUTRAL
Equipment :	LCD Monitor	Model No :	G2260VWQ6
Temperature :	24°C	Humidity :	50%
Pressure(mbar) :	1001	Date:	2015/06/14



No.	Frequency (MHz)	Factor (dB)	Reading (dBuV)	Level (dBuV)	Limit (dBuV)	Margin (dB)	Detector
1	0.1819	10.20	38.29	48.49	64.39	-15.90	QP
2	0.1819	10.20	26.55	36.75	54.39	-17.64	AVG
3	0.9940	10.32	26.40	36.72	56.00	-19.28	QP
4	0.9940	10.32	14.08	24.40	46.00	-21.60	AVG
5	1.3099	10.40	22.90	33.30	56.00	-22.70	QP
6	1.3099	10.40	13.64	24.04	46.00	-21.96	AVG
7	1.9420	10.48	27.37	37.85	56.00	-18.15	QP
8	1.9420	10.48	25.18	35.66	46.00	-10.34	AVG
9	2.4980	10.50	25.26	35.76	56.00	-20.24	QP
10	2.4980	10.50	21.88	32.38	46.00	-13.62	AVG
11	4.0939	10.53	23.27	33.80	56.00	-22.20	QP
12	4.0939	10.53	13.98	24.51	46.00	-21.49	AVG

Note: Measurement Level = Reading Level + Correct Factor



Test Mode :	Mode 4: Full system (HDMI mode 1920*1080@60Hz)		
AC Power :	AC 230V/50Hz	Phase :	LINE
Equipment :	LCD Monitor	Model No :	G2260VWQ6
Temperature :	24°C	Humidity :	50%
Pressure(mbar) :	1001	Date:	2015/06/14

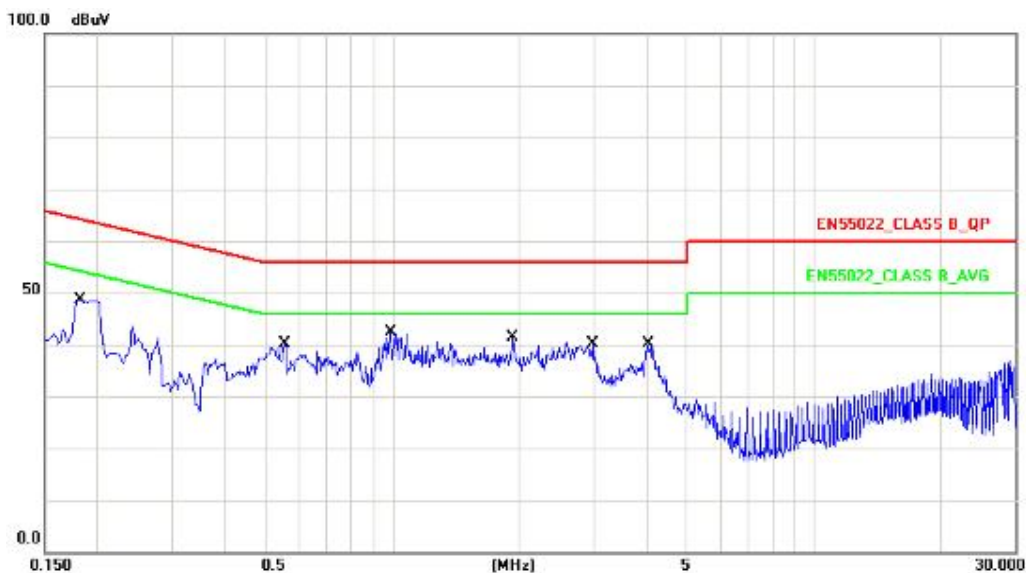

No.	Frequency (MHz)	Factor (dB)	Reading (dBuV)	Level (dBuV)	Limit (dBuV)	Margin (dB)	Detector
1	0.1835	10.25	35.70	45.95	64.32	-18.37	QP
2	0.1835	10.25	25.73	35.98	54.32	-18.34	AVG
3	0.5580	10.30	24.92	35.22	56.00	-20.78	QP
4	0.5580	10.30	15.43	25.73	46.00	-20.27	AVG
5	0.9940	10.31	26.05	36.36	56.00	-19.64	QP
6	0.9940	10.31	14.61	24.92	46.00	-21.08	AVG
7	1.9380	10.29	28.15	38.44	56.00	-17.56	QP
8	1.9380	10.29	25.48	35.77	46.00	-10.23	AVG
9	2.9820	10.30	21.82	32.12	56.00	-23.88	QP
10	2.9820	10.30	13.20	23.50	46.00	-22.50	AVG
11	4.0580	10.29	21.75	32.04	56.00	-23.96	QP
12	4.0580	10.29	11.53	21.82	46.00	-24.18	AVG

Note: Measurement Level = Reading Level + Correct Factor



Test Mode :	Mode 4: Full system (HDMI mode 1920*1080@60Hz)		
AC Power :	AC 230V/50Hz	Phase :	NEUTRAL
Equipment :	LCD Monitor	Model No :	G2260VWQ6
Temperature :	24°C	Humidity :	50%
Pressure(mbar) :	1001	Date:	2015/06/14

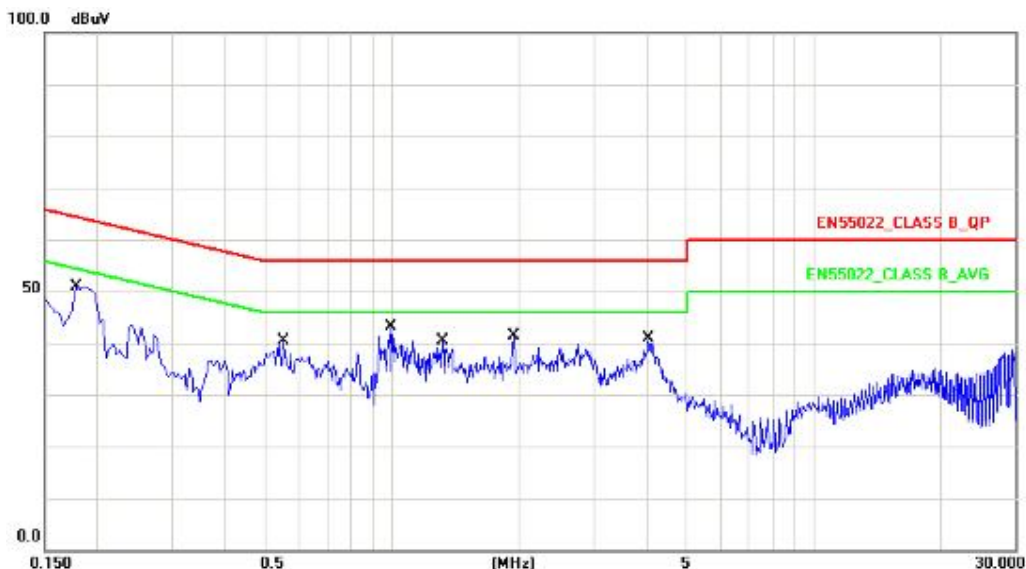

No.	Frequency (MHz)	Factor (dB)	Reading (dBuV)	Level (dBuV)	Limit (dBuV)	Margin (dB)	Detector
1	0.1780	10.20	36.74	46.94	64.57	-17.63	QP
2	0.1780	10.20	22.79	32.99	54.57	-21.58	AVG
3	0.5540	10.26	25.22	35.48	56.00	-20.52	QP
4	0.5540	10.26	19.55	29.81	46.00	-16.19	AVG
5	0.9900	10.32	26.48	36.80	56.00	-19.20	QP
6	0.9900	10.32	14.58	24.90	46.00	-21.10	AVG
7	1.3220	10.41	23.45	33.86	56.00	-22.14	QP
8	1.3220	10.41	13.20	23.61	46.00	-22.39	AVG
9	1.9420	10.48	27.55	38.03	56.00	-17.97	QP
10	1.9420	10.48	25.35	35.83	46.00	-10.17	AVG
11	4.0540	10.53	23.65	34.18	56.00	-21.82	QP
12	4.0540	10.53	13.89	24.42	46.00	-21.58	AVG

Note: Measurement Level = Reading Level + Correct Factor



Test Mode :	Mode 7: Full system (Display mode 1920*1080@75Hz)		
AC Power :	AC 230V/50Hz	Phase :	LINE
Equipment :	LCD Monitor	Model No :	G2260VWQ6
Temperature :	24°C	Humidity :	50%
Pressure(mbar) :	1001	Date:	2015/06/14

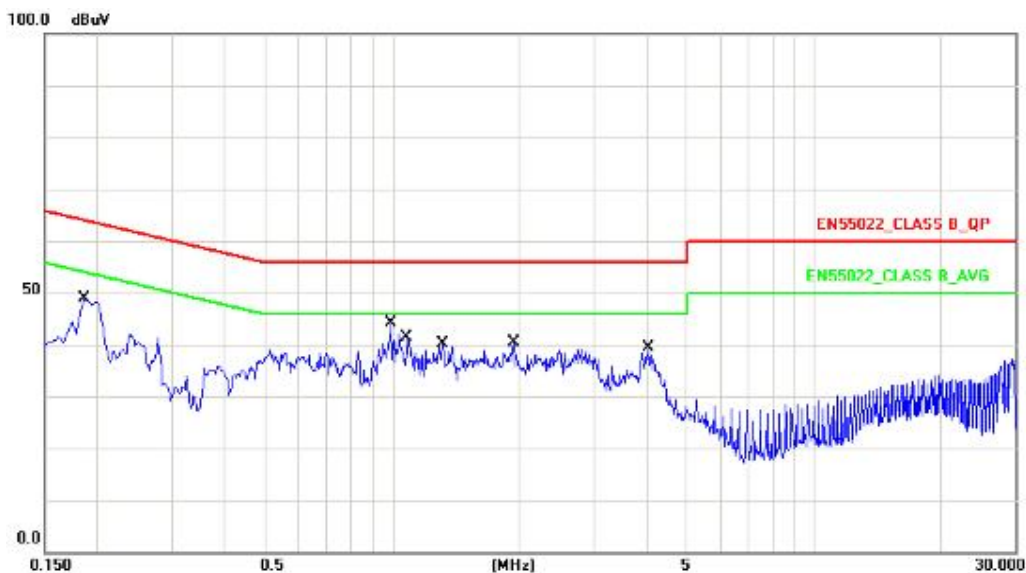

No.	Frequency (MHz)	Factor (dB)	Reading (dBuV)	Level (dBuV)	Limit (dBuV)	Margin (dB)	Detector
1	0.1860	10.25	35.76	46.01	64.21	-18.20	QP
2	0.1860	10.25	26.09	36.34	54.21	-17.87	AVG
3	0.9980	10.31	25.09	35.40	56.00	-20.60	QP
4	0.9980	10.31	13.87	24.18	46.00	-21.82	AVG
5	1.0859	10.31	23.65	33.96	56.00	-22.04	QP
6	1.0859	10.31	14.24	24.55	46.00	-21.45	AVG
7	1.3220	10.30	24.19	34.49	56.00	-21.51	QP
8	1.3220	10.30	14.42	24.72	46.00	-21.28	AVG
9	1.9420	10.29	26.61	36.90	56.00	-19.10	QP
10	1.9420	10.29	23.50	33.79	46.00	-12.21	AVG
11	4.0500	10.29	21.61	31.90	56.00	-24.10	QP
12	4.0500	10.29	11.74	22.03	46.00	-23.97	AVG

Note: Measurement Level = Reading Level + Correct Factor



Test Mode :	Mode 7: Full system (Display mode 1920*1080@75Hz)		
AC Power :	AC 230V/50Hz	Phase :	NEUTRAL
Equipment :	LCD Monitor	Model No :	G2260VWQ6
Temperature :	24°C	Humidity :	50%
Pressure(mbar) :	1001	Date:	2015/06/14



No.	Frequency (MHz)	Factor (dB)	Reading (dBuV)	Level (dBuV)	Limit (dBuV)	Margin (dB)	Detector
1	0.1819	10.20	38.05	48.25	64.39	-16.14	QP
2	0.1819	10.20	26.57	36.77	54.39	-17.62	AVG
3	0.9900	10.32	26.51	36.83	56.00	-19.17	QP
4	0.9900	10.32	14.57	24.89	46.00	-21.11	AVG
5	1.2420	10.39	22.26	32.65	56.00	-23.35	QP
6	1.2420	10.39	14.80	25.19	46.00	-20.81	AVG
7	1.9380	10.48	26.61	37.09	56.00	-18.91	QP
8	1.9380	10.48	24.17	34.65	46.00	-11.35	AVG
9	2.8900	10.51	21.79	32.30	56.00	-23.70	QP
10	2.8900	10.51	12.78	23.29	46.00	-22.71	AVG
11	4.0260	10.53	22.42	32.95	56.00	-23.05	QP
12	4.0260	10.53	12.56	23.09	46.00	-22.91	AVG

Note: Measurement Level = Reading Level + Correct Factor

Test engineer: Seben



4.5.2 Conducted Emission for Telecommunication Port Test Data

Note: The EUT doesn't have the telecommunication port.



4.6. Test Photographs of Power Port

Front View



Rear View





5. Test of Radiated Emission

5.1. Test Limit

The EUT shall meet the limits of below Table when measured at the measuring distance R in accordance with the methods described in European Standard EN 55022 Clause 10. If the reading on the measuring receiver shows fluctuations close to the limit, the reading shall be observed for at least 15 s at each measurement frequency; the highest reading shall be recorded, with the exception of any brief isolated high reading, which shall be ignored.

Table 1 – Limits for radiated disturbance at a measuring distance of 10 m (dB(μV/m))

Frequency range(MHz)	Class A Equipment		Class B Equipment	
	Quasi-peak		Quasi-peak	
30 to 230	40		30	
230 to 1000	47		37	
NOTE 1 The lower limit shall apply at the transition frequency.				
NOTE 2 Additional provisions may be required for cases where interference occurs.				

The EUT shall meet the limits of below Table when measured in accordance with the method described in European Standard EN 55022 Clause 10 and the conditional testing procedure described below.

Table 2 – Limits for radiated disturbance at a measuring distance of 3 m (dB (μV/m))

Frequency range (MHz)	Class A Equipment		Class B Equipment	
	Avg.	Peak	Avg.	Peak
1 to 3	56	76	50	70
3 to 6	60	80	54	74
NOTE The lower limit applies at the transition frequency.				

• **Conditional testing procedure:**

The highest internal source of an EUT is defined as the highest frequency generated or used within the EUT or on which the EUT operates or tunes.

If the highest frequency of the internal sources of the EUT is less than 108 MHz, the measurement shall only be made up to 1 GHz.

If the highest frequency of the internal sources of the EUT is between 108 MHz and 500 MHz, the measurement shall only be made up to 2 GHz.

If the highest frequency of the internal sources of the EUT is between 500 MHz and 1 GHz, the measurement shall only be made up to 5 GHz.

If the highest frequency of the internal sources of the EUT is above 1 GHz, the measurement shall be made up to 5 times the highest frequency or 6 GHz, whichever is less.



5.2. Test Procedures

- a. The EUT was placed on a rotatable table top 0.8 meter above ground.
- b. The EUT was set 3/10 meters from the interference receiving antenna which was mounted on the top of a variable height antenna tower.
- c. The table was rotated 360 degrees to determine the position of the highest radiation.
- d. The antenna is a half wave dipole and its height is varied between one meter and four meters above ground to find the maximum value of the field strength both horizontal polarization and vertical polarization of the antenna are set to make the measurement.
- e. For each suspected emission the EUT was arranged to its worst case and then tune the antenna tower (from 1 M to 4 M) and turn table (from 0 degree to 360 degrees) to find the maximum reading.
- f. Set the test-receiver system to Peak Detect Function and specified bandwidth with Maximum Hold Mode.
- g. If the emission level of the EUT in peak mode was 3 dB lower than the limit specified, then testing will be stopped and peak values of EUT will be reported, otherwise, the emissions which do not have 3 dB margin will be repeated one by one using the quasi-peak method and reported.

5.3. Typical test Setup

Below 1GHz Test Setup

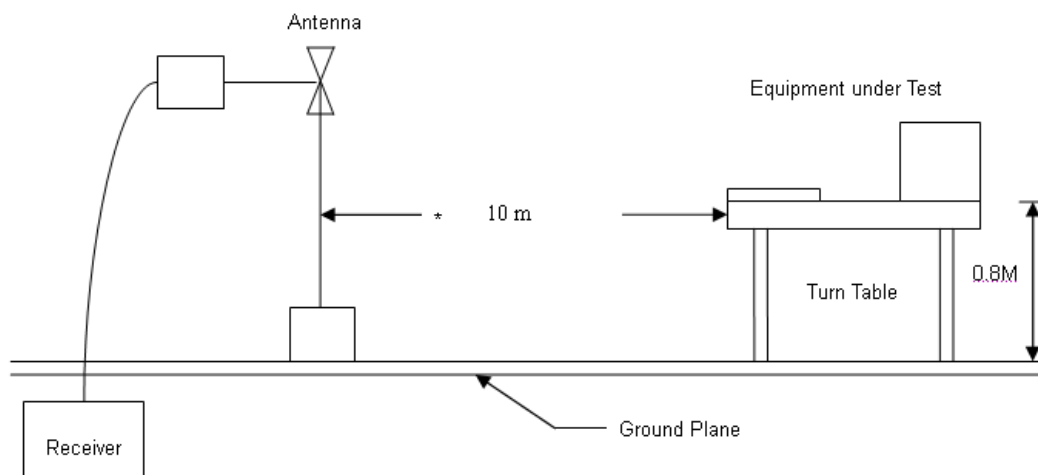

Above 1GHz Test Setup

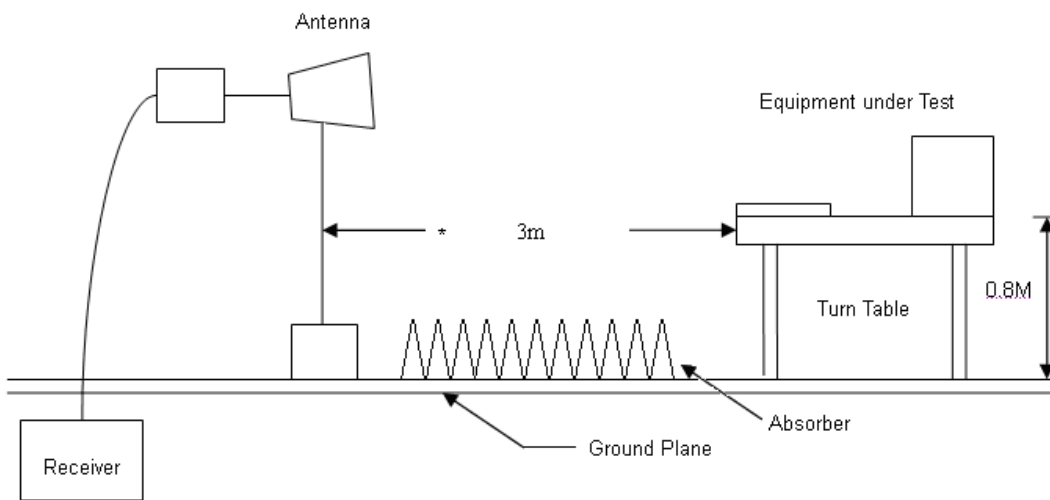

5.4. Measurement equipment

Instrument/Ancillary	Manufacturer	Model No.	Serial No.	Calibration Date	Valid Date.
EMI Test Receiver	R&S	ESCI7	100968	2015.03.29	2016.03.28
Preamplifier	Agilent	87405B	My39500554	2015.03.29	2016.03.28
Preamplifier	Agilent	8449B	3008A02342	2015.03.29	2016.03.28
Bilog Antenna	Sunol Science	JB1	A072414-3	2014.08.05	2015.08.04
Broad-Band Horn Antenna	Schwarzbeck	BBHA9120D	9120D-619	2015.04.20	2016.04.19
Spectrum Analyzer	R&S	FSP40	100324	2015.03.29	2016.03.28
Temperature/ Humidity Meter	Zhicheng	ZC1-11	CEP-TH-001	2015.04.02	2016.04.01
EZ-EMC	Fala	Ver CT3A1	N/A	N/A	N/A



5.5. Test Result and Data (30MHz ~ 1000MHz)

Test Mode :	Mode 1: Full system (VGA mode 1920*1080@60Hz)		
AC Power :	AC 230V/50Hz	Ant. Polarization:	Horizontal
Equipment :	LCD Monitor	Model No :	G2260VWQ6
Temperature :	23°C	Humidity :	48%
Pressure(mbar) :	1001	Date:	2015/06/16



No.	Frequency (MHz)	Factor (dB/m)	Reading (dBuV)	Level (dBuV/m)	Limit (dBuV/m)	Margin (dB)	Det.	Height (cm)	Azimuth (deg)
1	30.0000	-0.76	25.34	24.58	30.00	-5.42	QP	100	148
2	210.4199	-10.92	36.86	25.94	30.00	-4.06	QP	200	96
3	381.1399	-5.38	33.30	27.92	37.00	-9.08	QP	100	306
4	460.6800	-3.46	33.26	29.80	37.00	-7.20	QP	200	197
5	491.7200	-2.79	33.81	31.02	37.00	-5.98	QP	100	52
6	634.3098	0.34	28.90	29.24	37.00	-7.76	QP	100	348

Note: Measurement Level = Reading Level + Correct Factor



Test Mode :	Mode 1: Full system (VGA mode 1920*1080@60Hz)		
AC Power :	AC 230V/50Hz	Ant. Polarization:	Vertical
Equipment :	LCD Monitor	Model No :	G2260VWQ6
Temperature :	23°C	Humidity :	48%
Pressure(mbar) :	1001	Date:	2015/06/16

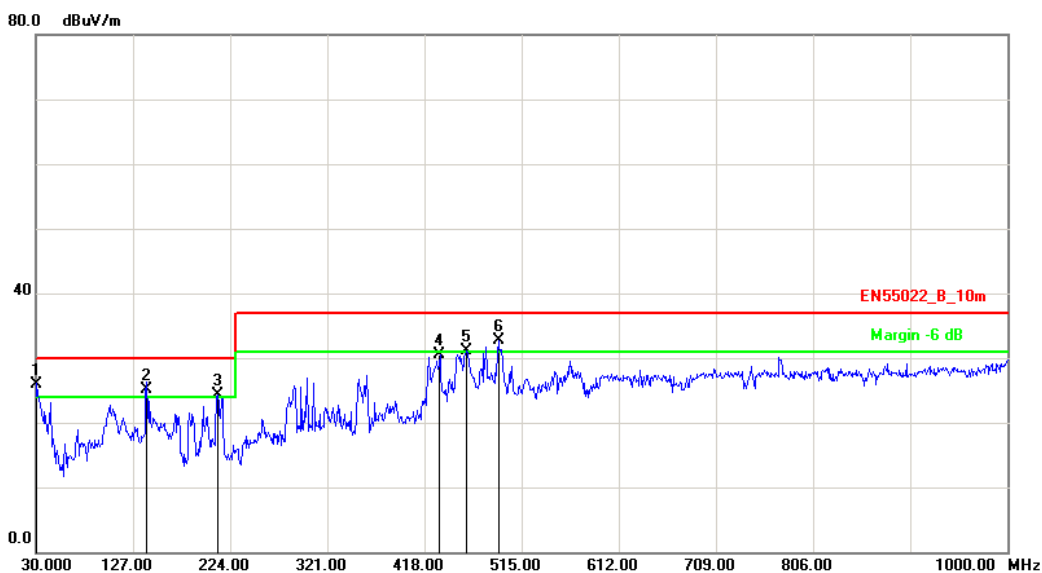

No.	Frequency (MHz)	Factor (dB/m)	Reading (dBuV)	Level (dBuV/m)	Limit (dBuV/m)	Margin (dB)	Det.	Height (cm)	Azimuth (deg)
1	30.9698	-1.20	27.14	25.94	30.00	-4.06	QP	100	148
2	140.5800	-10.43	35.52	25.09	30.00	-4.91	QP	200	320
3	211.3899	-10.91	35.14	24.23	30.00	-5.77	QP	100	98
4	433.5199	-4.05	34.47	30.42	37.00	-6.58	QP	100	209
5	459.7099	-3.48	34.58	31.10	37.00	-5.90	QP	100	144
6	491.7200	-2.79	35.54	32.75	37.00	-4.25	QP	100	52

Note: Measurement Level = Reading Level + Correct Factor



Test Mode :	Mode 4: Full system (HDMI mode 1920*1080@60Hz)		
AC Power :	AC 230V/50Hz	Ant. Polarization:	Horizontal
Equipment :	LCD Monitor	Model No :	G2260VWQ6
Temperature :	23°C	Humidity :	48%
Pressure(mbar) :	1001	Date:	2015/06/16

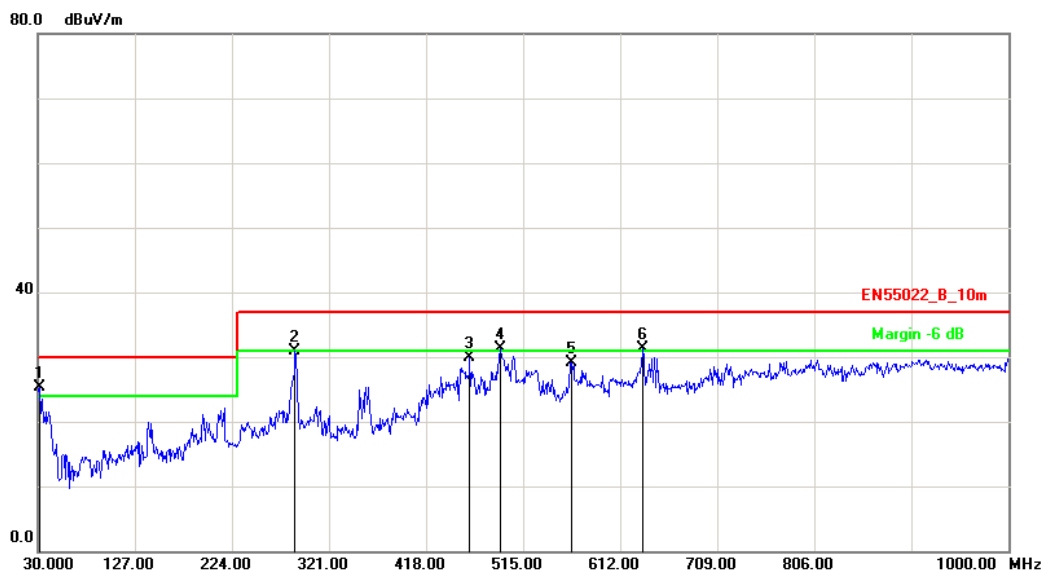

No.	Frequency (MHz)	Factor (dB/m)	Reading (dBuV)	Level (dBuV/m)	Limit (dBuV/m)	Margin (dB)	Det.	Height (cm)	Azimuth (deg)
1	31.9400	-1.64	26.94	25.30	30.00	-4.70	QP	200	55
2	287.0500	-8.65	39.55	30.90	37.00	-6.10	QP	100	145
3	461.6499	-3.44	33.35	29.91	37.00	-7.09	QP	100	144
4	492.6899	-2.77	34.04	31.27	37.00	-5.73	QP	200	89
5	563.5000	-1.06	30.19	29.13	37.00	-7.87	QP	100	57
6	634.3099	0.34	31.00	31.34	37.00	-5.66	QP	100	309

Note: Measurement Level = Reading Level + Correct Factor



Test Mode :	Mode 4: Full system (HDMI mode 1920*1080@60Hz)		
AC Power :	AC 230V/50Hz	Ant. Polarization:	Vertical
Equipment :	LCD Monitor	Model No :	G2260VWQ6
Temperature :	23°C	Humidity :	48%
Pressure(mbar) :	1001	Date:	2015/06/16



No.	Frequency (MHz)	Factor (dB/m)	Reading (dBuV)	Level (dBuV/m)	Limit (dBuV/m)	Margin (dB)	Det.	Height (cm)	Azimuth (deg)
1	140.5800	-10.43	36.40	25.97	30.00	-4.03	QP	100	148
2	215.2700	-10.87	36.32	25.45	30.00	-4.55	QP	200	99
3	281.2300	-8.96	37.54	28.58	37.00	-8.42	QP	100	38
4	352.0400	-6.31	38.76	32.45	37.00	-4.55	QP	200	309
5	504.3299	-2.50	35.19	32.69	37.00	-4.31	QP	100	166
6	632.3700	0.31	32.27	32.58	37.00	-4.42	QP	300	57

Note: Measurement Level = Reading Level + Correct Factor



Test Mode :	Mode 7: Full system (Display mode 1920*1080@75Hz)		
AC Power :	AC 230V/50Hz	Ant. Polarization:	Horizontal
Equipment :	LCD Monitor	Model No :	G2260VWQ6
Temperature :	23°C	Humidity :	48%
Pressure(mbar) :	1001	Date:	2015/06/16

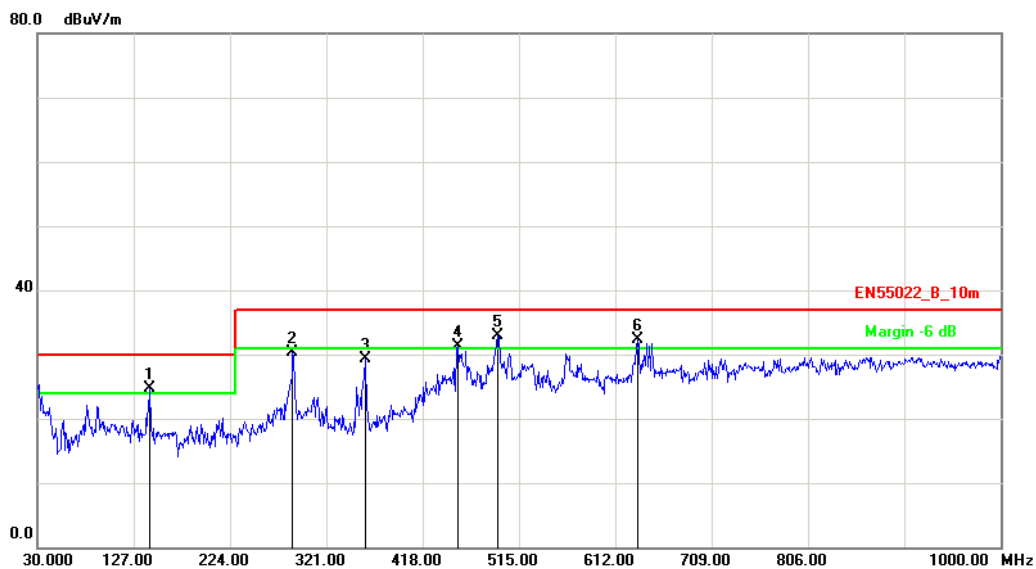

No.	Frequency (MHz)	Factor (dB/m)	Reading (dBuV)	Level (dBuV/m)	Limit (dBuV/m)	Margin (dB)	Det.	Height (cm)	Azimuth (deg)
1	143.4900	-10.48	35.23	24.75	30.00	-5.25	QP	100	348
2	287.0500	-8.65	39.05	30.40	37.00	-6.60	QP	100	66
3	359.8000	-6.06	35.35	29.29	37.00	-7.71	QP	200	59
4	453.8899	-3.61	35.00	31.39	37.00	-5.61	QP	100	302
5	493.6600	-2.75	35.61	32.86	37.00	-4.14	QP	100	148
6	634.3099	0.34	32.65	32.99	37.00	-4.01	QP	200	99

Note: Measurement Level = Reading Level + Correct Factor



Test Mode :	Mode 7: Full system (Display mode 1920*1080@75Hz)		
AC Power :	AC 230V/50Hz	Ant. Polarization:	Vertical
Equipment :	LCD Monitor	Model No :	G2260VWQ6
Temperature :	23°C	Humidity :	48%
Pressure(mbar) :	1001	Date:	2015/06/16

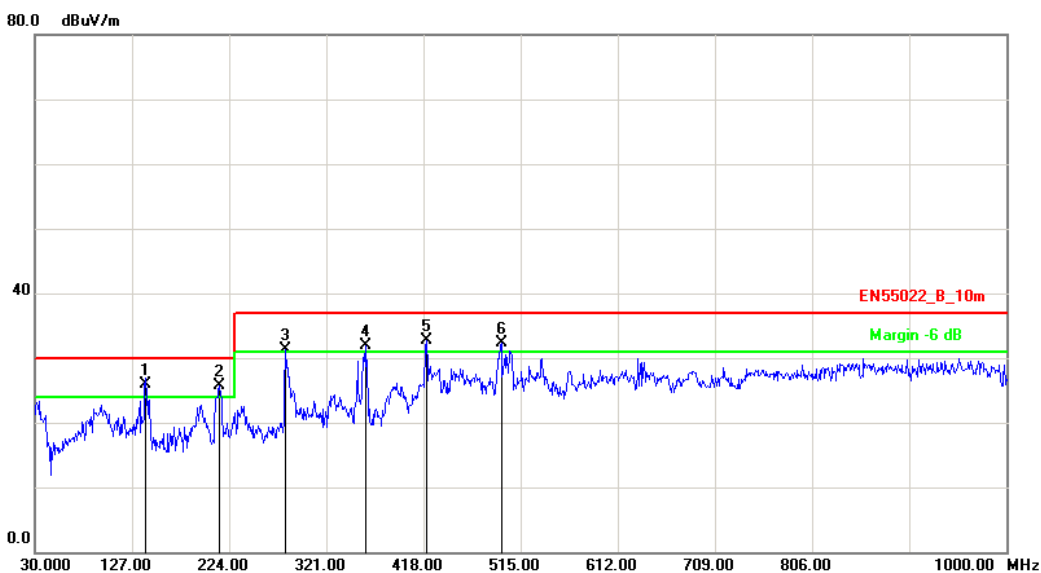

No.	Frequency (MHz)	Factor (dB/m)	Reading (dBuV)	Level (dBuV/m)	Limit (dBuV/m)	Margin (dB)	Det.	Height (cm)	Azimuth (deg)
1	140.5800	-10.43	36.26	25.83	30.00	-4.17	QP	100	158
2	214.3000	-10.88	36.62	25.74	30.00	-4.26	QP	100	302
3	280.2599	-9.02	40.26	31.24	37.00	-5.76	QP	100	47
4	359.8000	-6.06	37.97	31.91	37.00	-5.09	QP	200	230
5	420.9100	-4.33	37.10	32.77	37.00	-4.23	QP	100	222
6	495.6000	-2.71	35.07	32.36	37.00	-4.64	QP	200	209

Note: Measurement Level = Reading Level + Correct Factor



5.6. Test Result and Data (1000MHz ~ 6000MHz)

Test Mode :	Mode 1: Full system (VGA mode 1920*1080@60Hz)		
AC Power :	AC 230V/50Hz	Ant. Polarization:	Horizontal
Equipment :	LCD Monitor	Model No :	G2260VWQ6
Temperature :	23°C	Humidity :	48%
Pressure(mbar) :	1001	Date:	2015/06/16

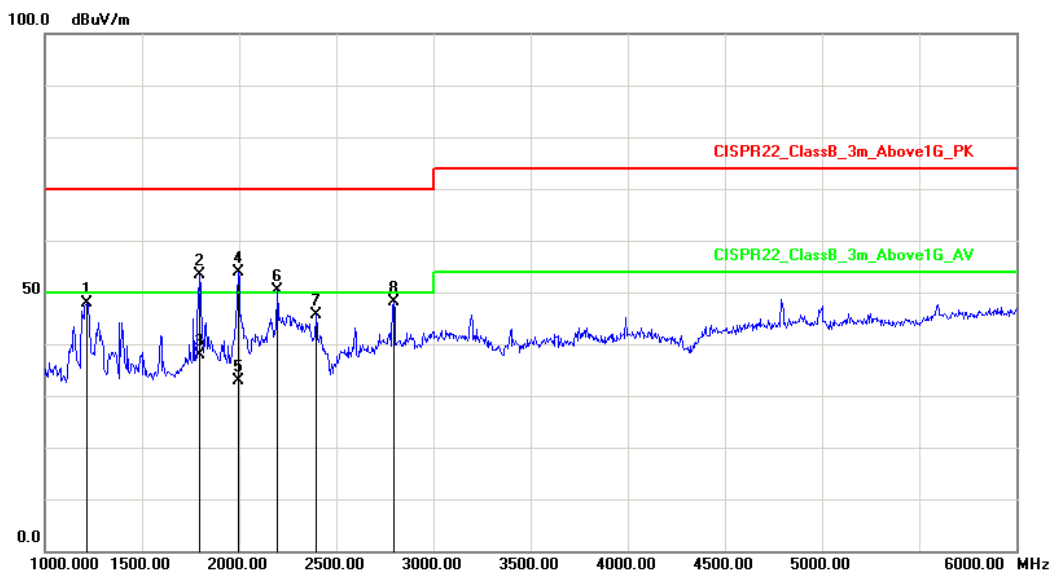

No.	Frequency (MHz)	Factor (dB/m)	Reading (dBuV)	Level (dBuV/m)	Limit (dBuV/m)	Margin (dB)	Det.	Height (cm)	Azimuth (deg)
1	1215.000	-14.34	62.16	47.82	70.00	-22.18	peak	100	359
2	1795.000	-10.64	64.12	53.48	70.00	-16.52	peak	100	25
3	1795.000	-10.64	48.53	37.89	50.00	-12.11	AVG	100	145
4	1995.000	-9.05	63.03	53.98	70.00	-16.02	peak	100	164
5	1995.000	-9.05	42.02	32.97	50.00	-17.03	AVG	100	145
6	2195.000	-5.72	55.69	49.97	70.00	-20.03	peak	100	156
7	2395.000	-3.24	48.83	45.59	70.00	-24.41	peak	100	6
8	2795.000	-4.37	52.38	48.01	70.00	-21.99	peak	100	237

Note: Measurement Level = Reading Level + Correct Factor



Test Mode :	Mode 1: Full system (VGA mode 1920*1080@60Hz)		
AC Power :	AC 230V/50Hz	Ant. Polarization:	Vertical
Equipment :	LCD Monitor	Model No :	G2260VWQ6
Temperature :	23°C	Humidity :	48%
Pressure(mbar) :	1001	Date:	2015/06/16

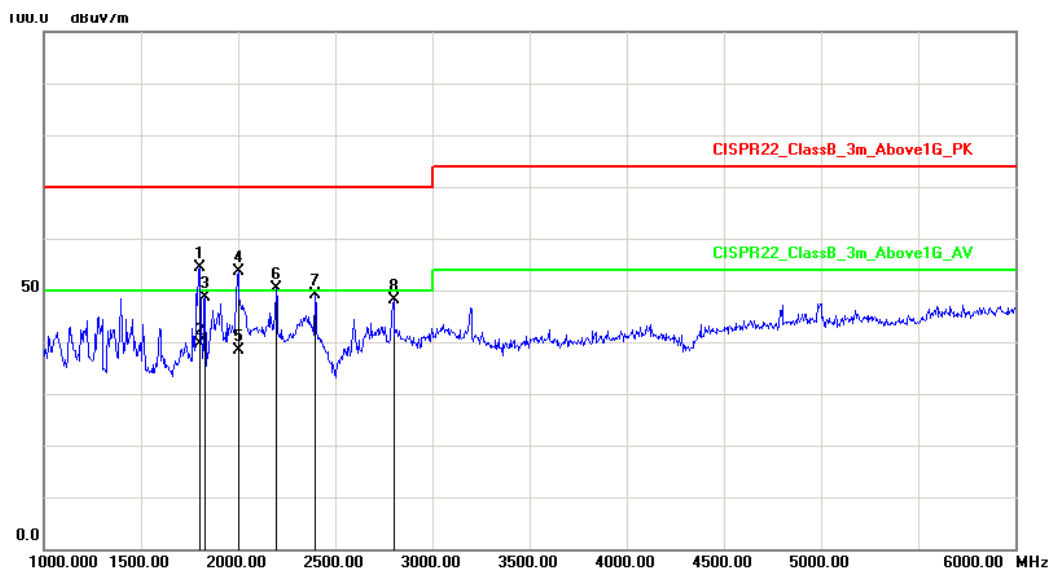

No.	Frequency (MHz)	Factor (dB/m)	Reading (dBUV)	Level (dBUV/m)	Limit (dBUV/m)	Margin (dB)	Det.	Height (cm)	Azimuth (deg)
1	1800.000	-10.59	64.88	54.29	70.00	-15.71	peak	100	138
2	1800.000	-10.59	50.23	39.64	50.00	-10.36	AVG	100	148
3	1830.000	-10.36	59.00	48.64	70.00	-21.36	peak	100	222
4	2000.000	-9.01	62.67	53.66	70.00	-16.34	peak	200	302
5	2000.000	-9.01	47.30	38.29	50.00	-11.71	AVG	100	212
6	2195.000	-5.72	55.67	49.95	70.00	-20.05	peak	100	213
7	2395.000	-3.24	52.38	49.14	70.00	-20.86	peak	100	153
8	2800.000	-4.35	52.48	48.13	70.00	-21.87	peak	100	94

Note: Measurement Level = Reading Level + Correct Factor



Test Mode :	Mode 4: Full system (HDMI mode 1920*1080@60Hz)		
AC Power :	AC 230V/50Hz	Ant. Polarization:	Horizontal
Equipment :	LCD Monitor	Model No :	G2260VWQ6
Temperature :	23°C	Humidity :	48%
Pressure(mbar) :	1001	Date:	2015/06/16

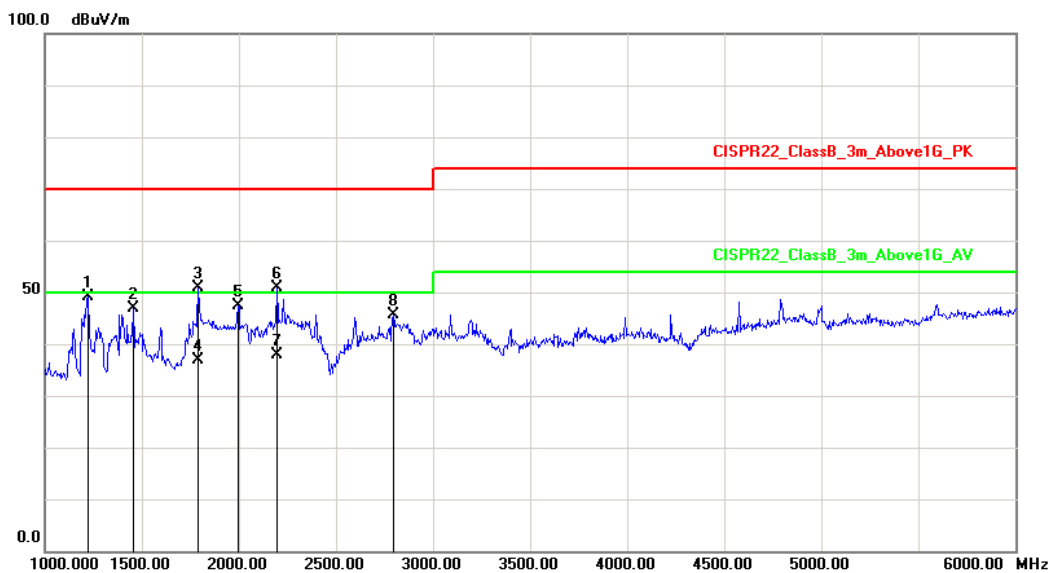

No.	Frequency (MHz)	Factor (dB/m)	Reading (dBuV)	Level (dBuV/m)	Limit (dBuV/m)	Margin (dB)	Det.	Height (cm)	Azimuth (deg)
1	1225.000	-14.23	63.25	49.02	70.00	-20.98	peak	100	78
2	1455.000	-12.50	59.41	46.91	70.00	-23.09	peak	100	148
3	1790.000	-10.68	61.46	50.78	70.00	-19.22	peak	100	321
4	1790.000	-10.68	47.62	36.94	50.00	-13.06	AVG	100	359
5	1995.000	-9.05	56.53	47.48	70.00	-22.52	peak	100	22
6	2195.000	-5.72	55.59	49.87	70.00	-20.13	peak	100	345
7	2195.000	-5.72	43.61	37.89	50.00	-12.11	AVG	100	0
8	2795.000	-4.37	49.88	45.51	70.00	-24.49	peak	100	94

Note: Measurement Level = Reading Level + Correct Factor



Test Mode :	Mode 4: Full system (HDMI mode 1920*1080@60Hz)		
AC Power :	AC 230V/50Hz	Ant. Polarization:	Vertical
Equipment :	LCD Monitor	Model No :	G2260VWQ6
Temperature :	23°C	Humidity :	48%
Pressure(mbar) :	1001	Date:	2015/06/16

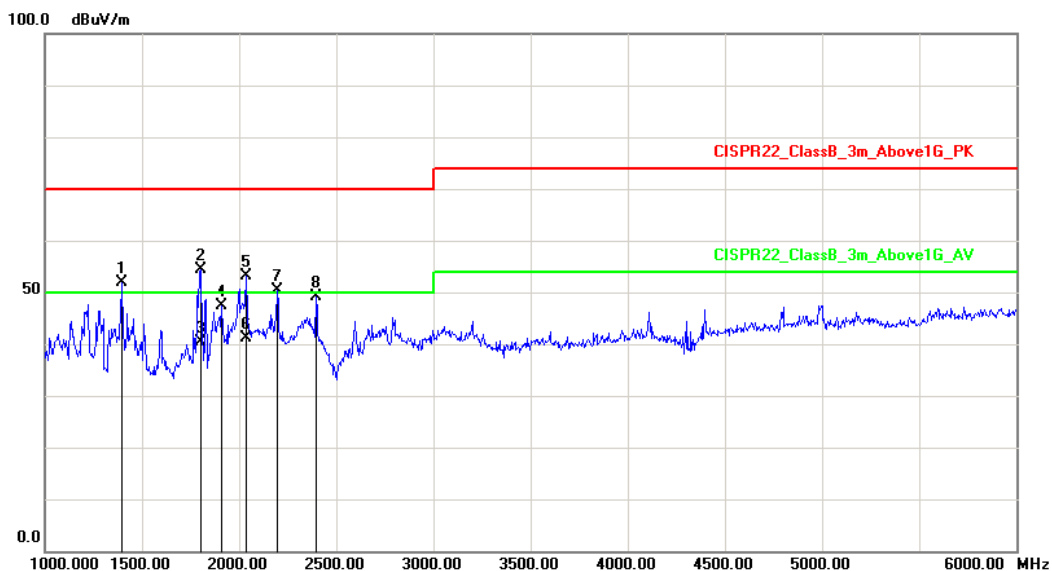

No.	Frequency (MHz)	Factor (dB/m)	Reading (dBuV)	Level (dBuV/m)	Limit (dBuV/m)	Margin (dB)	Det.	Height (cm)	Azimuth (deg)
1	1395.000	-12.69	64.68	51.99	70.00	-18.01	peak	100	148
2	1800.000	-10.59	64.88	54.29	70.00	-15.71	peak	100	98
3	1800.000	-10.59	50.88	40.29	50.00	-9.71	AVG	100	210
4	1910.000	-9.75	57.07	47.32	70.00	-22.68	peak	100	111
5	2035.000	-8.25	61.30	53.05	70.00	-16.95	peak	100	231
6	2035.000	-8.25	49.46	41.21	50.00	-8.79	AVG	100	58
7	2195.000	-5.72	55.67	49.95	70.00	-20.05	peak	100	309
8	2395.000	-3.24	52.38	49.14	70.00	-20.86	peak	100	222

Note: Measurement Level = Reading Level + Correct Factor



Test Mode :	Mode 7: Full system (Display mode 1920*1080@75Hz)		
AC Power :	AC 230V/50Hz	Ant. Polarization:	Horizontal
Equipment :	LCD Monitor	Model No :	G2260VWQ6
Temperature :	23°C	Humidity :	48%
Pressure(mbar) :	1001	Date:	2015/06/16

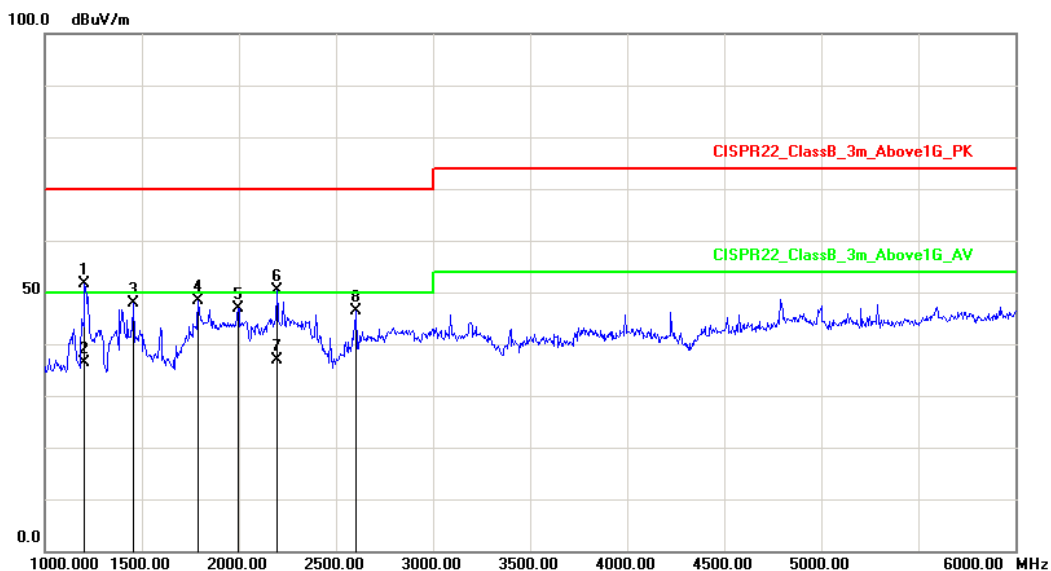

No.	Frequency (MHz)	Factor (dB/m)	Reading (dBuV)	Level (dBuV/m)	Limit (dBuV/m)	Margin (dB)	Det.	Height (cm)	Azimuth (deg)
1	1205.000	-14.46	66.01	51.55	70.00	-18.45	peak	100	148
2	1205.000	-14.46	50.94	36.48	50.00	-13.52	AVG	100	321
3	1455.000	-12.50	60.41	47.91	70.00	-22.09	peak	100	245
4	1790.000	-10.68	58.96	48.28	70.00	-21.72	peak	100	55
5	1995.000	-9.05	56.03	46.98	70.00	-23.02	peak	100	324
6	2195.000	-5.72	56.09	50.37	70.00	-19.63	peak	100	20
7	2195.000	-5.72	42.61	36.89	50.00	-13.11	AVG	100	6
8	2605.000	-4.51	50.78	46.27	70.00	-23.73	peak	100	67

Note: Measurement Level = Reading Level + Correct Factor



Test Mode :	Mode 7: Full system (Display mode 1920*1080@75Hz)		
AC Power :	AC 230V/50Hz	Ant. Polarization:	Vertical
Equipment :	LCD Monitor	Model No :	G2260VWQ6
Temperature :	23°C	Humidity :	48%
Pressure(mbar) :	1001	Date:	2015/06/16

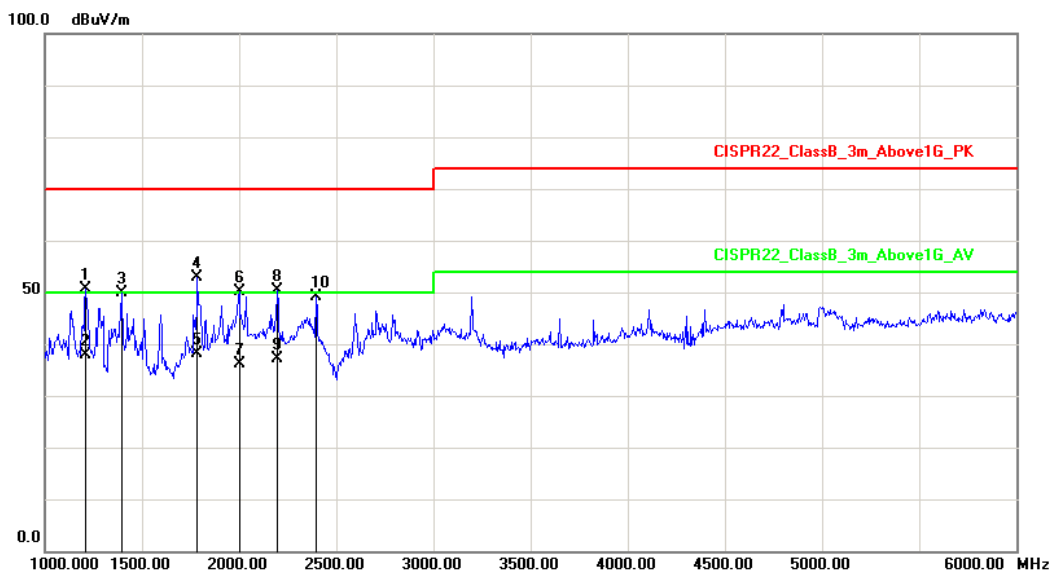

No.	Frequency (MHz)	Factor (dB/m)	Reading (dBuV)	Level (dBuV/m)	Limit (dBuV/m)	Margin (dB)	Det.	Height (cm)	Azimuth (deg)
1	1210.000	-14.40	65.09	50.69	70.00	-19.31	peak	100	148
2	1210.000	-14.40	52.29	37.89	50.00	-12.11	AVG	100	248
3	1395.000	-12.69	62.68	49.99	70.00	-20.01	peak	100	360
4	1785.000	-10.73	63.55	52.82	70.00	-17.18	peak	100	98
5	1785.000	-10.73	48.79	38.06	50.00	-11.94	AVG	100	24
6	2000.000	-9.01	59.17	50.16	70.00	-19.84	peak	100	206
7	2000.000	-9.01	45.20	36.19	50.00	-13.81	AVG	100	154
8	2195.000	-5.72	56.07	50.35	70.00	-19.65	peak	100	301
9	2195.000	-5.72	42.73	37.01	50.00	-12.99	AVG	100	215
10	2395.000	-3.24	52.38	49.14	70.00	-20.86	peak	100	78

Note: Measurement Level = Reading Level + Correct Factor

Test engineer: Seben



5.7. Test Photographs (30MHz ~ 1000MHz)

Front View



Rear View

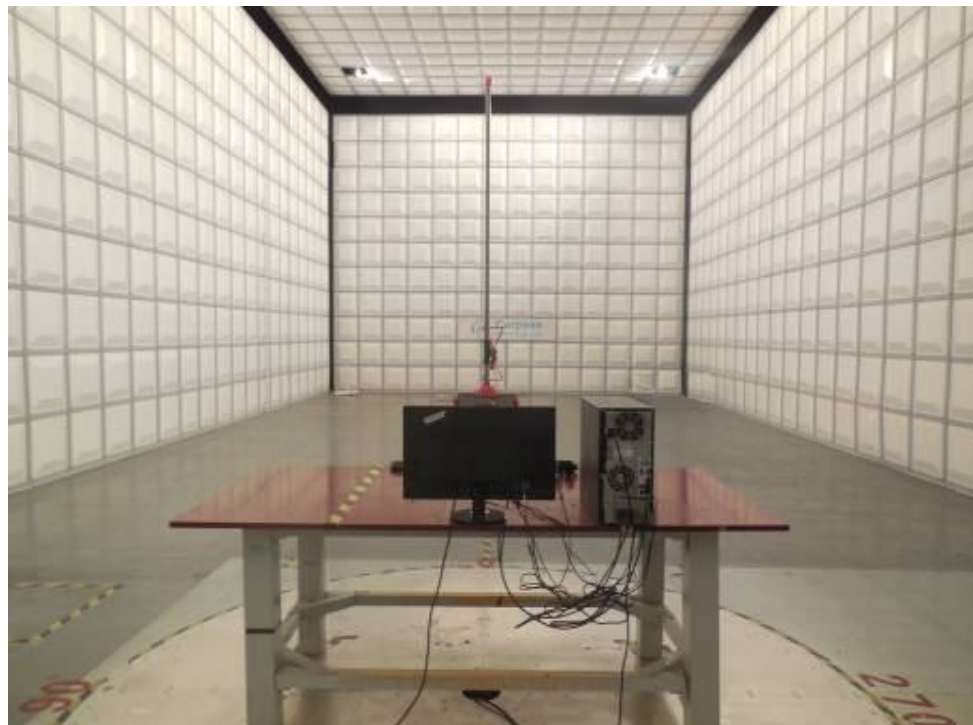



5.8. Test Photographs (1000MHz ~ 6000MHz)

Front View



Rear View

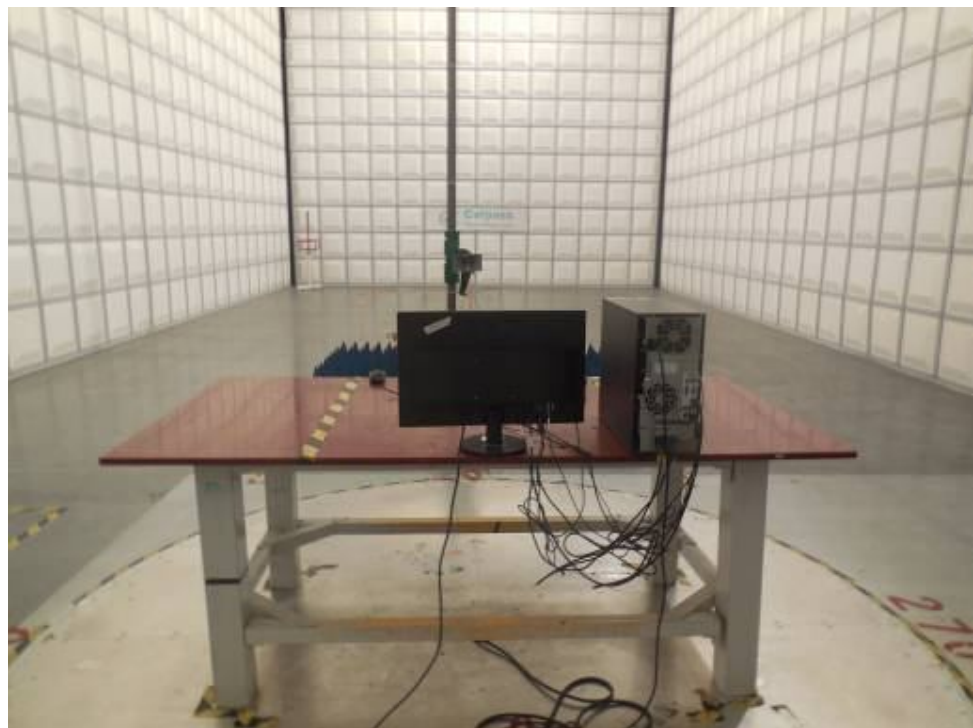



6. Harmonics Test

6.1. Limits of Harmonics Current Measurement

Limits for Class A equipment

Harmonics Order n	Max. permissible harmonics current A	Harmonics Order n	Max. permissible harmonics current A
Odd harmonics		Even harmonics	
3	2.30	2	1.08
5	1.14	4	0.43
7	0.77	6	0.30
9	0.40	8<=n<=40	0.23x8/n
11	0.33		
13	0.21		
15<=n<=39	0.15x15/n		

(b) Limits for Class B equipment

For Class B equipment, the harmonics of the input current shall not exceed the values given in Table that is the limit of Class A multiplied by a factor of 1,5.

(c) Limits for Class C equipment

Harmonics Order n	Maximum permissible harmonic current expressed as a percentage of the input current at the fundamental frequency %
2	2
3	$30 \cdot \lambda^*$
5	10
7	7
9	5
11<n<39 (odd harmonics only)	3

* λ is the circuit power factor

(d) Limits for Class D equipment

Harmonics Order n	Maximum permissible harmonic current per watt mA/W	Maximum permissible harmonic current A
3	3.4	2.30
5	1.9	1.14
7	1.0	0.77
9	0.5	0.40
11	0.35	0.33
11 < n < 39 (odd harmonics only)	3.85/n	See limit of Class A

NOTE: According to section 7 of EN 61000-3-2, the above limits for all equipment except for lighting



equipment having an active input power > 75 W and no limits apply for equipment with an active input power up to and including 75 W.

6.2. Measurement equipment

Instrument/Ancillary	Manufacturer	Model No.	Serial No.	Calibration Date	Valid Date.
EMC Emission Tester	EMCPARTNER	Harmonics-1000	159	2015.04.02	2016.04.01
Temperature/ Humidity Meter	Zhicheng	ZC1-11	CEP-TH-004	2015.04.02	2016.04.01
POWER SOURCE	Pacific	140AMX-UP12/S	1792	2014.09.04	2015.09.03
HARCS	EMC Partner AG	Ver 4.18	N/A	N/A	N/A



6.3. Test Result and Data

Basic Standard	:	EN 61000-3-2
Final Test Result	:	PASS
Test Mode	:	Mode 1, Mode 4, Mode 7
Model No.	:	G2260VWQ6
Temperature	:	20°C
Humidity	:	50 %
Atmospheric Pressure	:	100 kPa
Test Date	:	Jun 15, 2015

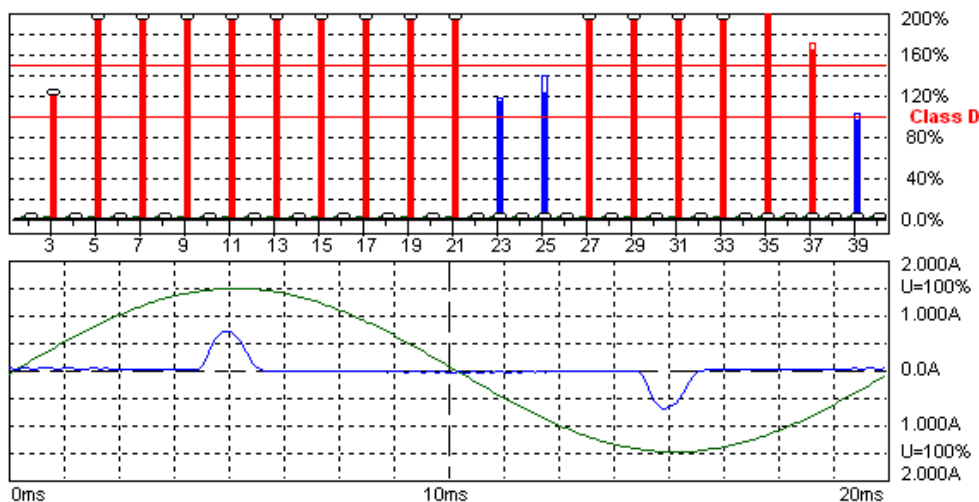

Harmonic Emission - IEC 61000-3-2, EN 61000-3-2, (EN60555-2)

2015-6-15 15:36:22 harmonic.hsu

Urms = 229.7 V	P = 19.00 W	THC = 0.162 A	Range: 2 A
Irms = 0.180 A	pf = 0.460	Pmax = 19.04 W	V-nom: 230 V
			TestTime: 15 min (100%)

HAR-1000 EMC-Partner

Full Bar : Actual Values

Empty Bar : Maximum Values

Blue : Current , Green : Voltage , Red : Failed

Urms = 229.7V Freq = 50.000 Range: 2 A
 Irms = 0.180A lpk = 0.715A cf = 3.978
 P = 19.00W S = 41.28VA pf = 0.460
 THDi = 88.2 % THDu = 0.20 % Class D
 Test - Time : 15min (100 %)
 Limit Reference: Pmax = 19.045W

Test completed



Order	Freq. [Hz]	Irms [A]	Irms%L [%]	I _{max} [A]	I _{max} %L [%]	Limit [A]	Status
1	50	0.0867		0.0870			
2	100	0.0006		0.0007			
3	150	0.0781	120.65	0.0784	121.03	0.00	N/L
4	200	0.0006		0.0007			
5	250	0.0740	204.43	0.0741	204.77	0.00	N/L
6	300	0.0006		0.0009			
7	350	0.0681	357.66	0.0682	358.30	0.00	N/L
8	400	0.0006		0.0009			
9	450	0.0602	631.99	0.0603	633.27	0.00	N/L
10	500	0.0006		0.0010			
11	550	0.0511	767.33	0.0513	769.16	0.00	N/L
12	600	0.0005		0.0009			
13	650	0.0417	740.19	0.0417	740.19	0.00	N/L
14	700	0.0005		0.0007			
15	750	0.0322	659.28	0.0322	659.28	0.00	N/L
16	800	0.0004		0.0006			
17	850	0.0231	534.91	0.0232	537.74	0.00	N/L
18	900	0.0004		0.0005			
19	950	0.0150	389.07	0.0151	392.24	0.00	N/L
20	1000	0.0002		0.0004			
21	1050	0.0083	237.74	0.0084	241.24	0.00	N/L
22	1100	0.0002		0.0004			
23	1150	0.0035	111.05	0.0037	114.87	0.00	N/L
24	1200	0.0002		0.0004			
25	1250	0.0035	120.70	0.0040	137.35	0.00	N/L
26	1300	0.0002		0.0004			
27	1350	0.0054	197.78	0.0057	211.27	0.00	N/L
28	1400	0.0002		0.0004			
29	1450	0.0065	255.89	0.0067	265.54	0.00	N/L
30	1500	0.0004		0.0004			
31	1550	0.0065	273.53	0.0066	278.69	0.00	N/L
32	1600	0.0004		0.0004			
33	1650	0.0059	263.71	0.0060	269.21	0.00	N/L
34	1700	0.0004		0.0005			
35	1750	0.0048	227.25	0.0049	233.08	0.00	N/L
36	1800	0.0004		0.0005			
37	1850	0.0032	160.16	0.0033	166.32	0.00	N/L
38	1900	0.0004		0.0005			
39	1950	0.0017	90.900	0.0018	97.393	0.00	N/L
40	2000	0.0004		0.0005			

The power of EUT is less than 75W after the testing. According the standard, the equipment with a rated power of 75W or less, other than lighting equipment, limits are not specified in this standard. So the test data needn't list.

Test engineer: 



6.4. Test Photographs





7. Voltage Fluctuations Test

7.1. Test Procedure

The equipment shall be tested under the conditions of **Clause 5**.

The total impedance of the test circuit, excluding the appliance under test, but including the internal impedance of the supply source, shall be equal to the reference impedance.

The stability and tolerance of the reference impedance shall be adequate to ensure that the overall accuracy of $\pm 8\%$ is achieved during the whole assessment procedure.

7.2. Measurement equipment

Instrument/Ancillary	Manufacturer	Model No.	Serial No.	Calibration Date	Valid Date.
EMC Emission Tester	EMCPARTNER	Harmonics-1000	159	2015.04.02	2016.04.01
Temperature/ Humidity Meter	Zhicheng	ZC1-11	CEP-TH-004	2015.04.02	2016.04.01
POWER SOURCE	Pacific	140AMX-UP12/S	1792	2014.09.04	2015.09.03
HARCS	EMC Partner AG	Ver 4.18	N/A	N/A	N/A



7.3. Test Result and Data

Basic Standard	:	EN 61000-3-3
Final Test Result	:	PASS
Test Mode	:	Mode 1, Mode 4, Mode 7
Model No.	:	G2260VWQ6
Temperature	:	20°C
Humidity	:	50 %
Atmospheric Pressure	:	100 kPa
Test Data	:	Jun 15, 2015

Flickermeter 1000-4-15 for 230V/50Hz

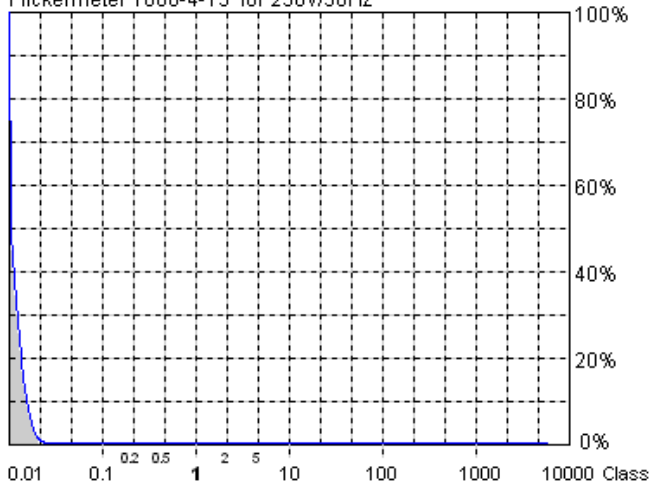

Actual Flicker (Fli): 0.01
Short-term Flicker (Pst): 0.09
 Limit (Pst): 1.00
Long-term Flicker (Ptt): 0.09
 Limit (Ptt): 0.65
Maximum Relative Volt. Change (dmax): 0.00%
 Limit (dmax): 4.00%
Relative Steady-state Voltage Change (dc): 0.08%
 Limit (dc): 3.30%
Maximum Interval exceeding 3.30% (dt): 0.00ms
 Limit (dt>Lim): 500ms

Flicker Emission - IEC 61000-3-3 , EN 61000-3-3 , (EN60555-3)

Urms = 229.7 V P = 19.09 W
 Irms = 0.179 A pf = 0.465

2015-6-15 15:14:01 harmonic.hsu

Range: 2 A
 V-nom: 230 V
 TestTime: 10 min (100%)

Test completed, Result: PASSED

HAR-1000 EMC-Parber

- Full Bar : Actual Values
- Empty Bar : Maximum Values
- Circles : Average Values
- Blue : Current , Green : Voltage , Red : Failed



Urms = 229.7V Freq = 50.013 Range: 2 A
Irms = 0.179A Ipk = 0.702A cf = 3.929
P = 19.09W S = 41.05VA pf = 0.465

Test - Time : 1 x 10min = 10min (100 %)

LIN (Line Impedance Network) : No LIN

Limits : Plt : 0.65 Pst : 1.00
dmax : 4.00 % dc : 3.30 %
dtLim: 3.30 % dt>Lim: 500ms

Test completed, Result: PASSED

Test engineer: Seben



7.4. Test Photographs





8. Electrostatic Discharge Immunity Test

8.1. Test Procedure

- a. In the case of air discharge testing the climatic conditions shall be within the following ranges:
 - ambient temperature: 15°C to 35°C;
 - relative humidity : 30% to 60%;
 - atmospheric pressure : 86 KPa (860 mbar) to 106 KPa (1060 mbar).
- b. Test programs and software shall be chosen so as to exercise all normal modes of operation of the EUT. The use of special exercising software is encouraged, but permitted only where it can be shown that the EUT is being comprehensively exercised.
- c. The test voltage shall be increased from the minimum to the selected test severity level, in order to determine any threshold of failure. The final severity level should not exceed the product specification value in order to avoid damage to the equipment.
- d. The test shall be performed with both air discharge and contact discharge. On reselected points at least 10 single discharges (in the most sensitive polarity) shall be applied on air discharge. On reselected points at least 25 single discharges (in the most sensitive polarity) shall be applied on contact discharge.
- e. For the time interval between successive single discharges an initial value of one second is recommended. Longer intervals may be necessary to determine whether a system failure has occurred.
- f. In the case of contact discharges, the tip of the discharge electrode shall touch the EUT before the discharge switch is operated.
- g. In the case of painted surface covering a conducting substrate, the following procedure shall be adopted :
 - If the coating is not declared to be an insulating coating by the equipment manufacturer, then the pointed tip of the generator shall penetrate the coating so as to make contact with the conducting substrate.
 - Coating declared as insulating by the manufacturer shall only be submitted to the air discharge.
 - The contact discharge test shall not be applied to such surfaces.
- h. In the case of air discharges, the round discharge tip of the discharge electrode shall be approached as fast as possible (without causing mechanical damage) to touch the EUT . After each discharge, the ESD generator (discharge electrode) shall be removed from the EUT. The generator is then retriggered for a new single discharge. This procedure shall be repeated until the discharges are completed. In the case of an air discharge test, the discharge switch, which is used for contact discharge, shall be closed.

8.2. Test Setup for Tests Performed in Laboratory

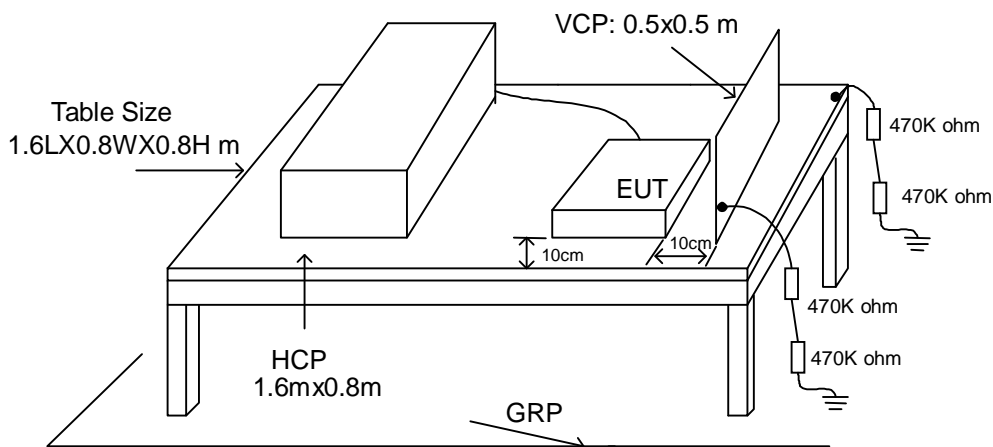

The test setup consists of the test generator, EUT and auxiliary instrumentation necessary to perform DIRECT and INDIRECT application of discharges to the EUT as applicable, in the follow manner :

- a. Contact Discharge to the conductive surfaces and to coupling plane;
- b. Air Discharge at insulating surfaces.

The preferred test method is that of type tests performed in laboratories and the only accepted method of demonstrating conformance with this standard. The EUT was arranged as closely as possible to arrangement in final installed conditions.

A ground reference plane was provided on the floor of the test site. It was a metallic sheet (copper or aluminum) of 0.25 mm, minimum thickness; other metallic may be used but they shall have at least 0.65 mm thickness. In the CerpPASS Technology Corp., we provided 1 mm thickness stainless steel ground reference plane. The minimum size of the ground reference plane is 2.5 m x 2.5 m, the exact size depending on the dimensions of the EUT. It was connected to the protective grounding system.

The EUT was arranged and connected according to its functional requirements. A distance of 1m minimum was provided between the EUT and the wall of the lab. and any other metallic structure. In cases where this length exceeds the length necessary to apply the discharges to the selected points, the excess length shall, where possible, be placed non-inductively off the ground reference plane and shall not come closer than 0.2m to other conductive parts in the test setup.

Where the EUT is installed on a metal table, the table was connected to the reference plane via a cable with a 470k ohm resistor located at each end, to prevent a build-up of charge. The test setup was consist a wooden table, 0.8m high, standing on the ground reference plane. A HCP, 1.6 m x 0.8 m, was placed on the table. The EUT and cables was isolated from the HCP by an insulating support 0.5 mm thick. The VCP size, 0.5 m x 0.5 m.



8.3. Test Severity Levels

Contact Discharge		Air Discharge	
Level	Test Voltage (KV) of Contact discharge	Level	Test Voltage (KV) of Air Discharge
1	±2	1	±2
2	±4	2	±4
3	±6	3	±8
4	±8	4	±15
X	Specified	X	Specified

Remark: "X" is an open level.

8.4. Measurement equipment

Instrument/Ancillary	Manufacturer	Model No.	Serial No.	Calibration Date	Valid Date.
ESD Simulator	EM Test	dito	V0714102399	2015.03.29	2016.03.28
Tonometer	shanghaifengyun	DYM3	3251	2014.12.01	2015.11.30
Dehumidifier	ZEDO	ZD-220LB	CEP-TH-01	N/A	N/A
Humidifier	YADU	YZ-DS251C	CEP-TH-02	N/A	N/A
Temperature/ Humidity Meter	feiyang	N/A	102	2015.04.02	2016.04.01



8.5. Test Result and Data

Basic Standard : IEC 61000-4-2
 Final Test Result : PASS
 Model No. : G2260VWQ6
 Pass performance criteria : B
 Test Voltage : ±2 / ±4 / ±8 kV for air discharge,
 : ±2 / ±4 kV for contact discharge
 Temperature : 20°C
 Relative Humidity : 50 %
 Atmospheric Pressure : 100 kPa
 Test Date : Jun 15, 2015

Test Mode 1& Mode 4& Mode 7

	Contact Discharge								Air Discharge							
	25 times / each								10 times / each							
Voltage	2 kV		4 kV		6 kV		8 kV		2 kV		4 kV		8 kV		10 kV	
Point\Polarity	+	-	+	-	+	-	+	-	+	-	+	-	+	-	+	-
HCP	A	A	A	A	---	---	---	---	---	---	---	---	---	---	---	---
VCP	A	A	A	A	---	---	---	---	---	---	---	---	---	---	---	---
Screw	A	A	A	A	---	---	---	---	---	---	---	---	---	---	---	---
Case	---	---	---	---	---	---	---	---	A	A	A	A	A	A	---	---
Panel	---	---	---	---	---	---	---	---	A	A	A	A	A	A	---	---
VGA Port	A	A	A	A	---	---	---	---	A	A	A	A	A	A	---	---
HDMI Port	A	A	A	A	---	---	---	---	A	A	A	A	A	A	---	---
Display Port	A	A	A	A	---	---	---	---	A	A	A	A	A	A	---	---
Audio in Port	---	---	---	---	---	---	---	---	A	A	A	A	A	A	---	---
Audio out Port	---	---	---	---	---	---	---	---	A	A	A	A	A	A	---	---
Power Port	---	---	---	---	---	---	---	---	A	A	A	A	A	A	---	---
Button	---	---	---	---	---	---	---	---	A	A	A	A	A	A	---	---
LED Light	---	---	---	---	---	---	---	---	A	A	A	A	A	A	---	---

Test engineer: Seben



8.6. Test Photographs





9. Radio Frequency electromagnetic field immunity test

9.1. Test Procedure

- a. The equipment to be tested is placed in the center of the enclosure on a wooden table. The equipment is then connected to power and signal leads according to pertinent installation instructions.
- b. The antenna which is enabling the complete frequency range of 80-1000 MHz is placed 3m away from the equipment. The required field strength is determined by placing the field strength meter(s) on top of or directly alongside the equipment under test and monitoring the field strength meter via a remote field strength indicator outside the enclosure while adjusting the continuous-wave to the applicable antennae.
- c. The test is normally performed with the antenna facing the most sensitive side of the EUT. The polarization of the field generated by the bucolical antenna necessitates testing each position twice, once with the antenna positioned vertically and again with the antenna positioned horizontally. The circular polarization of the field from the log-spiral antenna makes a change of position of the antenna unnecessary.
- d. At each of the above conditions, the frequency range is swept 80-1000 MHz, pausing to adjust the R.F. signal level or to switch oscillators and antenna. The rate of sweep is in the order of $1.5 \cdot 10^{-3}$ decades/s. The sensitive frequencies or frequencies of dominant interest may be discretely analyzed.

9.2. Test Severity Levels

Frequency Band : 80-1000 MHz	
Level	Test field strength (V/m)
1	1
2	3
3	10
X	Specified
Remark: "X" is an open class.	

9.3. TEST SETUP

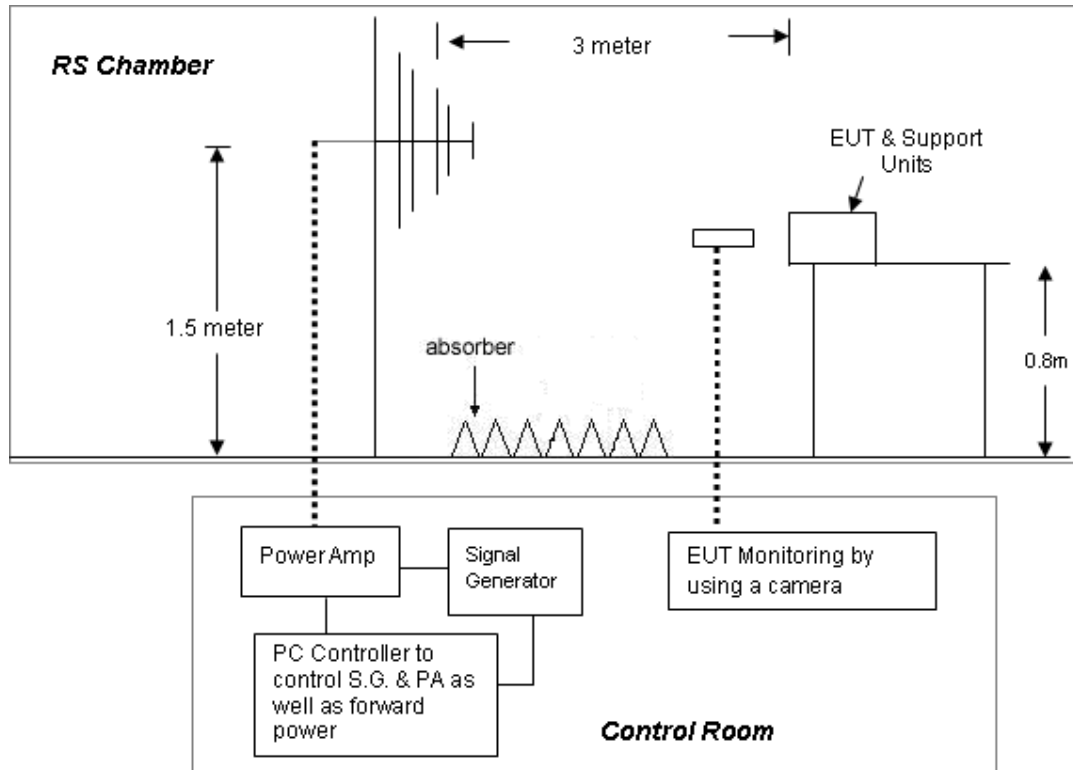

- For the actual test configuration, please refer to the related item – Photographs of the Test Configuration.

NOTE:

TABLETOP EQUIPMENT

The EUT installed in a representative system as described in section 7 of IEC 61000-4-3 was placed on a non-conductive table 0.8 meters in height. The system under test was connected to the power and signal wire according to relevant installation instructions.

FLOOR STANDING EQUIPMENT

The EUT installed in a representative system as described in section 7 of IEC 61000-4-3 was placed on a non-conductive wood support 0.1 meters in height. The system under test was connected to the power and signal wire according to relevant installation instructions.



9.4. Measurement equipment

Instrument/Ancillary	Manufacturer	Model No.	Serial No.	Calibration Date	Valid Date.
Signal Generator	R&S	SML03	103287	2015.03.29	2016.03.28
Power Sensor	R&S	NR P-Z91	100383	2015.03.29	2016.03.28
Power Sensor	R&S	NRP-Z91	100384	2015.03.29	2016.03.28
Power Meter	R&S	NRP	101206	2015.03.29	2016.03.28
Power Amplifier	BONN	BLWA0830-16 0/100/40D	076659	2015.03.29	2016.03.28
Istropic Electric Field Probe	EST.LINDGRE N	HI-6105	137445	2014.09.01	2015.09.01
EMS Antenna	R&S	HL046E	100028	N/A	N/A
Temperature/ Humidity Meter	feiyang	N/A	101	2015.04.02	2016.04.01
EMC-32	Rohde&Schwa rz	Ver 6.10.0	N/A	N/A	N/A



9.5. Test Result and Data

Basic Standard : IEC 61000-4-3
 Final Test Result : PASS
 Model No. : G2260VWQ6
 Pass performance criteria : A
 Frequency Range : 80~1000 MHz
 Temperature : 22°C
 Relative Humidity : 50 %
 Atmospheric Pressure : 100 kPa
 Test Date : Jun 15, 2015

Test Mode 1& Mode 4& Mode 7

Modulation : AM 80% , 1KHz sine wave , Dwell time: 3.0 S				
Frequency Step Size : 1 % of preceding frequency value				
Frequency (MHz)	Antenna Polarization	face	Field strength (V/m)	Result
80~1000	Vertical	Front	3 V/m	A
80~1000	Vertical	Rear	3 V/m	A
80~1000	Vertical	Left	3 V/m	A
80~1000	Vertical	Right	3 V/m	A
80~1000	Horizontal	Front	3 V/m	A
80~1000	Horizontal	Rear	3 V/m	A
80~1000	Horizontal	Left	3 V/m	A
80~1000	Horizontal	Right	3 V/m	A

Test engineer: Seben



9.6. Test Photographs





10. Electrical Fast Transient/ Burst Immunity Test

10.1. Test Procedure

- a. In order to minimize the effect of environmental parameters on test results, the climatic conditions when test is carrying out shall comply with the following requirements:
 - ✧ ambient temperature: 15□ to 35□;
 - ✧ relative humidity : 45% to 75%;
 - ✧ Atmospheric pressure: 86 Kpa (860 mbar) to 106 Kpa (1060 mbar).
- b. In order to minimize the effect of environmental parameters on test results, the electromagnetic environment of the laboratory shall not influence the test results.
- c. The variety and diversity of equipment and systems to be tested make it difficult to establish general criteria for the evaluation of the effects of fast transients/bursts on equipment and systems.
- d. Test on Power Line:
 - ✧ The EFT/B-generator was located on the GRP.
For floor standing equipment 1,0 m
For table top equipment 0,5 m
 - ✧ The EFT/B-generator provides the ability to apply the test voltage in a non-symmetrical condition to the power supply input terminals of the EUT.
- e. Test on Communication Lines
 - ✧ The coupling clamp is composed of a clamp unit for housing the cable (length more than 3 m), and was placed on the GRP.
 - ✧ The coupling clamp provides the ability of coupling the fast transient/bursts to the cable under test.
- f. The test results may be classified on the basic of the operating conditions and the functional specification of the equipment under test, according to the following performance criteria :
 - ✧ Normal performance within the specification limits.
 - ✧ Temporary degradation or loss of function or performance which is self-recoverable.
 - ✧ Temporary degradation or loss of function or performance which requires operator intervention or system reset.
 - ✧ Degradation or loss of function which is not recoverable due to damage of equipment (components).

10.2. Test Severity Levels

The following test severity levels are recommended for the fast transient/burst test :

Open circuit output test voltage ± 10%		
Level	On Power Supply	On I/O signal, data and control line
1	0.5 KV	0.25 KV
2	1.0 KV	0.50 KV
3	2.0 KV	1.00 KV
4	4.0 KV	2.00 KV
X	Specified	Specified

Remark : “ X ” is an open level. The level is subject to negotiation between the user and manufacturer or is specified by the manufacturer.



10.3. TEST SETUP

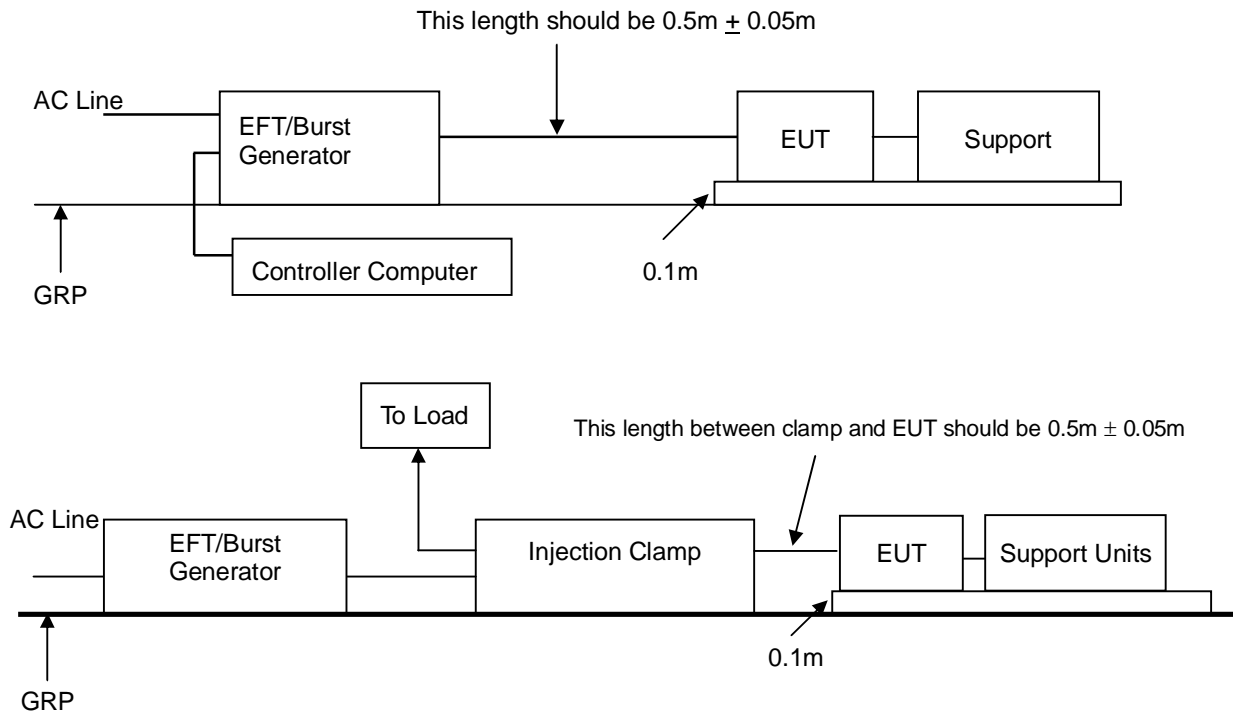

- For the actual test configuration, please refer to the related item – Photographs of the Test Configuration.

NOTE:

TABLETOP EQUIPMENT

The configuration consisted of a wooden table (0.1m high) standing on the Ground Reference Plane. The GRP consisted of a sheet of aluminum (at least 0.25mm thick and 2.5m square) connected to the protective grounding system. A minimum distance of 0.5m was provided between the EUT and the walls of the laboratory or any other metallic structure.

FLOOR STANDING EQUIPMENT

The EUT installed in a representative system as described in section 7 of IEC 61000-4-4 and its cables, were isolated from the Ground Reference Plane by an insulating support that is 0.1-meter thick. The GRP consisted of a sheet of aluminum (at least 0.25mm thick and 2.5m square) connected to the protective grounding system.

10.4. Measurement equipment

Instrument/Ancillary	Manufacturer	Model No.	Serial No.	Calibration Date	Valid Date.
TRANSIENT	EMCPARTNER	TRA2000IN6	901	2015.03.29	2016.03.28
CDN	EMCPARTNER	CDN2000-06-32	121	2015.03.29	2016.03.28
Coupling clamp	EMCPARTNER	CN-EFT1000	547	2015.03.29	2016.03.28
Temperature/ Humidity Meter	Zhicheng	ZC1-11	CEP-TH-005	2015.04.02	2016.04.01



10.5. Test Result and Data

Basic Standard : IEC 61000-4-4
 Final Test Result : PASS
 Model No. : G2260VWQ6
 Pass performance criteria : B
 Test Voltage : On Power Supply -- ±1.0 kV
 : On I/O signal, data and control line -- ±0.5 kV
 Temperature : 20°C
 Relative Humidity : 50 %
 Atmospheric Pressure : 100 kPa
 Test Date : Jun 16, 2015

Test Mode 1& Mode 4& Mode 7

Pulse : 5/50 ns					
Burst : 15m/300ms			Repetition Rate: <u>5 kHz</u>		
Test time : 1 min/each condition					
Voltage/ Mode/ Polarity/ Result/ Phase		<u>0.5 kV</u>		<u>1.0 kV</u>	
		+	-	+	-
Power Line	L	---	---	A	A
	N	---	---	A	A
	L-N	---	---	A	A
	PE	---	---	A	A
	L-PE	---	---	A	A
	N-PE	---	---	A	A
	L-N-PE	---	---	A	A

Test engineer: Seben



10.6. Test Photographs





11. Surge Immunity Test

11.1. Test Procedure

- a. Climatic conditions
The climatic conditions shall comply with the following requirements :
 - ✧ ambient temperature : 15 °C to 35 °C
 - ✧ relative humidity : 10 % to 75 %
 - ✧ atmospheric pressure : 86 kPa to 106 kPa (860 mbar to 1060 mbar)
- b. Electromagnetic conditions
the electromagnetic environment of the laboratory shall not influence the test results.
- c. The test shall be performed according the test plan that shall specify the test set-up with
 - ✧ generator and other equipment utilized;
 - ✧ test level (voltage/current);
 - ✧ generator source impedance;
 - ✧ internal or external generator trigger;
 - ✧ number of tests : at least five positive and five negative at the selected points;
 - ✧ repetition rate : maximum 1/min.
 - ✧ inputs and outputs to be tested;
 - ✧ representative operating conditions of the EUT;
 - ✧ sequence of application of the surge to the circuit;
 - ✧ phase angle in the case of AC. power supply;
 - ✧ actual installation conditions, for example :
AC : neutral earthed,
DC : (+) or (-) earthed to simulated the actual earthing conditions.
- d. If not otherwise specified the surges have to be applied synchronized to the voltage phase at the zero-crossing and the peak value of the AC. voltage wave (positive and negative).
- e. The surges have to be applied line to line and line(s) and earth. When testing line to earth, the test voltage has to be applied successively between each of the lines and earth, if there is no other specification.
- f. The test procedure shall also consider the non-linear current-voltage characteristics of the equipment under test. Therefore the test voltage has to be increased by steps up to the test level specified in the product standard or test plan.
- g. All lower levels including the selected test level shall be satisfied. For testing the secondary protection, the output voltage of the generator shall be increased up to the worst-case voltage breakdown level (let-through level) of the primary protection.
- h. If the actual operating signal sources are not available, that may be simulated. Under no circumstances may the test level exceed the product specification. The test shall be carried out according to a test plan.
- i. To find all critical points of the duty cycle of the equipment, a sufficient number of positive and negative test pulses shall be applied. For acceptance test previously unstressed equipment shall be used to the protection devices shall be replaced.

11.2. Test Severity Level

Level	Open-circuit test voltage, ± 10%, KV
1	0.5
2	1.0
3	2.0
4	4.0
X	Specified
NOTE: "X" is an open class. This level can be specified in the product specification.	



11.3. TEST SETUP

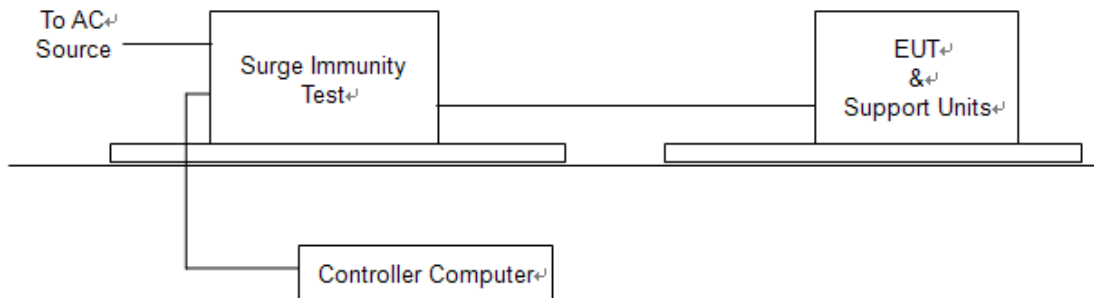

For the actual test configuration, please refer to the related item – Photographs of the Test Configuration.

11.4. Measurement equipment

Instrument/Ancillary	Manufacturer	Model No.	Serial No.	Calibration Date	Valid Date.
TRANSIENT	EMCPARTNER	TRA2000IN6	901	2015.03.29	2016.03.28
CDN	EMCPARTNER	CDN-UTP8	021	2015.03.29	2016.03.28
CDN	EMCPARTNER	CDN2000-06-32	121	2015.03.29	2016.03.28
Temperature/ Humidity Meter	Zhicheng	ZC1-11	CEP-TH-005	2015.04.02	2016.04.01



11.5. Test Result and Data

Basic Standard : IEC 61000-4-5
 Final Test Result : PASS
 Model No. : G2260VWQ6
 Pass performance criteria : B
 Test Voltage : Input AC Power Port -- ±0.5/1.0 kV for Line to Line
 Temperature : 20°C
 Relative Humidity : 50 %
 Atmospheric Pressure : 100 kPa
 Test Date : Jun 16, 2015

Power Port

Test Mode 1& Mode 4& Mode 7

Waveform : 1.2/50µs(8/20µs) Repetition rate : 60 sec Time : 20 time/each condition						
/Phase Voltage / Mode / Polarity / Result			0°	90°	180°	270°
0.5/1.0 kV	L-N	+	A	A	A	A
		-	A	A	A	A
0.5/1.0/2.0kV	L-PE	+	A	A	A	A
		-	A	A	A	A
	N-PE	+	A	A	A	A
		-	A	A	A	A

Test engineer Seben



11.6. Test Photographs





12. Conduction Disturbances induced by Radio-Frequency Fields

12.1. Test Procedure

- a. The EUT shall be operated within its intended climatic conditions. The temperature and relative humidity should be recorded.
- b. This test method test can be performed without using a sell shielded enclosure. This is because the disturbance levels applied and the geometry of the setups are not likely to radiated a high amount of energy, especially at the lower frequencies. If under certain circumstances the radiated energy is too high, a shielded enclosure has to be used.
- c. The test shall be performed with the test generator connected to each of the coupling and decoupling devices in turn while the other non-excited RF-input ports of the coupling devices are terminated by a 50 ohm load resistor.
- d. The frequency range is swept from 150 KHz to 80 MHz, using the signal levels established during the setting process, and with the disturbance signal 80% amplitude modulated with a 1KHz sign wave, pausing to adjust the RF-signal level or to switch coupling devices as necessary. The rate of sweep shall no exceed 1.5×10^{-3} decades/s. Where the frequency is swept incrementally, the step size shall no exceed 1% of the start and thereafter 1% of the preceding frequency value.
- e. The dwell time at each frequency shall not be less than the time necessary for the EUT to be exercised, and able to respond. Sensitive frequencies e.g. clock frequency (ies) and harmonics or frequencies of dominant interest shall be analyzed separately.
- f. An alternative test procedure may be adopted, wherein the frequency range is swept incrementally, with a step size not exceeding 4% of the start ad thereafter 4% of the preceding frequency value. The test level should be at least twice the value of the specified test level.
- g. In cases of dispute, the test procedure using a step size not exceeding 1% of the start and thereafter 1% of preceding frequency value shall take precedence.
- h. Attempts should be made to fully exercise the EUT during testing, and to fully interrogate all exercise modes selected for susceptibility.
- i. The use of special exercising programs is recommended.
- j. Testing shall be performed according to a Test Plan, which shall be included in the test report.
 - a. It may be necessary to carry out some investigatory testing in order to establish some aspects of the test plan.

12.2. Test Severity Levels

Level	Voltage Level (e.m.f.)
1	1 V
2	3 V
3	10 V
x	Specified
NOTE - x is an open class. This level can be specified in the product specification.	

12.3. TEST SETUP

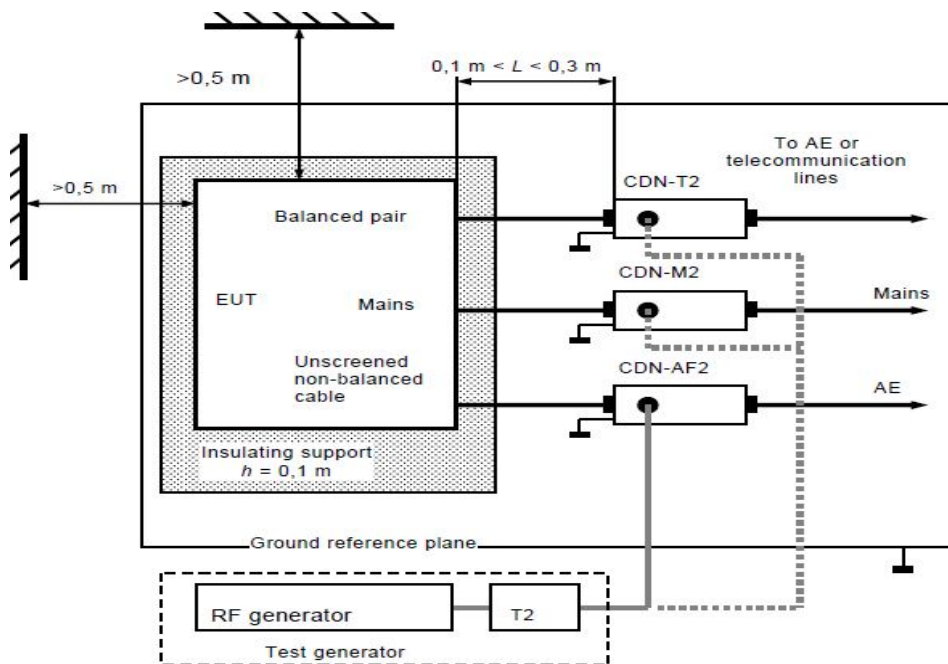

- Note:**
1. The EUT is setup 0.1m above Ground Reference Plane
 2. The CDNs and / or EM clamp used for real test depends on ports and cables configuration of EUT.
 3. For the actual test configuration, please refer to the related item – Photographs of the Test Configuration.



12.4. Measurement equipment

Instrument/Ancillary	Manufacturer	Model No.	Serial No.	Calibration Date	Valid Date.
Conducted immunity test system	FRANKONIA	CIT-10/75	102D1294	2015.03.29	2016.03.28
EM Injection clamp	FCC	F-203I-23MM	536	2015.03.29	2016.03.28
CDN	FRANKONIA	CDN-T2	A3010029	2015.03.29	2016.03.28
CDN	FRANKONIA	CDN-T4	A3015017	2015.03.29	2016.03.28
CDN	FRANKONIA	CDN-T8	A3022010	2015.03.29	2016.03.28
CDN	FRANKONIA	CDN-M2	A3002037	2015.03.29	2016.03.28
CDN	FRANKONIA	CDN-M2+M3	A3011102	2015.03.29	2016.03.28
CDN	FCC	CDN-M5/32	A3013024	2015.03.29	2016.03.28
6 dB Attenuator	FRANKONIA	N/A	N/A	2015.03.29	2016.03.28
Temperature/ Humidity Meter	Zhicheng	ZC1-11	CEP-TH-005	2015.04.02	2016.04.01
EN61000-4-6	Hubert GmbH	Ver 2.21	N/A	N/A	N/A



12.6. Test Photographs





13. Power Frequency Magnetic Field Immunity Tests

13.1. Test Setup

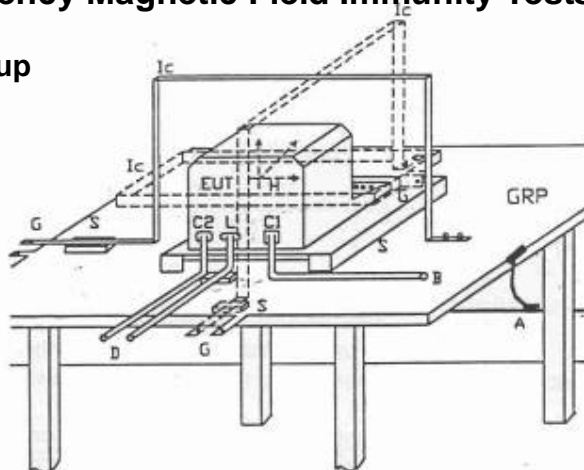

- GPR : Ground plane
- A : Safety earth
- S : Insulating support
- EUT : Equipment under test
- Lc : Induction coil
- E : Earth terminal
- C1 : Power supply circuit
- C2 : Signal circuit
- L : Communication line
- B : To power supply source
- D : To signal source, simulator
- G : To the test generator

13.2. Test Severity Levels

Level	Magnetic field strength (A/m)
1	1
2	3
3	10
4	30
5	100
X ¹⁾	special

NOTE 1 "X" is an open level. This level can be given in the product specification.

13.3. Measurement equipment

Instrument/Ancillary	Manufacturer	Model No.	Serial No.	Calibration Date	Valid Date.
TRANSIENT	EMCPARTNER	TRA2000IN6	901	2015.03.29	2016.03.28
H-Filed-Loop	EMCPARTNER	MF1000-1	144	2015.03.29	2016.03.28
Temperature/ Humidity Meter	Zhicheng	ZC1-11	CEP-TH-005	2015.04.02	2016.04.01



13.4. Test Result and Data

Basic Standard : IEC 61000-4-8
Final Test Result : PASS
Model No. : G2260VWQ6
Pass performance criteria : A
Temperature : 20°C
Relative Humidity : 50 %
Atmospheric Pressure : 100 kPa
Test Date : Jun 17, 2015

Test Mode 1 & Mode 4 & Mode 7

Power Frequency Magnetic Field : <u>50/60</u> Hz, <u>1</u> A/m		
Coil Orientation	Testing duration	Results
X-axis	1.0 Min	A
Y-axis	1.0 Min	A
Z-axis	1.0 Min	A

Test engineer: Seben



13.5. Test Photographs





14. Voltage Dips and Voltage Interruptions Immunity Test Setup

14.1. Test Conditions

1. Source voltage and frequency : AC 100/230/240V / 50Hz, Single phase.
2. Test of interval : 10 sec.
3. Level and duration : Sequence of 3 dips/interrupts.
4. Voltage rise (and fall) time : 1 ~ 5 μ s.
5. Test severity :

Voltage dips and Interrupt reduction (%)	Test Duration (period)
>95%	250
30%	25
>95%	0.5

14.2. TEST SETUP

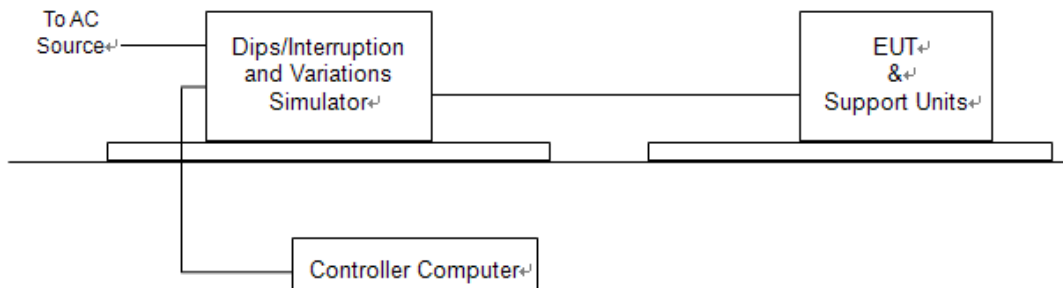

For the actual test configuration, please refer to the related item – Photographs of the Test Configuration.

14.3. Measurement equipment

Instrument/Ancillary	Manufacturer	Model No.	Serial No.	Calibration Date	Valid Date.
TRANSIENT	EMCPARTNER	TRA2000IN6	901	2015.03.29	2016.03.28
Temperature/ Humidity Meter	Zhicheng	ZC1-11	CEP-TH-005	2015.04.02	2016.04.01



14.4. Test Result and Data

Basic Standard : IEC 61000-4-11
 Final Test Result : PASS
 Model No. : G2260VWQ6
 Pass performance Criteria : C for voltage interruption, B for voltage dips
 Temperature : 20°C
 Relative Humidity : 50 %
 Atmospheric Pressure : 100 kPa
 Test Date : Jun 17, 2015

Test Mode 1 & Mode 4 & Mode 7										
Voltage(UT): AC 230 V/240V 50 Hz Interval(s) : 10s Times : 3										
Test mod	Test level UT %	Durations (period / ms)	Phase / Result							
			0	45	90	135	180	225	270	315
Voltage interruptions	>95%	250	C	C	C	C	C	C	C	C
Voltage dips	30%	25	B	B	B	B	B	B	B	B
	>95%	0.5	B	B	B	B	B	B	B	B

Test Mode 1 & Mode 4 & Mode 7										
Voltage(UT): AC 100 V 50 Hz Interval(s) : 10s Times : 3										
Test mod	Test level UT %	Durations (period / ms)	Phase / Result							
			0	45	90	135	180	225	270	315
Voltage interruptions	>95%	250	C	C	C	C	C	C	C	C
Voltage dips	30%	25	B	B	B	B	B	B	B	B
	>95%	0.5	B	B	B	B	B	B	B	B

Test engineer: Seben



14.5. Test Photographs





15. Photographs of EUT

1) EUT Photo

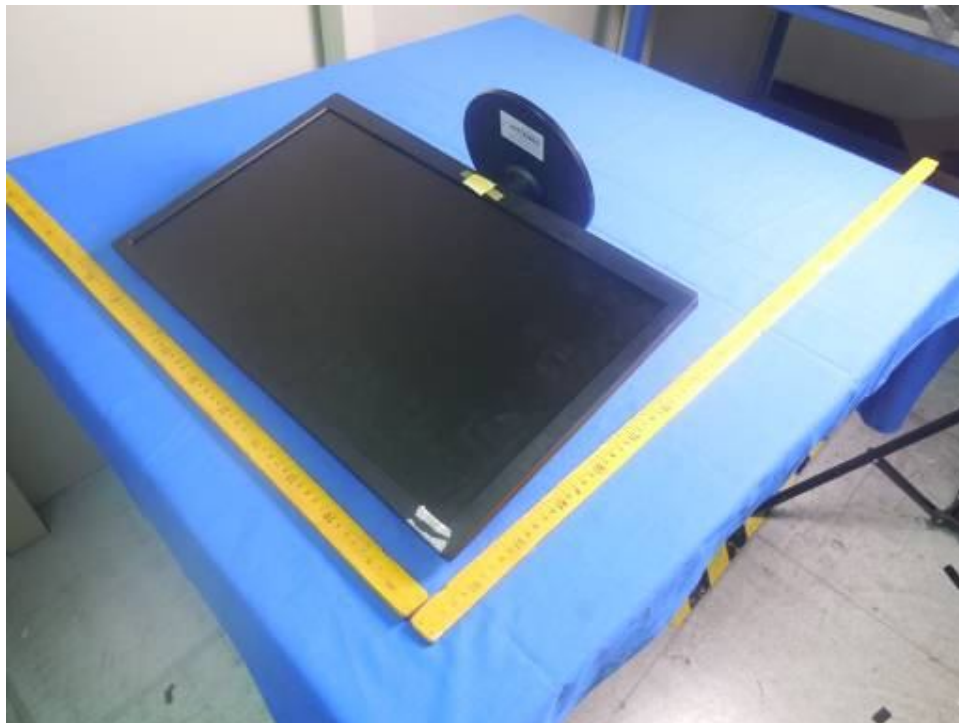

2) EUT Photo





3) EUT Photo



4) EUT Photo





5) EUT Photo



6) EUT Photo

