



EMC TEST REPORT

Authorized under Declaration of Conformity

According to

EN 55022 : 2010 (Class B)	EN 55024 : 2010
EN 61000-3-2 : 2006+A1:2009+A2:2009	IEC 61000-4-2 : 2008
EN 61000-3-3 : 2008	IEC 61000-4-3 : 2006+A1:2007+A2:2010
CISPR 22 : 2008	IEC 61000-4-4 : 2012
AS/NZS CISPR 22 : 2009	IEC 61000-4-5 : 2005
	IEC 61000-4-6 : 2008
	IEC 61000-4-8 : 2009
	IEC 61000-4-11 : 2004

Applicant	: TPV Electronics (Fujian) Co., Ltd.
Address	: Shangzheng, Yuanhong Road, Fuqing City, Fujian Province, P.R.China
Equipment	: LCD Monitor
Model No.	: 230LM00024; I2360***

- The test result refers exclusively to the test presented test model / sample.
- Without written approval of **CerpPASS Technology(Suzhou) Corp.** the test report shall not be reproduced except in full.
- The test report must not be used by the clients to claim product certification approval by **NVLAP** or any agency of the Government.



Contents

CERTIFICATE OF COMPLIANCE	5
1. Summary of Test Procedure and Test Results	6
2. Immunity Testing Performance Criteria Definition	7
3. Test Configuration of Equipment under Test	8
3.1. Feature of Equipment under Test.....	8
3.2. Test Mode and Test Manner.....	8
3.3. Description of Support Unit	9
3.4. General Information of Test.....	10
3.5. Measurement Uncertainty	10
4. Test of Conducted Emission	11
4.1. Test Limit	11
4.2. Test Procedures	12
4.3. Typical Test Setup	12
4.4. Measurement equipment	13
4.5. Test Data and Result.....	14
4.6. Test Photographs	20
5. Test of Radiated Emission	21
5.1. Test Limit	21
5.2. Test Procedures	22
5.3. Typical test Setup.....	23
5.4. Measurement equipment	24
5.5. Test Result and Data (30MHz ~ 1000MHz)	25
5.6. Test Result and Data (1000MHz ~ 6000MHz)	31
5.7. Test Photographs (30MHz ~ 1000MHz).....	37
5.8. Test Photographs (1000MHz ~ 6000MHz).....	38
6. Harmonics Test	39
6.1. Limits Of Harmonics Current Measurement.....	39
6.2. Measurement equipment	39
6.3. Test Result and Data.....	40
6.4. Test Photographs	46
7. Voltage Fluctuations Test	47
7.1. Test Procedure	47
7.2. Measurement equipment	47
7.3. Test Result and Data.....	48
7.4. Test Photographs	54
8. Electrostatic Discharge Immunity Test	55
8.1. Test Procedure	55
8.2. Test Setup for Tests Performed in Laboratory.....	56
8.3. Test Severity Levels	57
8.4. Measurement equipment	57
8.5. Test Result and Data.....	58



8.6. Test Photographs 59

9. Radio Frequency electromagnetic field immunity test 60

9.1. Test Procedure 60

9.2. Test Severity Levels 61

9.3. Measurement equipment 61

9.4. Test Result and Data 62

9.5. Test Photographs 63

10. Electrical Fast Transient/ Burst Immunity Test 64

10.1. Test Procedure 64

10.2. Test Severity Levels 65

10.3. Measurement equipment 65

10.4. Test Result and Data 66

10.5. Test Photographs 67

11. Surge Immunity Test 68

11.1. Test Procedure 68

11.2. Test Severity Level 69

11.3. Measurement equipment 69

11.4. Test Result and Data 70

11.5. Test Photographs 71

12. Conduction Disturbances induced by Radio-Frequency Fields 72

12.1. Test Procedure 72

12.2. Test Severity Levels 73

12.3. Measurement equipment 73

12.4. Test Result and Data 74

12.5. Test Photographs 75

13. Power Frequency Magnetic Field Immunity Tests 76

13.1. Test Setup 76

13.2. Test Severity Levels 76

13.3. Measurement equipment 76

13.4. Test Result and Data 77

13.5. Test Photographs 78

14. Voltage Dips and Voltage Interruptions Immunity Test Setup 79

14.1. Test Conditions 79

14.2. Measurement equipment 79

14.3. Test Result and Data 80

14.4. Test Photographs 81

15. Photographs of EUT 82



History of this test report

ORIGINAL.

Additional attachment as following record:

Attachment No.	Date	Description



CERTIFICATE OF COMPLIANCE

According to

EN 55022 : 2010 (Class B)	EN 55024 : 2010
EN 61000-3-2 : 2006+A1:2009+A2:2009	IEC 61000-4-2 : 2008
EN 61000-3-3 : 2008	IEC 61000-4-3 : 2006+A1:2007+A2:2010
CISPR 22 : 2008	IEC 61000-4-4 : 2012
AS/NZS CISPR 22 : 2009	IEC 61000-4-5 : 2005
	IEC 61000-4-6 : 2008
	IEC 61000-4-8 : 2009
	IEC 61000-4-11 : 2004

Applicant : TPV Electronics (Fujian) Co., Ltd.
Address : Shangzheng, Yuanhong Road, Fuqing City, Fujian Province, P.R.China
Equipment : LCD Monitor
Model No. : 230LM00024; I2360***

I HEREBY CERTIFY THAT :

The measurements shown in this test report were made in accordance with the procedures given in **EUROPEAN COUNCIL DIRECTIVE 2004/108/EC.**

The test was carried out on Jul 23, 2013 at **CerpPASS Technology(Suzhou) Corp.**

Signature

Miro Chueh/ Technical director



1. Summary of Test Procedure and Test Results

Test Item	Normative References	Test Result	Remarks
Conducted Emission	EN 55022:2010	PASS	Meets Class B Limit Minimum passing margin(AV) is -10.82 dB at 3.0580 MHz
Radiated Emission	EN 55022:2010	PASS	Meets Class B Limit Minimum passing margin(QP) is -4.11 dB at 595.1200 MHz
Harmonics	EN 61000-3-2 : 2006+A1:2009+A2:2009	PASS	Meets the requirements.
Voltage Fluctuations	EN 61000-3-3: 2008	PASS	Meets the requirements.
Electrostatic Discharge Immunity Test (ESD)	IEC 61000-4-2 :2008	PASS	Meets the requirements of performance criterion B
Radio Frequency electromagnetic field immunity test (RS)	IEC 61000-4-3 : 2006+A1:2007+A2:2010	PASS	Meets the requirements of performance criterion A
Electrical Fast Transient/ Burst Immunity Test (EFT)	IEC 61000-4-4 : 2012	PASS	Meets the requirements of performance criterion B
Surge Immunity Test	IEC 61000-4-5 : 2005	PASS	Meets the requirements of performance criterion B
Conduction Disturbances induced by Radio-Frequency Fields	IEC 61000-4-6 : 2008	PASS	Meets the requirements of performance criterion A
Power Frequency Magnetic Field Immunity Test	IEC 61000-4-8 : 2009	PASS	Meets the requirements of performance criterion A
Voltage Dips and Voltage Interruptions Immunity Test	IEC 61000-4-11 : 2004	PASS	Meets the requirements: Voltage Dips: 1) >95% reduction – Performance Criterion B 2) 30% reduction – Performance Criterion C Voltage Interruptions: 1) >95% reduction – Performance Criterion C



2. Immunity Testing Performance Criteria Definition

- A. Normal performance within limits specified by the manufacture, requestor or purchaser;
- B. Temporary loss of function or degradation of performance which ceases after the disturbance ceases, and from which the equipment under test recovers its normal performance, without operator intervention;
- C. Temporary loss of function or degradation of performance, the correction of which requires operation intervention;
- D. Loss of function or degradation of performance which is not recoverable, owing to damage to hardware or software, or loss of data.



3. Test Configuration of Equipment under Test

3.1. Feature of Equipment under Test

LCD Monitor	Model No.:	230LM00024; I2360***
Power Cable	Non-shielding, 1.2m&1.5m&1.8m	

3.2. Test Mode and Test Manner

Test Manner

- a During testing, the interface cables and equipment positions were varied according to Europe Standard.
- b Running "H" pattern.
- c During the test, connect the Keyboard , Mouse, Earphone, PC and EUT, make the EUT at the test mode.
- d Adjust the EUT, then test.

The pre-test modes

- Test Mode 1: Full System (VGA Mode 1920*1080@60Hz)
- Test Mode 2: Full system (VGA mode 1280*1024@75Hz)
- Test Mode 3: Full system (VGA mode 640*480@60Hz)
- Test Mode 4: Full System (HDMI Mode 1920*1080@60Hz)
- Test Mode 5: Full system (HDMI mode 1280*1024@75Hz)
- Test Mode 6: Full system (HDMI mode 640*480@60Hz)
- Test Mode 7: Full System (DVI Mode 1920*1080@60Hz)
- Test Mode 8: Full system (DVI mode 1280*1024@75Hz)
- Test Mode 9: Full system (DVI mode 640*480@60Hz)
- Test Mode 10: DVD 1080P for horizontal

The worse case was selected as the final test mode and record in the report

- Test Mode 1: Full System (VGA Mode 1920*1080@60Hz)
- Test Mode 4: Full System (HDMI Mode 1920*1080@60Hz)
- Test Mode 7: Full System (DVI Mode 1920*1080@60Hz)



3.3. Description of Support Unit

No.	Device	Manufacturer	Model No.	Description
1	PC	Dell	DCMF	N/A
2	USB Keyboard	DELL	SK-8115	N/A
3	USB Mouse	DELL	G0K02XYK	N/A
4	Earphone	SALAR	N/A	N/A

No.	Cable	Quantity	Description
A	VGA Cable	1	Shielded, 1.2m&1.5m&1.8m, with two ferrites core bonded
B	DVI Cable	1	Shielded, 1.2m&1.5m&1.8m, with two ferrites core bonded
C	HDMI Cable	1	Shielded, 1.2m&1.5m&1.8m
D	Audio Cable	1	Non-Shielded, 1.8m
E	USB Cable	1	Shielded, 1.8m, with one ferrite core bonded
F	USB Cable	1	Shielded, 1.2m



3.4. General Information of Test

Test Site:	Cerpass Technology (Suzhou) Co.,Ltd
Test Site Location :	No.66,Tangzhuang Road, Suzhou Industrial Park, Jiangsu 215006, China
NVLAP LAB Code :	200814-0
FCC Registration Number :	916572, 331395
IC Registration Number :	7290A-1, 7290A-2
VCCI Registration Number :	T-1945 for Telecommunication Test C-2919 for Conducted emission test R-2670 for Radiated emission test below 1GHz G-227 for Radiated emission test above 1GHz
Frequency Range Investigated :	Conducted Emission Test: from 150kHz to 30 MHz Radiated Emission Test: from 30 MHz to 1,000 MHz Radiated Emission Test: from 1GHz to 6GHz
Test Distance :	The test distance of radiated emission below 1GHz from antenna to EUT is 10 M. The test distance of radiated emission above 1GHz from antenna to EUT is 3 M.

LABORATORY ACCREDITATION



3.5. Measurement Uncertainty

Conducted Emission		
The measurement uncertainty is evaluated as ± 2.71 dB.		
Radiated Emission		
(30MHz -1000MHz)	Horizontal	The measurement uncertainty is evaluated as ± 3.59 dB.
	Vertical	The measurement uncertainty is evaluated as ± 3.89 dB
(1GHz-6GHz)	Horizontal	The measurement uncertainty is evaluated as ± 2.31 dB.
	Vertical	The measurement uncertainty is evaluated as ± 2.15 dB.



4. Test of Conducted Emission

4.1. Test Limit

Conducted Emissions were measured from 150 kHz to 30 MHz with a bandwidth of 9 kHz and return leads of the EUT according to the methods defined in European Standard EN 55022. The EUT was placed on a nonmetallic stand in a shielded room 0.8 meters above the ground plane as shown in standard. The interface cables and equipment positioning were varied within limits of reasonable applications to determine the position producing maximum conducted emissions.

Table 1 Class B Line Conducted Emission Limits:

Frequency range (MHz)	Limits (dB μ V)	
	Quasi Peak	Average
0.15 to 0.50	66 to 56	56 to 46
0.50 to 5	56	46
5. to 30.	60	50

Note 1: The lower limits shall apply at the transition frequencies.
 Note 2: The limit decreases linearly with the logarithm of the frequency in the range 0.15 MHz to .50MHz.

Table 2 - Limits of conducted common mode (asymmetric mode) disturbance at telecommunication ports in the frequency range 0.15 MHz to 30 MHz for class B equipment.

Frequency range (MHz)	Voltage limits dB(μ V)		Current limits dB(μ A)	
	Quasi-peak	Average	Quasi-peak	Average
0.15 to 0.5	84 to 74	74 to 64	40 to 30	30 to 20
0.5 to 30	74	64	30	20

Note 1: The limits decrease linearly with the logarithm of the frequency in the range 0.15 to 0.5 MHz.
 Note 2: The current and voltage disturbance limits are derived for use with an impedance stabilization network (ISN) which presents a common mode (asymmetric mode) impedance of 150 Ω to the telecommunication under test (conversion factor is $20 \log_{10} 150/1 = 44$ dB).



4.2. Test Procedures

- a. The EUT was placed on a desk 0.8 meters height from the metal ground plane and 0.4 meter from the conducting wall of the shielding room and it was kept at least 0.8 meters from any other grounded conducting surface.
- b. Connect EUT to the power mains through a line impedance stabilization network (LISN).
- c. All the support units are connecting to the other LISN.
- d. The LISN provides 50 ohm coupling impedance for the measuring instrument.
- e. The CISPR states that a 50 ohm, 50 micro-Henry LISN should be used.
- f. Both sides of AC line were checked for maximum conducted interference.
- g. The frequency range from 150 kHz to 30 MHz was searched
- h. Set the test-receiver system to Peak Detect Function and Specified Bandwidth with Maximum Hold Mode.

4.3. Typical Test Setup

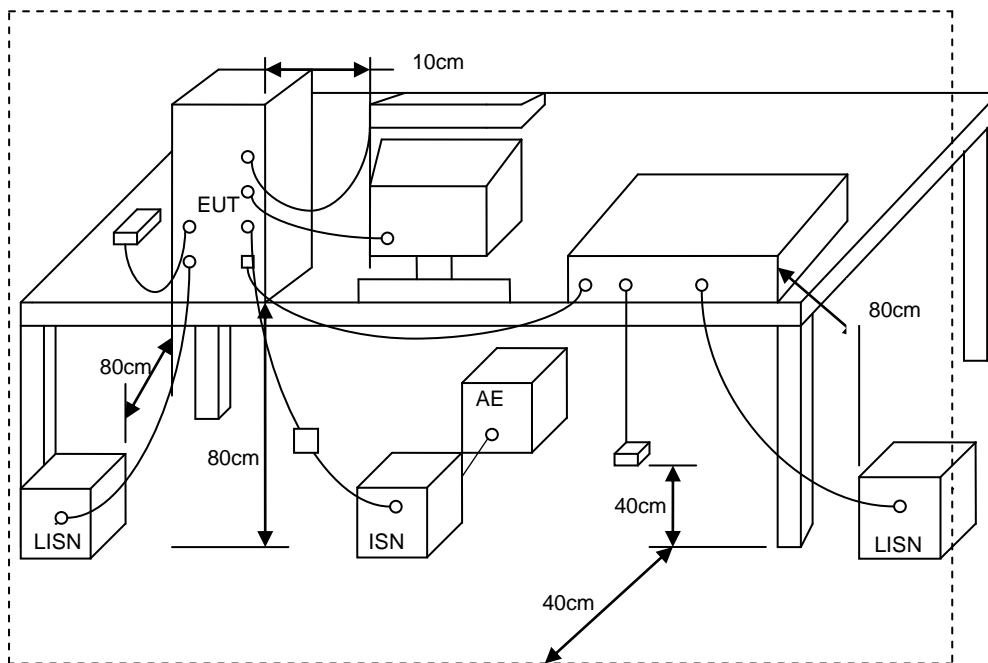



4.4. Measurement equipment

Instrument/Ancillary	Manufacturer	Model No.	Serial No.	Calibration Date	Valid Date.
Test Receiver	R&S	ESCI	100565	2012.11.05	2013.11.04
AMN	R&S	ESH2-Z5	100182	2012.11.05	2013.11.04
Two-Line V-Network	R&S	ENV216	100325	2013.03.10	2014.03.09
ISN	FCC	FCC-TLISN-T2-02	20379	2012.12.08	2013.12.07
ISN	FCC	FCC-TLISN-T4-02	20380	2012.12.08	2013.12.07
ISN	FCC	FCC-TLISN-T8-02	20381	2012.12.08	2013.12.07
ISN	TESEQ	ISN ST08	30175	2012.09.13	2013.09.12
Current Probe	R&S	EZ-17	100303	2013.03.10	2014.03.09
Passive Voltage Probe	R&S	ESH2-Z3	100026	2013.03.10	2014.03.09
Attenuator	R&S	ESH3-Z2	100529	2013.03.10	2014.03.09
Temperature/ Humidity Meter	Zhicheng	ZC1-11	CEP-TH-004	2013.03.10	2014.03.09



4.5. Test Data and Result

Test Mode :	Test Mode 1: Full System (VGA Mode 1920*1080@60Hz)		
AC Power :	AC 230V/50Hz	Phase :	LINE
Equipment :	LCD Monitor	Model No :	230LM00024
Temperature :	22°C	Humidity :	50%
Pressure(mbar) :	1002	Date:	2013/07/23

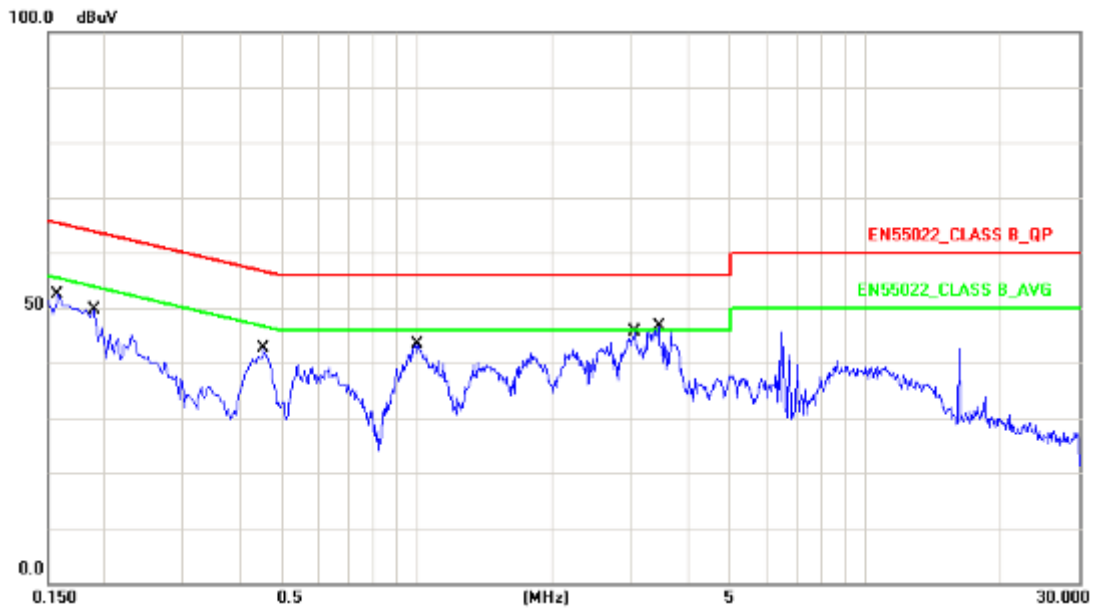

No.	Frequency (MHz)	Factor (dB)	Reading (dBuV)	Level (dBuV)	Limit (dBuV)	Margin (dB)	Detector
1	0.1580	9.87	37.43	47.30	65.56	-18.26	QP
2	0.1580	9.87	27.44	37.31	55.56	-18.25	AVG
3	0.1900	9.87	32.86	42.73	64.03	-21.30	QP
4	0.1900	9.87	22.53	32.40	54.03	-21.63	AVG
5	0.4540	9.85	28.46	38.31	56.80	-18.49	QP
6	0.4540	9.85	23.78	33.63	46.80	-13.17	AVG
7	1.0020	9.75	28.65	38.40	56.00	-17.60	QP
8	1.0020	9.75	23.10	32.85	46.00	-13.15	AVG
9	3.0579	9.71	29.03	38.74	56.00	-17.26	QP
10	3.0579	9.71	23.18	32.89	46.00	-13.11	AVG
11	3.4620	9.71	29.99	39.70	56.00	-16.30	QP
12	3.4620	9.71	24.98	34.69	46.00	-11.31	AVG

Note: Measurement Level = Reading Level + Correct Factor



Test Mode :	Test Mode 1: Full System (VGA Mode 1920*1080@60Hz)		
AC Power :	AC 230V/50Hz	Phase :	NEUTRAL
Equipment :	LCD Monitor	Model No :	230LM00024
Temperature :	22°C	Humidity :	50%
Pressure(mbar) :	1002	Date:	2013/07/23

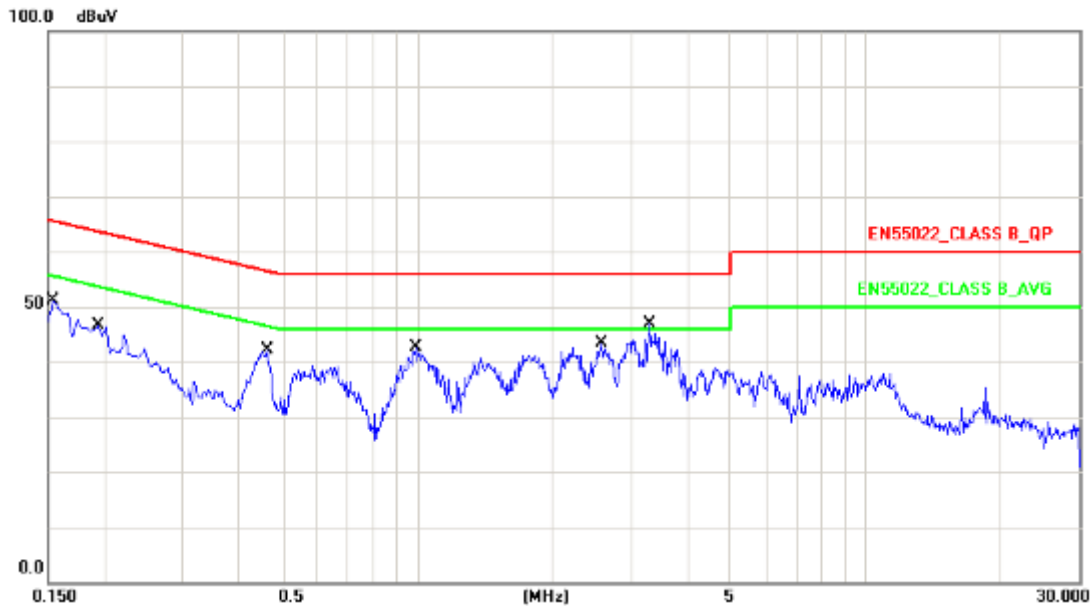

No.	Frequency (MHz)	Factor (dB)	Reading (dBuV)	Level (dBuV)	Limit (dBuV)	Margin (dB)	Detector
1	0.1539	9.50	36.58	46.08	65.78	-19.70	QP
2	0.1539	9.50	26.61	36.11	55.78	-19.67	AVG
3	0.1940	9.50	31.02	40.52	63.86	-23.34	QP
4	0.1940	9.50	21.34	30.84	53.86	-23.02	AVG
5	0.4620	9.50	28.43	37.93	56.66	-18.73	QP
6	0.4620	9.50	23.64	33.14	46.66	-13.52	AVG
7	0.9980	9.44	29.38	38.82	56.00	-17.18	QP
8	0.9980	9.44	24.06	33.50	46.00	-12.50	AVG
9	2.5940	9.53	28.87	38.40	56.00	-17.60	QP
10	2.5940	9.53	23.36	32.89	46.00	-13.11	AVG
11	3.2940	9.56	30.85	40.41	56.00	-15.59	QP
12	3.2940	9.56	25.63	35.19	46.00	-10.81	AVG

Note: Measurement Level = Reading Level + Correct Factor



Test Mode :	Test Mode 4: Full System (HDMI Mode 1920*1080@60Hz)		
AC Power :	AC 230V/50Hz	Phase :	LINE
Equipment :	LCD Monitor	Model No :	230LM00024
Temperature :	22 °C	Humidity :	50%
Pressure(mbar) :	1002	Date:	2013/07/23

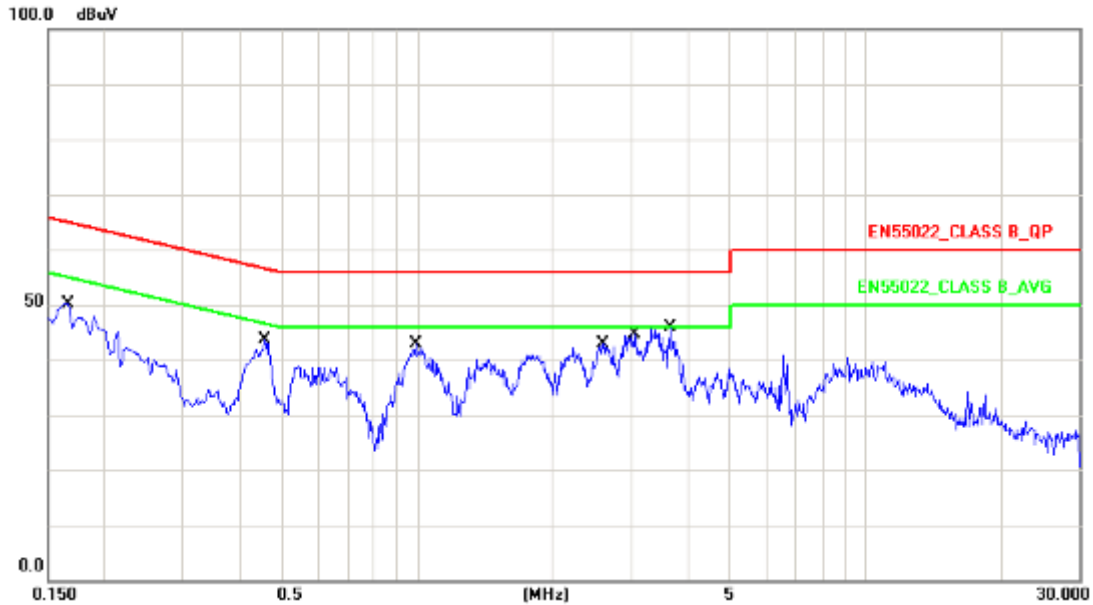

No.	Frequency (MHz)	Factor (dB)	Reading (dBuV)	Level (dBuV)	Limit (dBuV)	Margin (dB)	Detector
1	0.1660	9.87	35.71	45.58	65.16	-19.58	QP
2	0.1660	9.87	26.42	36.29	55.16	-18.87	AVG
3	0.4580	9.85	28.95	38.80	56.73	-17.93	QP
4	0.4580	9.85	24.13	33.98	46.73	-12.75	AVG
5	0.9900	9.75	29.09	38.84	56.00	-17.16	QP
6	0.9900	9.75	23.73	33.48	46.00	-12.52	AVG
7	2.5980	9.71	28.69	38.40	56.00	-17.60	QP
8	2.5980	9.71	23.22	32.93	46.00	-13.07	AVG
9	3.0580	9.71	31.25	40.96	56.00	-15.04	QP
10	3.0580	9.71	25.47	35.18	46.00	-10.82	AVG
11	3.6660	9.70	25.36	35.06	56.00	-20.94	QP
12	3.6660	9.70	17.18	26.88	46.00	-19.12	AVG

Note: Measurement Level = Reading Level + Correct Factor



Test Mode :	Test Mode 4: Full System (HDMI Mode 1920*1080@60Hz)		
AC Power :	AC 230V/50Hz	Phase :	NEUTRAL
Equipment :	LCD Monitor	Model No :	230LM00024
Temperature :	22 °C	Humidity :	50%
Pressure(mbar) :	1002	Date:	2013/07/23

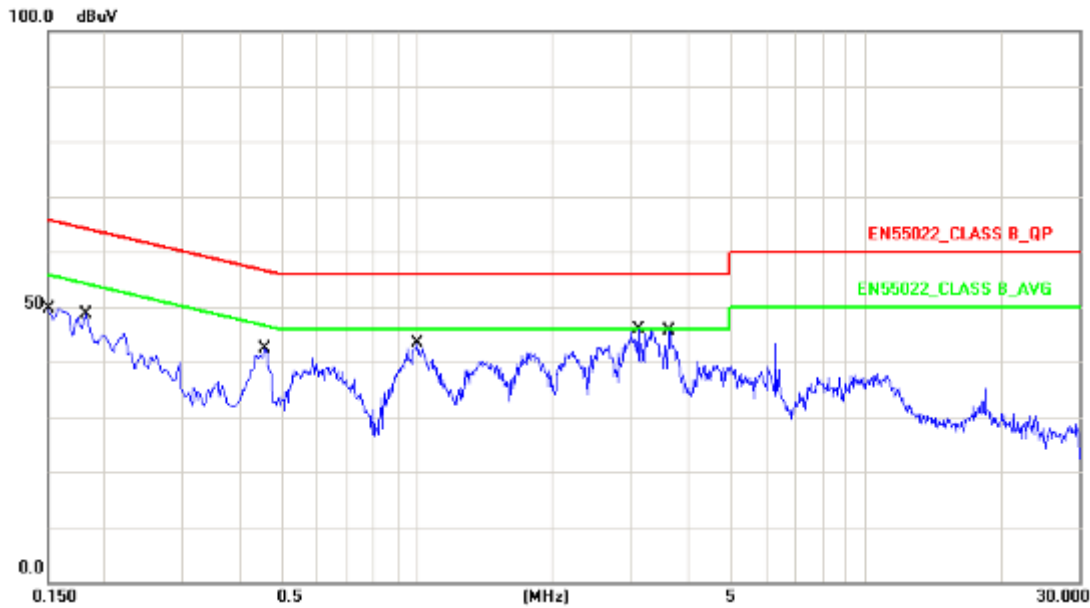

No.	Frequency (MHz)	Factor (dB)	Reading (dBuV)	Level (dBuV)	Limit (dBuV)	Margin (dB)	Detector
1	0.1500	9.50	35.83	45.33	65.99	-20.66	QP
2	0.1500	9.50	25.18	34.68	55.99	-21.31	AVG
3	0.1819	9.50	32.54	42.04	64.39	-22.35	QP
4	0.1819	9.50	23.04	32.54	54.39	-21.85	AVG
5	0.4580	9.50	28.87	38.37	56.73	-18.36	QP
6	0.4580	9.50	24.11	33.61	46.73	-13.12	AVG
7	1.0020	9.44	29.06	38.50	56.00	-17.50	QP
8	1.0020	9.44	23.82	33.26	46.00	-12.74	AVG
9	3.1180	9.55	27.43	36.98	56.00	-19.02	QP
10	3.1180	9.55	21.33	30.88	46.00	-15.12	AVG
11	3.6420	9.58	25.38	34.96	56.00	-21.04	QP
12	3.6420	9.58	18.14	27.72	46.00	-18.28	AVG

Note: Measurement Level = Reading Level + Correct Factor



Test Mode :	Test Mode 7: Full System (DVI Mode 1920*1080@60Hz)		
AC Power :	AC 230V/50Hz	Phase :	LINE
Equipment :	LCD Monitor	Model No :	230LM00024
Temperature :	22 °C	Humidity :	50%
Pressure(mbar) :	1002	Date:	2013/07/23

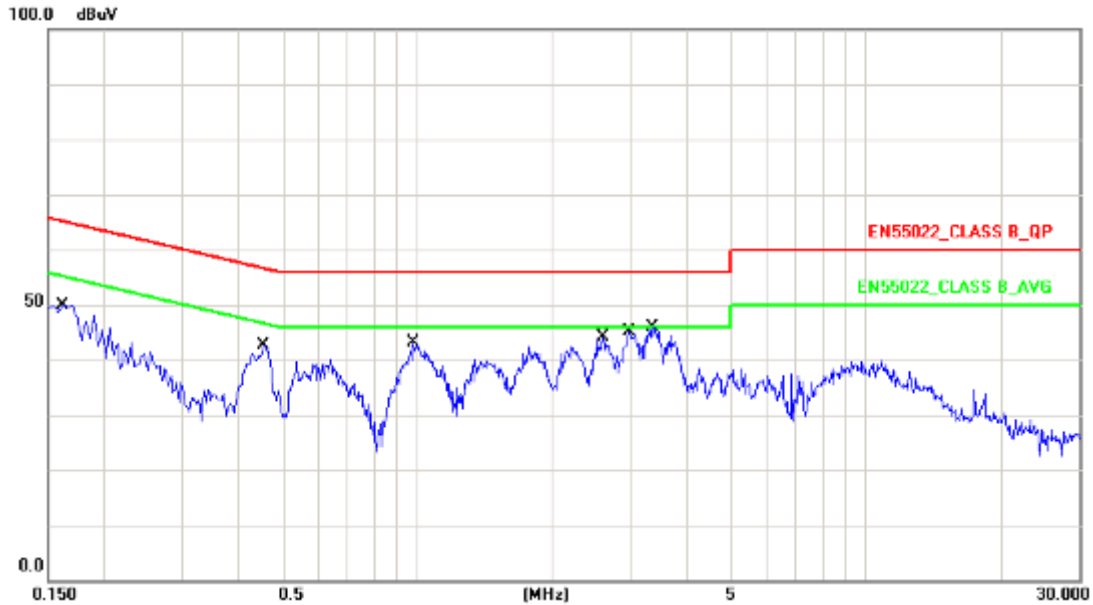

No.	Frequency (MHz)	Factor (dB)	Reading (dBuV)	Level (dBuV)	Limit (dBuV)	Margin (dB)	Detector
1	0.1620	9.87	36.43	46.30	65.36	-19.06	QP
2	0.1620	9.87	27.03	36.90	55.36	-18.46	AVG
3	0.4540	9.85	28.86	38.71	56.80	-18.09	QP
4	0.4540	9.85	24.07	33.92	46.80	-12.88	AVG
5	0.9820	9.76	28.50	38.26	56.00	-17.74	QP
6	0.9820	9.76	23.10	32.86	46.00	-13.14	AVG
7	2.6020	9.71	28.94	38.65	56.00	-17.35	QP
8	2.6020	9.71	23.29	33.00	46.00	-13.00	AVG
9	2.9620	9.71	29.50	39.21	56.00	-16.79	QP
10	2.9620	9.71	22.87	32.58	46.00	-13.42	AVG
11	3.3500	9.71	30.31	40.02	56.00	-15.98	QP
12	3.3500	9.71	22.74	32.45	46.00	-13.55	AVG

Note: Measurement Level = Reading Level + Correct Factor



Test Mode :	Test Mode 7: Full System (DVI Mode 1920*1080@60Hz)		
AC Power :	AC 230V/50Hz	Phase :	NEUTRAL
Equipment :	LCD Monitor	Model No :	230LM00024
Temperature :	22°C	Humidity :	50%
Pressure(mbar) :	1002	Date:	2013/07/23

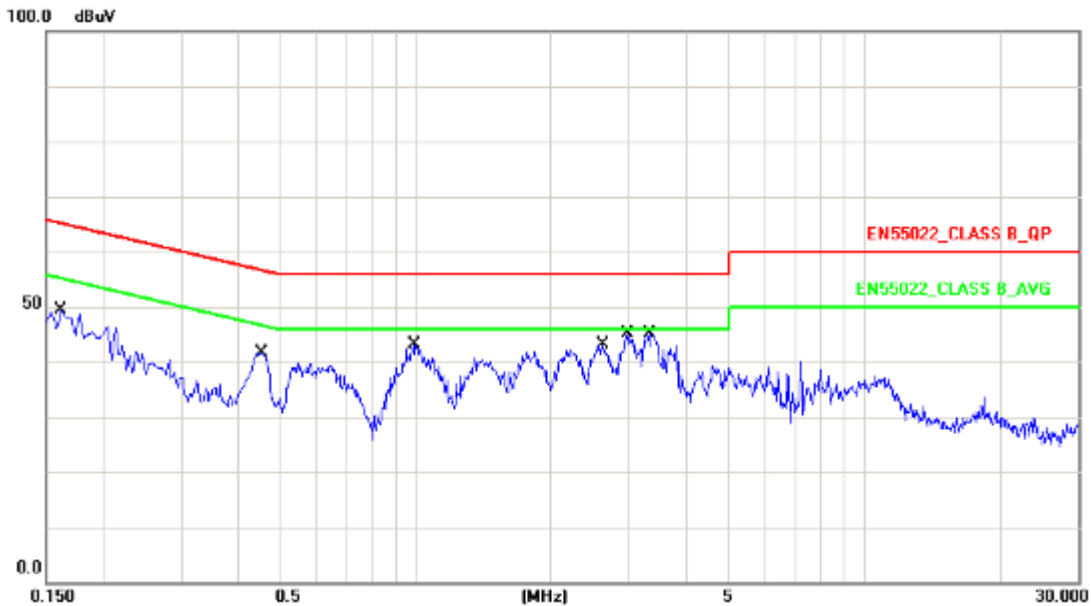

No.	Frequency (MHz)	Factor (dB)	Reading (dBuV)	Level (dBuV)	Limit (dBuV)	Margin (dB)	Detector
1	0.1620	9.50	35.23	44.73	65.36	-20.63	QP
2	0.1620	9.50	26.24	35.74	55.36	-19.62	AVG
3	0.4540	9.50	29.15	38.65	56.80	-18.15	QP
4	0.4540	9.50	24.35	33.85	46.80	-12.95	AVG
5	0.9900	9.44	29.36	38.80	56.00	-17.20	QP
6	0.9900	9.44	24.31	33.75	46.00	-12.25	AVG
7	2.6220	9.53	28.77	38.30	56.00	-17.70	QP
8	2.6220	9.53	23.38	32.91	46.00	-13.09	AVG
9	2.9700	9.55	29.48	39.03	56.00	-16.97	QP
10	2.9700	9.55	23.12	32.67	46.00	-13.33	AVG
11	3.3420	9.56	30.24	39.80	56.00	-16.20	QP
12	3.3420	9.56	24.30	33.86	46.00	-12.14	AVG

Note: Measurement Level = Reading Level + Correct Factor

Test engineer: *Seben*



4.6. Test Photographs

Front View



Rear View





5. Test of Radiated Emission

5.1. Test Limit

The EUT shall meet the limits of below Table when measured at the measuring distance R in accordance with the methods described in European Standard EN 55022. If the reading on the measuring receiver shows fluctuations close to the limit, the reading shall be observed for at least 15 s at each measurement frequency; the highest reading shall be recorded, with the exception of any brief isolated high reading, which shall be ignored.

Table – Limits for radiated disturbance of class B ITE at a measuring distance of 10 m

Frequency range MHz	Quasi-peak limits dB(μ V/m)
30 to 230	30
230 to 1000	37
NOTE 1 The lower limit shall apply at the transition frequency. NOTE 2 Additional provisions may be required for cases where interference occurs.	

The EUT shall meet the limits of below Table when measured in accordance with the method described in European Standard EN 55022 and the conditional testing procedure described below.

Table – Limits for radiated disturbance of class B ITE at a measuring distance of 3 m

Frequency range GHz	Average limit dB(μ V/m)	Peak limits dB(μ V/m)
1 to 3	50	70
3 to 6	54	74
NOTE The lower limit applies at the transition frequency.		

• Conditional testing procedure:

The highest internal source of an EUT is defined as the highest frequency generated or used within the EUT or on which the EUT operates or tunes.

If the highest frequency of the internal sources of the EUT is less than 108 MHz, the measurement shall only be made up to 1 GHz.

If the highest frequency of the internal sources of the EUT is between 108 MHz and 500 MHz, the measurement shall only be made up to 2 GHz.

If the highest frequency of the internal sources of the EUT is between 500 MHz and 1 GHz, the measurement shall only be made up to 5 GHz.

If the highest frequency of the internal sources of the EUT is above 1 GHz, the measurement shall be made up to 5 times the highest frequency or 6 GHz, whichever is less.



5.2. Test Procedures

- a. The EUT was placed on a relatable table top 0.8 meter above ground.
- b. The EUT was set 10 meters from the interference receiving antenna which was mounted on the top of a variable height antenna tower.
- c. The table was rotated 360 degrees to determine the position of the highest radiation.
- d. The antenna is a half wave dipole and its height is varied between one meter and four meters above ground to find the maximum value of the field strength both horizontal polarization and vertical polarization of the antenna are set to make the measurement.
- e. For each suspected emission the EUT was arranged to its worst case and then tune the antenna tower (from 1 M to 4 M) and turn table (from 0 degree to 360 degrees) to find the maximum reading.
- f. Set the test-receiver system to Peak Detect Function and specified bandwidth with Maximum Hold Mode.
- g. If the emission level of the EUT in peak mode was 3 dB lower than the limit specified, then testing will be stopped and peak values of EUT will be reported, otherwise, the emissions which do not have 3 dB margin will be repeated one by one using the quasi-peak method and reported.



5.3. Typical test Setup

Below 1GHz Test Setup

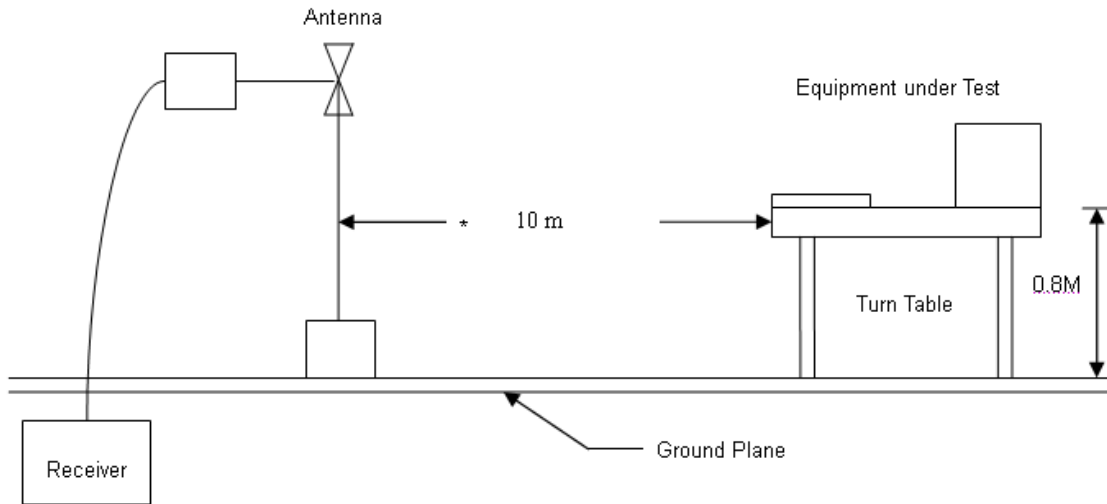

Above 1GHz Test Setup

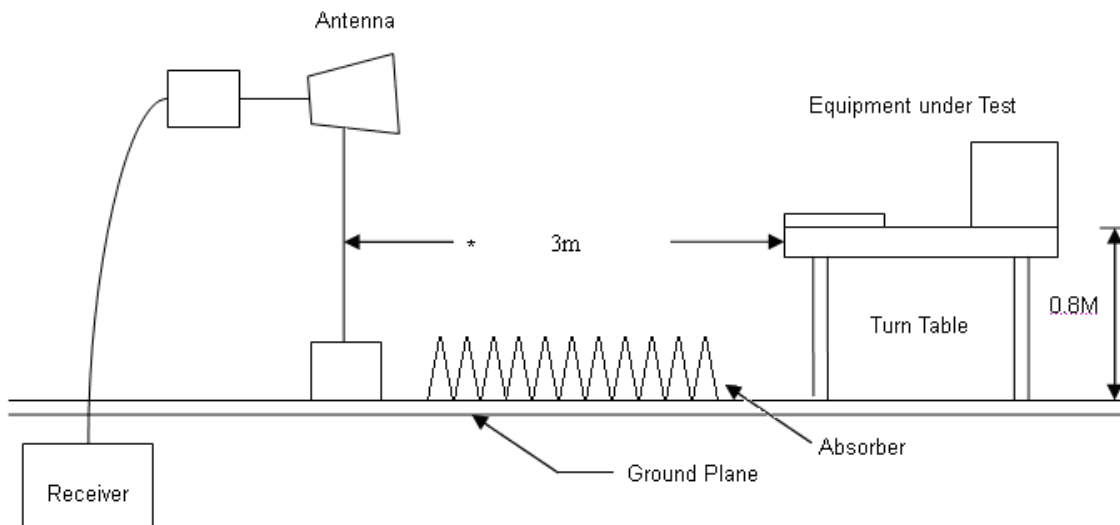



5.4. Measurement equipment

Instrument/Ancillary	Manufacturer	Model No.	Serial No.	Calibration Date	Valid Date.
EMI Test Receiver	R&S	ESCI	101183	2013.03.10	2014.03.09
Preamplifier	Agilent	87405B	My39500554	2013.03.10	2014.03.09
Preamplifier	Agilent	8449B	3008A02342	2013.03.10	2014.03.09
Ultra Broadband Antenna	R&S	HL562	100363	2013.05.02	2014.05.01
Broad-Band Horn Antenna	Schwarzbeck	BBHA9120D	9120D-618	2013.05.02	2014.05.01
Spectrum Analyzer	R&S	FSP40	100324	2013.03.10	2014.03.09
Temperature/ Humidity Meter	Zhicheng	ZC1-11	CEP-TH-001	2013.03.10	2014.03.09



5.5. Test Result and Data (30MHz ~ 1000MHz)

Test Mode :	Mode 1: Full System (VGA Mode 1920*1080@60Hz)		
AC Power :	AC 230V/50Hz	Ant. Polarization:	Horizontal
Equipment :	LCD Monitor	Model No :	230LM00024
Temp :	23°C	Humidity :	50%
Pressure(mbar) :	1002	Date :	2013/07/23

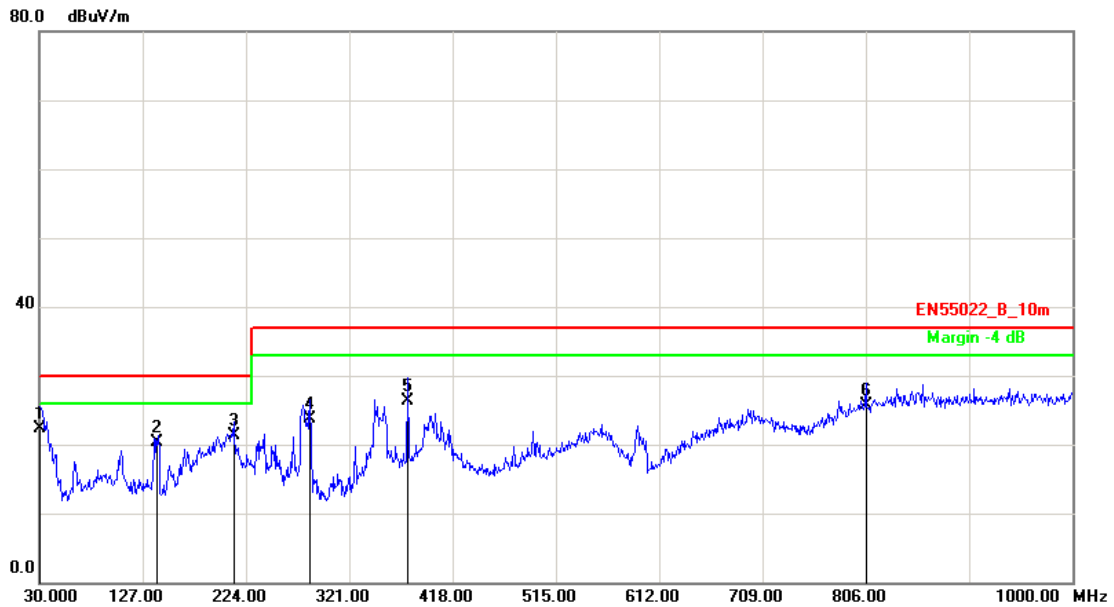

No.	Frequency (MHz)	Factor (dB/m)	Reading (dBuV)	Level (dBuV/m)	Limit (dBuV/m)	Margin (dB)	Det.	Height (cm)	Azimuth (deg)
1	31.2400	-0.18	22.51	22.33	30.00	-7.67	QP	100	359
2	140.9200	-13.40	33.71	20.31	30.00	-9.69	QP	400	343
3	212.6200	-14.36	35.60	21.24	30.00	-8.76	QP	400	199
4	284.6200	-12.78	36.40	23.62	37.00	-13.38	QP	250	340
5	376.2500	-6.97	33.22	26.25	37.00	-10.75	QP	250	337
6	806.1500	0.54	25.08	25.62	37.00	-11.38	QP	100	359

Note: Measurement Level = Reading Level + Correct Factor



Test Mode :	Mode 1: Full System (VGA Mode 1920*1080@60Hz)		
AC Power :	AC 230V/50Hz	Ant. Polarization:	Vertical
Equipment :	LCD Monitor	Model No :	230LM00024
Temp :	23°C	Humidity :	50%
Pressure(mbar) :	1002	Date :	2013/07/23

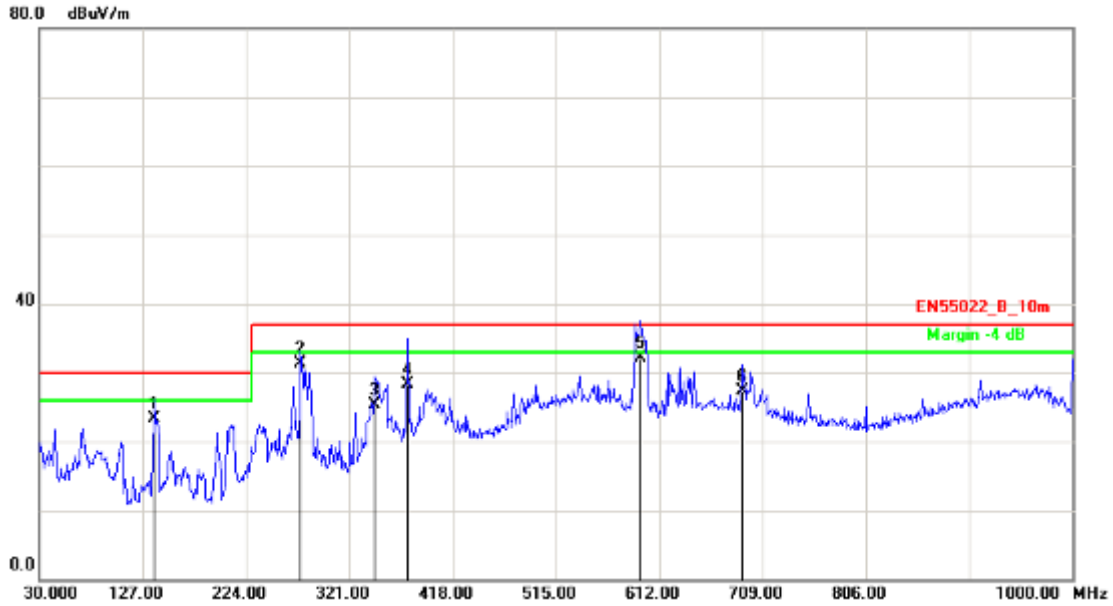

No.	Frequency (MHz)	Factor (dB/m)	Reading (dBuV)	Level (dBuV/m)	Limit (dBuV/m)	Margin (dB)	Det.	Height (cm)	Azimuth (deg)
1	137.6700	-16.11	39.36	23.25	30.00	-6.75	QP	100	147
2	275.4100	-11.01	42.26	31.25	37.00	-5.75	QP	100	1
3	345.2500	-6.75	32.07	25.32	37.00	-11.68	QP	100	266
4	376.2900	-3.99	32.31	28.32	37.00	-8.68	QP	400	17
5	594.0349	-0.72	32.84	32.12	37.00	-4.88	QP	244	0
6	690.5700	0.07	27.17	27.24	37.00	-9.76	QP	400	3

Note: Measurement Level = Reading Level + Correct Factor



Test Mode :	Mode 4: Full System (HDMI Mode 1920*1080@60Hz)		
AC Power :	AC 230V/50Hz	Ant. Polarization:	Horizontal
Equipment :	LCD Monitor	Model No :	230LM00024
Temp :	23°C	Humidity :	50%
Pressure(mbar) :	1002	Date :	2013/07/23

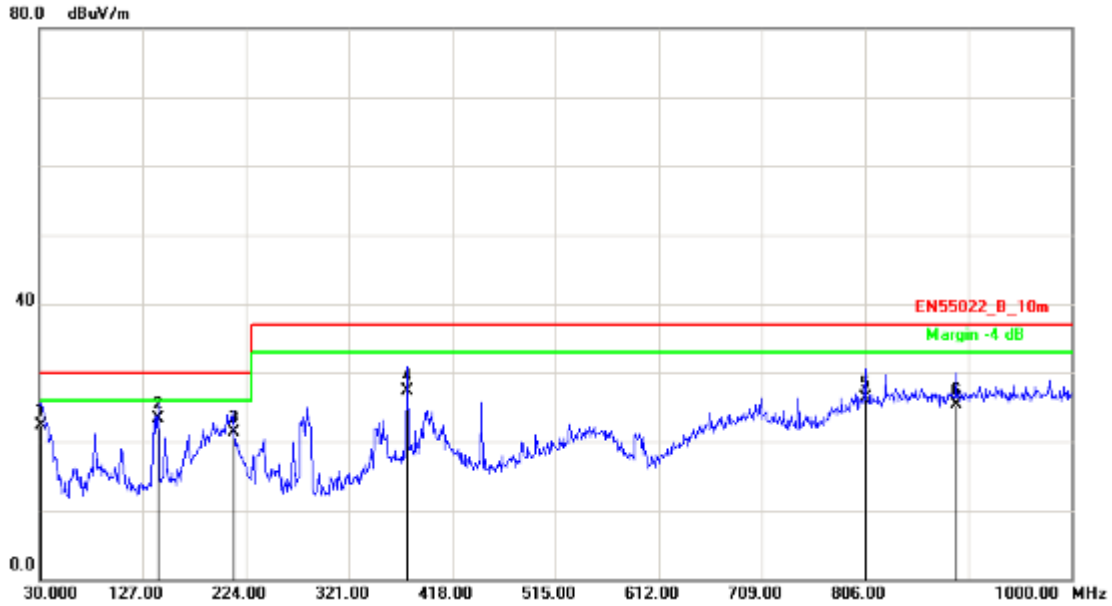

No.	Frequency (MHz)	Factor (dB/m)	Reading (dBuV)	Level (dBuV/m)	Limit (dBuV/m)	Margin (dB)	Det.	Height (cm)	Azimuth (deg)
1	32.2000	-0.73	22.98	22.25	30.00	-7.75	QP	250	264
2	142.1500	-13.47	36.71	23.24	30.00	-6.76	QP	400	175
3	212.6200	-14.36	35.61	21.25	30.00	-8.75	QP	274	0
4	376.3500	-6.97	34.29	27.32	37.00	-9.68	QP	250	352
5	806.1500	0.54	25.70	26.24	37.00	-10.76	QP	100	0
6	891.3600	1.52	23.80	25.32	37.00	-11.68	QP	100	12

Note: Measurement Level = Reading Level + Correct Factor



Test Mode :	Mode 4: Full System (HDMI Mode 1920*1080@60Hz)		
AC Power :	AC 230V/50Hz	Ant. Polarization:	Vertical
Equipment :	LCD Monitor	Model No :	230LM00024
Temp :	23°C	Humidity :	50%
Pressure(mbar) :	1002	Date :	2013/07/23

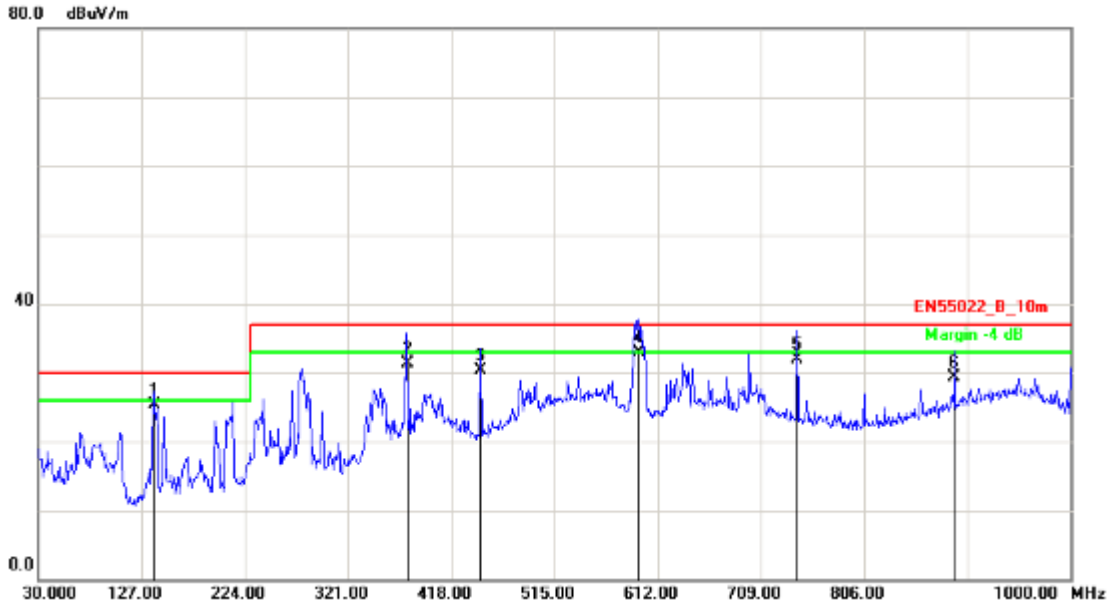

No.	Frequency (MHz)	Factor (dB/m)	Reading (dBuV)	Level (dBuV/m)	Limit (dBuV/m)	Margin (dB)	Det.	Height (cm)	Azimuth (deg)
1	138.8200	-16.17	41.50	25.33	30.00	-4.67	QP	100	199
2	376.6200	-3.96	35.21	31.25	37.00	-5.75	QP	400	74
3	445.2600	-3.12	33.37	30.25	37.00	-6.75	QP	100	338
4	595.1200	-0.78	33.67	32.89	37.00	-4.11	QP	225	360
5	743.2500	-1.54	33.36	31.82	37.00	-5.18	QP	400	16
6	890.2400	0.39	28.95	29.34	37.00	-7.66	QP	267	0

Note: Measurement Level = Reading Level + Correct Factor



Test Mode :	Mode 7: Full System (DVI Mode 1920*1080@60Hz)		
AC Power :	AC 230V/50Hz	Ant. Polarization:	Horizontal
Equipment :	LCD Monitor	Model No :	230LM00024
Temp :	23°C	Humidity :	50%
Pressure(mbar) :	1002	Date :	2013/07/23

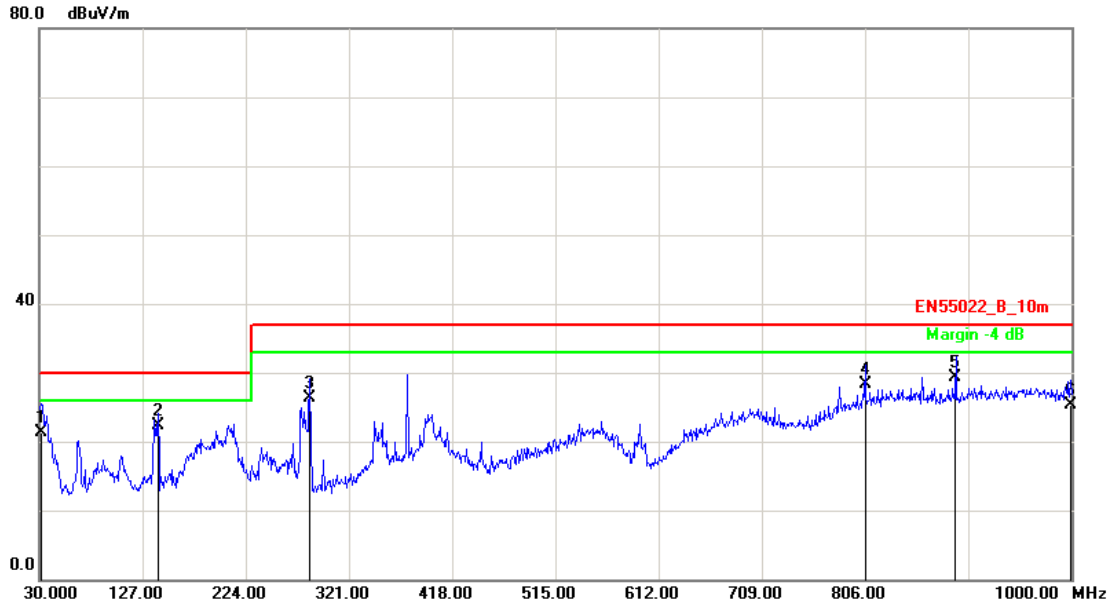

No.	Frequency (MHz)	Factor (dB/m)	Reading (dBuV)	Level (dBuV/m)	Limit (dBuV/m)	Margin (dB)	Det.	Height (cm)	Azimuth (deg)
1	32.2500	-0.76	22.08	21.32	30.00	-8.68	QP	400	10
2	142.2500	-13.48	35.73	22.25	30.00	-7.75	QP	400	2
3	284.2300	-12.78	39.10	26.32	37.00	-10.68	QP	250	47
4	806.3300	0.54	27.78	28.32	37.00	-8.68	QP	287	0
5	890.9200	1.52	27.80	29.32	37.00	-7.68	QP	100	38
6	999.2500	1.51	23.73	25.24	37.00	-11.76	QP	100	320

Note: Measurement Level = Reading Level + Correct Factor



Test Mode :	Mode 7: Full System (DVI Mode 1920*1080@60Hz)		
AC Power :	AC 230V/50Hz	Ant. Polarization:	Vertical
Equipment :	LCD Monitor	Model No :	230LM00024
Temp :	23°C	Humidity :	50%
Pressure(mbar) :	1002	Date :	2013/07/23

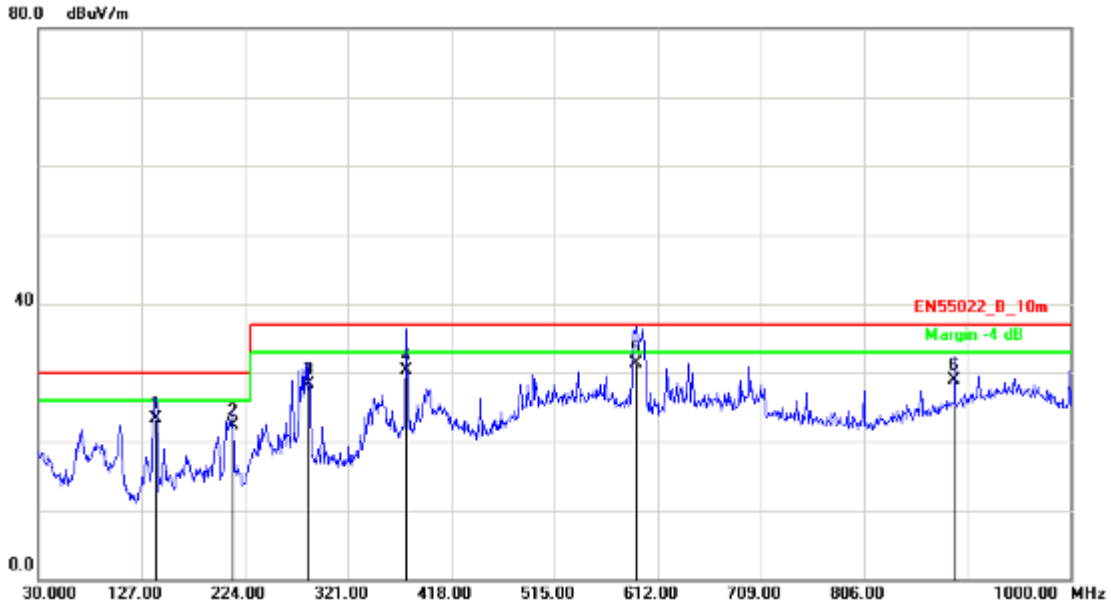

No.	Frequency (MHz)	Factor (dB/m)	Reading (dBuV)	Level (dBuV/m)	Limit (dBuV/m)	Margin (dB)	Det.	Height (cm)	Azimuth (deg)
1	140.5800	-16.26	39.50	23.24	30.00	-6.76	QP	100	167
2	213.3300	-18.88	41.09	22.21	30.00	-7.79	QP	100	359
3	284.5200	-10.53	38.86	28.33	37.00	-8.67	QP	400	124
4	376.3299	-3.99	34.27	30.28	37.00	-6.72	QP	400	59
5	592.1300	-0.61	31.86	31.25	37.00	-5.75	QP	250	3
6	891.2400	0.43	28.49	28.92	37.00	-8.08	QP	293	0

Note: Measurement Level = Reading Level + Correct Factor



5.6. Test Result and Data (1000MHz ~ 6000MHz)

Test Mode :	Mode 1: Full System (VGA Mode 1920*1080@60Hz)		
AC Power :	AC 230V/50Hz	Ant. Polarization:	Horizontal
Equipment :	LCD Monitor	Model No :	230LM00024
Temp :	23°C	Humidity :	50%
Pressure(mbar) :	1002	Date :	2013/07/23

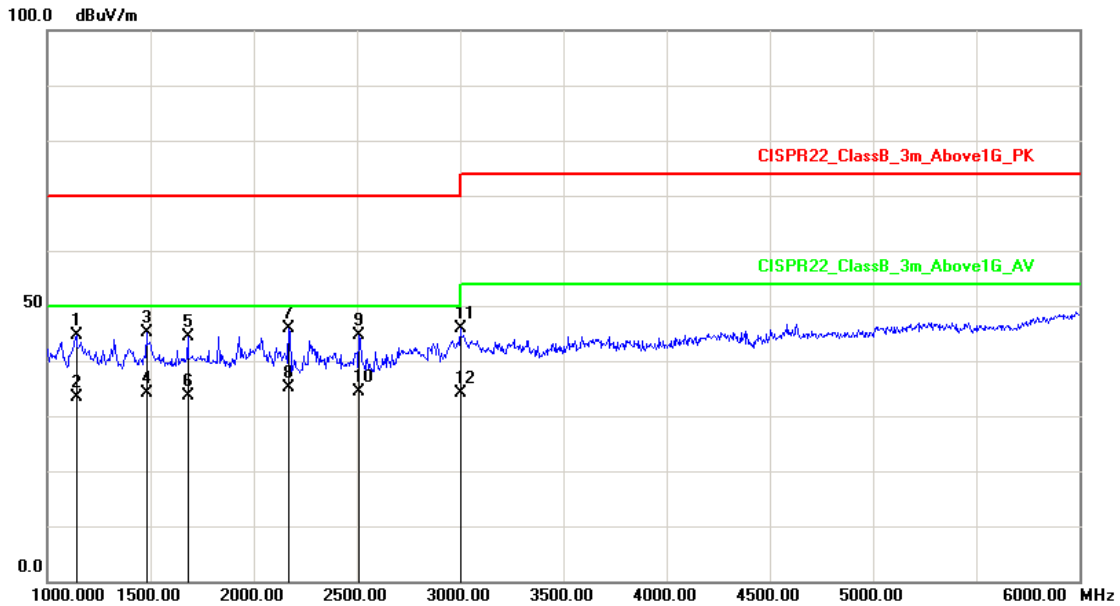

No.	Frequency (MHz)	Factor (dB/m)	Reading (dBuV)	Level (dBuV/m)	Limit (dBuV/m)	Margin (dB)	Det.	Height (cm)	Azimuth (deg)
1	1140.000	-13.42	58.05	44.63	70.00	-25.37	peak	100	19
2	1140.000	-13.42	46.68	33.26	50.00	-16.74	AVG	100	19
3	1480.000	-10.83	55.86	45.03	70.00	-24.97	peak	100	166
4	1480.000	-10.83	44.84	34.01	50.00	-15.99	AVG	100	166
5	1680.000	-10.44	54.79	44.35	70.00	-25.65	peak	100	2
6	1680.000	-10.44	44.03	33.59	50.00	-16.41	AVG	100	2
7	2170.000	-5.31	51.26	45.95	70.00	-24.05	peak	100	189
8	2170.000	-5.31	40.43	35.12	50.00	-14.88	AVG	100	189
9	2510.000	-3.70	48.30	44.60	70.00	-25.40	peak	100	0
10	2510.000	-3.70	37.98	34.28	50.00	-15.72	AVG	100	0
11	3000.000	-3.02	48.79	45.77	70.00	-24.23	peak	100	112
12	3000.000	-3.02	37.22	34.20	50.00	-15.80	AVG	100	112

Note: Measurement Level = Reading Level + Correct Factor



Test Mode :	Mode 1: Full System (VGA Mode 1920*1080@60Hz)		
AC Power :	AC 230V/50Hz	Ant. Polarization:	Vertical
Equipment :	LCD Monitor	Model No :	230LM00024
Temp :	23°C	Humidity :	50%
Pressure(mbar) :	1002	Date :	2013/07/23

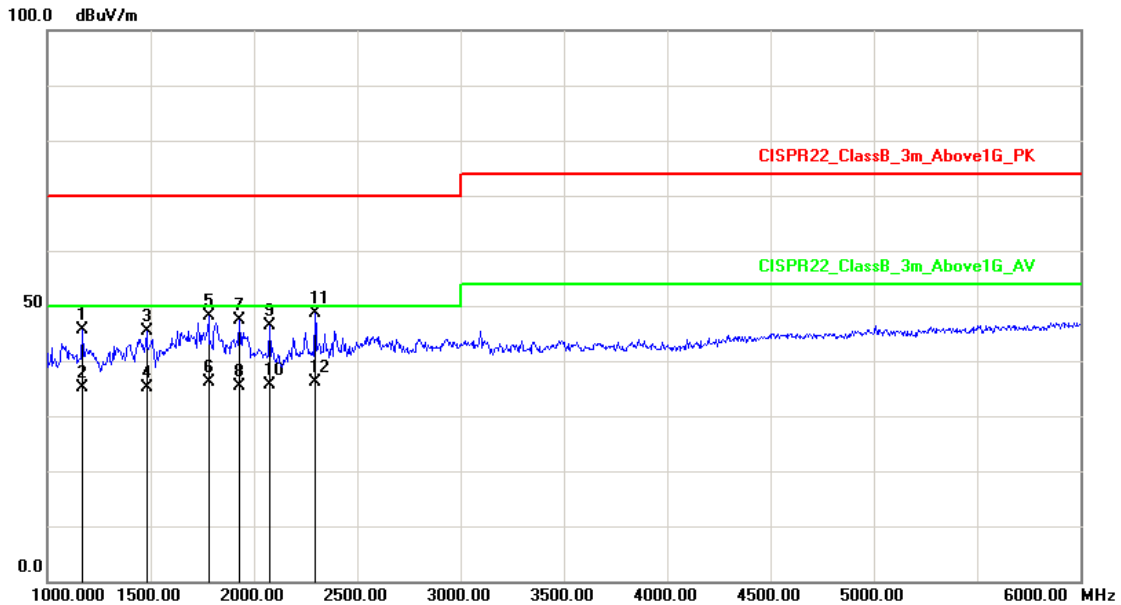

No.	Frequency (MHz)	Factor (dB/m)	Reading (dBuV)	Level (dBuV/m)	Limit (dBuV/m)	Margin (dB)	Det.	Height (cm)	Azimuth (deg)
1	1170.000	-13.25	58.78	45.53	70.00	-24.47	peak	100	0
2	1170.000	-13.25	48.36	35.11	50.00	-14.89	AVG	100	0
3	1480.000	-10.83	56.31	45.48	70.00	-24.52	peak	100	163
4	1480.000	-10.83	45.85	35.02	50.00	-14.98	AVG	100	163
5	1780.000	-10.93	59.00	48.07	70.00	-21.93	peak	100	29
6	1780.000	-10.93	47.07	36.14	50.00	-13.86	AVG	100	29
7	1930.000	-7.84	55.20	47.36	70.00	-22.64	peak	100	184
8	1930.000	-7.84	43.32	35.48	50.00	-14.52	AVG	100	184
9	2075.000	-5.77	52.05	46.28	70.00	-23.72	peak	100	221
10	2075.000	-5.77	41.39	35.62	50.00	-14.38	AVG	100	221
11	2295.000	-4.70	53.22	48.52	70.00	-21.48	peak	100	360
12	2295.000	-4.70	40.73	36.03	50.00	-13.97	AVG	100	360

Note: Measurement Level = Reading Level + Correct Factor



Test Mode :	Mode 4: Full System (HDMI Mode 1920*1080@60Hz)		
AC Power :	AC 230V/50Hz	Ant. Polarization:	Horizontal
Equipment :	LCD Monitor	Model No :	230LM00024
Temp :	23°C	Humidity :	50%
Pressure(mbar) :	1002	Date :	2013/07/23

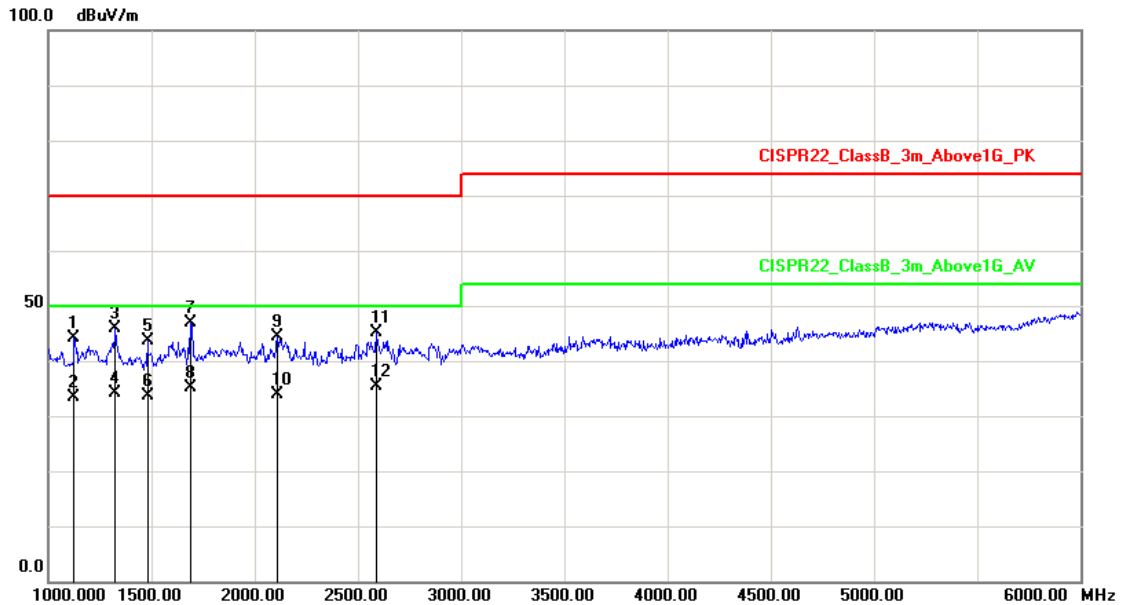

No.	Frequency (MHz)	Factor (dB/m)	Reading (dBuV)	Level (dBuV/m)	Limit (dBuV/m)	Margin (dB)	Det.	Height (cm)	Azimuth (deg)
1	1125.000	-13.51	57.58	44.07	70.00	-25.93	peak	100	2
2	1125.000	-13.51	46.81	33.30	50.00	-16.70	AVG	100	2
3	1325.000	-11.99	57.84	45.85	70.00	-24.15	peak	100	185
4	1325.000	-11.99	46.11	34.12	50.00	-15.88	AVG	100	185
5	1480.000	-10.83	54.36	43.53	70.00	-26.47	peak	100	36
6	1480.000	-10.83	44.41	33.58	50.00	-16.42	AVG	100	36
7	1690.000	-10.49	57.47	46.98	70.00	-23.02	peak	100	117
8	1690.000	-10.49	45.73	35.24	50.00	-14.76	AVG	100	117
9	2110.000	-5.60	49.87	44.27	70.00	-25.73	peak	100	0
10	2110.000	-5.60	39.51	33.91	50.00	-16.09	AVG	100	0
11	2590.000	-3.59	48.77	45.18	70.00	-24.82	peak	100	315
12	2590.000	-3.59	38.96	35.37	50.00	-14.63	AVG	100	315

Note: Measurement Level = Reading Level + Correct Factor



Test Mode :	Mode 4: Full System (HDMI Mode 1920*1080@60Hz)		
AC Power :	AC 230V/50Hz	Ant. Polarization:	Vertical
Equipment :	LCD Monitor	Model No :	230LM00024
Temp :	23°C	Humidity :	50%
Pressure(mbar) :	1002	Date :	2013/07/23

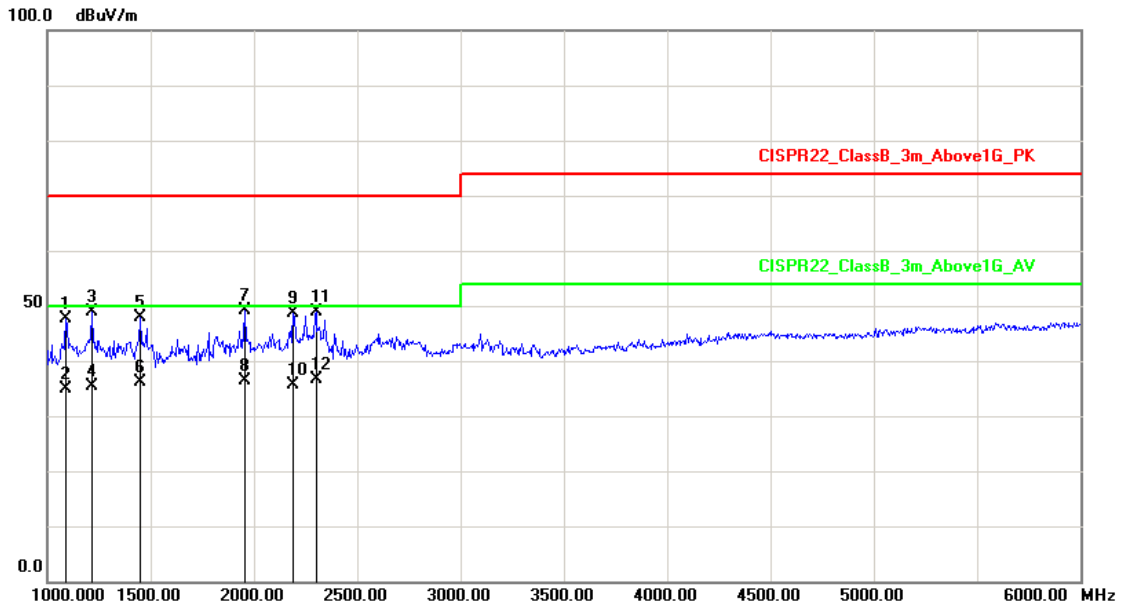

No.	Frequency (MHz)	Factor (dB/m)	Reading (dBuV)	Level (dBuV/m)	Limit (dBuV/m)	Margin (dB)	Det.	Height (cm)	Azimuth (deg)
1	1090.000	-13.71	61.37	47.66	70.00	-22.34	peak	100	15
2	1090.000	-13.71	48.67	34.96	50.00	-15.04	AVG	100	15
3	1215.000	-12.94	61.82	48.88	70.00	-21.12	peak	100	302
4	1215.000	-12.94	48.32	35.38	50.00	-14.62	AVG	100	302
5	1450.000	-11.02	58.94	47.92	70.00	-22.08	peak	100	114
6	1450.000	-11.02	47.03	36.01	50.00	-13.99	AVG	100	114
7	1955.000	-7.23	56.36	49.13	70.00	-20.87	peak	100	79
8	1955.000	-7.23	43.55	36.32	50.00	-13.68	AVG	100	79
9	2190.000	-5.21	53.86	48.65	70.00	-21.35	peak	100	201
10	2190.000	-5.21	40.91	35.70	50.00	-14.30	AVG	100	201
11	2300.000	-4.68	53.54	48.86	70.00	-21.14	peak	100	360
12	2300.000	-4.68	41.21	36.53	50.00	-13.47	AVG	100	360

Note: Measurement Level = Reading Level + Correct Factor



Test Mode :	Mode 7: Full System (DVI Mode 1920*1080@60Hz)		
AC Power :	AC 230V/50Hz	Ant. Polarization:	Horizontal
Equipment :	LCD Monitor	Model No :	230LM00024
Temp :	23°C	Humidity :	50%
Pressure(mbar) :	1002	Date :	2013/07/23

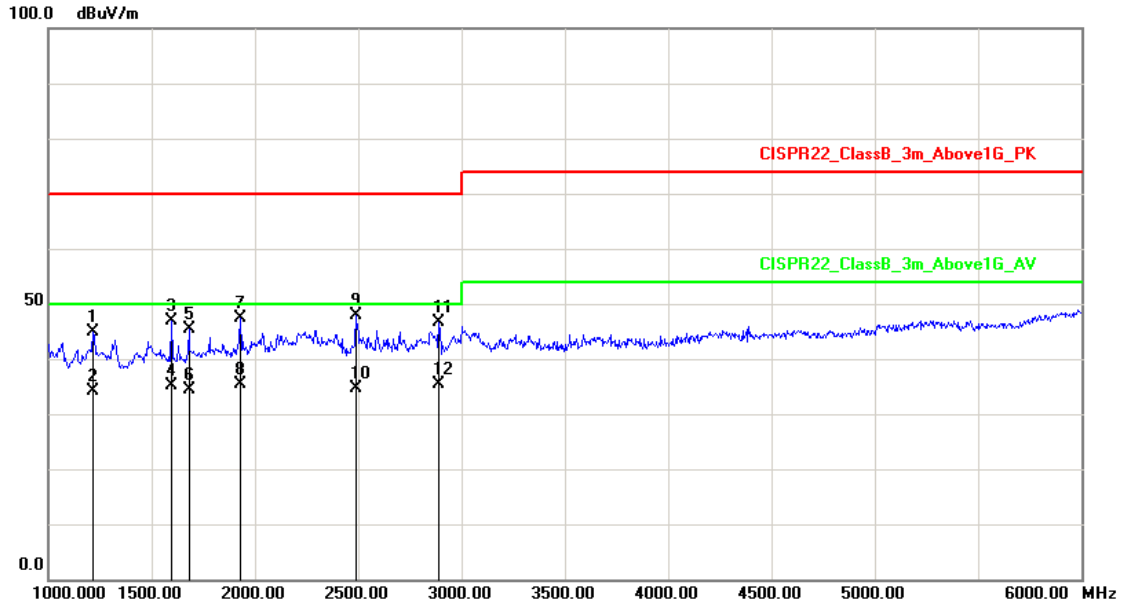

No.	Frequency (MHz)	Factor (dB/m)	Reading (dBuV)	Level (dBuV/m)	Limit (dBuV/m)	Margin (dB)	Det.	Height (cm)	Azimuth (deg)
1	1215.000	-12.94	57.90	44.96	70.00	-25.04	peak	100	124
2	1215.000	-12.94	46.95	34.01	50.00	-15.99	AVG	100	124
3	1595.000	-10.07	57.05	46.98	70.00	-23.02	peak	100	0
4	1595.000	-10.07	45.29	35.22	50.00	-14.78	AVG	100	0
5	1680.000	-10.44	55.79	45.35	70.00	-24.65	peak	100	345
6	1680.000	-10.44	44.82	34.38	50.00	-15.62	AVG	100	345
7	1930.000	-7.84	55.11	47.27	70.00	-22.73	peak	100	298
8	1930.000	-7.84	43.34	35.50	50.00	-14.50	AVG	100	298
9	2490.000	-3.76	51.68	47.92	70.00	-22.08	peak	100	15
10	2490.000	-3.76	38.37	34.61	50.00	-15.39	AVG	100	15
11	2890.000	-3.17	49.70	46.53	70.00	-23.47	peak	100	3
12	2890.000	-3.17	38.46	35.29	50.00	-14.71	AVG	100	3

Note: Measurement Level = Reading Level + Correct Factor



Test Mode :	Mode 7: Full System (DVI Mode 1920*1080@60Hz)		
AC Power :	AC 230V/50Hz	Ant. Polarization:	Vertical
Equipment :	LCD Monitor	Model No :	230LM00024
Temp :	23℃	Humidity :	50%
Pressure(mbar) :	1002	Date :	2013/07/23

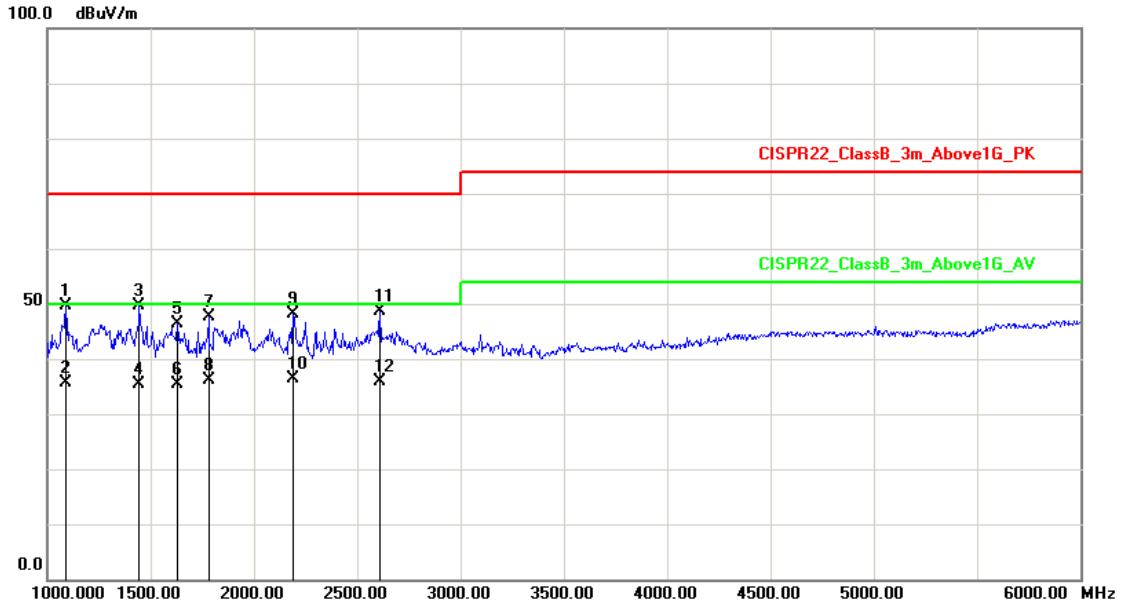

No.	Frequency (MHz)	Factor (dB/m)	Reading (dBuV)	Level (dBuV/m)	Limit (dBuV/m)	Margin (dB)	Det.	Height (cm)	Azimuth (deg)
1	1090.000	-13.71	63.37	49.66	70.00	-20.34	peak	100	26
2	1090.000	-13.71	49.33	35.62	50.00	-14.38	AVG	100	26
3	1445.000	-11.06	60.58	49.52	70.00	-20.48	peak	100	87
4	1445.000	-11.06	46.36	35.30	50.00	-14.70	AVG	100	87
5	1630.000	-10.19	56.66	46.47	70.00	-23.53	peak	100	119
6	1630.000	-10.19	45.66	35.47	50.00	-14.53	AVG	100	119
7	1780.000	-10.93	58.50	47.57	70.00	-22.43	peak	100	1
8	1780.000	-10.93	47.04	36.11	50.00	-13.89	AVG	100	1
9	2190.000	-5.21	53.36	48.15	70.00	-21.85	peak	100	281
10	2190.000	-5.21	41.51	36.30	50.00	-13.70	AVG	100	281
11	2610.000	-3.56	52.28	48.72	70.00	-21.28	peak	100	163
12	2610.000	-3.56	39.35	35.79	50.00	-14.21	AVG	100	163

Note: Measurement Level = Reading Level + Correct Factor

Test engineer: Seben



5.7. Test Photographs (30MHz ~ 1000MHz)

Front View



Rear View

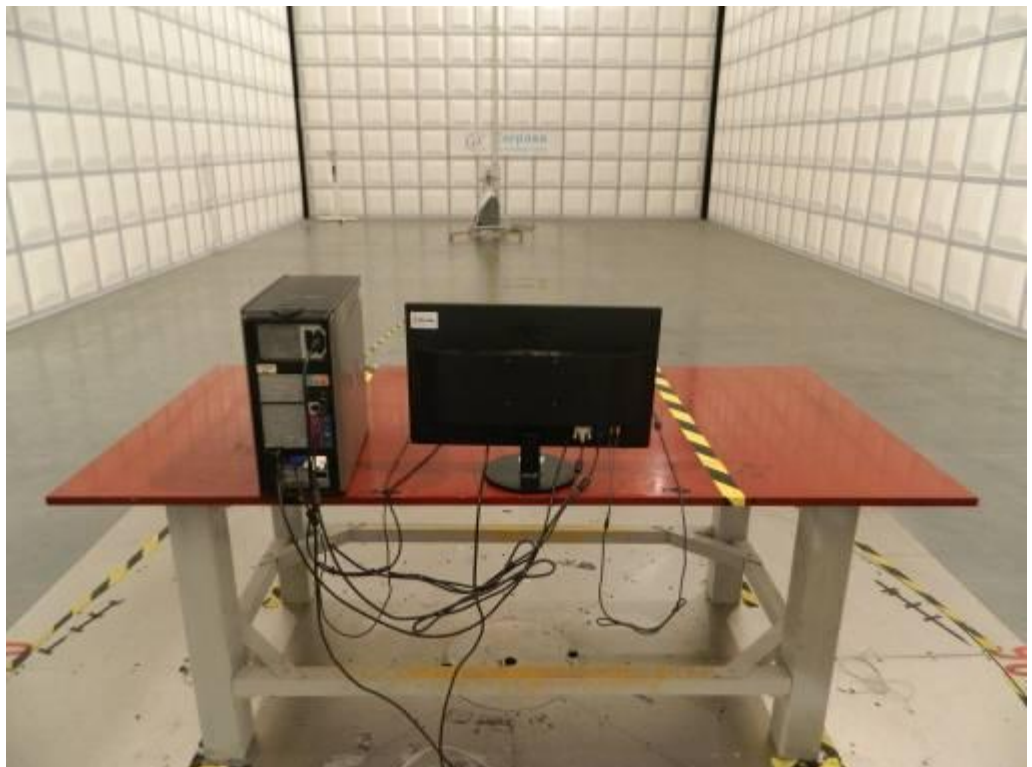



5.8. Test Photographs (1000MHz ~ 6000MHz)

Front View



Rear View

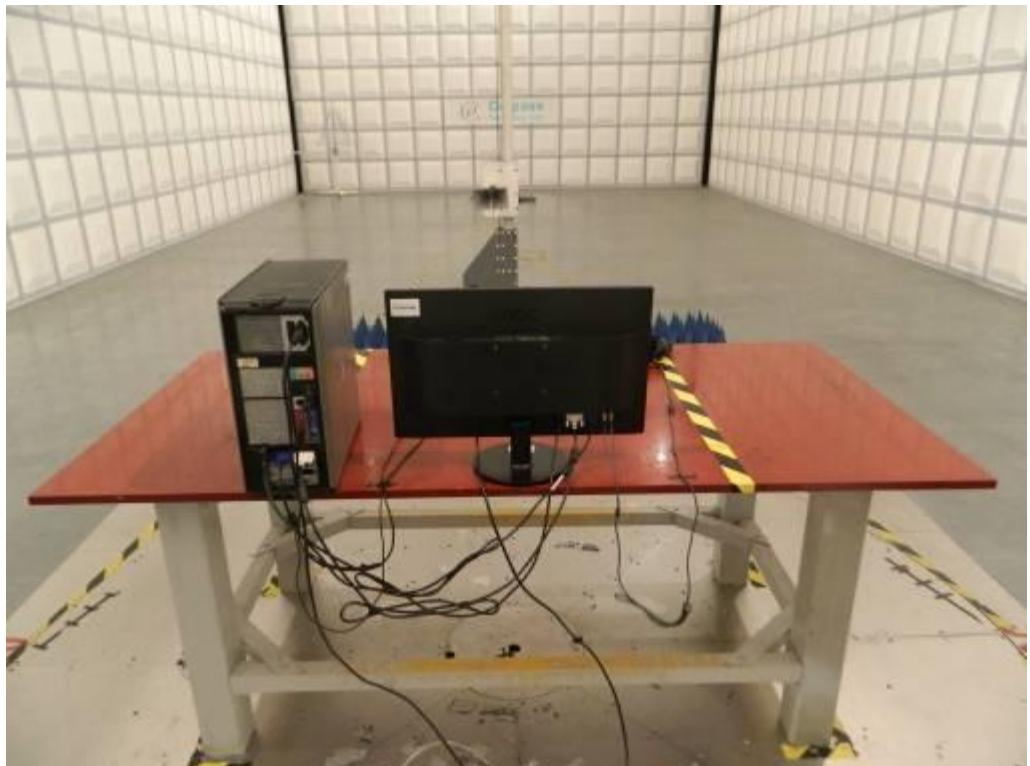



6. Harmonics Test

6.1. Limits Of Harmonics Current Measurement

Limits for Class A equipment		Limits for Class D equipment		
Harmonics Order n	Max. Permissible harmonics current A	Harmonics Order n	Max. Permissible harmonics current per watt mA/W	Max. Permissible harmonics current A
Odd harmonics		Odd Harmonics only		
3	2.30	3	3.4	2.30
5	1.14	5	1.9	1.14
7	0.77	7	1.0	0.77
9	0.40	9	0.5	0.40
11	0.33	11	0.35	0.33
13	0.21	13	0.30	0.21
15<=n<=39	0.15 × 15/n	15<=n<=39	3.85/n	0.15 x15/n
Even harmonics				
2	1.08			
4	0.43			
6	0.30			
8<=n<=40	0.23 × 8/n			

6.2. Measurement equipment

Instrument/Ancillary	Manufacturer	Model No.	Serial No.	Calibration Date	Valid Date.
EMC Emission Tester	EMCPARTNER	Harmonics-1000	159	2013.03.10	2014.03.09
Temperature/Humidity Meter	Zhicheng	ZC1-11	CEP-TH-004	2013.03.10	2014.03.09



6.3. Test Result and Data

Basic Standard	:	EN 61000-3-2
Final Test Result	:	PASS
Test Mode	:	Mode 1
Model No.	:	230LM00024
Temperature	:	20°C
Humidity	:	50 %
Atmospheric Pressure	:	100 kPa
Test Date	:	Jul 22, 2013

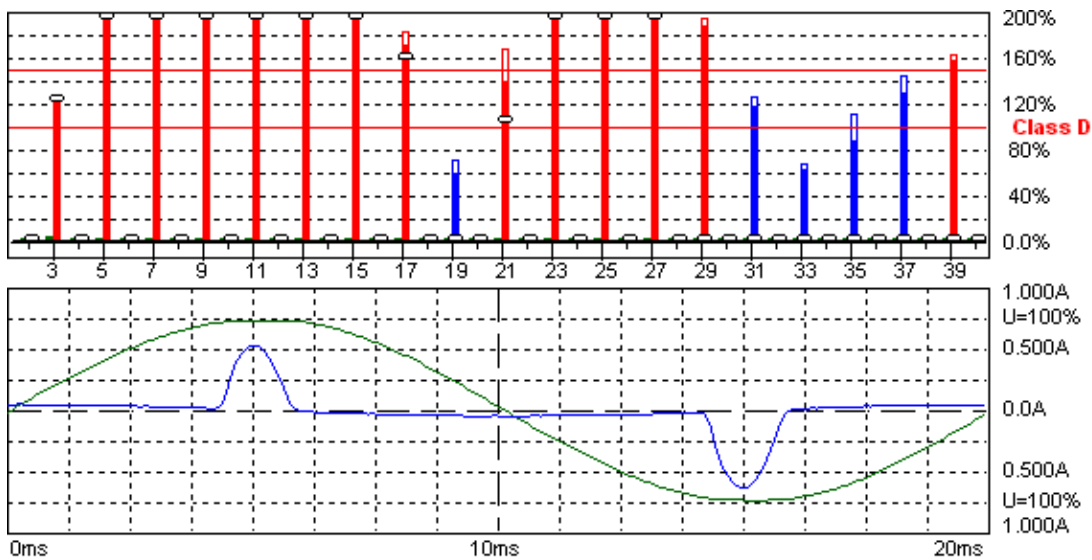

Harmonic Emission - IEC 61000-3-2, EN 61000-3-2, (EN60555-2)

2013-7-22 16:03:28 harmonic.hsu

Urms = 229.7 V P = 18.97 W THC = 0.146 A Range: 1 A
 Irms = 0.169 A pf = 0.487 Pmax = 19.39 W V-nom: 230 V
 TestTime: 15 min (100%)

Test completed, Result: FAILED

MODE 1

HAR-1000 EMC-Partner

Full Bar : Actual Values
 Empty Bar : Maximum Values
 Blue : Current , Green : Voltage , Red : Failed

Urms = 229.7V Freq = 50.000 Range: 1 A
 Irms = 0.169A Ipk = 0.637A cf = 3.758
 P = 18.97W S = 38.92VA pf = 0.487
 THDi = 85.1 % THDu = 1.10 % Class D
 Test - Time : 15min (100 %)
 Limit Reference: Pmax = 19.391W
 Test completed, Result: N/L



Order	Freq. [Hz]	Irms [A]	Irms%L [%]	Imax [A]	Imax%L [%]	Limit [A]	Status
1	50	0.0905		0.0922			
2	100	0.0112		0.0114			
3	150	0.0798	121.00	0.0815	123.59	0.00	N/L
4	200	0.0100		0.0101			
5	250	0.0722	195.98	0.0735	199.46	0.00	N/L
6	300	0.0084		0.0085			
7	350	0.0629	324.51	0.0637	328.61	0.00	N/L
8	400	0.0063		0.0063			
9	450	0.0516	531.94	0.0519	535.09	0.00	N/L
10	500	0.0042		0.0042			
11	550	0.0392	578.25	0.0397	584.55	0.00	N/L
12	600	0.0024		0.0025			
13	650	0.0273	476.14	0.0278	484.64	0.00	N/L
14	700	0.0020		0.0021			
15	750	0.0162	324.98	0.0167	334.79	0.00	N/L
16	800	0.0024		0.0026			
17	850	0.0074	169.56	0.0079	180.68	0.00	N/L
18	900	0.0029		0.0029			
19	950	0.0022	55.921	0.0027	68.347	0.00	N/L
20	1000	0.0029		0.0030			
21	1050	0.0049	137.35	0.0059	164.82	0.00	N/L
22	1100	0.0026		0.0026			
23	1150	0.0071	220.00	0.0076	235.05	0.00	N/L
24	1200	0.0020		0.0021			
25	1250	0.0075	251.40	0.0077	257.53	0.00	N/L
26	1300	0.0016		0.0016			
27	1350	0.0066	238.40	0.0067	242.81	0.00	N/L
28	1400	0.0016		0.0016			
29	1450	0.0048	184.93	0.0049	192.04	0.00	N/L
30	1500	0.0018		0.0020			
31	1550	0.0027	114.05	0.0029	121.65	0.00	N/L
32	1600	0.0021		0.0022			
33	1650	0.0013	59.354	0.0015	64.750	0.00	N/L
34	1700	0.0021		0.0021			
35	1750	0.0018	85.843	0.0023	108.73	0.00	N/L
36	1800	0.0019		0.0020			
37	1850	0.0026	127.05	0.0029	142.17	0.00	N/L
38	1900	0.0015		0.0016			
39	1950	0.0029	153.05	0.0031	159.42	0.00	N/L
40	2000	0.0012		0.0013			

The power of EUT is less than 75W after the testing. According the standard, the equipment with a rated power of 75W or less, other than lighting equipment, limits are not specified in this standard. So the test data needn't list.



Basic Standard	:	EN 61000-3-2
Final Test Result	:	PASS
Test Mode	:	Mode 4
Model No.	:	230LM00024
Temperature	:	20°C
Humidity	:	50 %
Atmospheric Pressure	:	100 kPa
Test Date	:	Jul 22, 2013

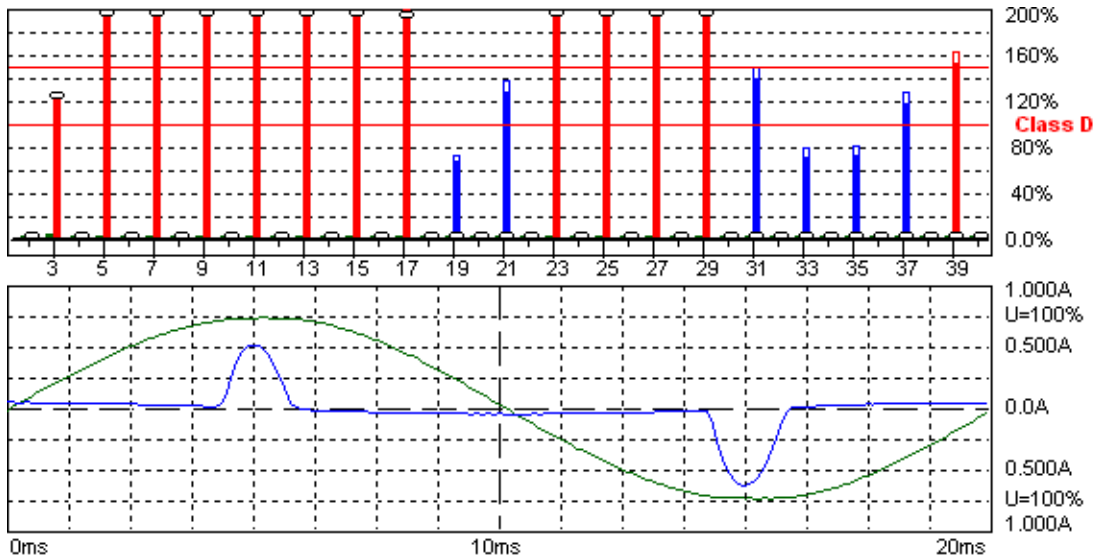

Harmonic Emission - IEC 61000-3-2 , EN 61000-3-2 , (EN60555-2)

2013-7-22 16:50:50 harmonic.hsu

Urms = 229.7 V P = 18.53 W THC = 0.145 A
 Irms = 0.167 A pf = 0.483 Pmax = 18.77 W

Range: 1 A
 V-nom: 230 V
 TestTime: 15 min (100%)

Test completed, Result: FAILED

MODE 4

HAR-1000 EMC-Parber

Full Bar : Actual Values
 Empty Bar : Maximum Values
 Blue : Current , Green : Voltage , Red : Failed

Urms = 229.7V Freq = 50.000 Range: 1 A
 Irms = 0.167A Ipk = 0.634A cf = 3.795
 P = 18.53W S = 38.36VA pf = 0.483
 THDi = 85.3 % THDu = 1.00 % Class D
 Test - Time : 15min (100 %)
 Limit Reference: Pmax = 18.771W
 Test completed, Result: N/L



Order	Freq. [Hz]	I _{rms} [A]	I _{rms} %L [%]	I _{max} [A]	I _{max} %L [%]	Limit [A]	Status
1	50	0.0887		0.0887			
2	100	0.0114		0.0115			
3	150	0.0782	122.51	0.0782	122.60	0.00	N/L
4	200	0.0102		0.0103			
5	250	0.0710	199.20	0.0712	199.54	0.00	N/L
6	300	0.0085		0.0086			
7	350	0.0621	331.00	0.0624	332.30	0.00	N/L
8	400	0.0064		0.0065			
9	450	0.0511	544.95	0.0515	548.85	0.00	N/L
10	500	0.0043		0.0045			
11	550	0.0393	598.28	0.0398	605.71	0.00	N/L
12	600	0.0025		0.0027			
13	650	0.0278	500.65	0.0283	509.43	0.00	N/L
14	700	0.0019		0.0021			
15	750	0.0169	350.91	0.0175	362.31	0.00	N/L
16	800	0.0024		0.0026			
17	850	0.0083	195.26	0.0088	206.75	0.00	N/L
18	900	0.0029		0.0030			
19	950	0.0024	64.186	0.0027	70.604	0.00	N/L
20	1000	0.0031		0.0031			
21	1050	0.0043	124.15	0.0046	134.79	0.00	N/L
22	1100	0.0027		0.0028			
23	1150	0.0068	215.61	0.0070	223.38	0.00	N/L
24	1200	0.0021		0.0022			
25	1250	0.0074	257.59	0.0076	261.81	0.00	N/L
26	1300	0.0016		0.0017			
27	1350	0.0068	253.11	0.0069	257.67	0.00	N/L
28	1400	0.0015		0.0016			
29	1450	0.0051	203.28	0.0053	213.08	0.00	N/L
30	1500	0.0018		0.0019			
31	1550	0.0032	136.14	0.0034	146.61	0.00	N/L
32	1600	0.0022		0.0023			
33	1650	0.0015	69.675	0.0017	78.036	0.00	N/L
34	1700	0.0022		0.0023			
35	1750	0.0015	70.942	0.0016	79.810	0.00	N/L
36	1800	0.0021		0.0021			
37	1850	0.0023	115.62	0.0024	124.99	0.00	N/L
38	1900	0.0017		0.0018			
39	1950	0.0027	148.22	0.0029	158.10	0.00	N/L
40	2000	0.0013		0.0015			

The power of EUT is less than 75W after the testing. According the standard, the equipment with a rated power of 75W or less, other than lighting equipment, limits are not specified in this standard. So the test data needn't list.



Basic Standard	:	EN 61000-3-2
Final Test Result	:	PASS
Test Mode	:	Mode 7
Model No.	:	230LM00024
Temperature	:	20°C
Humidity	:	50 %
Atmospheric Pressure	:	100 kPa
Test Date	:	Jul 22, 2013

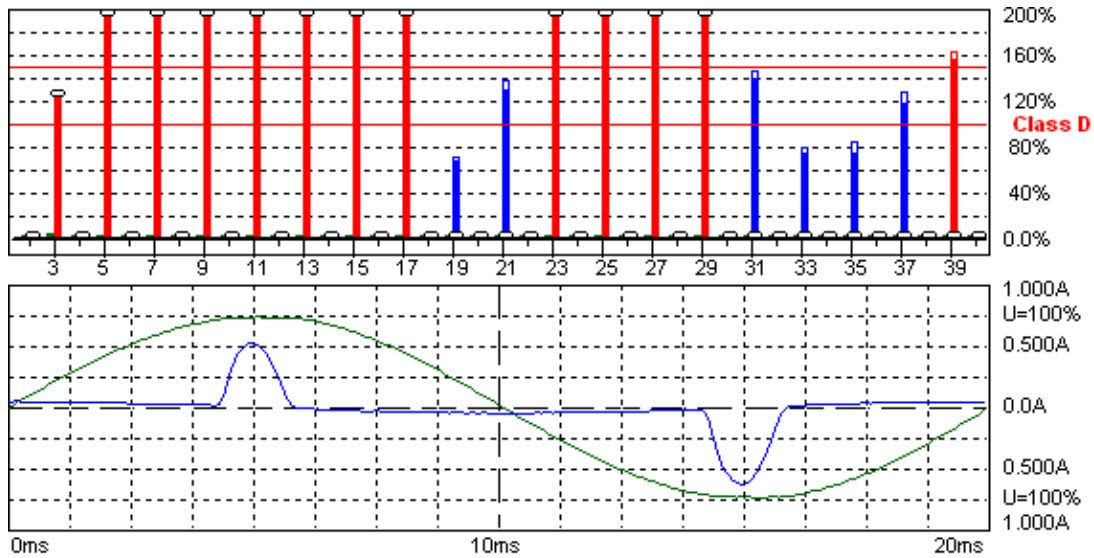

Harmonic Emission - IEC 61000-3-2 , EN 61000-3-2 , (EN60555-2)

2013-7-22 17:06:26 harmonic.hsu

Urms = 229.7 V	P = 18.55 W	THC = 0.145 A	Range: 1 A
Irms = 0.167 A	pf = 0.484	Pmax = 18.58 W	V-nom: 230 V
			TestTime: 15 min (100%)

Test completed, Result: FAILED

MODE 7

HAR-1000 EMC-Partner

Full Bar : Actual Values
 Empty Bar : Maximum Values
 Blue : Current , Green : Voltage , Red : Failed

Urms = 229.7V Freq = 49.987 Range: 1 A
 Irms = 0.167A Ipk = 0.636A cf = 3.807
 P = 18.55W S = 38.36VA pf = 0.484
 THDi = 85.3 % THDu = 1.00 % Class D
 Test - Time : 15min (100 %)
 Limit Reference: Pmax = 18.577W
 Test completed, Result: N/L



Order	Freq. [Hz]	Irms [A]	Irms%L [%]	Imax [A]	Imax%L [%]	Limit [A]	Status
1	50	0.0887		0.0888			
2	100	0.0115		0.0117			
3	150	0.0782	123.79	0.0783	123.98	0.00	N/L
4	200	0.0103		0.0104			
5	250	0.0710	201.28	0.0712	201.63	0.00	N/L
6	300	0.0086		0.0088			
7	350	0.0621	334.47	0.0623	335.45	0.00	N/L
8	400	0.0066		0.0067			
9	450	0.0511	550.65	0.0514	553.28	0.00	N/L
10	500	0.0045		0.0046			
11	550	0.0393	604.54	0.0397	610.17	0.00	N/L
12	600	0.0026		0.0027			
13	650	0.0278	505.89	0.0283	513.65	0.00	N/L
14	700	0.0020		0.0021			
15	750	0.0170	355.86	0.0175	366.10	0.00	N/L
16	800	0.0025		0.0026			
17	850	0.0083	197.30	0.0087	207.46	0.00	N/L
18	900	0.0029		0.0031			
19	950	0.0024	64.857	0.0026	69.721	0.00	N/L
20	1000	0.0031		0.0032			
21	1050	0.0043	127.24	0.0046	136.20	0.00	N/L
22	1100	0.0027		0.0028			
23	1150	0.0068	217.87	0.0070	225.72	0.00	N/L
24	1200	0.0021		0.0022			
25	1250	0.0074	260.28	0.0076	264.55	0.00	N/L
26	1300	0.0016		0.0017			
27	1350	0.0068	255.76	0.0069	260.37	0.00	N/L
28	1400	0.0016		0.0016			
29	1450	0.0051	207.88	0.0053	215.31	0.00	N/L
30	1500	0.0018		0.0019			
31	1550	0.0032	137.57	0.0034	145.50	0.00	N/L
32	1600	0.0022		0.0023			
33	1650	0.0016	73.220	0.0017	78.853	0.00	N/L
34	1700	0.0022		0.0023			
35	1750	0.0015	71.684	0.0016	80.645	0.00	N/L
36	1800	0.0021		0.0022			
37	1850	0.0023	116.83	0.0024	126.30	0.00	N/L
38	1900	0.0017		0.0018			
39	1950	0.0028	153.10	0.0029	159.75	0.00	N/L
40	2000	0.0013		0.0015			

he power of EUT is less than 75W after the testing. According the standard, the equipment with a rated power of 75W or less, other than lighting equipment, limits are not specified in this standard. So the test data needn't list.

Test engineer: 



6.4. Test Photographs





7. Voltage Fluctuations Test

7.1. Test Procedure

The equipment shall be tested under the conditions of **Clause 5**.

The total impedance of the test circuit, excluding the appliance under test, but including the internal impedance of the supply source, shall be equal to the reference impedance. The stability and tolerance of the reference impedance shall be adequate to ensure that the overall accuracy of $\pm 8\%$ is achieved during the whole assessment procedure.

7.2. Measurement equipment

Instrument/Ancillary	Manufacturer	Model No.	Serial No.	Calibration Date	Valid Date.
EMC Emission Tester	EMCPARTNER	Harmonics-1000	159	2013.03.10	2014.03.09
Temperature/ Humidity Meter	Zhicheng	ZC1-11	CEP-TH-004	2013.03.10	2014.03.09



7.3. Test Result and Data

Basic Standard	:	EN 61000-3-3
Final Test Result	:	PASS
Test Mode	:	Mode 1
Model No.	:	230LM00024
Temperature	:	20°C
Humidity	:	50 %
Atmospheric Pressure	:	100 kPa
Test Date	:	Jul 22, 2013

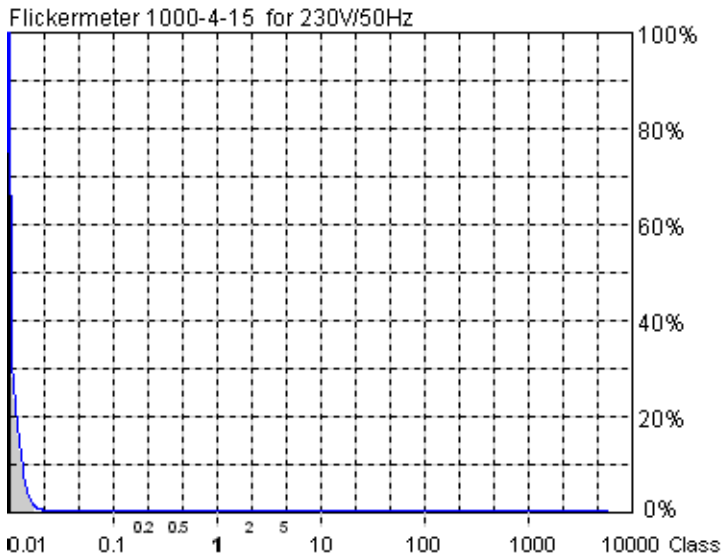

Actual Flicker (Fli): 0.02
Short-term Flicker (Pst): 0.08
 Limit (Pst): 1.00
Long-term Flicker (Plt): 0.08
 Limit (Plt): 0.65
Maximum Relative Volt. Change (dmax): 0.00%
 Limit (dmax): 4.00%
Relative Steady-state Voltage Change (dc): 0.11%
 Limit (dc): 3.30%
Maximum Interval exceeding 3.30% (dt): 0.00ms
 Limit (dt>Lim): 500ms

Flicker Emission - IEC 61000-3-3, EN 61000-3-3, (EN60555-3)

Urms = 229.7 V P = 18.58 W
 Irms = 0.167 A pf = 0.484

2013-7-22 16:23:08 harmonic.hsu

Range: 1 A
 V-nom: 230 V
 TestTime: 10 min (100%)

Test completed, Result: PASSED

MODE 1

HAR-1000 EMC-Partner

- Full Bar : Actual Values
- Empty Bar : Maximum Values
- Circles : Average Values
- Blue : Current , Green : Voltage , Red : Failed



Urms = 229.7V Freq = 50.000 Range: 1 A
Irms = 0.167A Ipk = 0.632A cf = 3.784
P = 18.58W S = 38.36VA pf = 0.484

Test - Time : 1 x 10min = 10min (100 %)

LIN (Line Impedance Network) : No LIN

Limits : Plt : 0.65 Pst : 1.00
dmax : 4.00 % dc : 3.30 %
dtLim: 3.30 % dt>Lim: 500ms

Test completed, Result: PASSED



Basic Standard	:	EN 61000-3-3
Final Test Result	:	PASS
Test Mode	:	Mode 4
Model No.	:	230LM00024
Temperature	:	20°C
Humidity	:	50 %
Atmospheric Pressure	:	100 kPa
Test Date	:	Jul 22, 2013

Flickermeter 1000-4-15 for 230V/50Hz

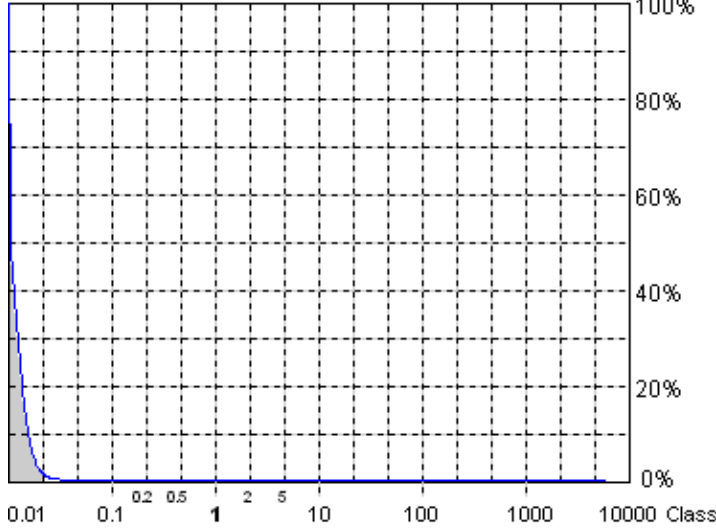

Actual Flicker (Fli): 0.01
Short-term Flicker (Pst): 0.09
 Limit (Pst): 1.00
Long-term Flicker (Plt): 0.09
 Limit (Plt): 0.65
Maximum Relative Volt. Change (dmax): 0.00%
 Limit (dmax): 4.00%
Relative Steady-state Voltage Change (dc): 0.10%
 Limit (dc): 3.30%
Maximum Interval exceeding 3.30% (dt): 0.00ms
 Limit (dt>Lim): 500ms

Flicker Emission - IEC 61000-3-3 , EN 61000-3-3 , (EN60555-3)

2013-7-22 16:34:20 harmonic.hsu

Urms = 229.7 V P = 18.53 W
 Irms = 0.167 A pf = 0.483

Range: 1 A
 V-nom: 230 V
 TestTime: 10 min (100%)

Test completed, Result: PASSED

MODE 4

HAR-1000 EMC-Parber

- Full Bar : Actual Values
- Empty Bar : Maximum Values
- Circles : Average Values
- Blue : Current , Green : Voltage , Red : Failed



Urms = 229.7V Freq = 49.987 Range: 1 A
Irms = 0.167A Ipk = 0.632A cf = 3.787
P = 18.53W S = 38.36VA pf = 0.483

Test - Time : 1 x 10min = 10min (100 %)

LIN (Line Impedance Network) : No LIN

Limits : Plt : 0.65 Pst : 1.00
dmax : 4.00 % dc : 3.30 %
dtLim: 3.30 % dt>Lim: 500ms

Test completed, Result: PASSED



Basic Standard	:	EN 61000-3-3
Final Test Result	:	PASS
Test Mode	:	Mode 7
Model No.	:	230LM00024
Temperature	:	20°C
Humidity	:	50 %
Atmospheric Pressure	:	100 kPa
Test Date	:	Jul 22, 2013

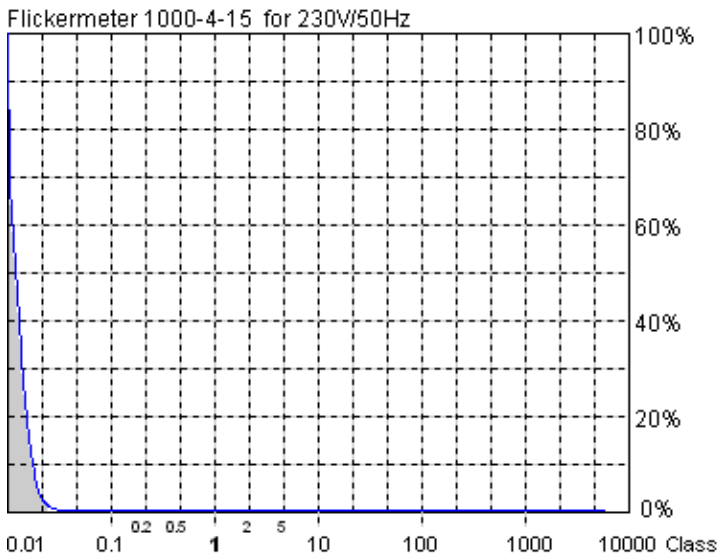

Actual Flicker (Fli): 0.02
Short-term Flicker (Pst): 0.10
 Limit (Pst): 1.00
Long-term Flicker (Plt): 0.10
 Limit (Plt): 0.65
Maximum Relative Volt. Change (dmax): 0.00%
 Limit (dmax): 4.00%
Relative Steady-state Voltage Change (dc): 0.15%
 Limit (dc): 3.30%
Maximum Interval exceeding 3.30% (dt): 0.00ms
 Limit (dt>Lim): 500ms

Flicker Emission - IEC 61000-3-3 , EN 61000-3-3 , (EN60555-3)

Urms = 229.7 V P = 18.58 W
 Irms = 0.167 A pf = 0.483

2013-7-22 17:18:32 harmonic.hsu

Range: 1 A
 V-nom: 230 V
 TestTime: 10 min (100%)

Test completed, Result: PASSED

MODE 7

HAR-1000 EMC-Parber

- Full Bar : Actual Values
- Empty Bar : Maximum Values
- Circles : Average Values
- Blue : Current , Green : Voltage , Red : Failed



Urms = 229.7V Freq = 50.000 Range: 1 A
Irms = 0.167A Ipk = 0.642A cf = 3.831
P = 18.58W S = 38.47VA pf = 0.483

Test - Time : 1 x 10min = 10min (100 %)

LIN (Line Impedance Network) : No LIN

Limits : Plt : 0.65 Pst : 1.00
dmax : 4.00 % dc : 3.30 %
dtLim: 3.30 % dt>Lim: 500ms

Test completed, Result: PASSED

Test engineer: _____



7.4. Test Photographs





8. Electrostatic Discharge Immunity Test

8.1. Test Procedure

- a. In the case of air discharge testing the climatic conditions shall be within the following ranges:
 - ambient temperature: 15°C to 35°C;
 - relative humidity : 30% to 60%;
 - atmospheric pressure : 86 KPa (860 hPa) to 106 KPa (1060 hPa).
- b. Test programs and software shall be chosen so as to exercise all normal modes of operation of the EUT. The use of special exercising software is encouraged, but permitted only where it can be shown that the EUT is being comprehensively exercised.
- c. The test voltage shall be increased from the minimum to the selected test severity level, in order to determine any threshold of failure. The final severity level should not exceed the product specification value in order to avoid damage to the equipment.
- d. The test shall be performed with both air discharge and contact discharge. On reselected points at least 10 single discharges (in the most sensitive polarity) shall be applied on air discharge. On reselected points at least 25 single discharges (in the most sensitive polarity) shall be applied on contact discharge.
- e. For the time interval between successive single discharges an initial value of one second is recommended. Longer intervals may be necessary to determine whether a system failure has occurred.
- f. In the case of contact discharges, the tip of the discharge electrode shall touch the EUT before the discharge switch is operated.
- g. In the case of painted surface covering a conducting substrate, the following procedure shall be adopted :
 - ◇ If the coating is not declared to be an insulating coating by the equipment manufacturer, then the pointed tip of the generator shall penetrate the coating so as to make contact with the conducting substrate.
 - ◇ Coating declared as insulating by the manufacturer shall only be submitted to the air discharge.
 - ◇ The contact discharge test shall not be applied to such surfaces.
- h. In the case of air discharges, the round discharge tip of the discharge electrode shall be approached as fast as possible (without causing mechanical damage) to touch the EUT . After each discharge, the ESD generator (discharge electrode) shall be removed from the EUT. The generator is then retriggered for a new single discharge. This procedure shall be repeated until the discharges are completed. In the case of an air discharge test, the discharge switch, which is used for contact discharge, shall be closed.

8.2. Test Setup for Tests Performed in Laboratory

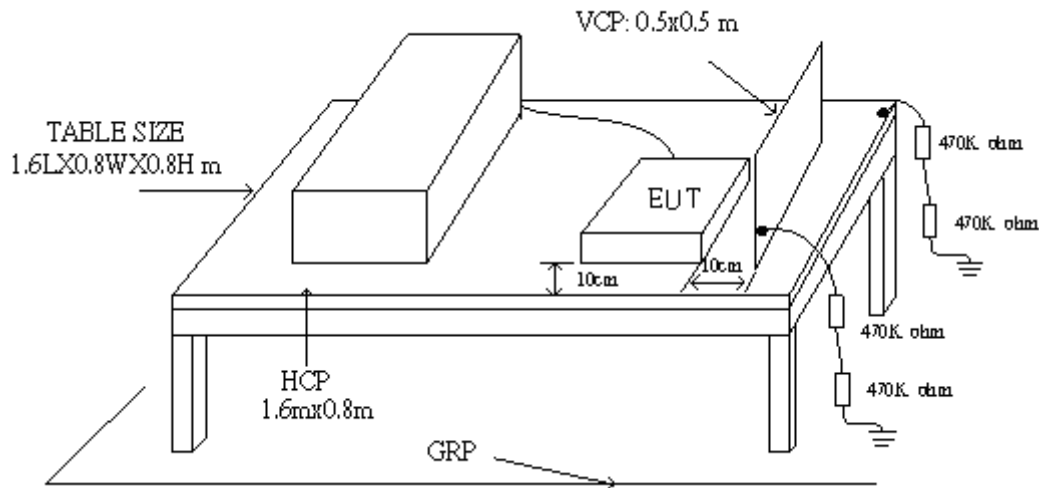

The test setup consists of the test generator, EUT and auxiliary instrumentation necessary to perform DIRECT and INDIRECT application of discharges to the EUT as applicable, in the follow manner :

- a. Contact Discharge to the conductive surfaces and to coupling plane;
- b. Air Discharge at insulating surfaces.

The preferred test method is that of type tests performed in laboratories and the only accepted method of demonstrating conformance with this standard. The EUT was arranged as closely as possible to arrangement in final installed conditions.

A ground reference plane was provided on the floor of the test site. It was a metallic sheet (copper or aluminum) of 0.25 mm, minimum thickness; other metallic may be used but they shall have at least 0.65 mm thickness. In the Exclusive Certification Corp., we provided 1 mm thickness stainless steel ground reference plane. The minimum size of the ground reference plane is 2.5 m x 2.5 m, the exact size depending on the dimensions of the EUT. It was connected to the protective grounding system.

The EUT was arranged and connected according to its functional requirements. A distance of 1m minimum was provided between the EUT and the wall of the lab. and any other metallic structure. In cases where this length exceeds the length necessary to apply the discharges to the selected points, the excess length shall, where possible, be placed non-inductively off the ground reference plane and shall not come closer than 0.2m to other conductive parts in the test setup.

Where the EUT is installed on a metal table, the table was connected to the reference plane via a cable with a 470k ohm resistor located at each end, to prevent a build-up of charge. The test setup



was consist a wooden table, 0.8m high, standing on the ground reference plane. A HCP, 1.6 m x 0.8 m, was placed on the table. The EUT and cables was isolated from the HCP by an insulating support 0.5 mm thick. The VCP size, 0.5 m x 0.5 m.

8.3. Test Severity Levels

Contact Discharge		Air Discharge	
Level	Test Voltage (kV) of Contact discharge	Level	Test Voltage (kV) of Air Discharge
1	±2	1	±2
2	±4	2	±4
3	±6	3	±8
4	±8	4	±15
X	Specified	X	Specified

Remark: "X" is an open level.

8.4. Measurement equipment

Instrument/Ancillary	Manufacturer	Model No.	Serial No.	Calibration Date	Valid Date.
ESD Simulator	EM Test	ditto	V0714102399	2013.03.26	2014.03.25
ESD Simulator	EMC PARTNER	ESD3000	292	2013.02.01	2014.01.31
Tonometer	shanghaifengyun	DYM3	3251	2013.03.22	2014.03.21
Dehumidifier	ZEDO	ZD-220LB	CEP-TH-01	N/A	N/A
Humidifier	YADU	YZ-DS251C	CEP-TH-02	N/A	N/A
Temperature/ Humidity Meter	feiyun	N/A	102	2013.03.10	2014.03.09



8.5. Test Result and Data

Basic Standard : IEC 61000-4-2
 Final Test Result : PASS
 Model No. : 230LM00024
 Test Voltage : ±2 / ±4 / ±8 kV for air discharge,
 : ±2 / ±4 kV for contact discharge
 Temperature : 20°C
 Relative Humidity : 50 %
 Atmospheric Pressure : 100 kPa
 Test Date : Jul 23, 2013

Test Mode : Mode 1& Mode 4& Mode 7

	Contact Discharge								Air Discharge							
	25 times / each								10 times / each							
Voltage	2 kV		4 kV		6 kV		8 kV		2 kV		4 kV		8 kV		10 kV	
Point\Polarity	+	-	+	-	+	-	+	-	+	-	+	-	+	-	+	-
HCP	A	A	A	A	---	---	---	---	---	---	---	---	---	---	---	---
VCP	A	A	A	A	---	---	---	---	---	---	---	---	---	---	---	---
Screw	A	A	A	A	---	---	---	---	---	---	---	---	---	---	---	---
Case	---	---	---	---	---	---	---	---	A	A	A	A	A	A	---	---
Panel	---	---	---	---	---	---	---	---	A	A	A	A	A	A	---	---
VGA Port	A	A	A	A	---	---	---	---	---	---	---	---	---	---	---	---
DVI Port	A	A	A	A	---	---	---	---	---	---	---	---	---	---	---	---
HDMI Port	A	A	A	A	---	---	---	---	---	---	---	---	---	---	---	---
Button	---	---	---	---	---	---	---	---	A	A	A	A	A	A	---	---
LED Light	---	---	---	---	---	---	---	---	A	A	A	A	A	A	---	---
Audio Port	---	---	---	---	---	---	---	---	A	A	A	A	A	A	---	---
Power Port	---	---	---	---	---	---	---	---	A	A	A	A	A	A	---	---

Test engineer: Seben



8.6. Test Photographs

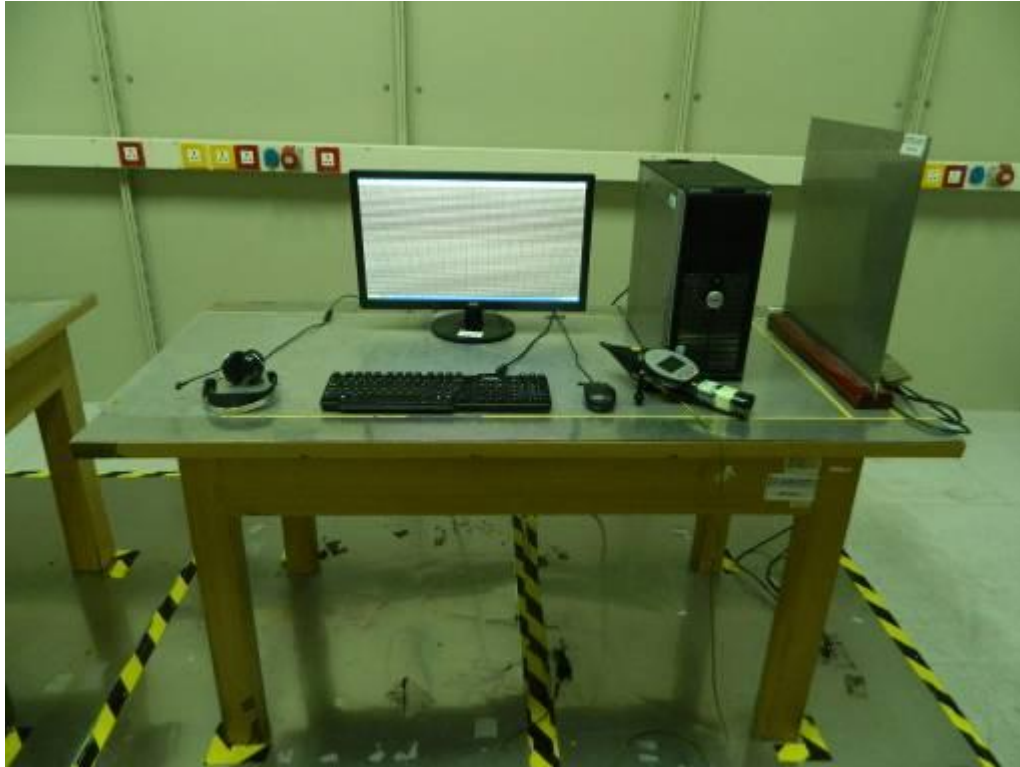



9. Radio Frequency electromagnetic field immunity test

9.1. Test Procedure

- a. The equipment to be tested is placed in the center of the enclosure on a wooden table. The equipment is then connected to power and signal leads according to pertinent installation instructions.
- b. The antenna which is enabling the complete frequency range of 80-1000 MHz is placed 3m away from the equipment. The required field strength is determined by placing the field strength meter(s) on top of or directly alongside the equipment under test and monitoring the field strength meter via a remote field strength indicator outside the enclosure while adjusting the continuous-wave to the applicable antennae.
- c. The test is normally performed with the antenna facing the most sensitive side of the EUT. The polarization of the field generated by the bucolical antenna necessitates testing each position twice, once with the antenna positioned vertically and again with the antenna positioned horizontally. The circular polarization of the field from the log-spiral antenna makes a change of position of the antenna unnecessary.
- d. At each of the above conditions, the frequency range is swept 80-1000 MHz, pausing to adjust the R.F. signal level or to switch oscillators and antenna. The rate of sweep is in the order of 1.5×10^{-3} decades/s. The sensitive frequencies or frequencies of dominant interest may be discretely analyzed.



9.2. Test Severity Levels

Frequency Band	
Level	Test field strength (V/m)
1	1
2	3
3	10
X	Specified
Remark: "X" is an open class.	

9.3. Measurement equipment

Instrument/Ancillary	Manufacturer	Model No.	Serial No.	Calibration Date	Valid Date.
Signal Generator	R&S	SML03	103287	2013.03.10	2014.03.09
Power Sensor	R&S	NR P-Z91	100383	2013.03.10	2014.03.09
Power Sensor	R&S	NRP-Z91	100384	2013.03.10	2014.03.09
Power Meter	R&S	NRP	101206	2013.03.10	2014.03.09
Power Amplifier	BONN	BLWA0830-16 0/100/40D	076659	2013.03.10	2014.03.09
Istropic Electric Field Probe	EST.LINDGRE N	HI-6105	137445	2012.09.26	2013.09.25
EMS Antenna	R&S	HL046E	100028	N/A	N/A
Temperature/ Humidity Meter	feiyang	N/A	101	2013.03.10	2014.03.09



9.4. Test Result and Data

Basic Standard : IEC 61000-4-3
 Final Test Result : PASS
 Model No. : 230LM00024
 Frequency Range : 80~1000 MHz
 Temperature : 20°C
 Relative Humidity : 50 %
 Atmospheric Pressure : 100 kPa
 Test Date : Jul 23, 2013

Test Mode : Mode 1& Mode 4& Mode 7

Modulation : AM 80% , 1KHz sine wave , Dwell time: 3.0 S				
Frequency Step Size : 1 % of preceding frequency value				
Frequency (MHz)	Antenna Polarization	face	Field strength (V/m)	Result
80~1000	Vertical	Front	3 V/m	A
80~1000	Vertical	Rear	3 V/m	A
80~1000	Vertical	Left	3 V/m	A
80~1000	Vertical	Right	3 V/m	A
80~1000	Horizontal	Front	3 V/m	A
80~1000	Horizontal	Rear	3 V/m	A
80~1000	Horizontal	Left	3 V/m	A
80~1000	Horizontal	Right	3 V/m	A

Test engineer: Seben



9.5. Test Photographs





10. Electrical Fast Transient/ Burst Immunity Test

10.1. Test Procedure

- a. In order to minimize the effect of environmental parameters on test results, the climatic conditions when test is carrying out shall comply with the following requirements:
 - ✧ ambient temperature: 15°C to 35°C;
 - ✧ relative humidity : 45% to 75%;
 - ✧ Atmospheric pressure: 86 Kpa (860 hPa) to 106 Kpa (1060 hPa).
- b. In order to minimize the effect of environmental parameters on test results, the electromagnetic environment of the laboratory shall not influence the test results.
- c. The variety and diversity of equipment and systems to be tested make it difficult to establish general criteria for the evaluation of the effects of fast transients/bursts on equipment and systems.
- d. Test on Power Line:
 - ✧ The EFT/B-generator was located on the GRP.. The length from the EFT/B-generator to the EUT is not exceeding 1 m.
 - ✧ The EFT/B-generator provides the ability to apply the test voltage in a non-symmetrical condition to the power supply input terminals of the EUT.
- e. Test on Communication Lines
 - ✧ The coupling clamp is composed of a clamp unit for housing the cable (length more than 3 m), and was placed on the GRP.
 - ✧ The coupling clamp provides the ability of coupling the fast transient/bursts to the cable under test.
- f. The test results may be classified on the basic of the operating conditions and the functional specification of the equipment under test, according to the following performance criteria :
 - ✧ Normal performance within the specification limits.
 - ✧ Temporary degradation or loss of function or performance which is self-recoverable.
 - ✧ Temporary degradation or loss of function or performance which requires operator intervention or system reset.
 - ✧ Degradation or loss of function which is not recoverable due to damage of equipment (components).



10.2. Test Severity Levels

The following test severity levels are recommended for the fast transient/burst test :

Open circuit output test voltage $\pm 10\%$		
Level	On Power Supply	On I/O signal, data and control line
1	0.5 kV	0.25 kV
2	1.0 kV	0.50 kV
3	2.0 kV	1.00 kV
4	4.0 kV	2.00 kV
X	Specified	Specified

Remark : “ X ” is an open level. The level is subject to negotiation between the user and the manufacturer or is specified by the manufacturer.

10.3. Measurement equipment

Instrument/Ancillary	Manufacturer	Model No.	Serial No.	Calibration Date	Valid Date.
TRANSIENT	EMCPARTNER	TRA2000IN6	901	2013.03.10	2014.03.09
CDN	EMCPARTNER	CDN200-06-32	121	2013.03.10	2014.03.09
Coupling clamp	EMCPARTNER	CN-EFT1000	547	2013.03.10	2014.03.09
Temperature/ Humidity Meter	Zhicheng	ZC1-11	CEP-TH-005	2013.03.10	2014.03.09



10.4. Test Result and Data

Basic Standard : IEC 61000-4-4
 Final Test Result : PASS
 Model No. : 230LM00024
 Test Voltage : On Power Supply -- ±1.0 kV
 : On I/O signal, data and control line -- ±0.5 kV
 Temperature : 21°C
 Relative Humidity : 51 %
 Atmospheric Pressure : 100 kPa
 Test Date : Jul 23, 2013

Test Mode : Mode 1& Mode 4& Mode 7

Pulse : 5/50 ns		Repetition Rate: <u>5 kHz</u> above 2.0 kV			
Burst : 15m/300ms		5 <u>kHz</u> below and equal 2.0 kV			
Test time : 1 min/each condition					
Voltage/ Mode/ Polarity/ Result/ Phase		<u>0.5 kV</u>		<u>1.0 kV</u>	
		+	-	+	-
Power Line	L	---	---	A	A
	N	---	---	A	A
	L-N	---	---	A	A
	PE	---	---	A	A
	L-PE	---	---	A	A
	N-PE	---	---	A	A
	L-N-PE	---	---	A	A

Test engineer: Seben



10.5. Test Photographs





11. Surge Immunity Test

11.1. Test Procedure

a. Climatic conditions

The climatic conditions shall comply with the following requirements :

- ✧ ambient temperature : 15 °C to 35 °C
- ✧ relative humidity : 10 % to 75 %
- ✧ atmospheric pressure : 86 kPa to 106 kPa (860 hPa to 1060 hPa)

b. Electromagnetic conditions

the electromagnetic environment of the laboratory shall not influence the test results.

c. The test shall be performed according the test plan that shall specify the test set-up with

- ✧ generator and other equipment utilized;
- ✧ test level (voltage/current);
- ✧ generator source impedance;
- ✧ internal or external generator trigger;
- ✧ number of tests : at least five positive and five negative at the selected points;
- ✧ repetition rate : maximum 1/min.
- ✧ inputs and outputs to be tested;
- ✧ representative operating conditions of the EUT;
- ✧ sequence of application of the surge to the circuit;
- ✧ phase angle in the case of AC. power supply;
- ✧ actual installation conditions, for example :

AC : neutral earthed,

DC : (+) or (-) earthed to simulated the actual earthing conditions.

- d. If not otherwise specified the surges have to be applied synchronized to the voltage phase at the zero-crossing and the peak value of the AC. voltage wave (positive and negative).
- e. The surges have to be applied line to line and line(s) and earth. When testing line to earth, the test voltage has to be applied successively between each of the lines and earth, if there is no other specification.
- f. The test procedure shall also consider the non-linear current-voltage characteristics of the equipment under test. Therefore the test voltage has to be increased by steps up to the test level specified in the product standard or test plan.
- g. All lower levels including the selected test level shall be satisfied. For testing the secondary protection, the output voltage of the generator shall be increased up to the worst-case voltage breakdown level (let-through level) of the primary protection.
- h. If the actual operating signal sources are not available, that may be simulated. Under no circumstances may the test level exceed the product specification. The test shall be carried out according to a test plan.
- i. To find all critical points of the duty cycle of the equipment, a sufficient number of positive and negative test pulses shall be applied. For acceptance test previously unstressed equipment shall be used to the protection devices shall be replaced.

**11.2. Test Severity Level**

Level	Open-circuit test voltage, $\pm 10\%$, kV
1	0.5
2	1.0
3	2.0
4	4.0
X	Specified

NOTE: "X" is an open class. This level can be specified in the product specification.

11.3. Measurement equipment

Instrument/Ancillary	Manufacturer	Model No.	Serial No.	Calibration Date	Valid Date.
TRANSIENT	EMCPARTNER	TRA2000IN6	901	2013.03.10	2014.03.09
CDN	EMCPARTNER	CDN-UTP8	021	2013.03.10	2014.03.09
CDN	EMCPARTNER	CDN200-06-32	121	2013.03.10	2014.03.09
Temperature/ Humidity Meter	Zhicheng	ZC1-11	CEP-TH-005	2013.03.10	2014.03.09



11.5. Test Photographs





12. Conduction Disturbances induced by Radio-Frequency Fields

12.1. Test Procedure

- a. The EUT shall be operated within its intended climatic conditions. The temperature and relative humidity should be recorded.
- b. This test method test can be performed without using a sell shielded enclosure. This is because the disturbance levels applied and the geometry of the setups are not likely to radiated a high amount of energy, especially at the lower frequencies. If under certain circumstances the radiated energy is too high, a shielded enclosure has to be used.
- c. The test shall be performed with the test generator connected to each of the coupling and decoupling devices in turn while the other non-excited RF-input ports of the coupling devices are terminated by a 50 ohm load resistor.
- d. The frequency range is swept from 150 KHz to 80 MHz, using the signal levels established during the setting process, and with the disturbance signal 80% amplitude modulated with a 1KHz sign wave, pausing to adjust the RF-signal level or to switch coupling devices as necessary. The rate of sweep shall no exceed 1.5×10^{-3} decades/s. Where the frequency is swept incrementally, the step size shall no exceed 1% of the start and thereafter 1% of the preceding frequency value.
- e. The dwell time at each frequency shall not be less than the time necessary for the EUT to be exercised, and able to respond. Sensitive frequencies e.g. clock frequency (ies) and harmonics or frequencies of dominant interest shall be analyzed separately.
- f. An alternative test procedure may be adopted, wherein the frequency range is swept incrementally, with a step size not exceeding 4% of the start ad thereafter 4% of the preceding frequency value. The test level should be at least twice the value of the specified test level.
- g. In cases of dispute, the test procedure using a step size not exceeding 1% of the start and thereafter 1% of preceding frequency value shall take precedence.
- h. Attempts should be made to fully exercise the EUT during testing, and to fully interrogate all exercise modes selected for susceptibility.
- i. The use of special exercising programs is recommended.
- j. Testing shall be performed according to a Test Plan, which shall be included in the test report.
- k. It may be necessary to carry out some investigatory testing in order to establish some aspects of the test plan.



12.2. Test Severity Levels

Level	Voltage Level (EMF),
1	1 V
2	3 V
3	10 V
x	Specified
NOTE - x is an open class. This level can be specified in the product specification.	

12.3. Measurement equipment

Instrument/Ancillary	Manufacturer	Model No.	Serial No.	Calibration Date	Valid Date.
Conducted immunity test system	FRANKONIA	CIT-10/75	102D1294	2013.03.10	2014.03.09
EM Injection clamp	FCC	F-203I-23MM	536	2013.03.10	2014.03.09
CDN	FRANKONIA	CDN-T2	A3010029	2013.03.10	2014.03.09
CDN	FRANKONIA	CDN-T4	A3015017	2013.03.10	2014.03.09
CDN	FRANKONIA	CDN-T8	A3022010	2013.03.10	2014.03.09
CDN	FRANKONIA	CDN-M2	A3002037	2013.03.10	2014.03.09
CDN	FRANKONIA	CDN-M2+M3	A3011102	2013.03.10	2014.03.09
CDN	FCC	CDN-M5/32	A3013024	2013.03.10	2014.03.09
6 dB Attenuator	FRANKONIA	N/A	N/A	2013.03.10	2014.03.09
Temperature/ Humidity Meter	Zhicheng	ZC1-11	CEP-TH-005	2013.03.10	2014.03.09



12.4. Test Result and Data

Basic Standard : IEC 61000-4-6
 Final Test Result : PASS
 Model No. : 230LM00024
 Coupling mode : CDN-(M2+M3) for AC power ports
 : CDN-T4 for signal ports
 : EM-Clamp for signal ports
 Temperature : 21 °C
 Relative Humidity : 51 %
 Atmospheric Pressure : 100 kPa
 Test Date : Jul 23, 2013

Test Mode : Mode 1& Mode 4& Mode 7

Frequency : 0.15~80MHz, Modulation : AM 80%,1KHz sine wave, Dwell time: 2.9s			
Frequency Step Size : 1 % of preceding frequency value			
Frequency	Test mode	Voltage(V)	Result
0.15 ~ 80MHz	Power(M3)	3	A

Test engineer: Seben



12.5. Test Photographs





13. Power Frequency Magnetic Field Immunity Tests

13.1. Test Setup

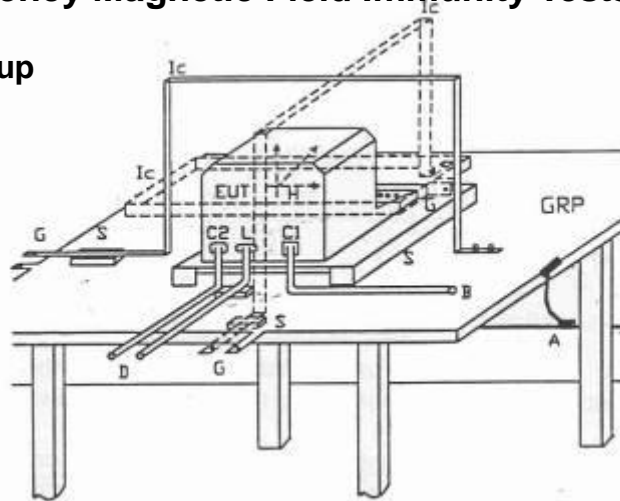

GPR	: Ground plane	C1	: Power supply circuit
A	: Safety earth	C2	: Signal circuit
S	: Insulating support	L	: Communication line
EUT	: Equipment under test	B	: To power supply source
Lc	: Induction coil	D	: To signal source, simulator
E	: Earth terminal	G	: To the test generator

13.2. Test Severity Levels

Level	Magnetic field strength A/m
1	1
2	3
3	10
4	30
5	100
X ¹⁾	special

NOTE 1 "X" is an open level. This level can be given in the product specification.

13.3. Measurement equipment

Instrument/Ancillary	Manufacturer	Model No.	Serial No.	Calibration Date	Valid Date.
TRANSIENT	EMCPARTNER	TRA2000IN6	901	2013.03.10	2014.03.09
H-Filed-Loop	EMCPARTNER	MF1000-1	144	2013.03.10	2014.03.09
Temperature/ Humidity Meter	Zhicheng	ZC1-11	CEP-TH-005	2013.03.10	2014.03.09



13.4. Test Result and Data

Basic Standard : IEC 61000-4-8
Final Test Result : PASS
Model No. : 230LM00024
Temperature : 21 °C
Relative Humidity : 51 %
Atmospheric Pressure : 100 kPa
Test Date : Jul 23, 2013

Test Mode : Mode 1& Mode 4& Mode 7

Power Frequency Magnetic Field : 50 Hz, 1 A/m		
Coil Orientation	Testing duration	Results
X-axis	1.0 Min	A
Y-axis	1.0 Min	A
Z-axis	1.0 Min	A

Test engineer: Seben



13.5. Test Photographs





14. Voltage Dips and Voltage Interruptions Immunity Test Setup

14.1. Test Conditions

1. Source voltage and frequency : 230V / 50Hz, Single phase.
2. Test of interval : 10 sec.
3. Level and duration : Sequence of 3 dips/interrupts.
4. Voltage rise (and fall) time : 1 ~ 5 μ s.
5. Test severity :

Voltage dips and Interrupt reduction (%)	Test Duration (period)
>95%	250
30%	25
>95%	0.5

14.2. Measurement equipment

Instrument/Ancillary	Manufacturer	Model No.	Serial No.	Calibration Date	Valid Date.
TRANSIENT	EMCPARTNER	TRA2000IN6	901	2013.03.10	2014.03.09
Temperature/ Humidity Meter	Zhicheng	ZC1-11	CEP-TH-005	2013.03.10	2014.03.09



14.3. Test Result and Data

Basic Standard : IEC 61000-4-11
 Final Test Result : PASS
 Model No. : 230LM00024
 Pass performance Criteria : C for voltage interruption, B for voltage dips
 Temperature : 21 °C
 Relative Humidity : 51 %
 Atmospheric Pressure : 100 kPa
 Test Date : Jul 23, 2013

Test Mode : Mode 1& Mode 4& Mode 7										
Voltage(UT): AC 230 V 50 Hz Interval(s) : 10s Times : 3										
Test mod	Test level UT %	Durations (period / ms)	Phase / Result							
			0	45	90	135	180	225	270	315
Voltage interruptions	>95%	250	C	C	C	C	C	C	C	C
Voltage dips	30%	25	A	A	A	A	A	A	A	A
	>95%	0.5	A	A	A	A	A	A	A	A

Test engineer: Seben



14.4. Test Photographs





15. Photographs of EUT

1) EUT Photo



2) EUT Photo





3) EUT Photo



4) EUT Photo





5) EUT Photo

