

USER MANUAL



CU34E4CV MONITOR

AOC.COM

©2025 AOC. All rights reserved

Version: A00

AOC

Safety	1
National Conventions.....	1
Power	2
Installation	3
Cleaning.....	4
Other	5
Setup.....	6
Contents in Box.....	6
Set-up Stand & Base.....	7
Adjusting Viewing Angle.....	9
Connecting the Monitor	10
KVM function	11
Wall Mounting	13
Adaptive-Sync function.....	14
Adjusting.....	15
Hotkeys.....	15
OSD Setting	16
Game Setting.....	17
Preset Mode.....	19
Picture	20
Input.....	22
PIP/PBP	23
Settings.....	25
Off /On	25
Audio	26
OSD Setup.....	27
Information.....	28
LED Indicator.....	29
Troubleshoot.....	30
Specification	31
General Specification.....	31
AOC Monitors Panel Pixel Defect Policy.....	33
Preset Display Modes.....	35
Recommendations to prevent Computer Vision Syndrome (CVS).....	36
Pin Assignments.....	37
Plug and Play.....	38

Safety

National Conventions

The following subsections describe national conventions used in this document.

Notes, Cautions, and Warnings

Throughout this guide, blocks of text may be accompanied by an icon and printed in bold type or in italic type. These blocks are notes, cautions, and warnings, and they are used as follows:



NOTE: A NOTE indicates important information that helps you make better use of your computer system.





CAUTION: A CAUTION indicates either potential damage to hardware or loss of data and tells you how to avoid the problem.



WARNING: A WARNING indicates the potential for bodily harm and tells you how to avoid the problem. Some warnings may appear in alternate formats and may be unaccompanied by an icon. In such cases, the specific presentation of the warning is mandated by regulatory authority.

Power

 The monitor should be operated only from the type of power source indicated on the label. If you are not sure of the type of power supplied to your home, consult your dealer or local power company.

 The monitor is equipped with a three-pronged grounded plug, a plug with a third (grounding) pin. This plug will fit only into a grounded power outlet as a safety feature. If your outlet does not accommodate the three-wire plug, have an electrician install the correct outlet, or use an adapter to ground the appliance safely. Do not defeat the safety purpose of the grounded plug.

 Unplug the unit during a lightning storm or when it will not be used for long periods of time. This will protect the monitor from damage due to power surges.

 Do not overload power strips and extension cords. Overloading can result in fire or electric shock.

 To ensure satisfactory operation, use the monitor only with UL listed computers which have appropriate configured receptacles marked between 100-240V AC, Min. 5A.

 The wall socket shall be installed near the equipment and shall be easily accessible.

Installation

! Do not place the monitor on an unstable cart, stand, tripod, bracket, or table. If the monitor falls, it can injure a person and cause serious damage to this product. Use only a cart, stand, tripod, bracket, or table recommended by the manufacturer or sold with this product. Follow the manufacturer's instructions when installing the product and use mounting accessories recommended by the manufacturer. A product and cart combination should be moved with care.

! Never push any object into the slot on the monitor cabinet. It could damage circuit parts causing a fire or electric shock. Never spill liquids on the monitor.

! Do not place the front of the product on the floor.

! If you mount the monitor on a wall or shelf, use a mounting kit approved by the manufacturer and follow the kit instructions.

! Leave some space around the monitor as shown below. Otherwise, air-circulation may be inadequate hence overheating may cause a fire or damage to the monitor.

! To avoid potential damage, for example the panel peeling from the bezel, ensure that the monitor does not tilt downward by more than -5 degrees. If the -5 degree downward tilt angle maximum is exceeded, the monitor damage will not be covered under warranty.

See below the recommended ventilation areas around the monitor when the monitor is installed on the wall or on the stand:

Installed with stand



Cleaning

! Clean the cabinet regularly with a water-dampened, soft cloth.

! When cleaning use a soft cotton or microfiber cloth. The cloth should be damp and almost dry, do not allow liquid into the case.



! Please disconnect the power cord before cleaning the product.

Other

 If the product is emitting a strange smell, sound or smoke, disconnect the power plug IMMEDIATELY and contact a Service Center.

 Make sure that the ventilating openings are not blocked by a table or curtain.

 Do not engage the LCD monitor in severe vibration or high impact conditions during operation.

 Do not knock or drop the monitor during operation or transportation.

 The power cords shall be safety approved. For Germany, it shall be H03VV-F, 3G, 0.75 mm², or better. For other countries, the suitable types shall be used accordingly.

 Excessive sound pressure from earphones and headphones can cause hearing loss. Adjustment of the equalizer to maximum increases the earphones and headphones output voltage and therefore the sound pressure level.

Setup

Contents in Box

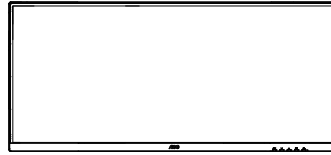

Monitor



Quick Start Guide

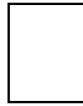

Warranty Card



Stand



Base



Power Cable



HDMI Cable



DisplayPort Cable



USB Cable



USB C-C Cable

*Not all signal cables will be provided for all countries and regions. Please check with the local dealer or AOC branch office for confirmation.

Set-up Stand & Base

Please setup or remove the base following the steps as below.

Setup:

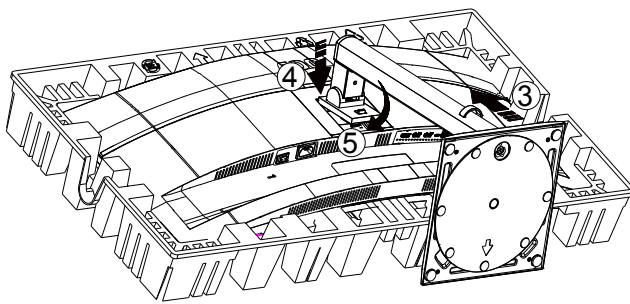
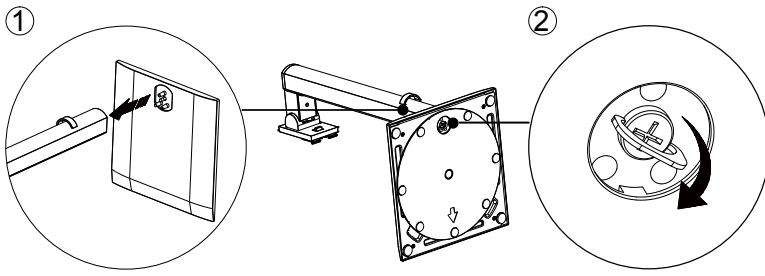

Remove:

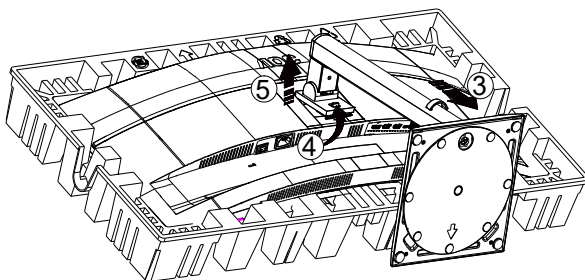
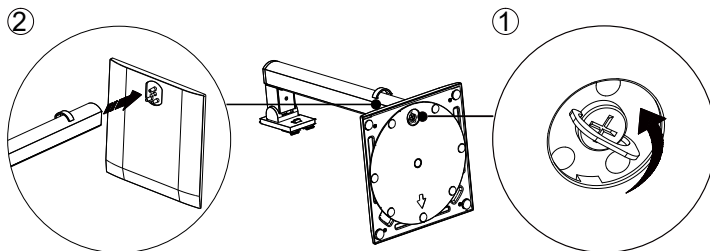

Specification for base screw: M6*19 mm (effective thread 5.5 mm)

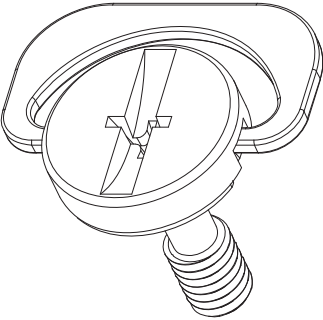

 **NOTE:** Display design may differ from those illustrated.

Adjusting Viewing Angle

To achieve the best viewing experience, it is recommended that the user can make sure they are able to look at their whole face on the screen, then adjust the monitor's angle based on personal preference.

Hold the stand so you will not topple the monitor when you change the monitor's angle.

You are able to adjust the monitor as below:

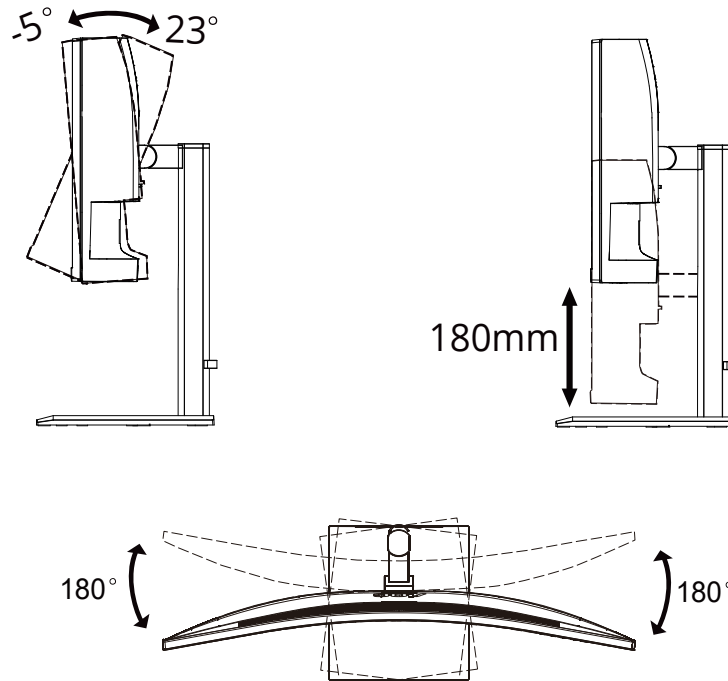

NOTE:

Do not touch the LCD screen when you change the angle. Touching the LCD screen may cause damage.

Warning

- To avoid potential screen damage, such as panel peeling, ensure that the monitor does not tilt downward by more than -5 degrees.
- Do not press the screen while adjusting the angle of the monitor. Grasp only the bezel.

Connecting the Monitor

Cable Connections In Back of Monitor and Computer:

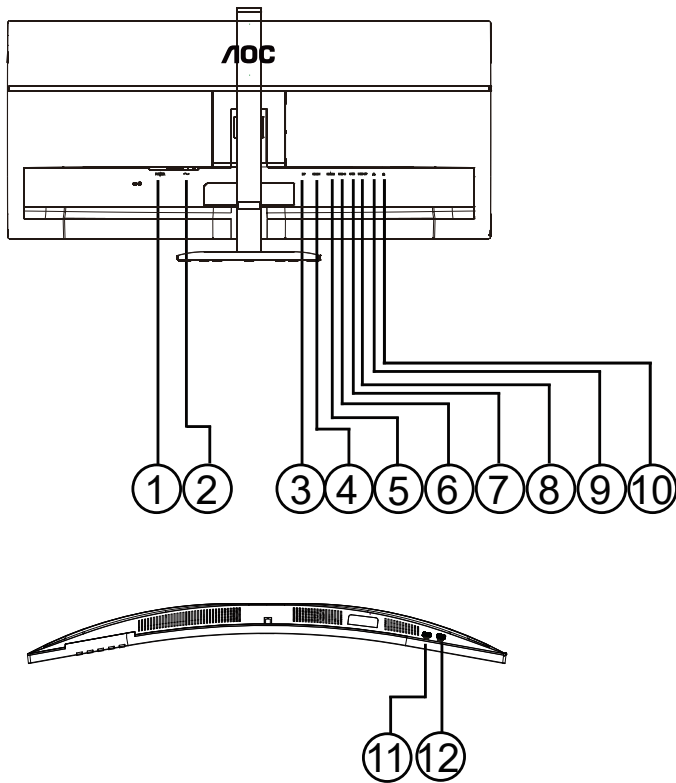

1. Power Switch
2. Power
3. DisplayPort
4. HDMI 1
5. HDMI 2
6. USB C
7. USB3.2 Gen1x2
8. USB Upstream
9. RJ45 Input
10. Earphone
11. USB3.2 Gen1x1
12. USB3.2 Gen1 downstream+chargingx1

Connect to PC

1. Connect the power cord to the back of the display firmly.
2. Turn off your computer and unplug its power cable.
3. Connect the display signal cable to the video connector on the back of your computer.
4. Plug the power cord of your computer and your display into a nearby outlet.
5. Turn on your computer and display.

If your monitor displays an image, installation is complete. If it does not display an image, please refer to Troubleshoot.

To protect equipment, always turn off the PC and LCD monitor before connecting.

KVM function

What is KVM?

With KVM function, you can show two PCs, or two notebooks, or one PC and one notebook on one AOC monitor and control the two devices with one set of keyboard and mouse. Switch your control over your PC or notebook devices by choosing input signal source on "Input Select" of OSD menu.

How to use KVM?

Step 1: Please connect one device (PC or notebook) to monitor via USB C.

Step 2: Please connect the other device to monitor via HDMI or DisplayPort. Then please also connect this device to monitor with USB upstream.

Step 3: Please connect your peripherals (keyboard and mouse) to monitor via USB port.

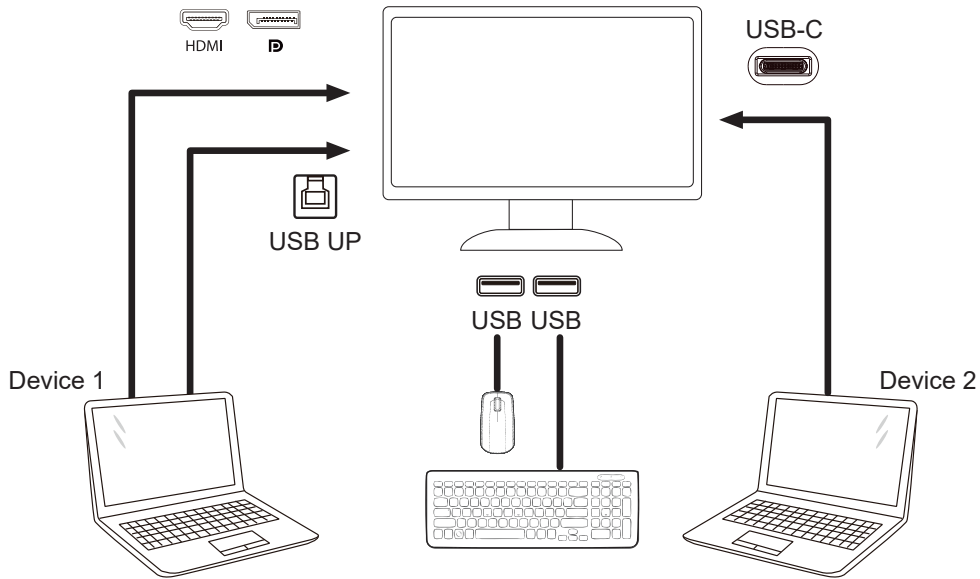

Note: Display design may differ from that illustrated

Step 4: Enter to Settings. Go to OSD Setup page and select "Auto", "USB C", or "USB UP" of USB Selection tab.

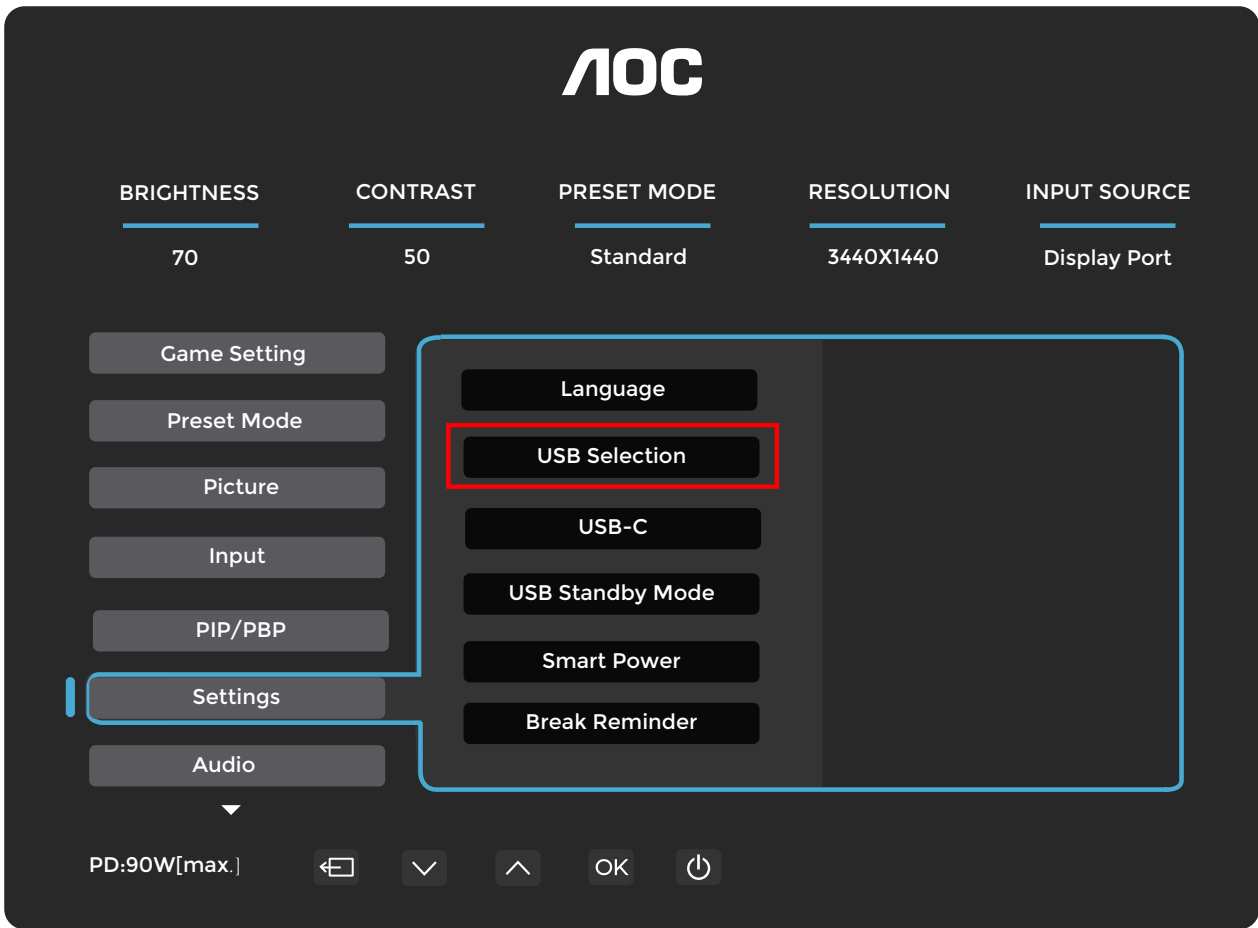

USB Selection	Function Description
Auto	Auto selects USB C or USB Up depending on the input source.
USB C	Provides USB Hub function through USB C cable.
USB up	Provides USB Hub function through USB up cable.

Wall Mounting

Preparing to Install An Optional Wall Mounting Arm.

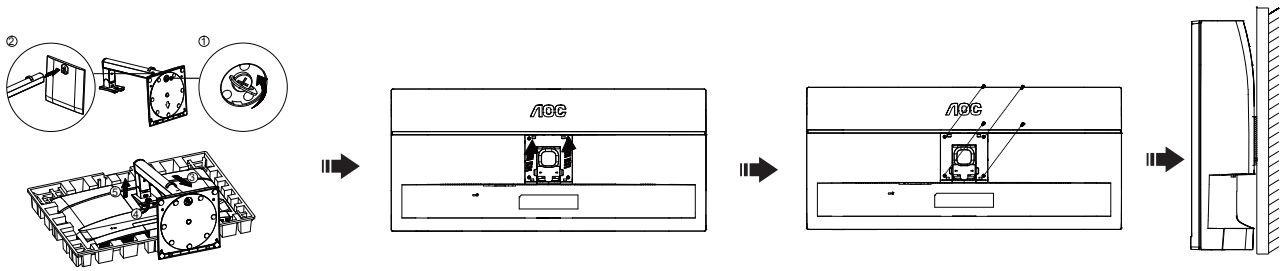

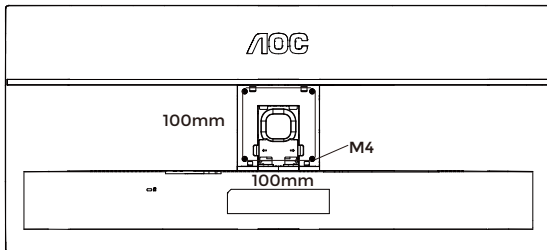

This monitor can be attached to a wall mounting arm you purchase separately. Disconnect power before this procedure. Follow these steps:

1. Remove the base.
2. Follow the manufacturer's instructions to assemble the wall mounting arm.
3. Place the wall mounting arm onto the back of the monitor. Line up the holes of the arm with the holes in the back of the monitor.
4. Insert the 4 screws into the holes and tighten.
5. Reconnect the cables. Refer to the user's manual that came with the optional wall mounting arm for instructions on attaching it to the wall.

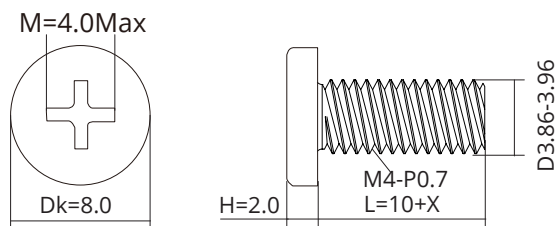

Specification of wall hanger screws: M4*(10+X)mm, (X=Thickness of Wall mount bracket)



 **Noted:** VESA mounting screw holes are not available for all models, please check with the dealer or official department of AOC. Always contact manufacturer for wall-mount installation.

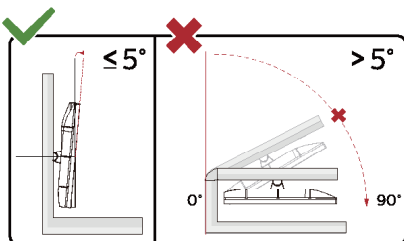

* Display design may differ from those illustrated.

⚠WARNING:

1. To avoid potential screen damage, such as panel peeling, ensure that the monitor does not tilt downward by more than -5 degrees.
2. Do not press the screen while adjusting the angle of the monitor. Grasp only the bezel.

Adaptive-Sync function

1. Adaptive-Sync function works with DisplayPort/HDMI/USC C
2. Compatible Graphics Card: Recommended list is as below, also could be checked by visiting www.AMD.com

Graphics Cards

- Radeon™ RX Vega series
- Radeon™ RX 500 series
- Radeon™ RX 400 series
- Radeon™ R9/R7 300 series (R9 370/X, R7 370/X, R7 265 except)
- Radeon™ Pro Duo (2016)
- Radeon™ R9 Nano series
- Radeon™ R9 Fury series
- Radeon™ R9/R7 200 series (R9 270/X, R9 280/X except)

Processors

- AMD Ryzen™ 7 2700U
- AMD Ryzen™ 5 2500U
- AMD Ryzen™ 5 2400G
- AMD Ryzen™ 3 2300U
- AMD Ryzen™ 3 2200G
- AMD PRO A12-9800
- AMD PRO A12-9800E
- AMD PRO A10-9700
- AMD PRO A10-9700E
- AMD PRO A8-9600
- AMD PRO A6-9500
- AMD PRO A6-9500E
- AMD PRO A12-8870
- AMD PRO A12-8870E
- AMD PRO A10-8770
- AMD PRO A10-8770E
- AMD PRO A10-8750B
- AMD PRO A8-8650B
- AMD PRO A6-8570
- AMD PRO A6-8570E
- AMD PRO A4-8350B
- AMD A10-7890K
- AMD A10-7870K
- AMD A10-7850K
- AMD A10-7800
- AMD A10-7700K
- AMD A8-7670K
- AMD A8-7650K
- AMD A8-7600
- AMD A6-7400K

Adjusting

Hotkeys

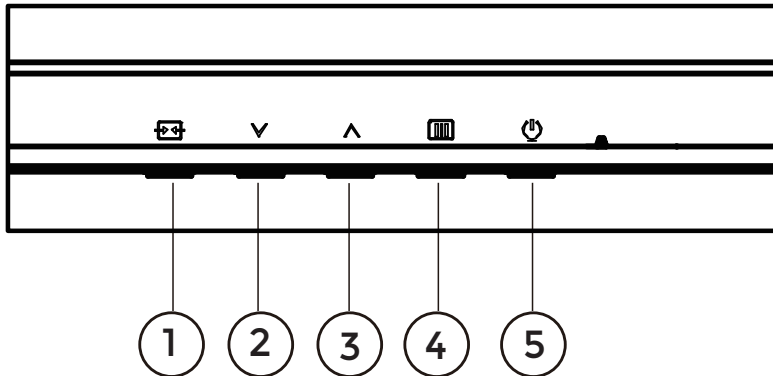

1	Source/Exit
2	User Key(Default: Color Space)/▽
3	USB Selection/△
4	Menu/Enter
5	Power

Menu/Enter

Press to display the OSD or confirm the selection.

Power

Press the Power button to turn on the monitor.

User Key (Game Mode)/▽

Customize this shortcut key function in OSD menu: Color Space, Preset Mode, Brightness, Volume, Language, Gamma, Color Temp. The factory default is Color Space.

When there is no OSD, press "▽" key to open Color Space function, then press "▽" or "△" key to select Color Space (Panel Native, sRGB).

USB Selection/△

When there is no OSD, press "△" key to open USB Selection function, then press "▽" or "△" key to adjust the Auto, USB C, USB up.

Source/Exit

When the OSD is closed, press Source/Exit button will be Source hot key function.

When the OSD menu is active, this button acts as an exit key (to exit the OSD menu).

OSD Setting

Basic and simple instruction on the control keys.

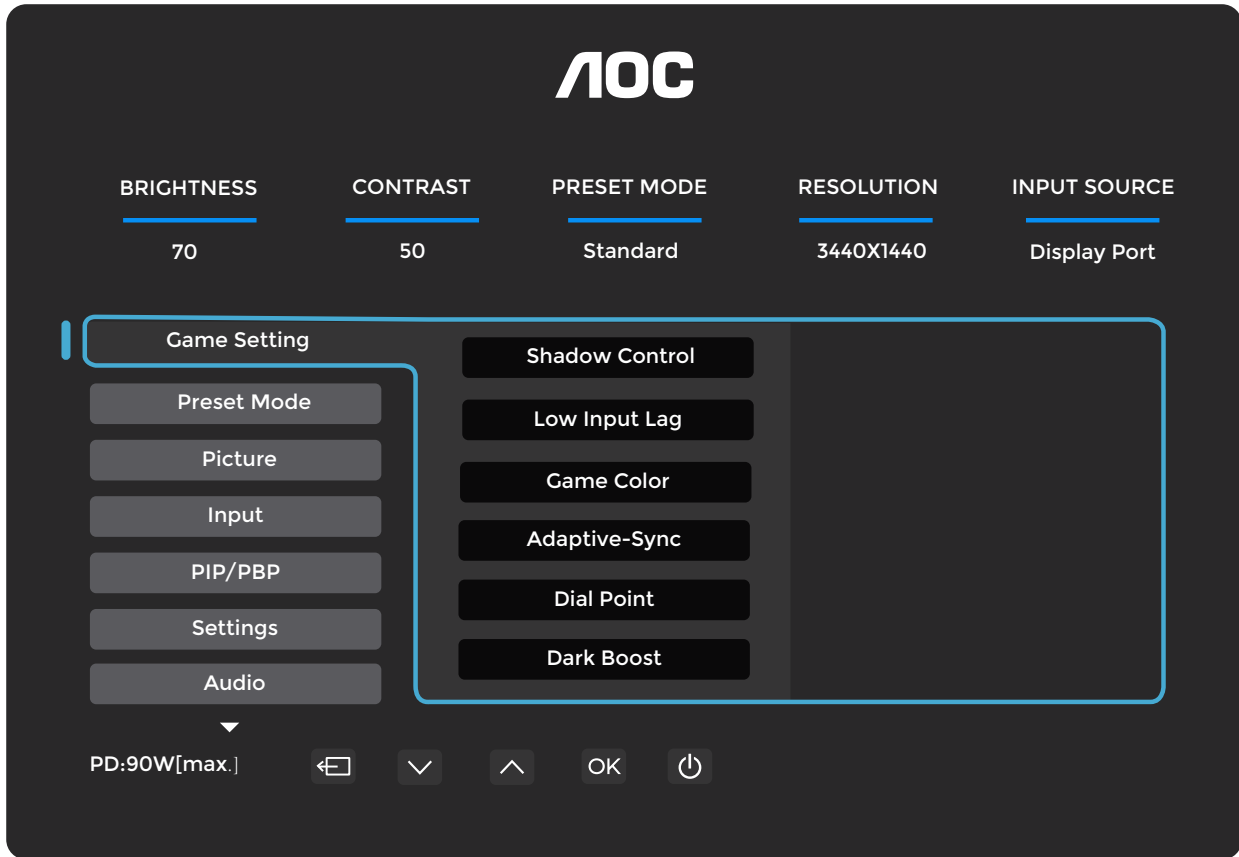

- 1). Press the **MENU-button** to activate the OSD window.
- 2). Press \downarrow or \uparrow to navigate through the functions. Once the desired function is highlighted, press the **MENU-button / OK** to activate it, press \downarrow or \uparrow to navigate through the sub-menu functions. Once the desired sub-menu function is highlighted, press **MENU-button / OK** to activate it.
- 3). Press \downarrow or \uparrow to change the settings of the selected function. Press \leftarrow / \rightarrow to exit. If you want to adjust any other function, repeat steps 2-3.
- 4). OSD Lock Function: To lock the OSD, press and hold the **MENU-button** while the monitor is off and then press power button to turn the monitor on. To unlock the OSD - press and hold the **MENU-button** while the monitor is off and then press power button to turn the monitor on.

Notes:

If the input signal resolution is the native resolution or Adaptive-Sync, then the item "Image Ratio" is invalid.

Game Setting

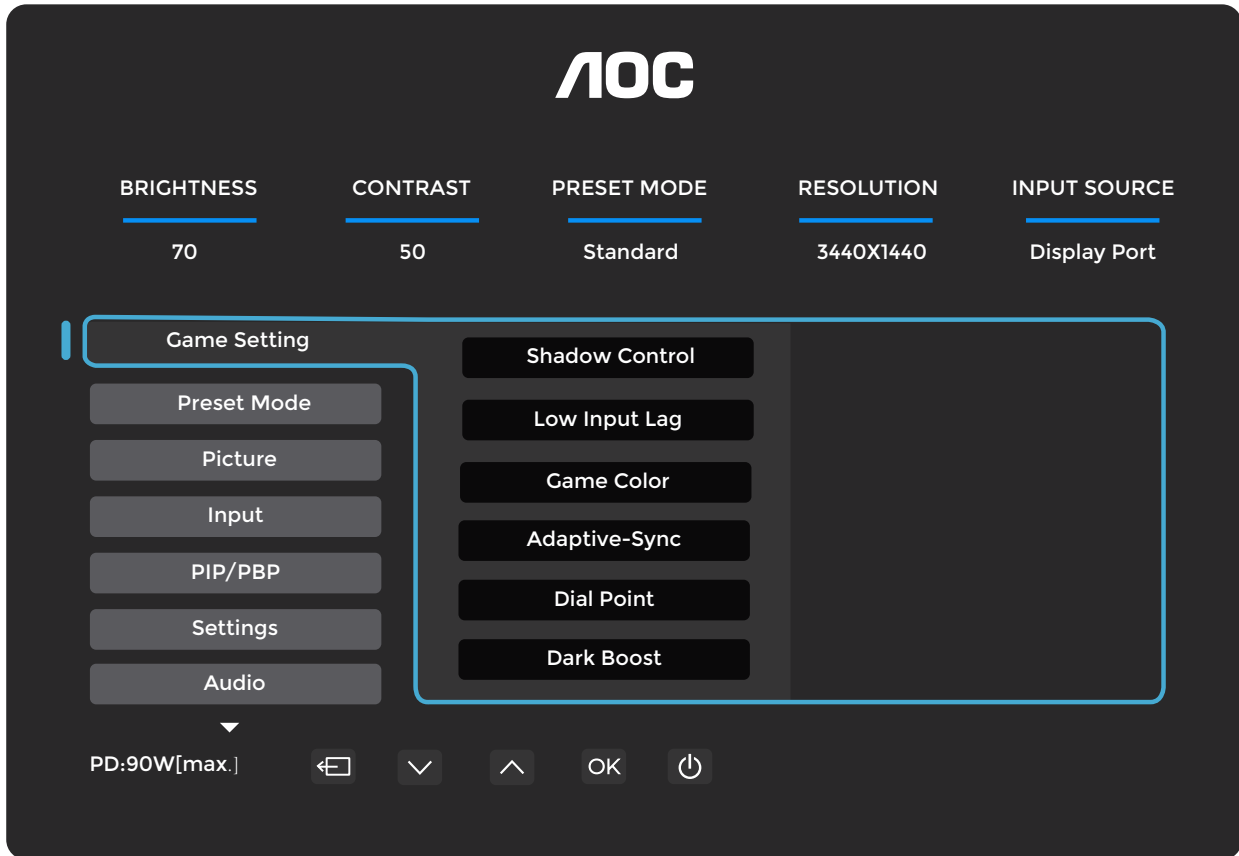

Shadow Control	0-20	Shadow Control Default is 0, then end-user can adjust from 0 to 20 increase for a clearer picture. If picture is too dark to be saw the detail clearly, adjusting from 0 to 20 for a clear picture.
Low Input Lag	Off / On	Turn off frame buffer to decrease input lag.
Game Color	0 ~ 20	Game Color will provide 0-20 level for adjusting saturation to get a better picture.
Adaptive-Sync	Off / On	Disable or Enable Adaptive-Sync. Adaptive-Sync Run Reminder: When the Adaptive-Sync feature is enabled, there may be flashing in some game environments.
Dial Point	Off / On / Dynamic	The "Dial Point" function places an aiming indicator in the center of screen for helping gamers to play First Person Shooter (FPS) games with accurate and precise aiming.
Dark Boost	Off / Level 1 / Level 2 / Level 3	Enhance the screen details in the dark or bright area to adjust the brightness in the bright area and ensure that it is not oversaturated.
MBR	0 ~ 20	MBR (Motion Blur Reduction) Provides 0-20 levels of adjustments to reduce motion blur. Note: 1. The MBR function can be adjusted when Adaptive-Sync is turned off, and the refresh rate $\geq 75\text{Hz}$. 2. The brightness of the screen will decrease as the adjustment value increases.
MBR Sync	Off / On	Disable or Enable MBR Sync (Motion Blur Remove).

Overdrive	Off / Weak / Medium / Strong / Boost	Adjusts the monitor's response time. Notes: Setting OverDrive to Strong may cause image blurring. Adjust or disable OverDrive based on personal viewing preferences. Boost is available only when Adaptive-Sync is disabled and the refresh rate is 75Hz or higher. Activating Boost will reduce screen brightness.
-----------	--------------------------------------	---

Note:

When using Reading, HDR Effect – Picture, HDR Effect – Movie, HDR Effect – Game, Uniformity, FPS, RTS, and Racing game modes, Dark Boost, Shadow Control, and Game Color will be disabled.

When HDR is enabled, Dark Boost, Shadow Control, and Game Color cannot be adjusted.

Preset Mode

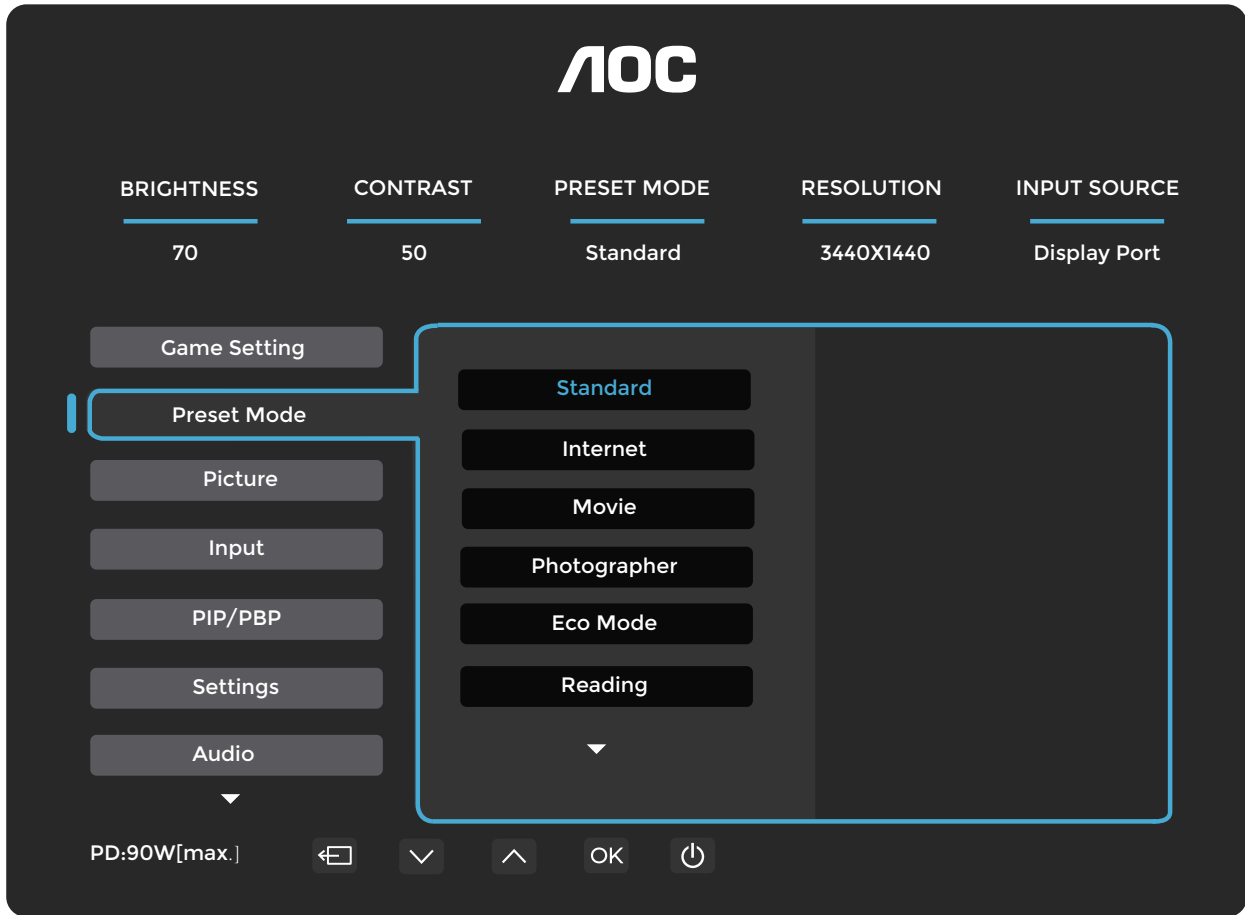

Standard		Enhance readability for suitable web and mobile games.
Internet		Internet Mode.
Movie		Movie Mode.
Photographer		Photographer Mode.
Eco Mode		Eco Mode
Reading		Reading Mode.
HDR Effect - Picture		Set the HDR Effect according to your usage requirements.
HDR Effect - Movie		
HDR Effect - Game		
Sports		Sports Mode.
Uniformity		Uniformity Mode
FPS		For playing FPS (First Person Shooters) games. Improves black level in dark theme.
RTS		For playing RTS (Real Time Strategy) games. Improves the image quality.
Racing		For playing Racing games, Provides fastest response time and high color saturation.
Reset Color	No / Yes	Reset the Color to default.

Picture

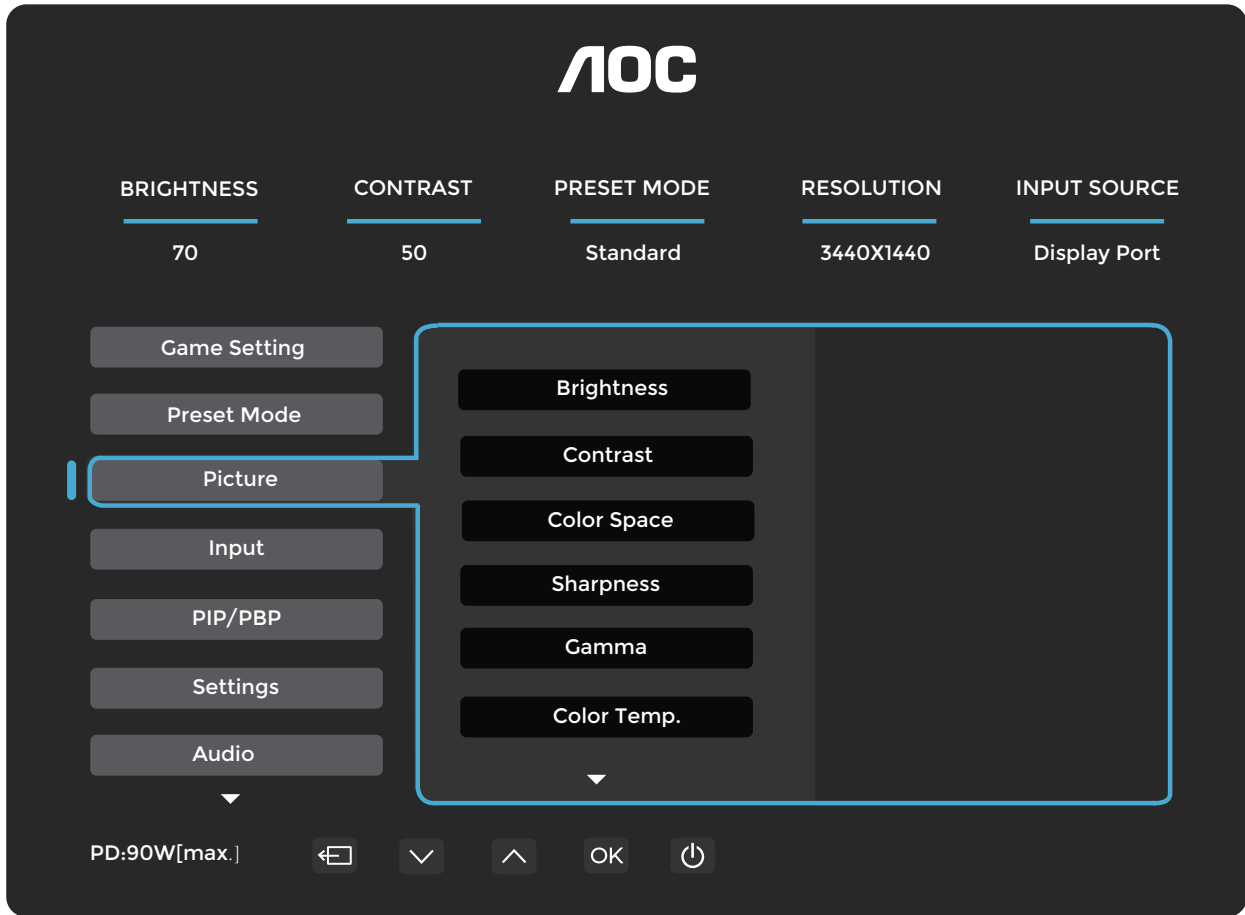

Brightness	0-100	Backlight Adjustment.
Contrast	0-100	Contrast from Digital-register.
Color Space	Panel Native	Standard color space panel.
	sRGB	sRGB Color space.
Sharpness	0-100	Sharpness Adjustment.
Gamma	1.8 / 2.0 / 2.2 / 2.4 / 2.6	Adjust Gamma.
Color Temp.	Native/5000K/ 6500K/7500K/ 8200K/9300K/ 11500K/User Define	Recall Color Temp. from EEPROM.
Red	0-100	Red gain from Digital-register.
Green	0-100	Green gain from Digital-register.
Blue	0-100	Blue gain from Digital-register.
DCR	Off / On	Disable /Disable dynamic contrast ratio.
Clear Vision	Off/Weak/Medium/ Strong	Adjust the Clear Vision
Image Ratio	Full/Aspect/1:1	Select image ratio for display.

Note:

- 1). When "Reading /HDR Effect – Picture/HDR Effect – Movie/HDR Effect – Game/Uniformity/FPS/RTS/Racing under "Preset Mode" is enable, the items "Contrast", "Color Space", "Gamma",cannot be adjusted.
- 2). When "HDR" is DisplayHDR, the items "Brightness", "Contrast", "Color Space", "Gamma", "Color Temp.", "Clear Vision", "DCR",cannot be adjusted.
- 3). When "HDR" is HDR Pictrue/Movie/Game, the items "Color Space", "Gamma", "Color Temp.", "DCR", cannot be adjusted.

Input

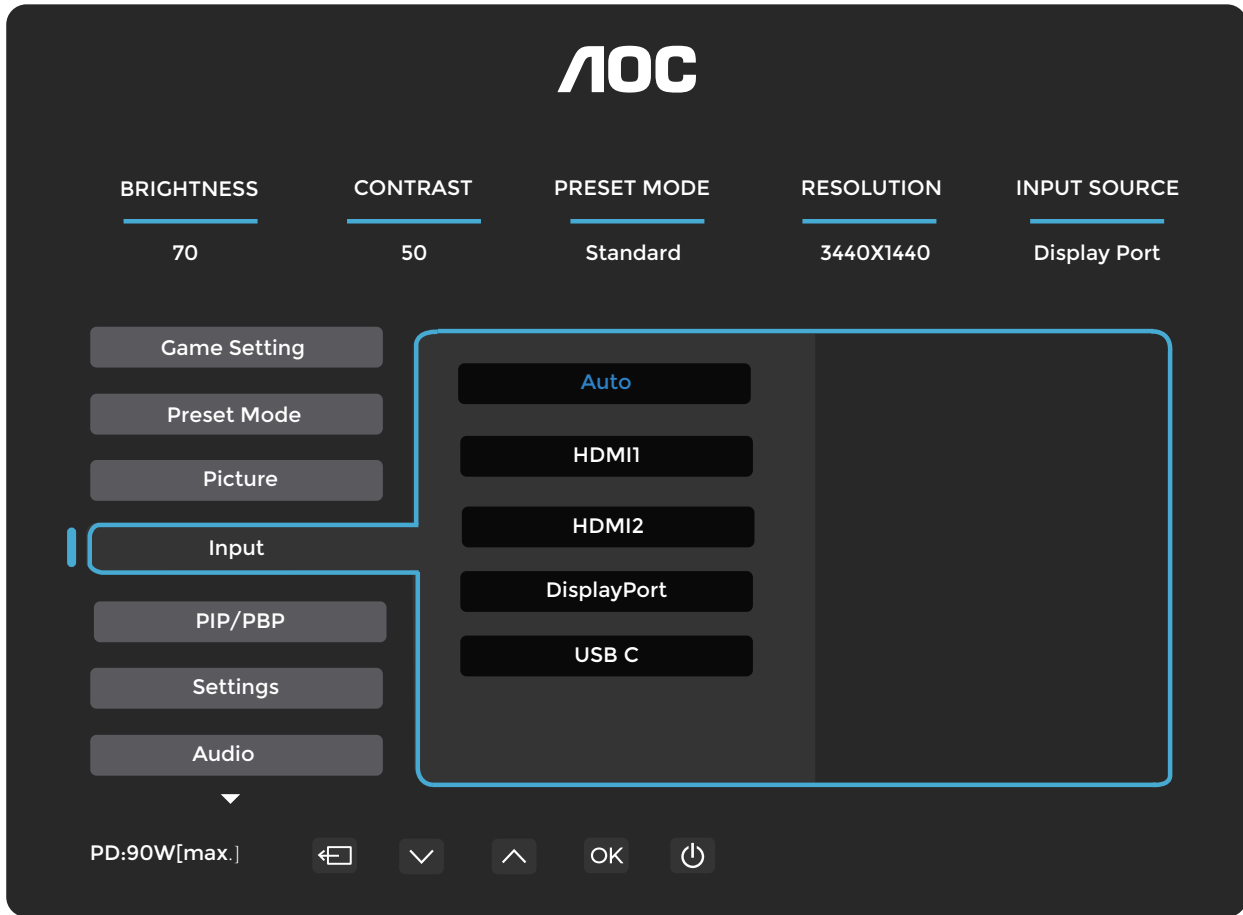

Auto		Select input signal source Automatically.
HDMI1		Select HDMI1 input signal source.
HDMI2		Select HDMI2 input signal source.
DisplayPort		Select DisplayPort input signal source.
USB C		Select USB C input signal source.

PIP/PBP

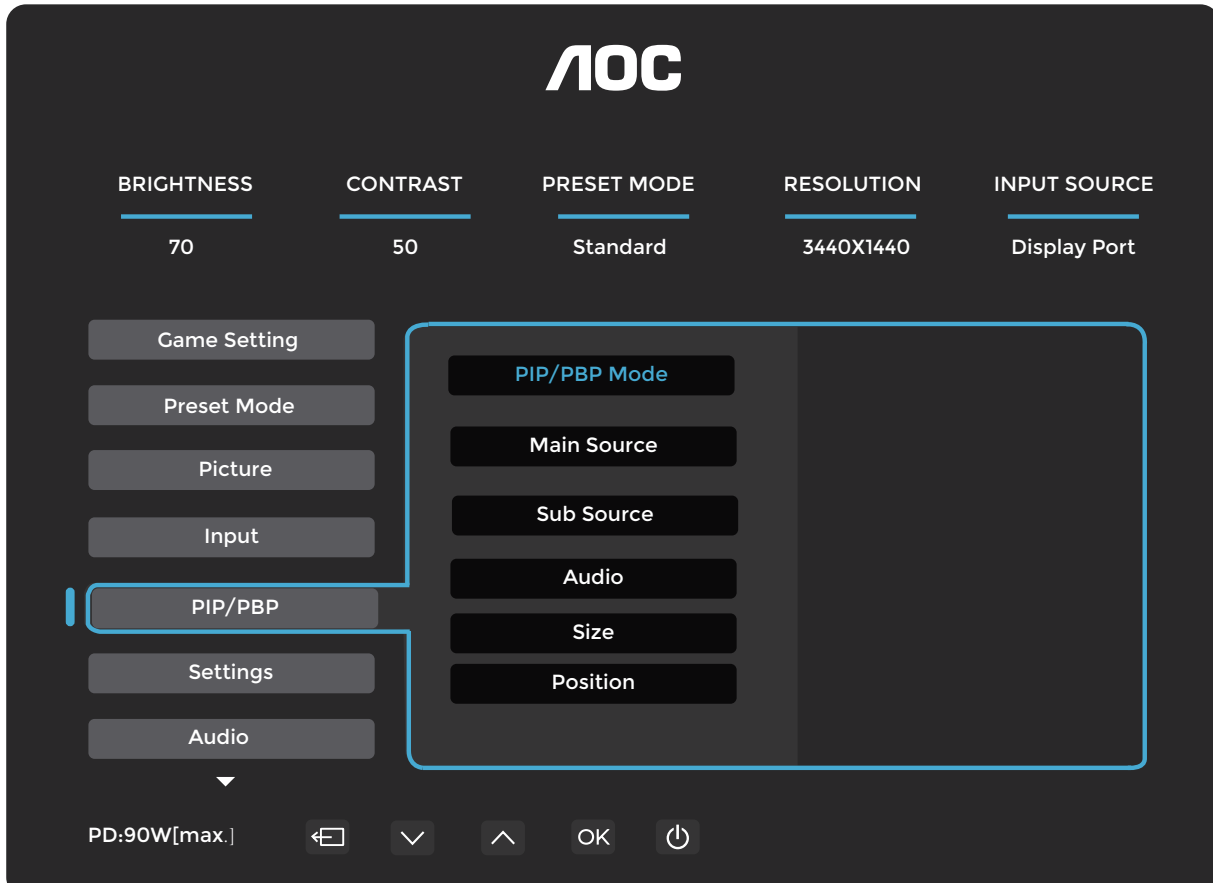

PIP/PBP Mode	Off / PIP / PBP	Disable or Enable PIP or PBP.
Main Source		Select main screen source.
Sub Source		Select sub screen source.
Audio	Main Source	Disable or Enable Audio Setup.
	Sub Source	
Size	Small / Middle / Large	Select screen size.
Position	Right-up	Set the screen location.
	Right-down	
	Left-up	
	Left-down	
Swap	On: Swap	Swap the screen source.
	Off: non action	

Note:

1) When "HDR" under "Brightness" is set to non-off state, all items under "PIP/PBP" cannot be adjusted.

2) When PBP/PIP is enabled, the main screen/secondary screen input source compatibility is as follows:

PBP		Main source			
		HDMI1	HDMI2	USB C	DisplayPort
Sub source	HDMI1	V	V	V	V
	HDMI2	V	V	V	V
	USB C	V	V	V	V
	DisplayPort	V	V	V	V

PIP		Main source			
		HDMI1	HDMI2	USB C	DisplayPort
Sub source	HDMI1	V	V	V	V
	HDMI2	V	V	V	V
	USB C	V	V	V	V
	DisplayPort	V	V	V	V

* : When PIP is enabled, if HDMI and DisplayPort are input as the primary screen source and secondary screen source at the same time, the other DisplayPort port supports a maximum of WQHD 60Hz 8bit(RGB or YCbCr 444 format or 420 format).

Settings

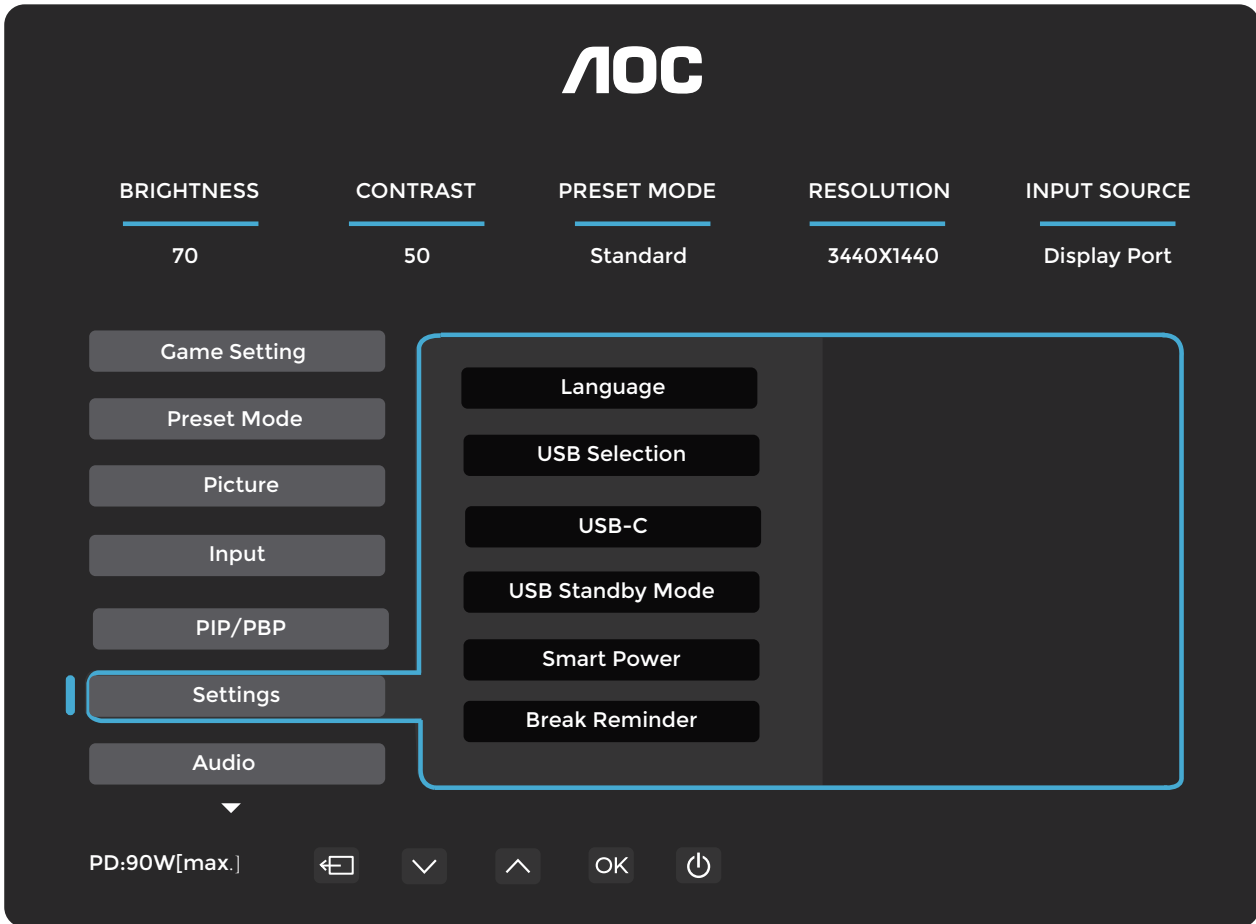

Language		Select the OSD language.
USB Selection	Auto / USB C / USB up	Select the path for USB Uplink Data
USB-C	High Data Speed/ High Resolution	If you want to connect USB-C device, please adjust the USB setting to High Resolution or High Data Speed.
USB Standby Mode	Off / On	
Smart Power	Off / On	
Break Reminder	Off /On	Break reminder if the user continuously works for more than 1 hrs.
Off Timer(hr)	0-24	Select DC off time.
DDC/CI	No / Yes	Turn On/Off DDC/CI Support.
Resolution Notice	Off / On	Optimal resolution prompt.
Reset	No / Yes	Reset the menu to default.
	ENERGY STAR® or No	ENERGY STAR® available for selective models

Audio

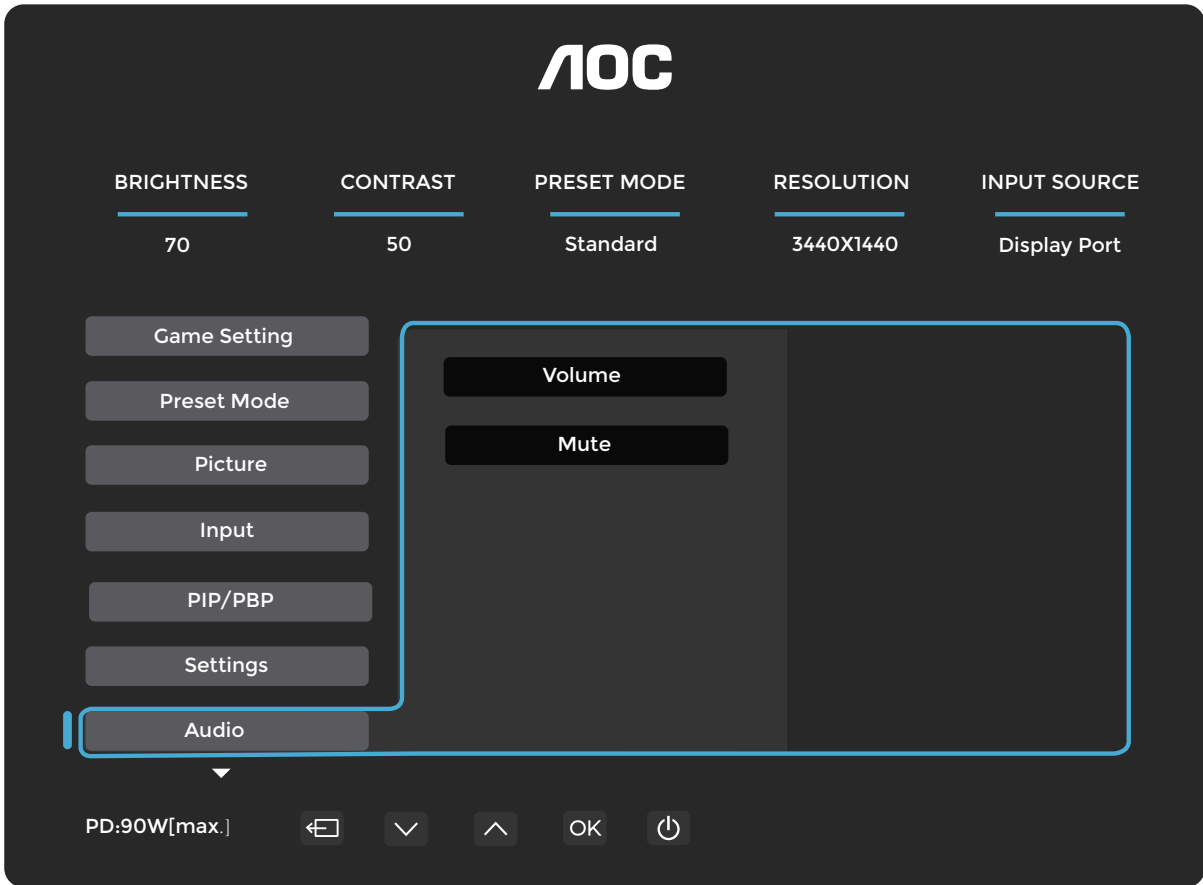

Volume	0-100	Volume Adjustment.
Mute	Off / On	Mute the volume.

OSD Setup

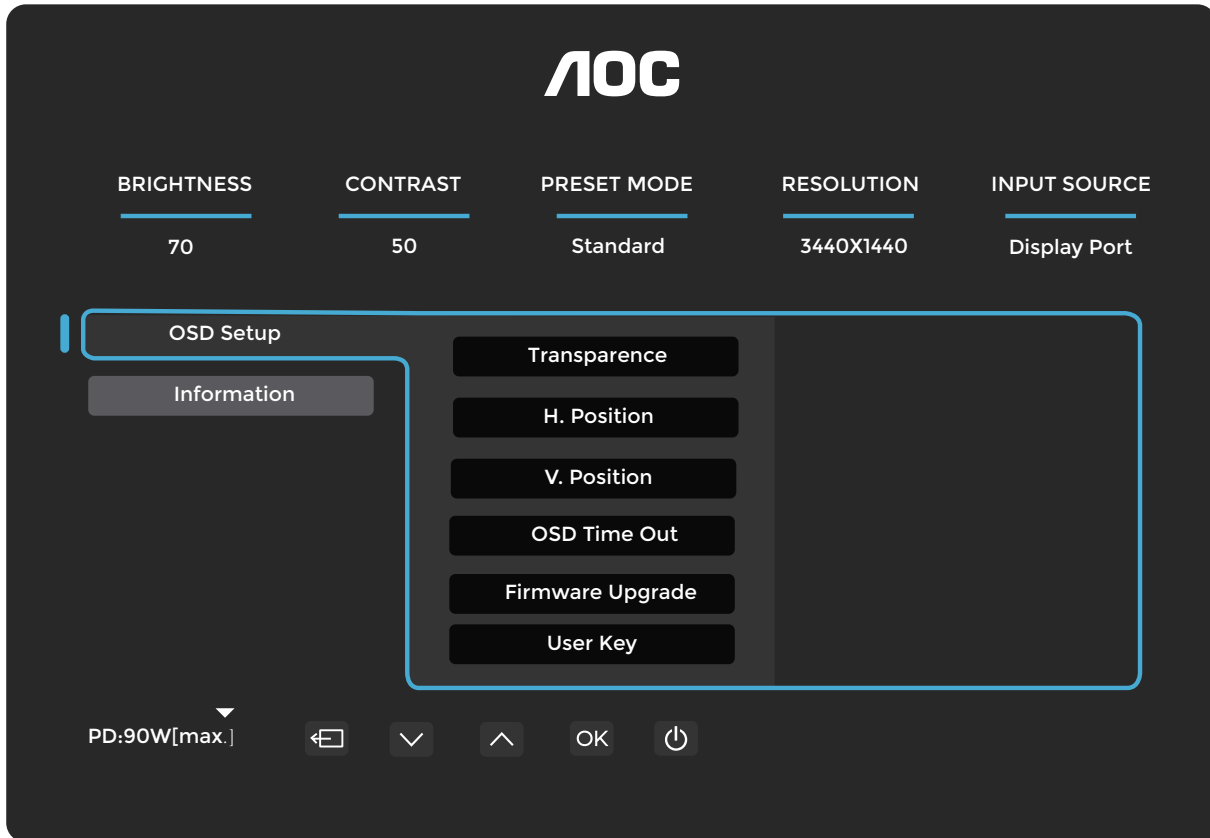

Transparence	0-100	Adjust the transparence of OSD.
H. Position	0-100	Adjust the horizontal position of OSD.
V. Position	0-100	Adjust the vertical position of OSD.
Timeout	5-120	Adjust the OSD Timeout.
Firmware Upgrade	No / Yes	Upgrade the FW via USB.
User Key	Color Space/ Preset Mode / Brightness / Volume/ Language/ Gamma/ Color Temp.	User set "V"key shortcut menu.

Information

AOC

BRIGHTNESS 70 CONTRAST 50 PRESET MODE Standard RESOLUTION 3440X1440 INPUT SOURCE Display Port

OSD Setup

Information

Input	HDMI2	SN	000000000
Resolution	3440x1440@60Hz	FW Version	V1.00
Brightness	70	Firmware Date	20250430
Gamma	2.2	Sync	Adaptive-Sync
HDR	SDR		
HBR2/HBR3	HBR		

PD:90W[max.] ⏪ ⏩ ⏴ ⏵ OK ⏻

LED Indicator

Status	LED Color
Full Power Mode	White
Active-off Mode	Orange

Troubleshoot

Problem & Question	Possible Solutions
Power LED Is Not ON	Make sure the power button is ON and the Power Cord is properly connected to a grounded power outlet and to the monitor.
No image on the screen	<ul style="list-style-type: none"> ● Is the power cord connected properly? Check the power cord connection and power supply. ● Is the video cable connected correctly? (Connected using the HDMI cable) Check the HDMI cable connection. (Connected using the DisplayPort cable) Check the DisplayPort cable connection. * HDMI/DisplayPort input is not available on every model. ● If the power is on, reboot the computer to see the initial screen (the login screen.) If the initial screen (the login screen) appears, boot the computer in the applicable mode (the safe mode for Windows 7/8/10) and then change the frequency of the video card. (Refer to the Setting the Optimal Resolution) If the initial screen (the login screen) does not appear, contact the Service Center or your dealer. ● Can you see "Input Not Supported" on the screen? You can see this message when the signal from the video card exceeds the maximum resolution and frequency that the monitor can handle properly. Adjust the maximum resolution and frequency that the monitor can handle properly. ● Make sure the AOC Monitor Drivers are installed.
Picture Is Fuzzy & Has Ghosting Shadowing Problem	Adjust the Contrast and Brightness Controls. Press hot-key (AUTO) to auto-adjust. Make sure you are not using an extension cable or switch box. We recommend plugging the monitor directly to the video card output connector on the back.
Picture Bounces, Flickers Or Wave Pattern Appears In The Picture	Move electrical devices that may cause electrical interference as far away from the monitor as possible. Use the maximum refresh rate your monitor is capable of at the resolution you are using.
Monitor Is Stuck In Active Off-Mode"	The Computer Power Switch should be in the ON position. The Computer Video Card should be snugly fitted in its slot. Make sure the monitor's video cable is properly connected to the computer. Inspect the monitor's video cable and make sure no pin is bent. Make sure your computer is operational by hitting the CAPS LOCK key on the keyboard while observing the CAPS LOCK LED. The LED should either turn ON or OFF after hitting the CAPS LOCK key.
Missing one of the primary colors (RED, GREEN, or BLUE)	Inspect the monitor's video cable and make sure that no pin is damaged. Make sure the monitor's video cable is properly connected to the computer.
Screen image is not centered or sized properly	Adjust H-Position and V-Position or press hot-key (AUTO).
Picture has color defects (white does not look white)	Adjust RGB color or select desired color temperature.
Horizontal or vertical disturbances on the screen	Use Windows 7/8/10/11 shut-down mode to adjust CLOCK and FOCUS. Press hot-key (AUTO) to auto-adjust.
Regulation & Service	Please refer to Regulation & Service Information which is in the CD manual or www.aoc.com (to find the model you purchase in your country and to find Regulation & Service Information in Support page).

Specification

General Specification

Panel	Model name	CU34E4CV		
	Driving system	TFT Color LCD		
	Viewable Image Size	86.4 cm diagonal		
	Pixel pitch	0.23175mm(H) x 0.23175mm(V)		
	Display Color	1.07B ^[1]		
Others	Horizontal scan range	30k~190kHz		
	Horizontal scan Size(Maximum)	797.22mm		
	Vertical scan range	48~120Hz		
	Vertical Scan Size(Maximum)	333.72mm		
	Optimal preset resolution	3440x1440@60Hz		
	Max resolution	3440x1440@100Hz(HDMI) 3440x1440@120Hz (DisplayPort/USB C)		
	Plug & Play	VESA DDC2B/CI		
	Power Source	100-240V~ 50/60Hz 2.5A		
	Power Consumption	Typical(default brightness and contrast)	37W	
		Max. (brightness = 100, contrast =100)	≤179W	
		Standby Mode	≤0.5W	
	Heat Dissipation	Normal Operation	126.28 BTU/hr (typ.)	
		Sleep (Standby mode)	<1.71 BTU/hr	
Off mode		<1.02 BTU/hr		
Off mode(AC switch)		0 BTU/hr		
USB C	USB-C	Double-sided Connectable Plug		
	Ultra-Highspeed	Data And Video Transmission		
	DisplayPort	Built-in DisplayPort Alt Mode		
	Power Supply	USB PD Version 3.0		
	Maximum Power Supply	Up to 90W ^[3] (5V/3A,7V/3A,9V/3A,10V/3A, 12V/3A,15V/3A, 20V/4.5A)		
Physical Characteristics	Connector Type	HDMIx2/DisplayPort/USB C/RJ45/USBx4/USB UP/Earphone out		
	RJ45	Ethernet LAN (10M/100M/1000M)		
	Signal Cable Type	Detachable		
	Built-In Speaker	5Wx2		
Environmental	Temperature	Operating	0°C~40°C	
		Non-Operating	-25°C~55°C	
	Humidity	Operating	10%~85% (Non-Condensing)	
		Non-Operating	5%~93% (Non-Condensing)	
	Altitude	Operating	0m~5000m (0ft~16404ft)	
		Non-Operating	0m~12192m (0ft~40000ft)	



Note:

[1]The maximum number of display colors supported by this product is 1.07 billion, and the setting conditions are as follows (there may be differences due to the output limitation of some graphics cards)

("V":support, "\":nonsupport):

Color Bit	Signal Version		Color Format		HDMI2.0		DisplayPort1.4		USBC@USB3.2		USBC@USB2.0	
	State	Color Format	YCbCr420	YCbCr444	YCbCr420	YCbCr444	YCbCr420	YCbCr444	YCbCr420	YCbCr444	YCbCr420	YCbCr444
			YCbCr422	RGB	YCbCr422	RGB	YCbCr422	RGB	YCbCr422	RGB	YCbCr422	RGB
WQHD 120Hz 10bits	\	\	V	V	\	\	V	V	\	\	V	V
WQHD 120Hz 8bits	\	\	V	V	V	\	V	V	\	\	V	V
WQHD 100Hz 10bits	\	\	V	V	V	\	V	V	\	\	V	V
WQHD 100Hz 8bits	V	V	V	V	V	\	V	V	\	\	V	V
Low Resolution 10 bpc	V	V	V	V	V	V	V	V	V	V	V	V
Low Resolution 8 bpc	V	V	V	V	V	V	V	V	V	V	V	V

[2] :DisplayPort1.4/HDMI2.0 signal input, in order to achieve WQHD 120Hz resolution of 1.07 billion colors and above, a DSC-capable graphics card is required. Check with your graphics card manufacturer for DSC support.

[3]: The USB C port supports a maximum output power of 90W, as detailed in the following table:

Smart Power Off	PD=65W 20V/3.25A	FULL
Smart Power On	PD=65W 20V/3.25A	USB > 10W
Smart Power On	PD=90W 20V/4.5A	USB ≤ 10W

Multi functional USB C interface, with a maximum output power of 90W. The output power may vary depending on the usage scenario, environment, or when connected to different models of laptops. The specific data is subject to the actual situation.

AOC Monitors Panel Pixel Defect Policy

AOC strives to deliver the highest quality products. We use some of the industry's most advanced manufacturing processes and practice stringent quality control. However, pixel or sub pixel defects on the Monitor panels used in the monitors are sometimes unavoidable.

No manufacturer can guarantee that all panels will be free from pixel defects, but AOC guarantees that any monitor with an unacceptable number of defects will be repaired or replaced under warranty. This notice explains the different types of pixel defects and defines acceptable defect levels for each type. In order to qualify for repair or replacement under warranty, the number of pixel defects on a Monitor panel must exceed these acceptable levels. For example, no more than 0.0004% of the sub pixels on a monitor may be defective.

Furthermore, AOC sets even higher quality standards for certain types or combinations of pixel defects that are more noticeable than others. This policy is valid worldwide.

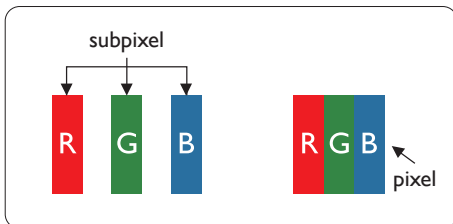

Pixels and Sub pixels

A pixel, or picture element, is composed of three sub pixels in the primary colors of red, green and blue. Many pixels together form an image. When all sub pixels of a pixel are lit, the three colored sub pixels together appear as a single white pixel. When all are dark, the three colored sub pixels together appear as a single black pixel. Other combinations of lit and dark sub pixels appear as single pixels of other colors.

Types of Pixel Defects

Pixel and sub pixel defects appear on the screen in different ways. There are two categories of pixel defects and several types of sub pixel defects within each category.

Bright Dot Defects

Bright dot defects appear as pixels or sub pixels that are always lit or 'on'. That is, a bright dot is a sub-pixel that stands out on the screen when the monitor displays a dark pattern. There are the types of bright dot defects.

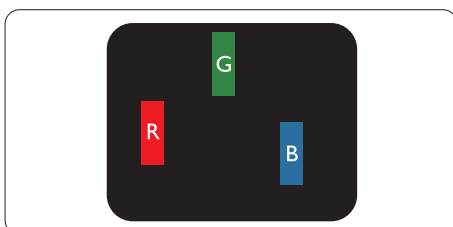

One lit red, green or blue sub pixel.

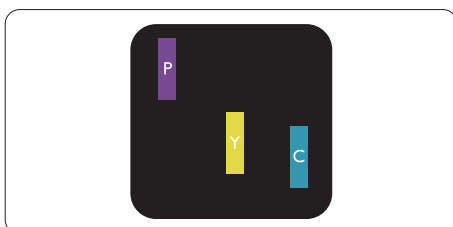

Two adjacent lit sub pixels:

- Red + Blue = Purple
- Red + Green = Yellow
- Green + Blue = Cyan (Light Blue)

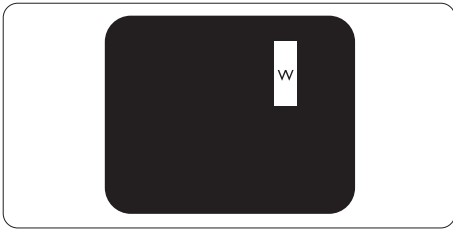

Three adjacent lit sub pixels (one white pixel).

Note

A red or blue bright dot must be more than 50 percent brighter than neighboring dots while a green bright dot is 30 percent brighter than neighboring dots.

Black Dot Defects

Black dot defects appear as pixels or sub pixels that are always dark or 'off'. That is, a dark dot is a sub-pixel that stands out on the screen when the monitor displays a light pattern. These are the types of black dot defects.

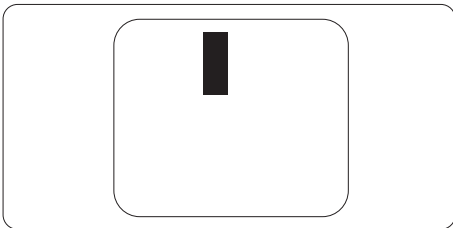

Proximity of Pixel Defects

Because pixel and sub pixels defects of the same type that are near to one another may be more noticeable, AOC also specifies tolerances for the proximity of pixel defects.

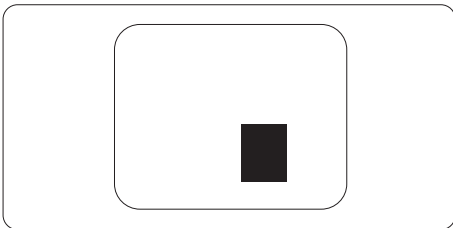

Pixel Defect Tolerances

In order to qualify for repair or replacement due to pixel defects during the warranty period, a Monitor panel in a AOC panel monitor must have pixel or sub pixel defects exceeding the tolerances listed in the web manual.

BRIGHT DOT DEFECTS	ACCEPTABLE LEVEL
1 lit subpixel	2
2 adjacent lit subpixels	1
3 adjacent lit subpixels (one white pixel)	0
Distance between two bright dot defects*	$\geq 15\text{mm}$
Total bright dot defects of all types	2
BLACK DOT DEFECTS	ACCEPTABLE LEVEL
1 dark subpixel	5 or fewer
2 adjacent dark subpixels	2 or fewer
3 adjacent dark subpixels	≤ 1
Distance between two black dot defects*	$\geq 15\text{mm}$
Total black dot defects of all types	5 or fewer
TOTAL DOT DEFECTS	ACCEPTABLE LEVEL
Total bright or black dot defects of all types	5 or fewer

Note

*: 1 or 2 adjacent sub pixel defects = 1 dot defect.

Preset Display Modes

STANDARD	RESOLUTION(±1Hz)	HORIZONTAL FREQUENCY(KHz)	VERTICAL FREQUENCY(Hz)
VGA	640x480@60Hz	31.469	59.94
	640x480@67Hz	35	67
	640x480@72Hz	37.861	72.809
	640x480@75Hz	37.5	75
SVGA	800x600@56Hz	35.156	56.25
	800x600@60Hz	37.879	60.317
	800x600@72Hz	48.077	72.188
	800x600@75Hz	46.875	75
XGA	1024x768@60Hz	48.363	60.004
	1024x768@70Hz	56.476	70.069
	1024x768@75Hz	60.023	75.029
WXGA+	1440x900@60Hz	55.935	59.887
	832x624@75Hz	49.725	74.77
	1680x1050@60Hz	64.674	59.883
Full HD	1920x1080@60Hz	67.5	60
SXGA	1280x1024@60Hz	63.981	60.02
	1280x1024@75Hz	79.976	75.025
	1280x720@60Hz	44.772	59.855
	1280x960@60Hz	60	60
	2560x1080@60Hz	67.173	59.976
QHD	2560x1440@120Hz	176.4	120
WQHD	3440x1440@60Hz	88.861	60
	3440x1440@100Hz	149	100
	3440x1440@30Hz	44.43	30
	3440x1440@75Hz	111.9	75
	3440x1440@120Hz (DisplayPort/USB C)	176.4	120

Note: According to the VESA standard, there may be a certain error (+/-1Hz) when calculating the refresh rate (field frequency) of different operating systems and graphics cards. In order to improve compatibility, the nominal refresh rate of this product has been rounded off. Please refer to the actual product.

Recommendations to prevent Computer Vision Syndrome (CVS)

(Only applicable to the model of application)

AOC monitors are designed with TÜV Rheinland® EyeComfort 3.0 to prevent eyestrain caused by prolonged computer use. This advanced four-star rating standard ensures reduced visual fatigue through a combination of hardware and design features which are enabled by default on your monitor.

Easy-on-eyes features:

- **Anti-glare screen:** The matte anti-glare coating minimizes reflections from ambient lighting sources such as windows or overhead lamps, reducing visual distractions and improving screen clarity.
- **Flicker-free technology:** Utilizes direct current (DC) backlight control to maintain consistent brightness levels in order to eliminate screen flickering — a common source of eye fatigue.
- **LowBlue mode:** This monitor reduces harmful blue light exposure from less than 50 percent to under 35 percent, helping to protect your eyes without compromising color quality. The low blue light feature is set to be the default factory setting to comply with TÜV Rheinland's hardware low blue light certification.
- **Reading mode:** Reading mode provides a paper-like reading experience that is best suited for reviewing long documents, articles or eBooks. This allows a more natural and comfortable reading experience by adjusting the contrast, brightness and color temperature thereby reducing eye strain during extended reading sessions.

To reduce eye fatigue and enhance productivity, follow these best practices when setting up your workstation:

- **Optimize Ergonomics:** Position your desk and chair so that your feet rest flat on the floor, your eyes are approximately one arm's length from the screen, and your hands can rest comfortably on the keyboard and mouse. Your eye level should be five to seven cm (two to three inches) below the top edge of the monitor. If you wear bifocal or progressive lenses, adjust the monitor height to minimize head tilting.
- **Maintain Healthy Viewing Distance:** Keep a distance of **50 to 70 centimeters (20 to 28 inches)** between your eyes and the screen. Prolonged screen exposure can cause eye fatigue and may impact vision. To reduce strain, **rest your eyes for five to ten minutes** after every hour of screen use. Regularly shifting your focus to distant objects can also help relax your eye muscles.
- **Adjust Display Settings:** Choose the most suitable monitor mode for your tasks, or manually adjust the brightness and contrast to your comfort level.
- **Manage Lighting:** Ensure that your screen is free from glare or reflections caused by overhead lights or windows. Match the lighting behind the monitor to the screen's brightness, particularly when displaying light backgrounds. Avoid fluorescent lights and highly reflective surfaces.
- **Build Healthy Work Habits:** Blink often and maintain good eye care practices to help prevent dryness and discomfort. Frequent, shorter breaks are more effective than fewer, longer ones in maintaining visual comfort throughout the day.
- **Practice Eye and Neck Exercises:** Periodically focus on distant objects to reduce eye strain. Close your eyes and gently roll them in circles. To release tension, stretch your neck by slowly tilting your head forward, backward, and side to side.

Pin Assignments



19-Pin Color Display Signal Cable

Pin No.	Signal Name	Pin No.	Signal Name	Pin No.	Signal Name
1.	TMDS Data 2+	9.	TMDS Data 0-	17.	DDC/CEC Ground
2.	TMDS Data 2 Shield	10.	TMDS Clock +	18.	+5V Power
3.	TMDS Data 2-	11.	TMDS Clock Shield	19.	Hot Plug Detect
4.	TMDS Data 1+	12.	TMDS Clock-		
5.	TMDS Data 1Shield	13.	CEC		
6.	TMDS Data 1-	14.	Reserved (N.C. on device)		
7.	TMDS Data 0+	15.	SCL		
8.	TMDS Data 0 Shield	16.	SDA		

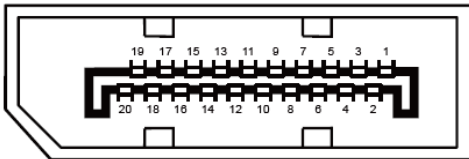

20-Pin Color Display Signal Cable

Pin No.	Signal Name	Pin No.	Signal Name
1	ML_Lane 3 (n)	11	GND
2	GND	12	ML_Lane 0 (p)
3	ML_Lane 3 (p)	13	CONFIG1
4	ML_Lane 2 (n)	14	CONFIG2
5	GND	15	AUX_CH(p)
6	ML_Lane 2 (p)	16	GND
7	ML_Lane 1 (n)	17	AUX_CH(n)
8	GND	18	Hot Plug Detect
9	ML_Lane 1 (p)	19	Return DP_PWR
10	ML_Lane 0 (n)	20	DP_PWR

Plug and Play

Plug & Play DDC2B Feature

This monitor is equipped with VESA DDC2B capabilities according to the VESA DDC STANDARD. It allows the monitor to inform the host system of its identity and, depending on the level of DDC used, communicate additional information about its display capabilities.

The DDC2B is a bi-directional data channel based on the I2C protocol. The host can request EDID information over the DDC2B channel.

