

AOC GAMING



As an OLED product, this display needs regular screen maintenance to reduce the risk of image retention (burn-in).

USER MANUAL

Q27G41ZDF

AOC GAMING MONITOR

Safety	1
National Conventions.....	1
Power	2
Installation	3
Cleaning.....	4
Other	5
Setup.....	6
Contents in Box.....	6
Set-up Stand & Base.....	7
Adjusting Viewing Angle.....	8
Connecting the Monitor	9
Wall Mounting	10
Adaptive-Sync function.....	11
HDR.....	12
Adjusting.....	13
Hotkeys.....	13
OSD Setting	14
Game Setting.....	15
Picture	17
PIP/PBP	20
OLED Setting	22
Settings.....	24
Audio	25
OSD Setup.....	26
Information.....	27
LED Indicator	28
Troubleshoot.....	29
Specification	30
General Specification.....	30
AOC Monitors Panel Pixel Defect Policy.....	32
Preset Display Modes.....	35
Pin Assignments.....	36
Plug and Play.....	37

Safety

National Conventions

The following subsections describe national conventions used in this document.

Notes, Cautions, and Warnings

Throughout this guide, blocks of text may be accompanied by an icon and printed in bold type or in italic type. These blocks are notes, cautions, and warnings, and they are used as follows:



NOTE: A NOTE indicates important information that helps you make better use of your computer system.





CAUTION: A CAUTION indicates either potential damage to hardware or loss of data and tells you how to avoid the problem.



WARNING: A WARNING indicates the potential for bodily harm and tells you how to avoid the problem. Some warnings may appear in alternate formats and may be unaccompanied by an icon. In such cases, the specific presentation of the warning is mandated by regulatory authority.

Power

 The monitor should be operated only from the type of power source indicated on the label. If you are not sure of the type of power supplied to your home, consult your dealer or local power company.

 The monitor is equipped with a three-pronged grounded plug, a plug with a third (grounding) pin. This plug will fit only into a grounded power outlet as a safety feature. If your outlet does not accommodate the three-wire plug, have an electrician install the correct outlet, or use an adapter to ground the appliance safely. Do not defeat the safety purpose of the grounded plug.

 Unplug the unit during a lightning storm or when it will not be used for long periods of time. This will protect the monitor from damage due to power surges.

 Do not overload power strips and extension cords. Overloading can result in fire or electric shock.

 To ensure satisfactory operation, use the monitor only with UL listed computers which have appropriate configured receptacles marked between 100-240V AC, Min. 5A.

 The wall socket shall be installed near the equipment and shall be easily accessible.

Installation

! Do not place the monitor on an unstable cart, stand, tripod, bracket, or table. If the monitor falls, it can injure a person and cause serious damage to this product. Use only a cart, stand, tripod, bracket, or table recommended by the manufacturer or sold with this product. Follow the manufacturer's instructions when installing the product and use mounting accessories recommended by the manufacturer. A product and cart combination should be moved with care.

! Never push any object into the slot on the monitor cabinet. It could damage circuit parts causing a fire or electric shock. Never spill liquids on the monitor.

! Do not place the front of the product on the floor.

! If you mount the monitor on a wall or shelf, use a mounting kit approved by the manufacturer and follow the kit instructions.

! Leave some space around the monitor as shown below. Otherwise, air-circulation may be inadequate hence overheating may cause a fire or damage to the monitor.

! To avoid potential damage, for example the panel peeling from the bezel, ensure that the monitor does not tilt downward by more than -5 degrees. If the -5 degree downward tilt angle maximum is exceeded, the monitor damage will not be covered under warranty.

See below the recommended ventilation areas around the monitor when the monitor is installed on the wall or on the stand:

Installed with stand

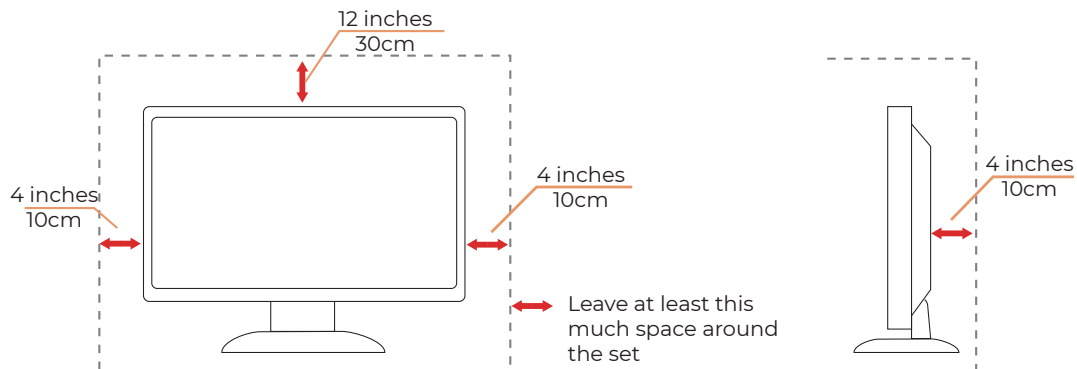

Cleaning

⚠ Clean the cabinet regularly with a water-dampened, soft cloth.

⚠ When cleaning use a soft cotton or microfiber cloth. The cloth should be damp and almost dry, do not allow liquid into the case.



⚠ Please disconnect the power cord before cleaning the product.

Other

 If the product is emitting a strange smell, sound or smoke, disconnect the power plug IMMEDIATELY and contact a Service Center.

 Make sure that the ventilating openings are not blocked by a table or curtain.

 Do not engage the OLED monitor in severe vibration or high impact conditions during operation.

 Do not knock or drop the monitor during operation or transportation.

 It is not recommended to use this OLED product for more than four continuous hours. Possible image retention (burn-in) may occur beyond this usage duration. To reduce the probability of image retention this product uses a number of technologies A maintenance cycle takes about 10 minutes. For details, refer to the "Screen Maintenance" section.

 Low Blue Light: The display uses the low blue light panel. It complies with TÜV Rheinland Low Blue Light Hardware Solution certification under factory reset/default setting.

Health:

•The monitor should be 50 ~ 70 cm (20 ~ 28 inches) away from your eyes.

•Looking at the screen for an extended period of time causes eye fatigue and may deteriorate your eyesight.

Rest your eyes for 5 ~ 10 minutes for every 1 hour of product use.

•Reduce your eye strain by focusing on objects far way.

•Frequent blinking and eye exercise help keep your eyes from drying out.

 Flicker-free technology maintains a stable backlight with a DC dimmer that eliminates the primary cause of monitor flicker, making it easier on the eyes.

Setup

Contents in Box

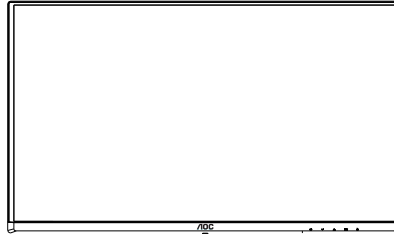

Monitor

*



Quick Start Guide

*



Warranty Card



Stand

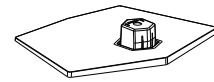

Base



Power Cable

*



HDMI Cable

*



DisplayPort Cable

*Not all signal cables will be provided for all countries and regions. Please check with the local dealer or AOC branch office for confirmation.

Set-up Stand & Base

Please setup or remove the base following the steps as below.

Setup:

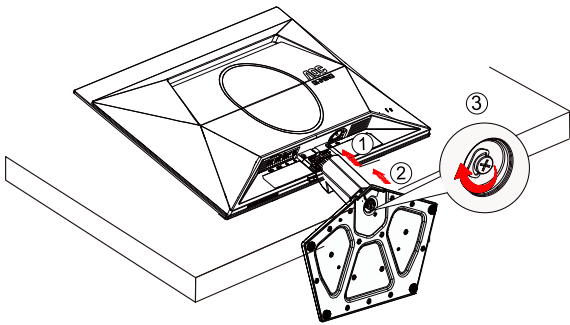

Remove:

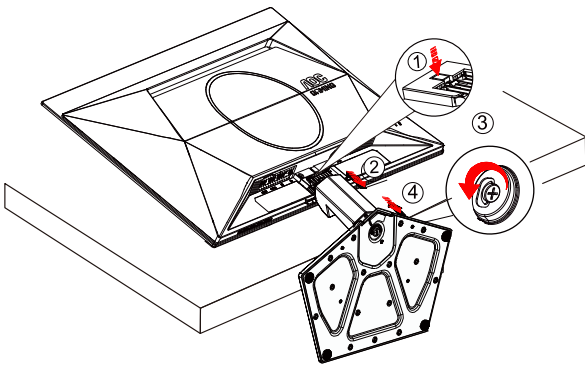

 **NOTE:** Display design may differ from those illustrated.

Adjusting Viewing Angle

To achieve the best viewing experience, it is recommended that the user can make sure they are able to look at their whole face on the screen, then adjust the monitor's angle based on personal preference. Hold the stand so you will not topple the monitor when you change the monitor's angle. You are able to adjust the monitor as below:

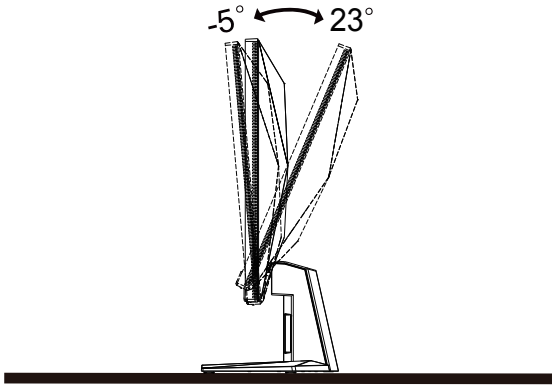

NOTE:

Do not touch the OLED screen when you change the angle. Touching the OLED screen may cause damage.

Warning

- To avoid potential screen damage, such as panel peeling, ensure that the monitor does not tilt downward by more than -5 degrees.
- Do not press the screen while adjusting the angle of the monitor. Grasp only the bezel.

Connecting the Monitor

Cable Connections In Back of Monitor and Computer:

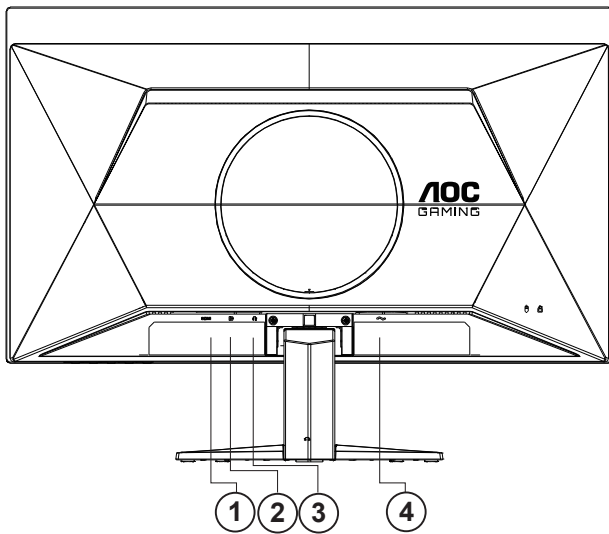

1. HDMI
2. DisplayPort
3. Earphone
4. Power

Connect to PC

1. Connect the power cord to the back of the display firmly.
2. Turn off your computer and unplug its power cable.
3. Connect the display signal cable to the video connector on the back of your computer.
4. Plug the power cord of your computer and your display into a nearby outlet.
5. Turn on your computer and display.

If your monitor displays an image, installation is complete. If it does not display an image, please refer to Troubleshoot.

To protect equipment, always turn off the PC and OLED monitor before connecting.

Wall Mounting

Preparing to Install An Optional Wall Mounting Arm.

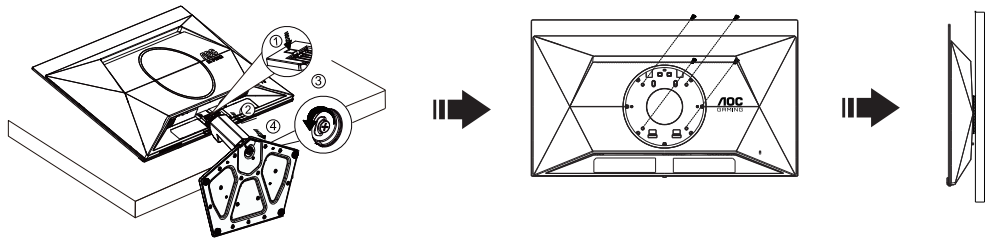

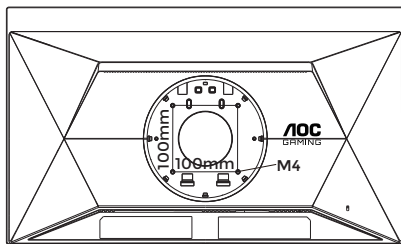

This monitor can be attached to a wall mounting arm you purchase separately. Disconnect power before this procedure. Follow these steps:

1. Remove the base.
2. Follow the manufacturer's instructions to assemble the wall mounting arm.
3. Place the wall mounting arm onto the back of the monitor. Line up the holes of the arm with the holes in the back of the monitor.
4. Insert the 4 screws into the holes and tighten.
5. Reconnect the cables. Refer to the user's manual that came with the optional wall mounting arm for instructions on attaching it to the wall.

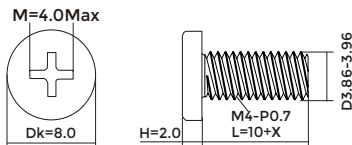

Specification of wall hanger screws: M4*(10+X)mm (X=Thickness of Wall mount bracket)



 **Note:** VESA mounting screw holes are not available for all models, please check with the dealer or official department of AOC. Always contact manufacturer for wall-mount installation.

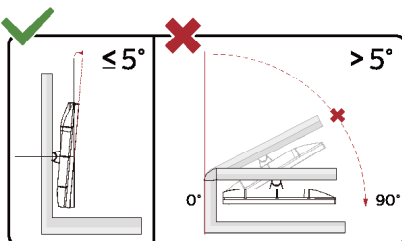

* Display design may differ from those illustrated.

WARNING:

1. To avoid potential screen damage, such as panel peeling, ensure that the monitor does not tilt downward by more than -5 degrees.
2. Do not press the screen while adjusting the angle of the monitor. Grasp only the bezel.

Adaptive-Sync function

1. Adaptive-Sync function works with DisplayPort/HDMI
2. Compatible Graphics Card: Recommended list is as below, also could be checked by visiting www.AMD.com

Graphics Cards

- Radeon™ RX Vega series
- Radeon™ RX 500 series
- Radeon™ RX 400 series
- Radeon™ R9/R7 300 series (R9 370/X, R7 370/X, R7 265 except)
- Radeon™ Pro Duo (2016)
- Radeon™ R9 Nano series
- Radeon™ R9 Fury series
- Radeon™ R9/R7 200 series (R9 270/X, R9 280/X except)

Processors

- AMD Ryzen™ 7 2700U
- AMD Ryzen™ 5 2500U
- AMD Ryzen™ 5 2400G
- AMD Ryzen™ 3 2300U
- AMD Ryzen™ 3 2200G
- AMD PRO A12-9800
- AMD PRO A12-9800E
- AMD PRO A10-9700
- AMD PRO A10-9700E
- AMD PRO A8-9600
- AMD PRO A6-9500
- AMD PRO A6-9500E
- AMD PRO A12-8870
- AMD PRO A12-8870E
- AMD PRO A10-8770
- AMD PRO A10-8770E
- AMD PRO A10-8750B
- AMD PRO A8-8650B
- AMD PRO A6-8570
- AMD PRO A6-8570E
- AMD PRO A4-8350B
- AMD A10-7890K
- AMD A10-7870K
- AMD A10-7850K
- AMD A10-7800
- AMD A10-7700K
- AMD A8-7670K
- AMD A8-7650K
- AMD A8-7600
- AMD A6-7400K

HDR

It is compatible with input signals in HDR10 format.

The display may automatically activate the HDR function if the player and content are compatible. Please contact the device manufacturer and the content provider for information on the compatibility of your device and content. Please select "OFF" for the HDR function when you have no need for automatic activation function.

Note:

1. No special setting is needed for the DisplayPort/HDMI interface in WIN10 versions lower (older) than V1703.
2. Only the HDMI interface is available and the DisplayPort interface cannot function in WIN10 version V1703.
3. 3840x2160@50Hz/60Hz/120Hz only suggest for Blu-ray Player, Xbox and PlayStation.
4. Display Setting:
 - a. The display resolution is set to 2560*1440, and HDR is preset to ON.
 - b. After entering an application, the best HDR effect can be achieved when the resolution is changed to 2560*1440 (if available).

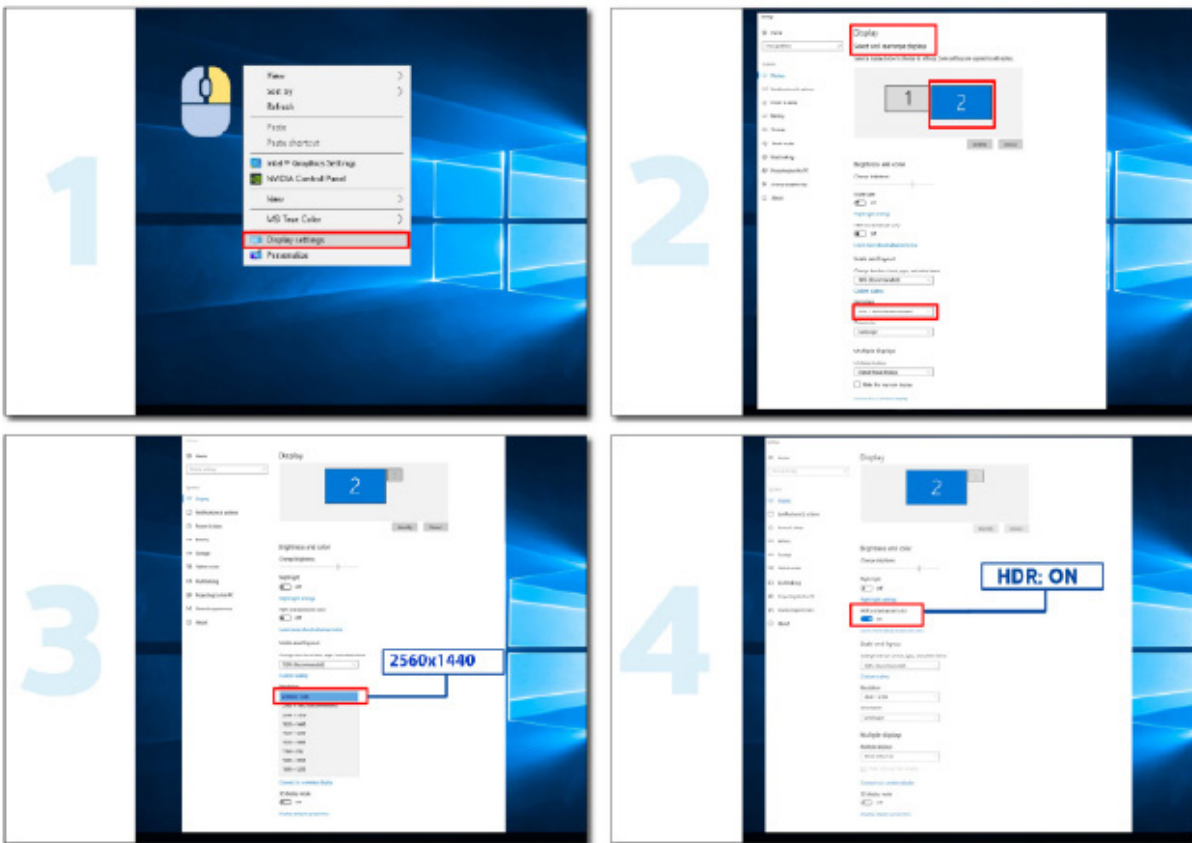

Adjusting

Hotkeys

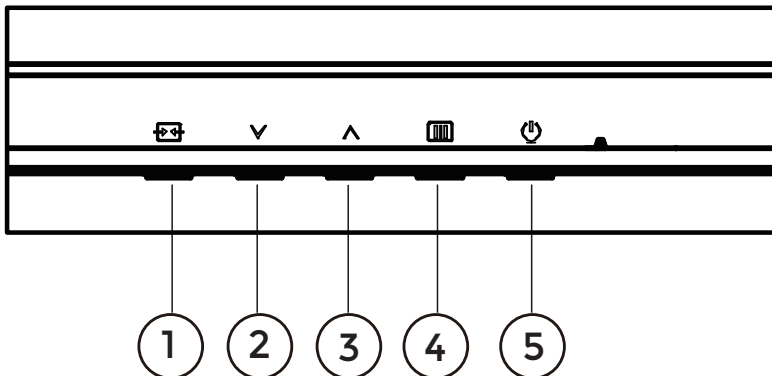

1	Source/Exit
2	User Custom Key (Game Mode)/ Decrease
3	Dial Point
4	Menu/Enter
5	Power

Menu/Enter

Press to display the OSD or confirm the selection.

Power

Press the Power button to turn on the monitor.

Dial Point

When there is no OSD, press Dial Point button to show / hide Dial Point.

User Custom Key (Game Mode)/Decrease

Customize this shortcut key function in OSD menu: Game Mode, Sniper Scope, Frame Counter. The factory default is Game Mode.

When there is no OSD, press “∨” key to open Gaming mode function, then press “∨” or “∧” key to select Gaming mode (Standard, FPS, RTS, Racing, Gamer 1, Gamer 2 or Gamer 3) basing on the different game types.

Source/Exit





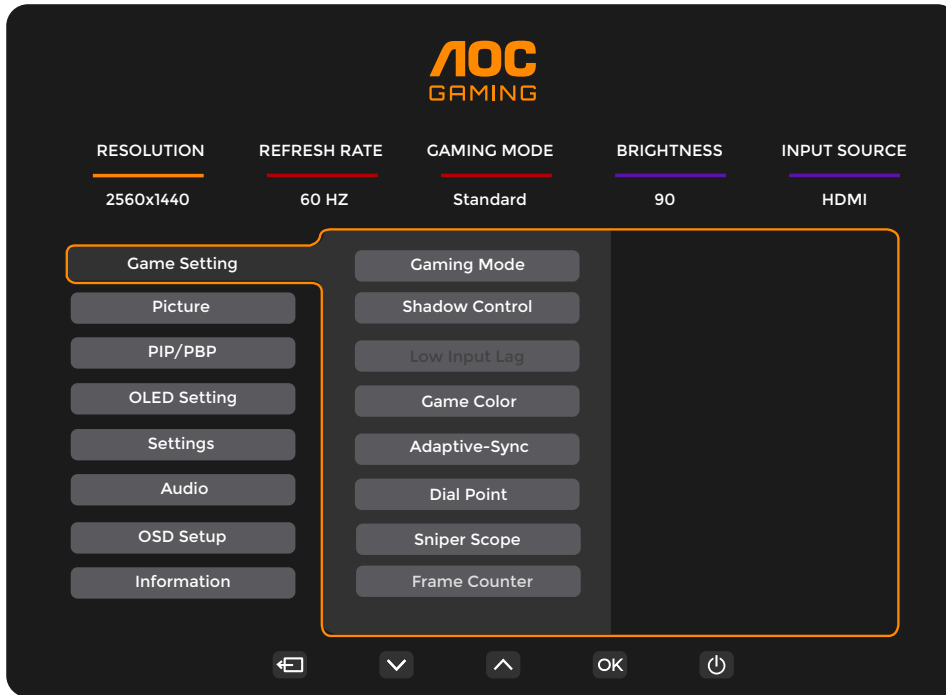

When the OSD is closed, press Source/Exit button will be Source hot key function.

When the OSD menu is active, this button acts as an exit key (to exit the OSD menu).

OSD Setting

Basic and simple instruction on the control keys.



- 1). Press the  **MENU-button** to activate the OSD window.
- 2). Press \downarrow or \uparrow to navigate through the functions. Once the desired function is highlighted, press the  **MENU-button / OK** to activate it, press \downarrow or \uparrow to navigate through the sub-menu functions. Once the desired sub-menu function is highlighted, press  **MENU-button / OK** to activate it.
- 3). Press \downarrow or \uparrow to change the settings of the selected function. Press \leftarrow / \rightarrow to exit. If you want to adjust any other function, repeat steps 2-3.
- 4). OSD Lock Function: To lock the OSD, press and hold the  MENU-button while the monitor is off and then press  power button to turn the monitor on. To unlock the OSD - press and hold the  MENU-button while the monitor is off and then press  power button to turn the monitor on.

Notes:

- 1). If the product has only one signal input, the item of "Input Select" is unable to be adjusted.
- 2). If the input signal resolution is the native resolution or Adaptive-Sync, then the item "Image Ratio" is invalid.

Game Setting

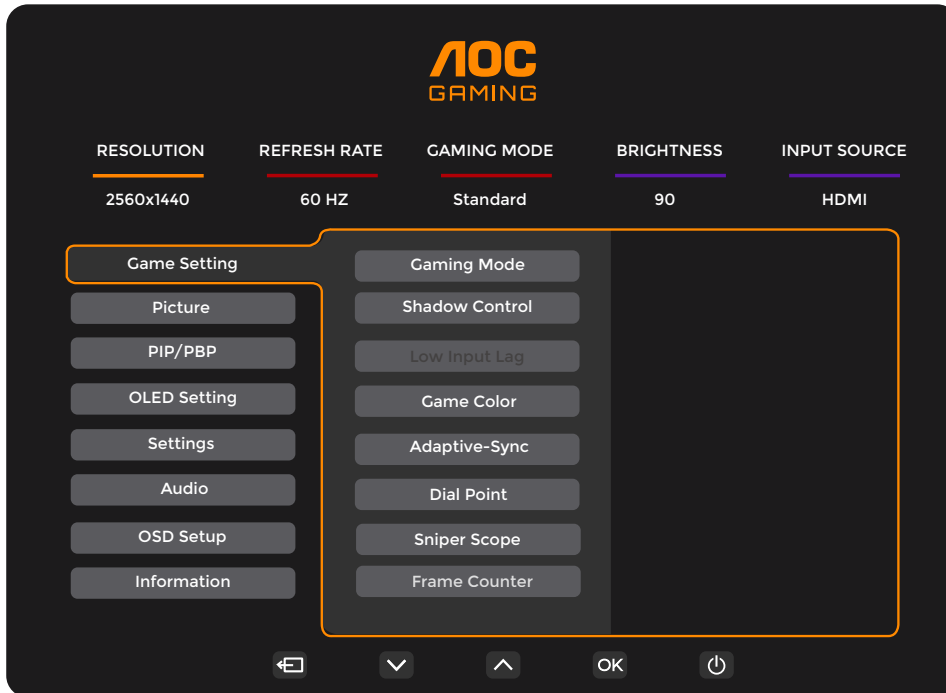

Gaming Mode	Standard	Enhance readability for suitable web and mobile games.
	FPS	For playing FPS (first Person Shooters) games. Improves black level in dark theme.
	RTS	For playing RTS (Real Time Strategy) games. Improves the image quality.
	Racing	For playing Racing games, Provides fastest response time and high color saturation.
	Gamer 1	User's preference settings saved as Gamer 1.
	Gamer 2	User's preference settings saved as Gamer 2.
	Gamer 3	User's preference settings saved as Gamer 3.
Shadow Control	0 ~ 20	Shadow Control Default is 0, then end-user can adjust from 0 to 20 increase for a clearer picture. If picture is too dark to be saw the detail clearly, adjusting from 0 to 20 for a clear picture.
Low Input Lag	Off / On	Turn off frame buffer to decrease input lag.
Game Color	0 ~ 20	Game Color will provide 0-20 level for adjusting saturation to get a better picture.
Adaptive-Sync	Off / On	Disable or Enable Adaptive-Sync. Adaptive-Sync Run Reminder: When the Adaptive-Sync feature is enabled, there may be flashing in some game environments.
Dial Point	Off / On / Dynamic	The "Dial Point" function places an aiming indicator in the center of screen for helping gamers to play First Person Shooter (FPS) games with accurate and precise aiming.
Sniper Scope	Off / 1 / 1.5 / 2.0	Zoom in locally to make it easier to target when shooting.
Frame Counter	Off / Right-up / Right-Down / Left-Up / Left-Down	Display V frequency on the corner selected.

Note:

- 1). When under "Picture", the "HDR Mode" is set to the non-off state, "Shadow Control" and "Game Color" items cannot be adjusted.

- 2). When under "Picture", the "HDR" is set to "DisplayHDR", in options "Game Mode", "Shadow Control", "Game Color", "Sniper Scope", and "Overdrive", items such as "Extreme" cannot be adjusted or selected.
- 3). When under "Picture", the "HDR" is set to "HDR Peak", "HDR Picture", "HDR Movie" and "HDR Game", in options "Game Mode", "Game Color" cannot be adjusted or selected.
- 4). When under "Picture", "Color Gamut" is set to "sRGB" or "DCI-P3", in options "Shadow Control", "Game Color", cannot be adjusted or selected.

Picture

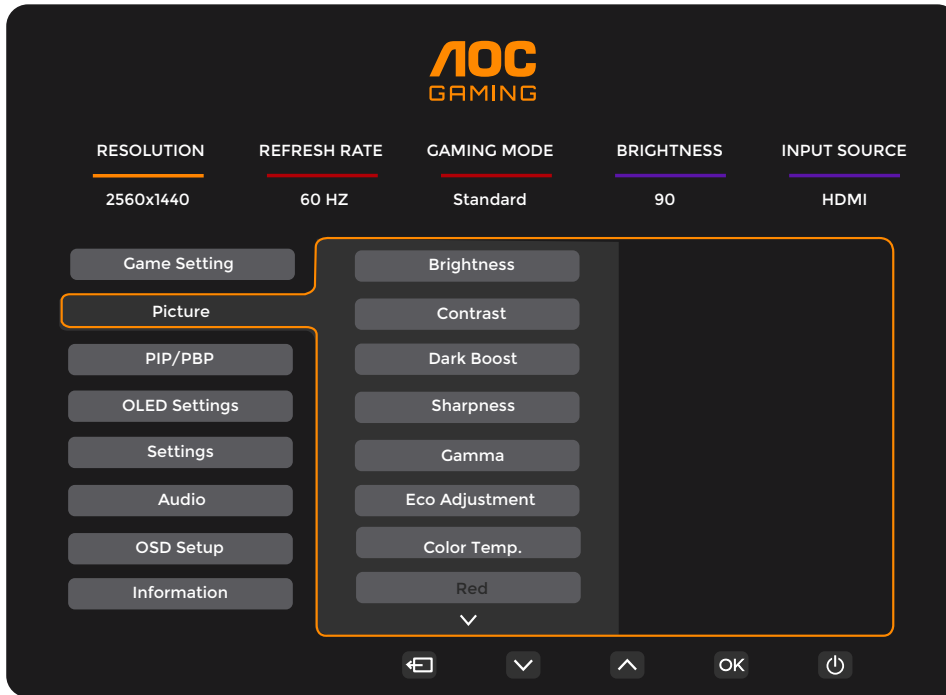

Brightness	0-100	Backlight Adjustment.
Contrast	0-100	Contrast from Digital-register.
Dark Boost	Off / Level 1 / Level 2 / Level 3	Enhance the screen details in the dark or bright area to adjust the brightness in the bright area and ensure that it is not oversaturated.
Sharpness	0-100	Adjust Sharpness.
Gamma	1.8 / 2.0 / 2.2 / 2.4 / 2.6	Adjust Gamma.
Eco Adjustment	Standard	Standard Mode.
	Text	Text Mode.
	Internet	Internet Mode.
	Game	Game Mode.
	Movie	Movie Mode.
	Sports	Sports Mode.
	Reading	Reading Mode.
Color Temp.	Warm	Warm Color Temperature .
	Normal	Normal Color Temperature .
	Cool	Cool Color Temperature.
	User	Restore Color Temperature .
Red	0-100	Red gain from Digital-register.
Green	0-100	Green gain from Digital-register.
Blue	0-100	Blue gain from Digital-register.

R.Saturation	0-100	Adjust R.Saturation.
G.Saturation	0-100	Adjust G.Saturation.
B.Saturation	0-100	Adjust B.Saturation.
C.Saturation	0-100	Adjust C.Saturation.
M.Saturation	0-100	Adjust M.Saturation.
Y.Saturation	0-100	Adjust Y.Saturation.
R.Hue	0-100	Adjust R.Hue.
G.Hue	0-100	Adjust G.Hue.
B.Hue	0-100	Adjust B.Hue.
C.Hue	0-100	Adjust C.Hue.
M.Hue	0-100	Adjust M.Hue.
Y.Hue	0-100	Adjust Y.Hue.
HDR	Off	Set the HDR profile according to your usage requirements. Note: When HDR is detected, the HDR option is displayed for adjustment.
	DisplayHDR	
	HDR Peak	
	HDR Picture	
	HDR Movie	
	HDR Game	
HDR Mode	Off	Optimized for the color and contrast of the picture, which will simulate showing the HDR effect. Note: When HDR is not detected, the HDR Mode option is displayed for adjustment.
	HDR Picture	
	HDR Movie	
	HDR Game	
Color Space	Panel Native	Standard color space panel.
	sRGB	sRGB Color space.
	DCI-P3	DCI-P3 Color space.
LowBlue Mode	Off	Decrease blue light wave by controlling color temperature.
	Multimedia	
	Internet	
	Office	
	Reading	

Image Ratio	Full / Aspect / 1:1 / 17" (4:3) / 19" (4:3) / 19" (5:4) / 19"W (16:10) / 21.5"W (16:9) / 22"W (16:10) / 23"W (16:9) / 23.6"W (16:9) / 24"W (16:9)	Select image ratio for display.
-------------	--	---------------------------------

Note:

- 1). When "HDR Mode" is set to the non-off state, "Contrast", "Dark Boost", "Gamma", "Eco Adjustment", "Color Temp.", "6-Axis Color Saturation/Hue", "Color Gamut" and "LowBlue Mode" items can not be adjusted.
- 2). When "HDR" is set to "DisplayHDR" state, under "Picture" items other than "HDR" and "Sharpness" cannot be adjusted; When "HDR" is set to "HDR Picture", "HDR Movie" or "HDR Game", "Gamma", "Eco Adjustment", "Color Temp.", "6-Axis Color Saturation/Hue", "DCR", "Color Gamut" and "LowBlue Mode" items can not be adjusted.
- 3). When "Color Gamut" is set to "sRGB" or "DCI-P3", "Contrast", "Dark Boost", "Gamma", "Eco Adjustment", "Color Temp.", "6-Axis Color Saturation/Hue", HDR Mode and "LowBlue Mode" items can not be adjusted.
- 4). When "Eco Adjustment" is set to "Reading" or "Uniformity", "Contrast", "Dark Boost", "Color Temp.", "6-Axis Color Saturation/Hue", "DCR", "Color Gamut" and "LowBlue Mode" items can not be adjusted.
- 5). When under "Game Setting", "Game Mode" is set to the non "Standard" mode, "Eco Adjustment", "6-Axis Color Saturation/Hue", HDR Mode and "Color Gamut" items can not be adjusted.

PIP/PBP

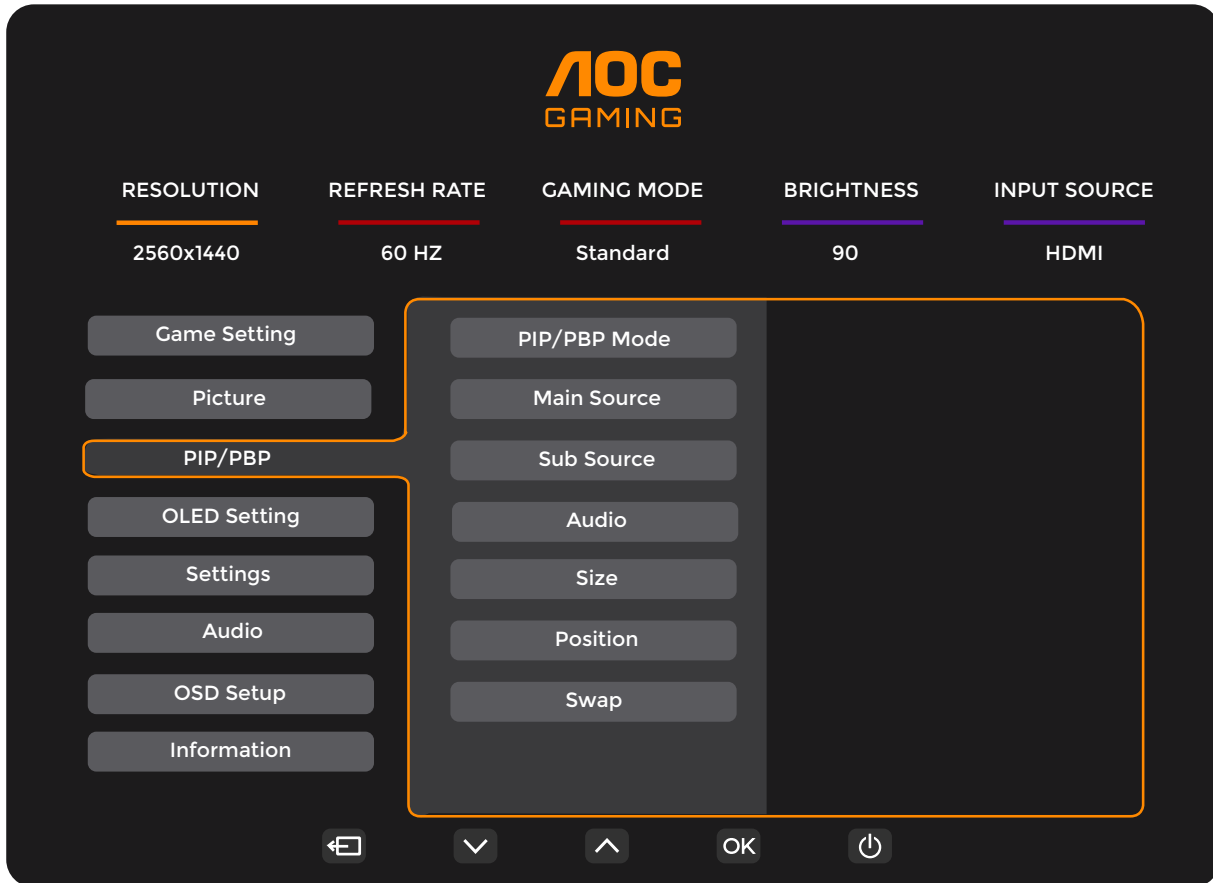

PIP/PBP Mode	Off / PIP / PBP	Disable or Enable PIP or PBP.
Main Source		Select main screen source.
Sub Source		Select sub screen source.
Audio	Main Source	Select Audio Setup.
	Sub Source	
Size	Small / Middle / Large	Select screen size.
Position	Right-up	Set the screen location.
	Right-down	
	Left-up	
	Left-down	
Swap	On: Swap	Swap the screen source.
	Off: non action	

Note:

1). When “HDR” under “Picture” is set to the non-off state, all items under “PIP/PBP” cannot be adjusted.

2) When PBP/PIP is enabled, the compatibility of the main screen/sub-screen input source is shown in the following table:

PBP/PIP		Main source	
		HDMI	DisplayPort
Sub source	HDMI	V	V
	DisplayPort	V	V

OLED Setting

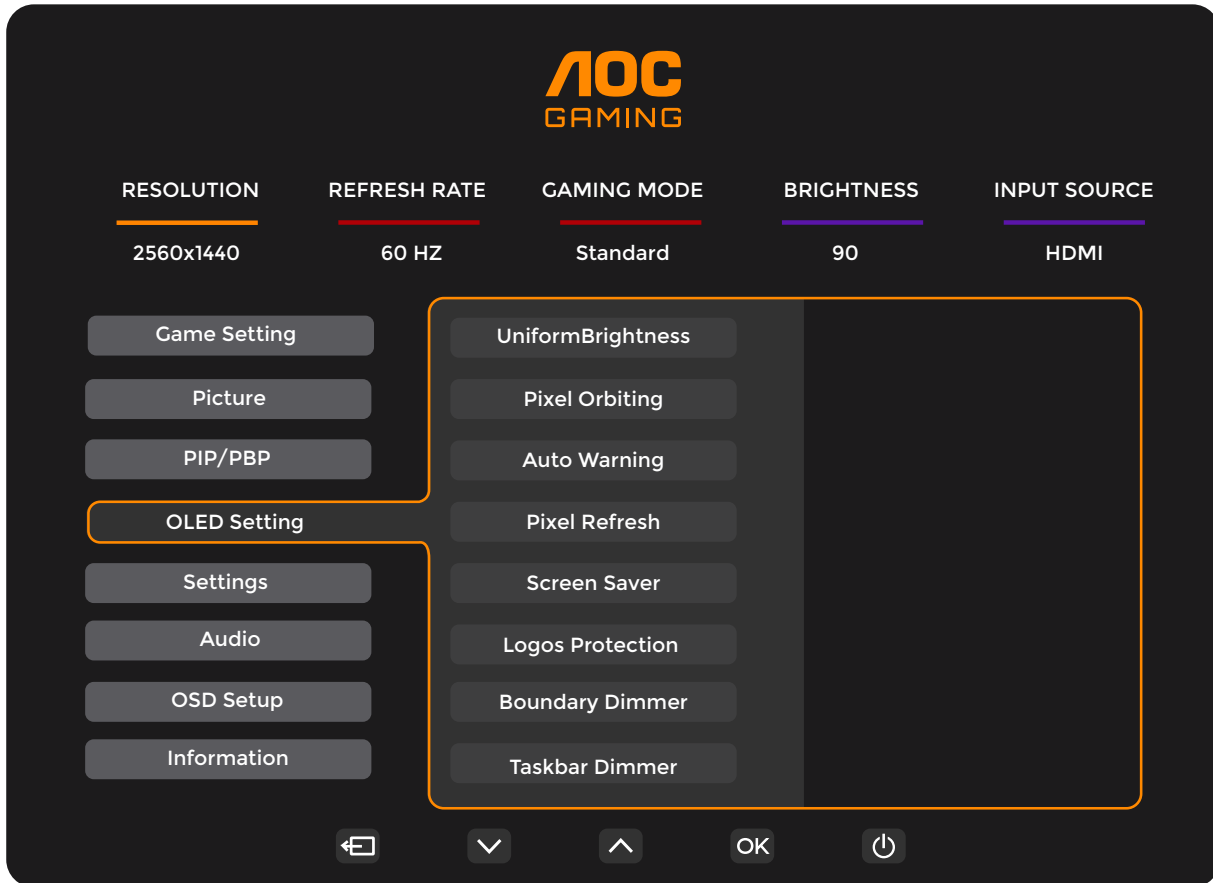

UniformBrightness	On/Off	Turn on Uniform Brightness, which equalizes the peak brightness in SDR mode, even when the white-screen window size changes.
Pixel Orbiting	Off / Weak / Medium /Strong	Orbit will slightly shift the displayed image at the pixel level, once a second to prevent image retention. This function is "On (Weak)" by default, "Weak" moves the least, "Strong" moves the most, "Off" disables the movement and increases the chance of image retention. This can be set in the OSD menu.
Auto Warning	On/ Off	Enable/Disable the "Pixel Refresh" Auto Warning feature. The monitor will automatically display an "Auto Warning" every 24 hours of cumulative usage to remind the user to run the "Pixel Refresh" process. Select "Off" to stop the Auto Warning for "Pixel Refresh." However, if the recommended time for running the " Pixel Refresh " is not followed, it may increase the risk of image retention on the screen. Please proceed with caution.
Pixel Refresh	On/ Off	This function will help eliminate image retention. After startup, select "Yes" from the menu prompt. The display will shutdown the screen and run the maintenance cycle. The power indicator will flash white (1 second on/1 second off) while the cycle runs, about 10 minutes. At the end of the cycle the power indicator will turn off and the display will be in standby state.

Screen Saver	Off / Slow / Fast	When a static image is detected for a certain period of time, the screen saver function will dim the screen to protect the panel from sticking. When a moving image is detected, the monitor will recover luminance to previous working status. Default setting is Slow and may change as Fast to active Screen Saver sooner. Would highly recommend that you always turn on Screen Saver as Slow or Fast to protect the screen. It is also recommended that you also set your device to use a screen saver.
Logos Protection	Off / 1 / 2 / 3 / 4	When there are multiple static logos detected on the screen, it's suggested to turn on logos Protection; which will dim the screen to protect the panel from image sticking where logos are detected.
Boundary Dimmer	Off / 1 / 2 / 3 / 4	For special aspect ratios that have a black area in the frame of the screen or a split-screen, the boundary dimmer feature can automatically detect and dim the brightness of specific areas with a large difference in brightness levels.
Taskbar Dimmer	Off / 1 / 2 / 3 / 4	The Taskbar Dimmer technology will dim the brightness of the taskbar area on the screen. No brightness changes will be noticeable in the areas other than in the taskbar.
ThermalProtection	Off / On	When the temperature of the monitor is over 60 degrees Celsius, the Thermal Protection feature will automatically dim the brightness of the screen in order to ensure heat dissipation properly. It is recommended that you turn on the feature for the monitor.

Settings

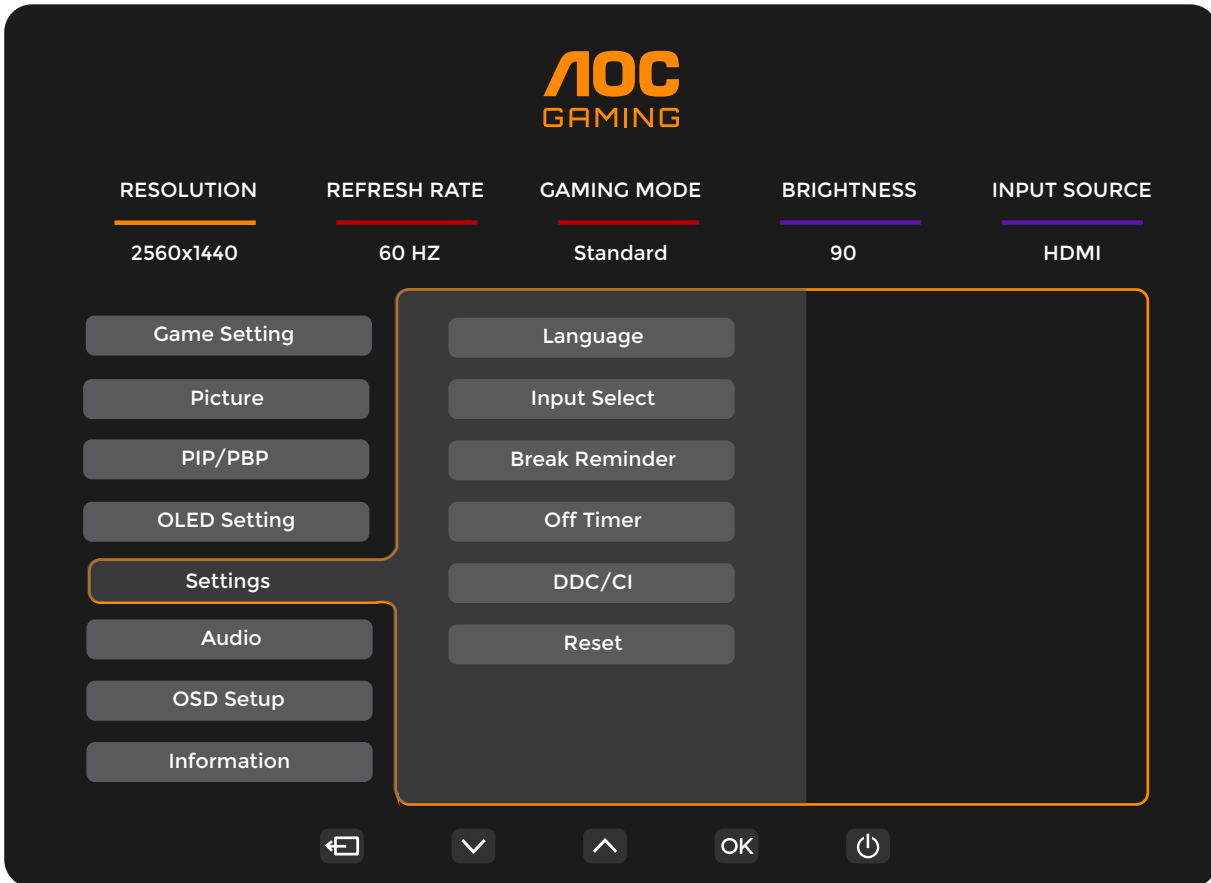

Language		Select the OSD language.
Input Select	Auto / HDMI / DP	Select Input Signal Source.
Break Reminder	Off / On	Break reminder if the user continuously works for more than 1hrs.
Off Timer	0-24 hrs	Select DC off time.
DDC/CI	No / Yes	Turn On/Off DDC/CI Support.
Reset	No / Yes	Reset the menu to default.

Audio

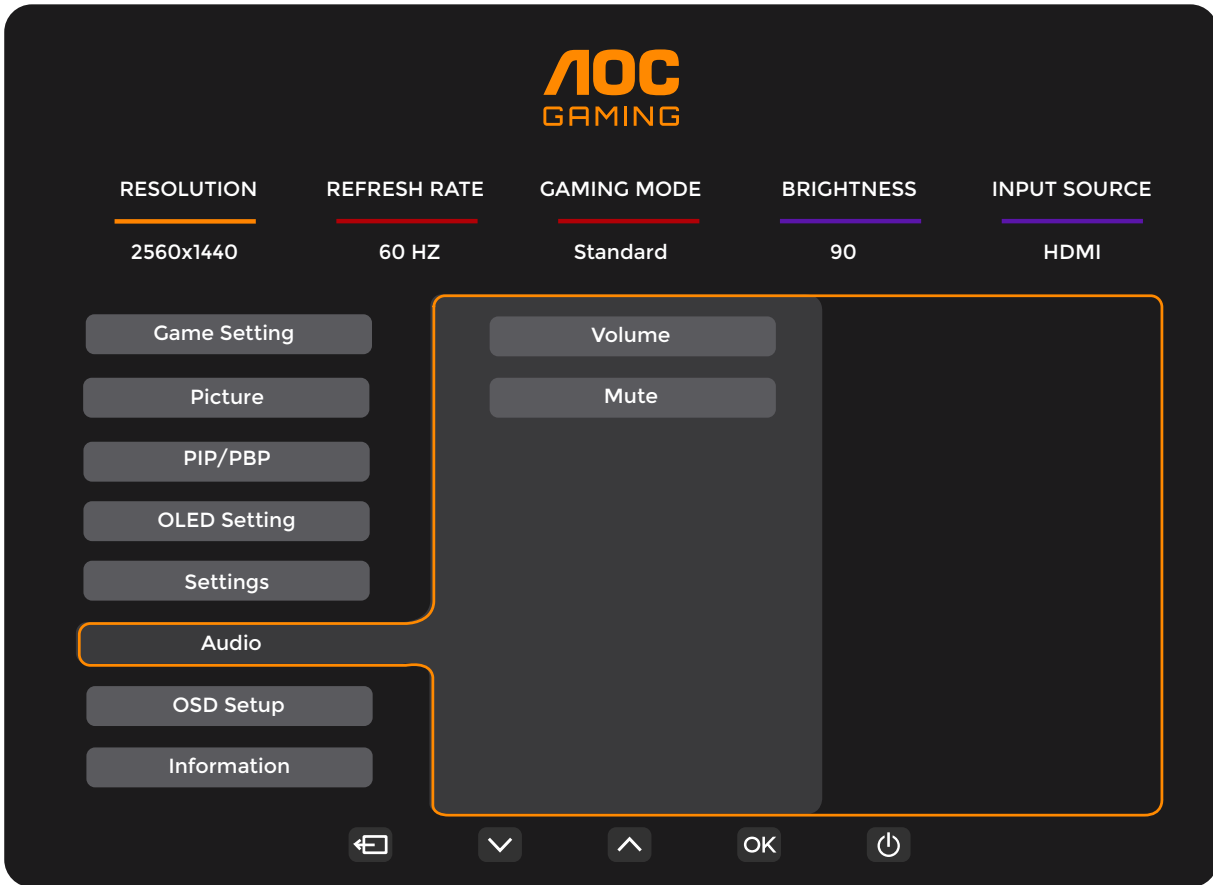

Volume	0-100	Volume Adjustment.
Mute	Off / On	Mute the volume.

OSD Setup

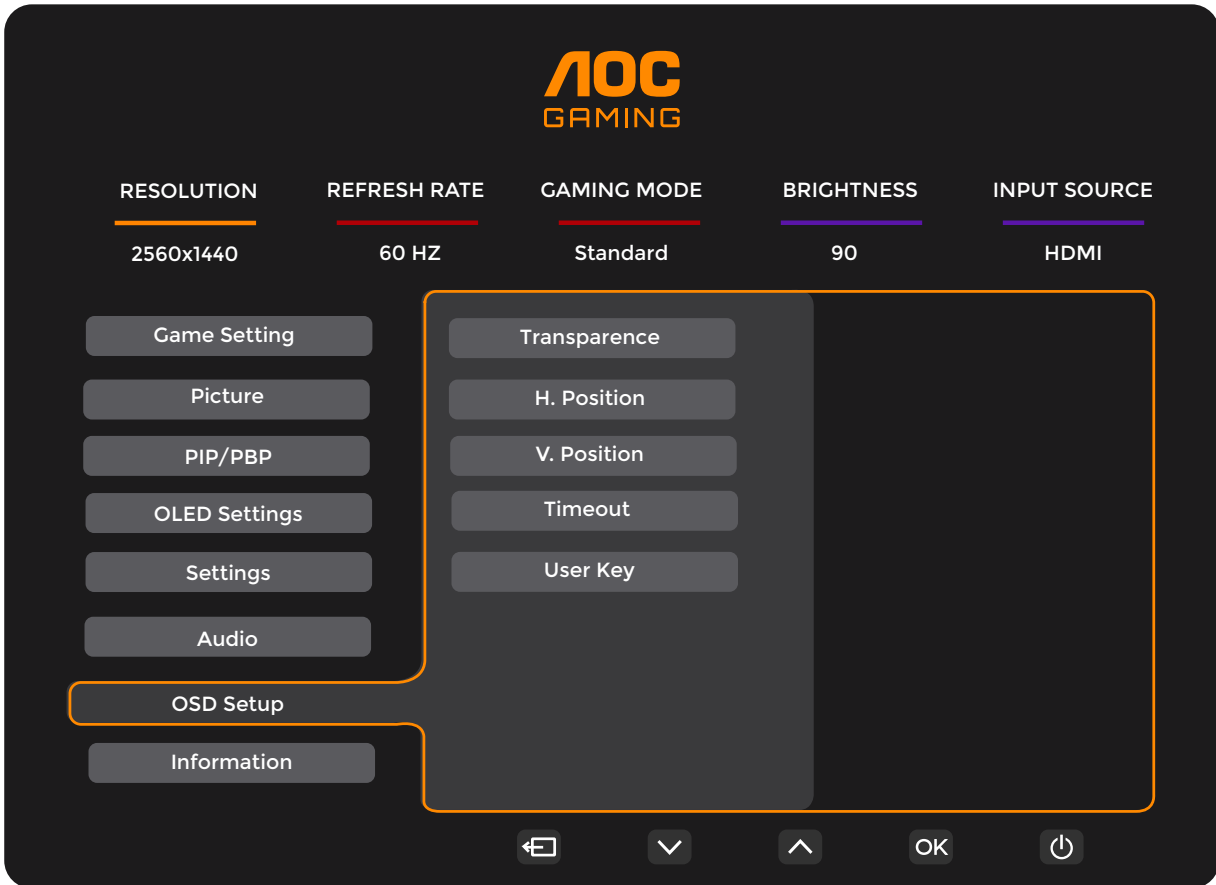

Transparence	0-100	Adjust the transparence of OSD.
H. Position	0-100	Adjust the horizontal position of OSD.
V. Position	0-100	Adjust the vertical position of OSD.
Timeout	5-120	Adjust the OSD Timeout.
User Key	Gaming Mode / Sniper Scope / Frame Counter	User set "V" key shortcut menu.

Information

The image shows the AOC Gaming OSD (On-Screen Display) in the 'Information' menu. At the top center is the AOC GAMING logo. Below it are five main settings categories: RESOLUTION (2560x1440), REFRESH RATE (60 HZ), GAMING MODE (Standard), BRIGHTNESS (90), and INPUT SOURCE (HDMI). On the left side, there is a vertical menu with options: Game Setting, Picture, PIP/PBP, OLED Setting, Settings, Audio, OSD Setup, and Information. The 'Information' option is selected and highlighted with an orange border. The main content area displays the following information:

Model Name	Q27G41ZDF
Resolution	2560(H)x1440(V)/60HZ
HDR	SDR
Sync	Adaptive-Sync
Serial Number	xxxxxxxx
Time after Pixel Refresh	xxx
Pixel Refresh Counts	xxx

At the bottom of the screen, there are five navigation icons: a left arrow, a down arrow, an up arrow, the text 'OK', and a power button icon.

LED Indicator

Status	LED Color
Full Power Mode	White
Active-off Mode	Orange
Pixel Refresh under process	Flashing White (1 second on / 1 second off)
OLED panel malfunction	Flashing Orange (1 second on / 1 second off)
Shutdown mode	The indicator is not lit.

Troubleshoot

Problems	Possible solutions
The power indicator is not lit.	<ul style="list-style-type: none"> ● Check if the power is turned on. ● Check if the power cord is connected. ● Check if the computer power is turned on.
The power indicator is lit, but there is no image display.	<ul style="list-style-type: none"> ● Check if the graphics card of the computer is well plugged. ● Check that the signal wire of the display has been correctly connected to the computer. ● Check the plug of the signal wire of the display, and make sure all pins are not bent. ● Observe the indicator through the Caps Lock key on the keypad of the computer to confirm if the computer is working.
There is no image, but the power indicator flashes orange.	<ul style="list-style-type: none"> ● The OLED panel malfunctions and fails to work properly. Seek advice from AOC after-sales service persons.
Failure to realize plug-to-use.	<ul style="list-style-type: none"> ● Check if it supports plug-to-use. ● Check if the adapter supports plug-to-use.
Dim image.	<ul style="list-style-type: none"> ● Adjust luminance and contrast ratio.
The image is bouncing or rippled.	<ul style="list-style-type: none"> ● There may be electrical appliances and devices at the periphery that may cause electronic interference.
The screen displays “the signal wire is not available” or “no signal.”	<ul style="list-style-type: none"> ● Check if the signal wire is correctly connected. ● Check if the pin of the signal wire plug is damaged. ● The Pixel Refresh function can be enabled and run in the display menu to eliminate image retention which has been generated. Running this function for several times can obtain a desirable image display effect. For other instructions regarding screen maintenance, refer to the User Instructions in the official website.
The screen displays “invalid input”.	<ul style="list-style-type: none"> ● Check if your computer is set in an improper display mode Please re-set your computer in the display mode listed in the detailed user instructions.
Image retention.	<ul style="list-style-type: none"> ● Based on the characteristics of the OLED panel, the Pixel Refresh function can be enabled and run in the display menu to eliminate image retention which has been generated. It is recommended to run this function for several times to obtain a desirable image display effect. For other instructions regarding screen maintenance, please refer to the User Instructions in the official website.
Regulation & Service	Please refer to Regulation & Service Information which is in the CD manual or www.aoc.com (to find the model you purchase in your country and to find Regulation & Service Information in Support page.

Specification

General Specification

Panel	Model name	Q27G41ZDF		
	Driving system	OLED		
	Viewable Image Size	67.3 cm diagonal		
	Pixel pitch	0.2292mm(H) x 0.2292mm(V)		
	Display Color	1.07B Colors ^[1]		
Others	Horizontal scan range	30k~230kHz(HDMI)		
		30k~390kHz(DisplayPort)		
	Horizontal scan Size(Maximum)	590.42 mm		
	Vertical scan range	48~144Hz(HDMI)		
		48~240Hz(DisplayPort)		
	Vertical Scan Size(Maximum)	333.72 mm		
	Optimal preset resolution	2560 x 1440@60Hz		
	Max resolution	2560 x 1440@144Hz(HDMI)		
		2560 x 1440@240Hz(DisplayPort)		
	Plug & Play	VESA DDC2B/CI		
	Power Source	100-240V~ 50/60Hz 1.5A		
	Power Consumption	Typical(default brightness and contrast)	63W	
		Max. (brightness = 100, contrast =100)	≤75W	
Standby Mode		≤0.3W		
Heat Dissipation	Normal Operation	215.02 BTU/hr (typ.)		
	Sleep (Standby mode)	<1.02 BTU/hr		
	Off mode(AC switch)	0 BTU/hr		
Physical Characteristics	Connector Type	HDMI/DisplayPort/Earphone		
	Signal Cable Type	Detachable		
Environmental	Temperature	Operating	0°C~40°C	
		Non-Operating	-25°C~55°C	
	Humidity	Operating	10%~85% (Non-Condensing)	
		Non-Operating	5%~93% (Non-Condensing)	
	Altitude	Operating	0m~5000m (0ft~16404ft)	
		Non-Operating	0m~12192m (0ft~40000ft)	



Note:

[1]The maximum number of display colors supported by this product is 1.07 billion, and the setting conditions are as follows (there may be differences due to the output limitation of some graphics cards)

("V":support, "\":nonsupport):

Signal Version Color Format State Color Bit	HDMI2.0		DisplayPort1.4	
	YCbCr420 YCbCr422	YCbCr444 RGB	YCbCr420 YCbCr422	YCbCr444 RGB
2560x1440 240Hz 10bits	\	\	V	V
2560x1440 240Hz 8bits	\	\	V	V
2560x1440 200Hz 10bits	\	\	V	V
2560x1440 200Hz 8bits	\	\	V	V
2560x1440 165Hz 10bits	\	\	V	V
2560x1440 165Hz 8bits	\	\	V	V
2560x1440 144Hz 10bits	V	\	V	V
2560x1440 144Hz 8bits	V	V	V	V
2560x1440 120Hz 10bits	V	\	V	V
2560x1440 120Hz 8bits	V	V	V	V
2560x1440 100Hz 10bits	V	\	V	V
2560x1440 100Hz 8bits	V	V	V	V
Low Resolution 10 bpc	V	V	V	V
Low Resolution 8 bpc	V	V	V	V

[2]: For DP1.4 (HBR3) signal input, in order to achieve QHD 240Hz 1.07 billion display color numbers (RGB/ YCbCr 4:4:4 format), you must use an OKDSC graphics card, please consult the graphics card manufacturer for DSC OK.

[3]: When the HDMI2.0 signal is input and the resolution is QHD 144Hz, it needs to be set to YCbCr 4:2:2/4:2:0 format to reach 1.07 billion display colors. Differences may occur due to output limitations of some graphics cards.

AOC Monitors Panel Pixel Defect Policy

AOC strives to deliver the highest quality products. We use some of the industry's most advanced manufacturing processes and practice stringent quality control. However, pixel or sub pixel defects on the Monitor panels used in the monitors are sometimes unavoidable.

No manufacturer can guarantee that all panels will be free from pixel defects, but AOC guarantees that any monitor with an unacceptable number of defects will be repaired or replaced under warranty. This notice explains the different types of pixel defects and defines acceptable defect levels for each type. In order to qualify for repair or replacement under warranty, the number of pixel defects on a Monitor panel must exceed these acceptable levels. For example, no more than 0.0004% of the sub pixels on a monitor may be defective.

Furthermore, AOC sets even higher quality standards for certain types or combinations of pixel defects that are more noticeable than others. This policy is valid worldwide.

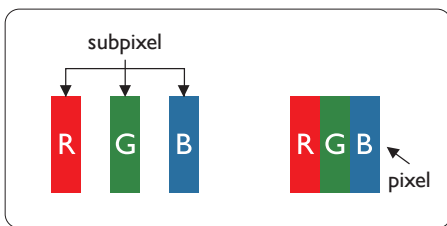

Pixels and Sub pixels

A pixel, or picture element, is composed of three sub pixels in the primary colors of red, green and blue. Many pixels together form an image. When all sub pixels of a pixel are lit, the three colored sub pixels together appear as a single white pixel. When all are dark, the three colored sub pixels together appear as a single black pixel. Other combinations of lit and dark sub pixels appear as single pixels of other colors.

Types of Pixel Defects

Pixel and sub pixel defects appear on the screen in different ways. There are two categories of pixel defects and several types of sub pixel defects within each category.

Bright Dot Defects

Bright dot defects appear as pixels or sub pixels that are always lit or 'on'. That is, a bright dot is a sub-pixel that stands out on the screen when the monitor displays a dark pattern. There are the types of bright dot defects.

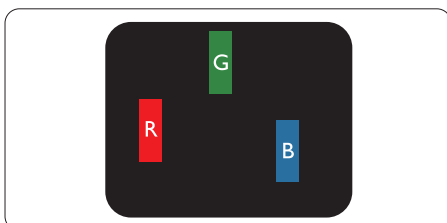

One lit red, green or blue sub pixel.

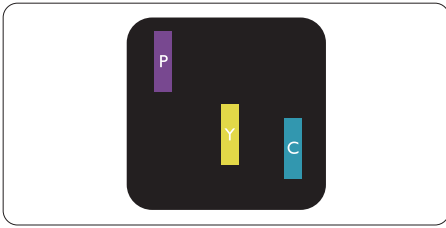

Two adjacent lit sub pixels:

- Red + Blue = Purple
- Red + Green = Yellow
- Green + Blue = Cyan (Light Blue)

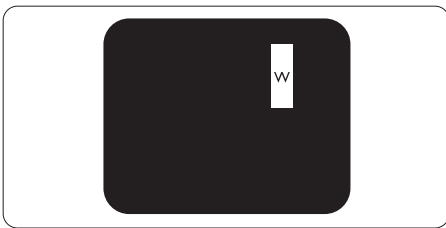

Three adjacent lit sub pixels (one white pixel).

Note:

A red or blue bright dot must be more than 50 percent brighter than neighboring dots while a green bright dot is 30 percent brighter than neighboring dots.

Black Dot Defects

Black dot defects appear as pixels or sub pixels that are always dark or 'off'. That is, a dark dot is a sub-pixel that stands out on the screen when the monitor displays a light pattern. These are the types of black dot defects.

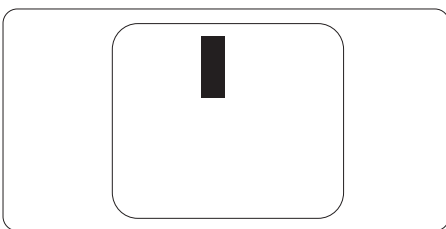

Proximity of Pixel Defects

Because pixel and sub pixels defects of the same type that are near to one another may be more noticeable, AOC also specifies tolerances for the proximity of pixel defects.

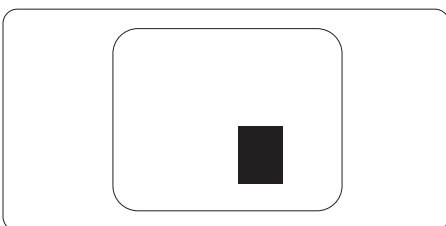

Pixel Defect Tolerances

In order to qualify for repair or replacement due to pixel defects during the warranty period, a Monitor panel in a AOC panel monitor must have pixel or sub pixel defects exceeding the tolerances listed in the web manual.

BRIGHT DOT DEFECTS	ACCEPTABLE LEVEL
1 lit subpixel	0
2 adjacent lit subpixels	0
3 adjacent lit subpixels (one white pixel)	0
Distance between two bright dot defects*	N/A
Total bright dot defects of all types	0
BLACK DOT DEFECTS	ACCEPTABLE LEVEL
1 dark subpixel	5 or fewer
2 adjacent dark subpixels	2 or fewer
3 adjacent dark subpixels	1 or fewer
Distance between two black dot defects*	≥5mm
Total black dot defects of all types	5 or fewer
TOTAL DOT DEFECTS	ACCEPTABLE LEVEL
Total bright or black dot defects of all types	5 or fewer

Note

*: 1 or 2 adjacent sub pixel defects = 1 dot defect.

Preset Display Modes

STANDARD	RESOLUTION(± 1 Hz)	HORIZONTAL FREQUENCY(KHz)	VERTICAL FREQUENCY(Hz)
VGA	640×480@60Hz	31.469	59.94
	640×480@72Hz	37.861	72.809
	640×480@75Hz	37.500	75
	640×480@100Hz	51.08	99.769
	640×480@120Hz	61.91	119.518
SVGA	800×600@56Hz	35.156	56.25
	800×600@60Hz	37.879	60.317
	800×600@72Hz	48.077	72.188
	800×600@75Hz	46.875	75
	800×600@100Hz	63.68	99.662
	800×600@120Hz	77.425	119.854
XGA	1024×768@60Hz	48.363	60.004
	1024×768@70Hz	56.476	70.069
	1024×768@75Hz	60.023	75.029
	1024×768@100Hz	81.577	99.972
	1024×768@120Hz	97.551	119.989
SXGA	1280×1024@60Hz	63.981	60.02
	1280×1024@75Hz	79.976	75.025
FHD	1920×1080@60Hz	67.5	60
	1920×1080@240Hz (DisplayPort)	274.562	240.001
QHD	2560×1440@60Hz	96.482	60.001
	2560×1440@100Hz	151	100
	2560×1440@120Hz	183	120
	2560×1440@144Hz	231.555	144.002
	2560×1440@165Hz (DisplayPort)	242.551	165
	2560×1440@200Hz (DisplayPort)	294	200
	2560×1440@240Hz (DisplayPort)	385.92	240
PBP	1280×1440@60Hz	89.45	59.913
	1280×1440@75Hz	111.972	74.998
	1280×1440@100Hz	149.3	100
	1280×1440@120Hz	179.157	119.998
MAC MODES			
VGA	640×480@67Hz	35	66.667
SVGA	832×624@75Hz	49.725	74.55
IBM MODES			
DOS	720×400@70Hz	31.469	70.087

Note: According to the VESA standard, there may be a certain error (± 1 Hz) when calculating the refresh rate (field frequency) of different operating systems and graphics cards. In order to improve compatibility, the nominal refresh rate of this product has been rounded off. Please refer to the actual product.

Pin Assignments



19-Pin Color Display Signal Cable

Pin No.	Signal Name	Pin No.	Signal Name	Pin No.	Signal Name
1.	TMDS Data 2+	9.	TMDS Data 0-	17.	DDC/CEC Ground
2.	TMDS Data 2 Shield	10.	TMDS Clock +	18.	+5V Power
3.	TMDS Data 2-	11.	TMDS Clock Shield	19.	Hot Plug Detect
4.	TMDS Data 1+	12.	TMDS Clock-		
5.	TMDS Data 1Shield	13.	CEC		
6.	TMDS Data 1-	14.	Reserved (N.C. on device)		
7.	TMDS Data 0+	15.	SCL		
8.	TMDS Data 0 Shield	16.	SDA		

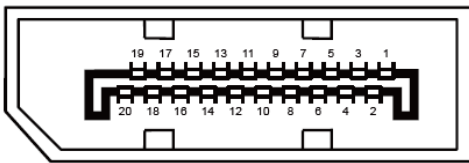

20-Pin Color Display Signal Cable

Pin No.	Signal Name	Pin No.	Signal Name
1	ML_Lane 3 (n)	11	GND
2	GND	12	ML_Lane 0 (p)
3	ML_Lane 3 (p)	13	CONFIG1
4	ML_Lane 2 (n)	14	CONFIG2
5	GND	15	AUX_CH(p)
6	ML_Lane 2 (p)	16	GND
7	ML_Lane 1 (n)	17	AUX_CH(n)
8	GND	18	Hot Plug Detect
9	ML_Lane 1 (p)	19	Return DP_PWR
10	ML_Lane 0 (n)	20	DP_PWR

Plug and Play

Plug & Play DDC2B Feature

This monitor is equipped with VESA DDC2B capabilities according to the VESA DDC STANDARD. It allows the monitor to inform the host system of its identity and, depending on the level of DDC used, communicate additional information about its display capabilities.

The DDC2B is a bi-directional data channel based on the I2C protocol. The host can request EDID information over the DDC2B channel.

