



CE&UKCA EMC Test Report

Project No. : 2409C041
Equipment : LCD Monitor
Brand Name : N/A
Model Name : CU34G4
Series Model : **34G4*****(*=0-9,A-Z,a-z,+,-,/,\ or blank)
Applicant : TPV Electronics (Fujian) Co., Ltd.
Address : Rongqiao Economic and Technological Development Zone, Fuqing City,
 Fujian Province, P.R. China
Date of Receipt : Sep. 06, 2024
Date of Test : Sep. 08, 2024 ~ Sep. 27, 2024
Issued Date : Oct. 23, 2024
Report Version : R00
Test Sample : Engineering Sample No.: DG2024090629
Standard(s) : Please refer to Page 2.

The above equipment has been tested and found compliance with the requirement of the relative standards by BTL Inc.

Albe Zhou

Prepared by : _____
 Albe Zhou

Kang Zhang

Approved by : _____
 Kang Zhang

Room 108, Building 2, No.1, Yile Road, Songshan Lake Zone, Dongguan City, Guangdong,
 People's Republic of China

Tel: +86-769-8318-3000 Web: www.newbtl.com Service mail: btl_qa@newbtl.com

Standard(s) : EN 55032:2015
EN 55032:2015+A11:2020
EN 55032:2015+A1:2020
CISPR 32:2015+AMD1:2019
AS/NZS CISPR 32:2015+AMD1:2020
EN 61000-3-2:2014
EN IEC 61000-3-2:2019+A1:2021
EN 61000-3-3:2013
EN 61000-3-3:2013+A1:2019
EN 61000-3-3:2013+A2:2021
EN 55035:2017/CISPR 35:2016
EN 55035:2017+A11:2020

BS EN 55032:2015
BS EN 55032:2015+A11:2020
BS EN 55032:2015+A1:2020
BS EN 61000-3-2:2014
BS EN IEC 61000-3-2:2019+A1:2021
BS EN 61000-3-3:2013
BS EN 61000-3-3:2013+A1:2019
BS EN 61000-3-3:2013+A2:2021
BS EN 55035:2017
BS EN 55035:2017+A11:2020

Declaration

BTL represents to the client that testing is done in accordance with standard procedures as applicable and that test instruments used has been calibrated with standards traceable to international standard(s) and/or national standard(s).

BTL's reports apply only to the specific samples tested under conditions. It is manufacture's responsibility to ensure that additional production units of this model are manufactured with the identical electrical and mechanical components. **BTL** assumes no responsibility for the data provided by the customer, any statements, inferences or generalizations drawn by the customer or others from the reports issued by **BTL**.

The report must not be used by the client to claim product certification, approval, or endorsement by A2LA or any agency of the U.S. Government.

This report is the confidential property of the client. As a mutual protection to the clients, the public and ourselves, the test report shall not be reproduced, except in full, without our written approval.

BTL's laboratory quality assurance procedures are in compliance with the ISO/IEC 17025: 2017 requirements, and accredited by the conformity assessment authorities listed in this test report.

BTL is not responsible for the sampling stage, so the results only apply to the sample as received.

The information, data and test plan are provided by manufacturer which may affect the validity of results, so it is manufacturer's responsibility to ensure that the apparatus meets the essential requirements of applied standards and in all the possible configurations as representative of its intended use.

Limitation

For the use of the authority's logo is limited unless the Test Standard(s)/Scope(s)/Item(s) mentioned in this test report is (are) included in the conformity assessment authorities acceptance respective.

Please note that the measurement uncertainty is provided for informational purpose only and are not use in determining the Pass/Fail results.

Table of Contents	Page
REPORT ISSUED HISTORY	8
1 . SUMMARY OF TEST RESULTS	9
1.1 TEST FACILITY	11
1.2 MEASUREMENT UNCERTAINTY	11
1.3 TEST ENVIRONMENT CONDITIONS	13
2 . GENERAL INFORMATION	14
2.1 GENERAL DESCRIPTION OF EUT	14
2.2 DESCRIPTION OF TEST MODES	15
2.3 EUT OPERATING CONDITIONS	18
2.4 BLOCK DIAGRAM SHOWING THE CONFIGURATION OF SYSTEM TESTED	18
2.5 DESCRIPTION OF SUPPORT UNITS	19
3 . EMC EMISSION TEST- EN 55032:2015	20
3.1 RADIATED EMISSIONS UP TO 1 GHZ	20
3.1.1 LIMITS	20
3.1.2 MEASUREMENT INSTRUMENTS LIST	20
3.1.3 TEST PROCEDURE	21
3.1.4 DEVIATION FROM TEST STANDARD	21
3.1.5 TEST SETUP	21
3.1.6 MEASUREMENT DISTANCE	22
3.1.7 TEST RESULTS	23
3.2 RADIATED EMISSIONS ABOVE 1 GHZ	25
3.2.1 LIMITS	25
3.2.2 MEASUREMENT INSTRUMENTS LIST	25
3.2.3 TEST PROCEDURE	26
3.2.4 DEVIATION FROM TEST STANDARD	26
3.2.5 TEST SETUP	26
3.2.6 MEASUREMENT DISTANCE	27
3.2.7 TEST RESULTS	28
3.3 CONDUCTED EMISSION MEASUREMENT AT AC MAINS POWER PORTS	30
3.3.1 LIMITS	30
3.3.2 MEASUREMENT INSTRUMENTS LIST	30
3.3.3 TEST PROCEDURE	30
3.3.4 DEVIATION FROM TEST STANDARD	31
3.3.5 TEST SETUP	31
3.3.6 TEST RESULTS	32
4 . EMC EMISSION TEST- EN 55032:2015+A11:2020	34
4.1 RADIATED EMISSIONS UP TO 1 GHZ	34
4.1.1 LIMITS	34
4.1.2 MEASUREMENT INSTRUMENTS LIST	34

Table of Contents	Page
4.1.3 TEST PROCEDURE	35
4.1.4 DEVIATION FROM TEST STANDARD	35
4.1.5 TEST SETUP	35
4.1.6 MEASUREMENT DISTANCE	36
4.1.7 TEST RESULTS	37
4.2 RADIATED EMISSIONS ABOVE 1 GHZ	47
4.2.1 LIMITS	47
4.2.2 MEASUREMENT INSTRUMENTS LIST	47
4.2.3 TEST PROCEDURE	48
4.2.4 DEVIATION FROM TEST STANDARD	48
4.2.5 TEST SETUP	48
4.2.6 MEASUREMENT DISTANCE	49
4.2.7 TEST RESULTS	50
4.3 CONDUCTED EMISSION MEASUREMENT AT AC MAINS POWER PORTS	60
4.3.1 LIMITS	60
4.3.2 MEASUREMENT INSTRUMENTS LIST	60
4.3.3 TEST PROCEDURE	60
4.3.4 DEVIATION FROM TEST STANDARD	60
4.3.5 TEST SETUP	61
4.3.6 TEST RESULTS	62
4.4 HARMONIC CURRENT EMISSIONS TEST	70
4.4.1 LIMITS	70
4.4.2 MEASUREMENT INSTRUMENTS LIST	70
4.4.3 TEST PROCEDURE	70
4.4.4 DEVIATION FROM TEST STANDARD	70
4.4.5 TEST SETUP	70
4.4.6 TEST RESULTS	71
4.5 VOLTAGE FLUCTUATIONS (FLICKER) TEST	74
4.5.1 LIMITS	74
4.5.2 MEASUREMENT INSTRUMENTS LIST	74
4.5.3 TEST PROCEDURE	74
4.5.4 DEVIATION FROM TEST STANDARD	74
4.5.5 TEST SETUP	75
4.5.6 TEST RESULTS	76
5 . EMC IMMUNITY TEST	77
5.1 STANDARD COMPLIANCE/SEVERITY LEVEL/CRITERIA	77
5.2 GENERAL PERFORMANCE CRITERIA	80
5.3 ANNEX D (NORMATIVE) - DISPLAY AND DISPLAY OUTPUT FUNCTION	81
5.3.1 PERFORMANCE CRITERIA	81
5.4 ANNEX G (NORMATIVE) - AUDIO OUTPUT FUNCTION	82
5.4.1 PERFORMANCE CRITERIA	82
5.5 ELECTROSTATIC DISCHARGE IMMUNITY TEST (ESD)	83

Table of Contents	Page
5.5.1 TEST SPECIFICATION	83
5.5.2 MEASUREMENT INSTRUMENTS	83
5.5.3 TEST PROCEDURE	83
5.5.4 DEVIATION FROM TEST STANDARD	84
5.5.5 TEST SETUP	84
5.5.6 TEST RESULTS	85
5.6 RADIATED, RADIO-FREQUENCY, ELECTROMAGNETIC FIELD IMMUNITY TEST (RS)	89
5.6.1 TEST SPECIFICATION	89
5.6.2 MEASUREMENT INSTRUMENTS	89
5.6.3 TEST PROCEDURE	89
5.6.4 DEVIATION FROM TEST STANDARD	90
5.6.5 TEST SETUP	90
5.6.6 TEST RESULTS	92
5.7 ELECTRICAL FAST TRANSIENT/BURST IMMUNITY TEST (EFT)	95
5.7.1 TEST SPECIFICATION	95
5.7.2 MEASUREMENT INSTRUMENTS	95
5.7.3 TEST PROCEDURE	95
5.7.4 DEVIATION FROM TEST STANDARD	95
5.7.5 TEST SETUP	96
5.7.6 TEST RESULTS	97
5.8 SURGE IMMUNITY TEST (SURGE)	98
5.8.1 TEST SPECIFICATION	98
5.8.2 MEASUREMENT INSTRUMENTS	98
5.8.3 TEST PROCEDURE	98
5.8.4 DEVIATION FROM TEST STANDARD	98
5.8.5 TEST SETUP	99
5.8.6 TEST RESULTS	100
5.9 IMMUNITY TO CONDUCTED DISTURBANCES, INDUCED BY RADIO-FREQUENCY FIELDS TEST (CS)	101
5.9.1 TEST SPECIFICATION	101
5.9.2 MEASUREMENT INSTRUMENTS	101
5.9.3 TEST PROCEDURE	101
5.9.4 DEVIATION FROM TEST STANDARD	102
5.9.5 TEST SETUP	102
5.9.6 TEST RESULTS	103
5.10 POWER FREQUENCY MAGNETIC FIELD IMMUNITY TEST (PFMF)	105
5.10.1 TEST SPECIFICATION	105
5.10.2 MEASUREMENT INSTRUMENTS	105
5.10.3 TEST PROCEDURE	105
5.10.4 DEVIATION FROM TEST STANDARD	105
5.10.5 TEST SETUP	106
5.10.6 TEST RESULTS	107
5.11 VOLTAGE DIPS, SHORT INTERRUPTIONS AND VOLTAGE VARIATIONS IMMUNITY	

Table of Contents**Page**

TEST (DIPS)	108
5.11.1 TEST SPECIFICATION	108
5.11.2 MEASUREMENT INSTRUMENTS	108
5.11.3 TEST PROCEDURE	108
5.11.4 DEVIATION FROM TEST STANDARD	108
5.11.5 TEST SETUP	108
5.11.6 TEST RESULTS	109
6 . EUT TEST PHOTO	110

REPORT ISSUED HISTORY

Report No.	Version	Description	Issued Date	Note
BTL-EMC-1-2409C041	R00	Original report.	Oct. 23, 2024	Valid

1. SUMMARY OF TEST RESULTS

Test procedures according to the technical standards:

Emission			
Standard(s)	Test Item	Result	
EN 55032:2015 EN 55032:2015+A11:2020 EN 55032:2015+A1:2020 CISPR 32:2015+AMD1:2019 AS/NZS CISPR 32:2015+AMD1:2020 BS EN 55032:2015 BS EN 55032:2015+A11:2020 BS EN 55032:2015+A1:2020	Radiated emissions up to 1 GHz	PASS	
	Radiated emissions above 1 GHz	PASS	
	Radiated emissions from FM receivers	N/A	
	Conducted emissions AC mains power port	PASS	
	Asymmetric mode conducted emissions	AAN	N/A
		Current Probe	N/A
		CP+CVP	N/A
Conducted differential voltage emissions	N/A		

Standard(s)	Test Item	Result
EN 61000-3-2:2014 EN IEC 61000-3-2:2019+A1:2021 BS EN 61000-3-2:2014 BS EN IEC 61000-3-2:2019+A1:2021	Harmonic current	PASS
EN 61000-3-3:2013 EN 61000-3-3:2013+A1:2019 EN 61000-3-3:2013+A2:2021 BS EN 61000-3-3:2013 BS EN 61000-3-3:2013+A1:2019 BS EN 61000-3-3:2013+A2:2021	Voltage fluctuations (Flicker)	PASS

Immunity			
Standard(s)	Ref Standard(s)	Test Item	Result
EN 55035:2017/CISPR 35:2016 EN 55035:2017+A11:2020 BS EN 55035:2017 BS EN 55035:2017+A11:2020	IEC 61000-4-2:2008 EN 61000-4-2:2009	ESD	PASS
	IEC 61000-4-3:2020 EN IEC 61000-4-3:2020	RS	PASS
	IEC 61000-4-4:2012 EN 61000-4-4:2012	EFT	PASS
	IEC 61000-4-5:2014+AMD1:2017 EN 61000-4-5:2014+A1:2017	Surge	PASS
	IEC 61000-4-6:2013 EN 61000-4-6:2014+AC:2015	CS	PASS
	IEC 61000-4-8:2009 EN 61000-4-8:2010	PFMF	PASS
	IEC 61000-4-11:2020 EN IEC 61000-4-11:2020	Dips	PASS

Standard(s)	Section	Test Item	Result
EN 55035:2017/CISPR 35:2016 EN 55035:2017+A11:2020	4.2.7	BIN-R	N/A
BS EN 55035:2017 BS EN 55035:2017+A11:2020	4.2.7	BIN-I	N/A

NOTE:

- (1) "N/A" denotes test is not applicable to this device.

1.1 TEST FACILITY

The test facilities used to collect the test data in this report is

1# For CS test item: Room 108, Building 2, No.1, Yile Road, Songshan Lake Zone, Dongguan City, Guangdong, People's Republic of China.

2# For other test items: No.3, Jinshagang 1st Road, Dalang Town, Dongguan City, Guangdong People's Republic of China.

1.2 MEASUREMENT UNCERTAINTY

Where relevant, the following measurement uncertainty levels have been estimated for tests performed on the EUT as specified in CISPR 16-4-2, The BTL measurement uncertainty is less than the CISPR 16-4-2 U_{CISPR} requirement.

The reported uncertainty of measurement $y \pm U$, where expanded uncertainty U is based on a standard uncertainty multiplied by a coverage factor of $k=2$, providing a level of confidence of approximately **95%**.

A. Radiated emissions up to 1 GHz measurement:

Test Site	Method	Measurement Frequency Range	Ant. H / V	U ,(dB)
DG-CB08 (10m)	CISPR	30MHz ~ 200MHz	V	4.48
		30MHz ~ 200MHz	H	4.50
		200MHz ~ 1,000MHz	V	4.60
		200MHz ~ 1,000MHz	H	4.84

B. Radiated emissions above 1 GHz measurement:

Test Site	Method	Measurement Frequency Range	U ,(dB)
DG-CB08 (3m)	CISPR	1GHz ~ 6GHz	4.24

C. Conducted emissions AC mains power port measurement:

Test Site	Method	Measurement Frequency Range	U ,(dB)
DG-C02	CISPR	150kHz ~ 30MHz	2.88

D. Harmonic current / Voltage fluctuations (Flicker) measurement:

Test Site	Method	Item	U (%)
DG-C01	EN 61000-3-2 EN 61000-3-3	Current	0.757
		Voltage	0.592

E. Immunity Measurement:

Test Site	Method	Item	<i>U</i>
DG-SR02	IEC 61000-4-2	Rise time t_r	7.00%
		Peak current I_p	6.50%
		Current at 30 ns	6.60%
		Current at 60 ns	6.80%
DG-CB05	IEC 61000-4-3 (80MHz~6GHz)	Electromagnetic field immunity test	2.2dB
		On-ear acoustic & Acoustic measurements on loudspeakers	2.24dB
DG-SR05	IEC 61000-4-4	Peak voltage (VP)	3.8%
		Rise time (t_r)	4.4%
		Pulse width(t_w)	4.2%
		Pulse Freq.(kHz)	0.7%
		Burst Duration(ms)	1.5%
		Burst Period(ms)	1.4%
DG-SR05	IEC 61000-4-5	Open-Circuit Output Voltage (1.2/50us)	4.0%
		Open circuit front time (1.2/50us)	6.2%
		Open circuit time of half value (1.2/50us)	4.7%
SSL-CB02	IEC 61000-4-6 (150kHz-80MHz)	CDN	1.28dB
		On-ear acoustic & Acoustic measurements on loudspeakers	1.28dB
DG-SR05	IEC 61000-4-8	Magnetic Field Strength	1.91%
DG-SR01	IEC 61000-4-11	DIP Amplitude	3.6%
		DIP Time Event	4.0%

Note: Unless specifically mentioned, the uncertainty of measurement has not been taken into account to declare the compliance or non-compliance to the specification.

1.3 TEST ENVIRONMENT CONDITIONS

Test Item	Temperature	Humidity	Tested By	Test Date
Radiated emissions up to 1 GHz	21°C	46%	Zinco Chen	Sep. 24, 2024
Radiated emissions above 1 GHz	21°C	46%	Zinco Chen	Sep. 24, 2024
Conducted emissions AC mains power port	25°C	48%	Yang Yan	Sep. 21, 2024
Harmonic current	24°C	46%	Bernie Wu	Sep. 18, 2024
Voltage fluctuations (Flicker)	24°C	46%	Bernie Wu	Sep. 18, 2024

Test Item	Temperature	Humidity	Pressure	Tested By	Test Date
ESD	28°C	48%	1010hPa	Jerry Lu	Sep. 11, 2024
RS	24°C	56%	/	Ternence Li	Sep. 19, 2024- Sep. 20, 2024
EFT	29°C	50%	/	Sean Wan	Sep. 19, 2024
Surge	29°C	50%	/	Sean Wan	Sep. 19, 2024
CS	23°C	53%	/	Edison Yi	Sep. 12, 2024
PFMF	29°C	50%	/	Sean Wan	Sep. 19, 2024
Dips	25°C	60%	/	Ellery Liang	Sep. 14, 2024

2. GENERAL INFORMATION

2.1 GENERAL DESCRIPTION OF EUT

Equipment	LCD Monitor
Brand Name	N/A
Model Name	CU34G4
Series Model	**34G4*****(*=0-9,A-Z,a-z,+,-,/, \ or blank)
Model Difference(s)	Only differ in model name due to marketing purpose.
Identification No. of EUT(S/N)	N/A
Dimensions and mass	808.1*269.6*534.7 mm
Component unit of EUT	<input checked="" type="checkbox"/> Single unit <input type="checkbox"/> Multiple unit
Sample Status	<input checked="" type="checkbox"/> Engineering sample <input type="checkbox"/> Final shipment prototype
Power Source	AC Mains.
Power Rating	100-240V ~ 50/60Hz 1.5A
Connecting I/O Port(s)	1* AC port 2* HDMI port 1* DP port 1* Earphone port 1* USB-B port 2* USB port
Classification of EUT	Class B
Highest Internal Frequency(Fx)	597MHz

Cable Type	Shielded Type	Ferrite Core	Length(m)	Note
AC Power Cord	Non-shielded	NO	1.8/1.5/1.2	-
HDMI	Shielded	NO	1.8/1.5/1.2	-
DP	Shielded	NO	1.8/1.5/1.2	-
USB3.0	Shielded	NO	1.8/1.5/1.2	-

Note:

1. For a more detailed features description, please refer to the manufacturer's specifications or the user's manual.

2.2 DESCRIPTION OF TEST MODES

To investigate the maximum EMI emission characteristics generated from EUT, the test system was pre-scanning tested based on the consideration of following EUT operation mode or test configuration mode which possible have effect on EMI emission level. Each of these EUT operation mode(s) or test configuration mode(s) mentioned above was evaluated respectively.

Pretest Mode	Description
Mode 1	HDMI 1 3440x1440 /240Hz 1.8m PC (USB-B connects to a PC+USB-A1 R/W+USB-A2 Output 5V/1.5A) (Panel: Horizontal)
Mode 2	HDMI 1 3440x1440 /240Hz 1.8m PC (USB-B connects to a PC+USB-A1/2 R/W) (Panel: Horizontal)
Mode 3	HDMI 2 3440x1440 /240Hz 1.8m PC (USB-B connects to a PC+USB-A1 R/W+USB-A2 Output 5V/1.5A) (Panel: Horizontal)
Mode 4	DP 3440x1440 /240Hz 1.8m PC (USB-B connects to a PC+USB-A1 R/W+USB-A2 Output 5V/1.5A) (Panel: Horizontal)
Mode 5	HDMI 1 1080P 1.8m DVD (Panel: Horizontal)
Mode 6	HDMI 1 1920x1080 /60Hz 1.8m PC (USB-B connects to a PC+USB-A1 R/W+USB-A2 Output 5V/1.5A) (Panel: Horizontal)
Mode 7	HDMI 1 640*480/60Hz 1.8m PC (USB-B connects to a PC+USB-A1 R/W+USB-A2 Output 5V/1.5A) (Panel: Horizontal)
Mode 8	HDMI 1 3440x1440 /240Hz 1.5m PC (USB-B connects to a PC+USB-A1 R/W+USB-A2 Output 5V/1.5A) (Panel: Horizontal)
Mode 9	HDMI 2 3440x1440 /240Hz 1.5m PC (USB-B connects to a PC+USB-A1 R/W+USB-A2 Output 5V/1.5A) (Panel: Horizontal)
Mode 10	DP 3440x1440 /240Hz 1.5m PC (USB-B connects to a PC+USB-A1 R/W+USB-A2 Output 5V/1.5A) (Panel: Horizontal)
Mode 11	HDMI 1 3440x1440 /240Hz 1.2m PC (USB-B connects to a PC+USB-A1 R/W+USB-A2 Output 5V/1.5A) (Panel: Horizontal)
Mode 12	HDMI 2 3440x1440 /240Hz 1.2m PC (USB-B connects to a PC+USB-A1 R/W+USB-A2 Output 5V/1.5A) (Panel: Horizontal)
Mode 13	DP 3440x1440 /240Hz 1.2m PC (USB-B connects to a PC+USB-A1 R/W+USB-A2 Output 5V/1.5A) (Panel: Horizontal)
Mode 14	HDMI 1 3440x1440 /240Hz 1.8m PC (USB-B connects to a PC+USB-A1 R/W+USB-A2 Output 5V/1.5A) (Panel: Vertical)
Mode 15	HDMI 1 3440x1440 /240Hz 1.8m PC (USB-B connects to a PC+USB-A1 R/W+USB-A2 Output 5V/1.5A) (Panel: Horizontal) (Without Earphone)

Radiated emissions up to 1 GHz Test	
Final Test Mode	Description
Mode 1	HDMI 1 3440x1440 /240Hz 1.8m PC (USB-B connects to a PC+USB-A1 R/W+USB-A2 Output 5V/1.5A) (Panel: Horizontal)
Mode 4	DP 3440x1440 /240Hz 1.8m PC (USB-B connects to a PC+USB-A1 R/W+USB-A2 Output 5V/1.5A) (Panel: Horizontal)
Mode 5	HDMI 1 1080P 1.8m DVD (Panel: Horizontal)
Mode 15	HDMI 1 3440x1440 /240Hz 1.8m PC (USB-B connects to a PC+USB-A1 R/W+USB-A2 Output 5V/1.5A) (Panel: Horizontal) (Without Earphone)

Radiated emissions Above 1 GHz Test	
Final Test Mode	Description
Mode 1	HDMI 1 3440x1440 /240Hz 1.8m PC (USB-B connects to a PC+USB-A1 R/W+USB-A2 Output 5V/1.5A) (Panel: Horizontal)
Mode 4	DP 3440x1440 /240Hz 1.8m PC (USB-B connects to a PC+USB-A1 R/W+USB-A2 Output 5V/1.5A) (Panel: Horizontal)
Mode 5	HDMI 1 1080P 1.8m DVD (Panel: Horizontal)
Mode 15	HDMI 1 3440x1440 /240Hz 1.8m PC (USB-B connects to a PC+USB-A1 R/W+USB-A2 Output 5V/1.5A) (Panel: Horizontal) (Without Earphone)

Conducted emissions AC mains power port Test	
Final Test Mode	Description
Mode 1	HDMI 1 3440x1440 /240Hz 1.8m PC (USB-B connects to a PC+USB-A1 R/W+USB-A2 Output 5V/1.5A) (Panel: Horizontal)
Mode 4	DP 3440x1440 /240Hz 1.8m PC (USB-B connects to a PC+USB-A1 R/W+USB-A2 Output 5V/1.5A) (Panel: Horizontal)
Mode 5	HDMI 1 1080P 1.8m DVD (Panel: Horizontal)

Harmonic current & Voltage fluctuations (Flicker) Test	
Final Test Mode	Description
Mode 1	HDMI 1 3440x1440 /240Hz 1.8m PC (USB-B connects to a PC+USB-A1 R/W+USB-A2 Output 5V/1.5A) (Panel: Horizontal)

Immunity Test	
Final Test Mode	Description
Mode 1	HDMI 1 3440x1440 /240Hz 1.8m PC (USB-B connects to a PC+USB-A1 R/W+USB-A2 Output 5V/1.5A) (Panel: Horizontal)
Mode 2	HDMI 1 3440x1440 /240Hz 1.8m PC (USB-B connects to a PC+USB-A1/2 R/W) (Panel: Horizontal)
Mode 3	HDMI 2 3440x1440 /240Hz 1.8m PC (USB-B connects to a PC+USB-A1 R/W+USB-A2 Output 5V/1.5A) (Panel: Horizontal)
Mode 4	DP 3440x1440 /240Hz 1.8m PC (USB-B connects to a PC+USB-A1 R/W+USB-A2 Output 5V/1.5A) (Panel: Horizontal)
Mode 5	HDMI 1 1080P 1.8m DVD (Panel: Horizontal)
Mode 8	HDMI 1 3440x1440 /240Hz 1.5m PC (USB-B connects to a PC+USB-A1 R/W+USB-A2 Output 5V/1.5A) (Panel: Horizontal)
Mode 9	HDMI 2 3440x1440 /240Hz 1.5m PC (USB-B connects to a PC+USB-A1 R/W+USB-A2 Output 5V/1.5A) (Panel: Horizontal)
Mode 10	DP 3440x1440 /240Hz 1.5m PC (USB-B connects to a PC+USB-A1 R/W+USB-A2 Output 5V/1.5A) (Panel: Horizontal)
Mode 11	HDMI 1 3440x1440 /240Hz 1.2m PC (USB-B connects to a PC+USB-A1 R/W+USB-A2 Output 5V/1.5A) (Panel: Horizontal)
Mode 12	HDMI 2 3440x1440 /240Hz 1.2m PC (USB-B connects to a PC+USB-A1 R/W+USB-A2 Output 5V/1.5A) (Panel: Horizontal)
Mode 13	DP 3440x1440 /240Hz 1.2m PC (USB-B connects to a PC+USB-A1 R/W+USB-A2 Output 5V/1.5A) (Panel: Horizontal)

Note:

1. For EMI: the standard of EN 55032:2015+A11:2020 tested all the modes, and the EN 55032:2015 tested the worst case and recorded in the test report.
2. For Radiated emissions: Evaluated the mode 1-15. According to the client's requirement, choose mode 1, mode 4, mode 5, and mode 15 and recorded in test report.
3. For Conducted emissions: Evaluated the mode 1-13. According to the client's requirement, choose mode 1, mode 4, and mode 5 and recorded in test report.
4. RS: The Front, Rear, Left and Right were evaluated. The worst placement direction is Front and recorded in this report.
5. The audio output function of CS/RS is recorded the worst mode.

2.3 EUT OPERATING CONDITIONS

The EUT exercise program used during radiated and/or conducted emission measurement was designed to exercise the various system components in a manner similar to a typical use. The standard test signals and output signal as following:

1. EUT connected to Earphone via Earphone Cable.
2. EUT connected to LOAD & USB3.0 Hard Disk via USB Cable.
3. EUT connected to PC via HDMI & DP & USB-B Cable.
4. PC connected to Mouse & Keyboard via USB Cable.

2.4 BLOCK DIAGRAM SHOWING THE CONFIGURATION OF SYSTEM TESTED

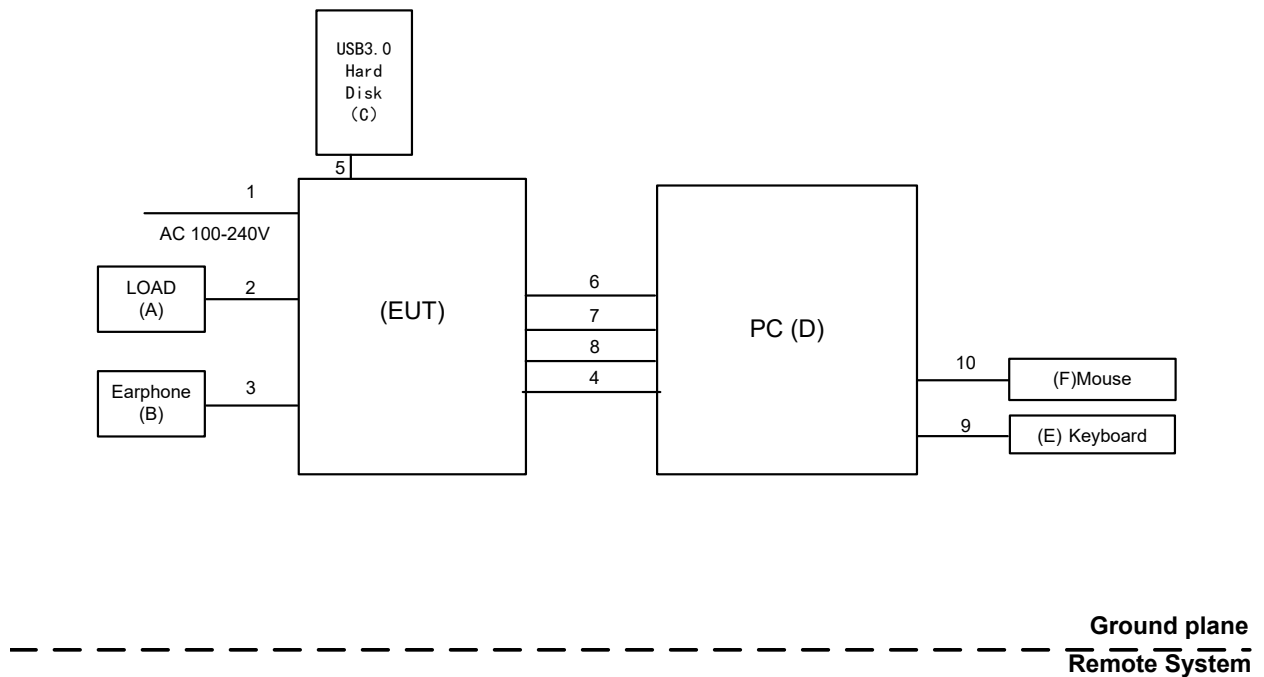

2.5 DESCRIPTION OF SUPPORT UNITS

The EUT has been tested as an independent unit together with other necessary accessories or support units. The following support units or accessories were used to form a representative test configuration during the tests.

For CS items:

Item	Equipment	Mfr/Brand	Model/Type No.	Series No.
A	LOAD	N/A	N/A	N/A
B	Earphone	APPLE	N/A	N/A
C	USB3.0 Hard Disk	LACIE	RUGU3M2	NL67EWNQ
D	PC	DELL	8920-D15N8	C7T9GL2
E	Keyboard	DELL	KB216D1	N/A
F	Mouse	DELL	MS116T1	N/A

For other items:

Item	Equipment	Mfr/Brand	Model/Type No.	Series No.
A	LOAD	N/A	N/A	N/A
B	Earphone	APPLE	N/A	N/A
C	USB3.0 Hard Disk	LACIE	Lacie S.A Series	NL34BFER
D	PC	DELL	8920-D16N8S	GZS91L2
E	Keyboard	DELL	KB212-B	CN0HTXH97158125004DXA01
F	Mouse	DELL	MS111-P	CN011D3V71581279OLOT

Item	Cable Type	Shielded Type	Ferrite Core	Length
1	AC Cable	NO	NO	1.8/1.5/1.2m
2	USB Cable	YES	NO	1.2m
3	Earphone Cable	NO	NO	1.2m
4	HDMI Cable	YES	NO	1.8/1.5/1.2m
5	USB Cable	YES	NO	1.2m
6	HDMI Cable	YES	NO	1.8/1.5/1.2m
7	DP Cable	YES	NO	1.8/1.5/1.2m
8	USB-B Cable	YES	NO	1.8/1.5/1.2m
9	USB Cable	YES	NO	1.8m
10	USB Cable	YES	NO	1.8m

3. EMC EMISSION TEST- EN 55032:2015

3.1 RADIATED EMISSIONS UP TO 1 GHZ

3.1.1 LIMITS

Class B equipment up to 1 GHz

Frequency Range MHz	Measurement			Class B limits dB(μV/m)
	Facility	Distance m	Detector type/ bandwidth	
30 - 230	SAC	10	Quasi peak / 120 kHz	30
230 - 1000				37

Notes:

- (1) The limit for radiated test was performed according to as following: EN 55032
- (2) The tighter limit applies at the band edges.
- (3) Emission level (dBuV/m)=20log Emission level (uV/m).
- (4) The test result calculated as following:
 Measurement Value = Reading Level + Correct Factor
 Correct Factor = Antenna Factor + Cable Loss - Amplifier Gain(if use)
 Margin Level = Measurement Value - Limit Value

3.1.2 MEASUREMENT INSTRUMENTS LIST

Item	Kind of Equipment	Manufacturer	Type No.	Serial No.	Calibrated until
1	Receiver	Keysight	N9038A	MY54450004	Jun. 01, 2025
2	MXE EMI Receiver	Agilent	N9038A	MY53220133	Jun. 01, 2025
3	Pre-Amplifier	EMC INSTRUMENT	EMC 9135	980284	May 31, 2025
4	Pre-Amplifier	EMC INSTRUMENT	EMC 9135	980283	May 31, 2025
5	Trilog-Broadband Antenna	Schwarzbeck	VULB9168	947	Nov. 10, 2024
6	Attenuator	EMCI	EMCI-N-6-06	AT-N0670	Nov. 10, 2024
7	Trilog-Broadband Antenna	Schwarzbeck	VULB9168	1461	Nov. 28, 2024
8	Attenuator	EMC INSTRUMENT	EMCI-N-6-06	AT-06010	Nov. 28, 2024
9	Measurement Software	Farad	EZ-EMC Ver.BTL-2ANT-1	N/A	N/A
10	Multi-Device Controller	ETS-Lindgren	2090	N/A	N/A
11	Controller	MF	MF-7802	MF780208159	N/A
12	Cable	RW	LMR400-NMNM-10M	N/A	Dec. 03, 2024
13	Cable	RW	LMR400-NMNM-7M	N/A	Dec. 03, 2024
14	Cable	RW	LMR400-NMNM-3.5M	N/A	Dec. 03, 2024
15	Cable	RW	LMR400-NMNM-7M	N/A	Sep. 04, 2025
16	Cable	RW	LMR400-NMNM-8M	N/A	Sep. 04, 2025
17	Cable	RW	LMR400-NMNM-3.5M	N/A	Sep. 04, 2025

Remark: "N/A" denotes no model name, no serial no. or no calibration specified.

All calibration period of equipment list is one year.

3.1.3 TEST PROCEDURE

- The measuring distance of 10 m shall be used for measurements. The EUT was placed on the top of a rotating table 0.8 meter above the ground at a 10 meter semi-anechoic chamber. The table was rotated 360 degrees to determine the position of the highest radiation.
- The height of the equipment or of the substitution antenna shall be 0.8 m, the height of the test antenna shall vary between 1 m to 4 m. Both horizontal and vertical polarizations of the antenna are set to make the measurement.
- The initial step in collecting radiated emission data is a receiver peak detector mode pre-scanning the measurement frequency range. Significant peaks are then marked and then Quasi Peak detector mode re-measured.
- All readings are Peak unless otherwise stated QP in column of Note. Peak denotes that the Peak reading compliance with the QP Limits and then QP Mode measurement didn't perform.
- For the actual test configuration, please refer to the related Item - EUT Test Photos.

3.1.4 DEVIATION FROM TEST STANDARD

No deviation

3.1.5 TEST SETUP

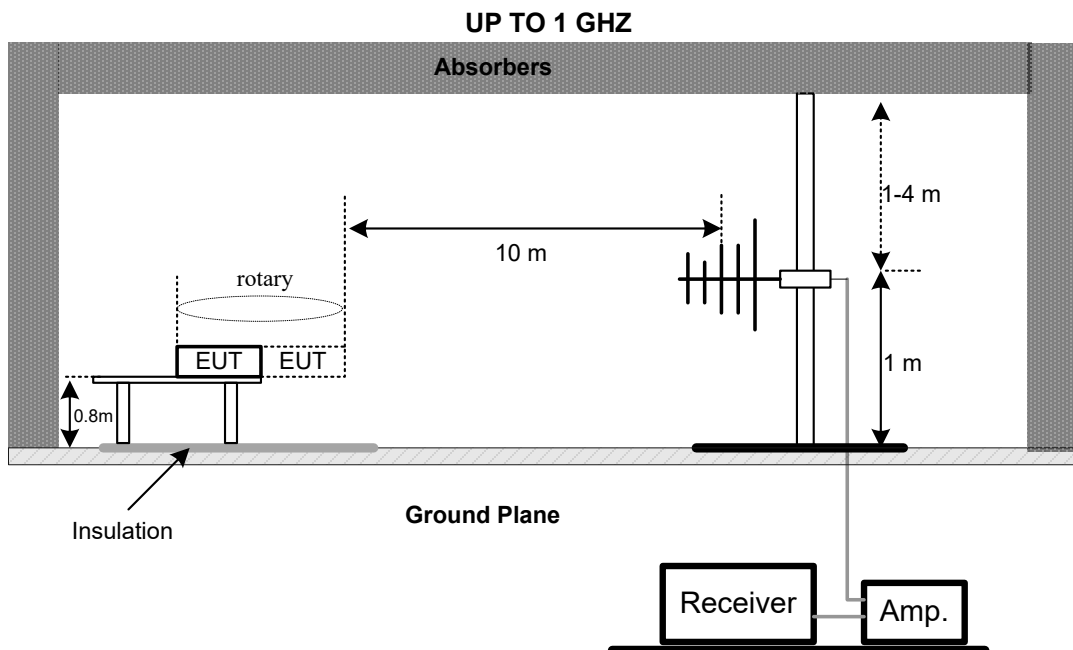

3.1.6 MEASUREMENT DISTANCE

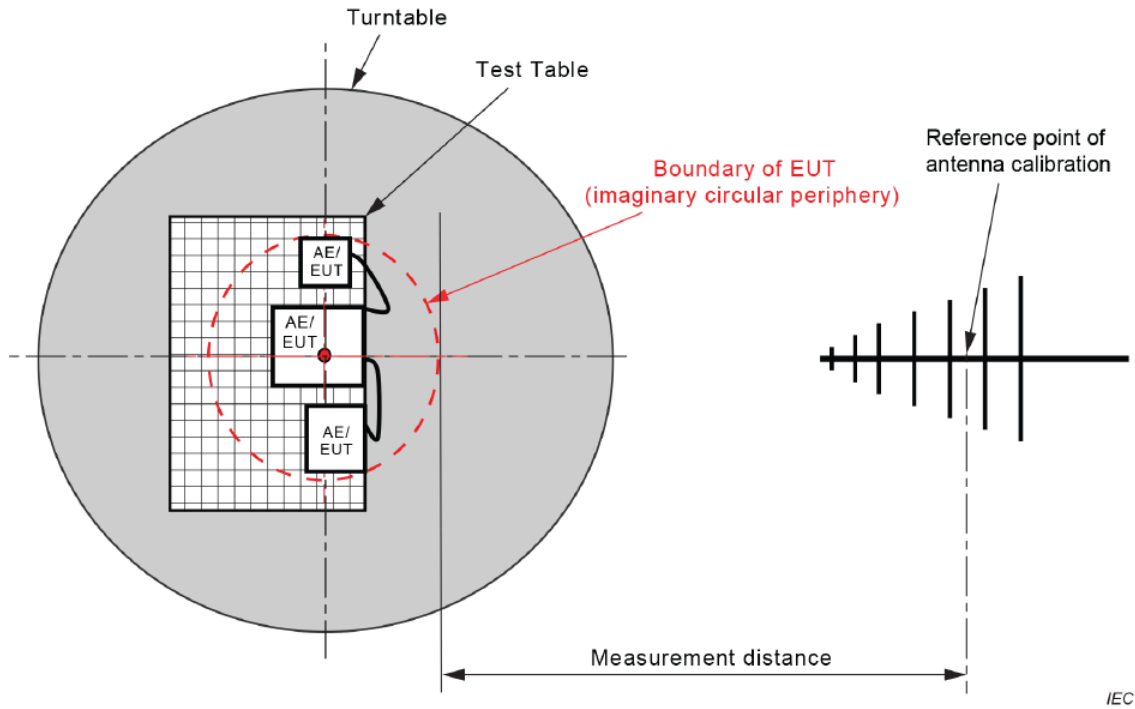

IEC

Figure C.1 – Measurement distance

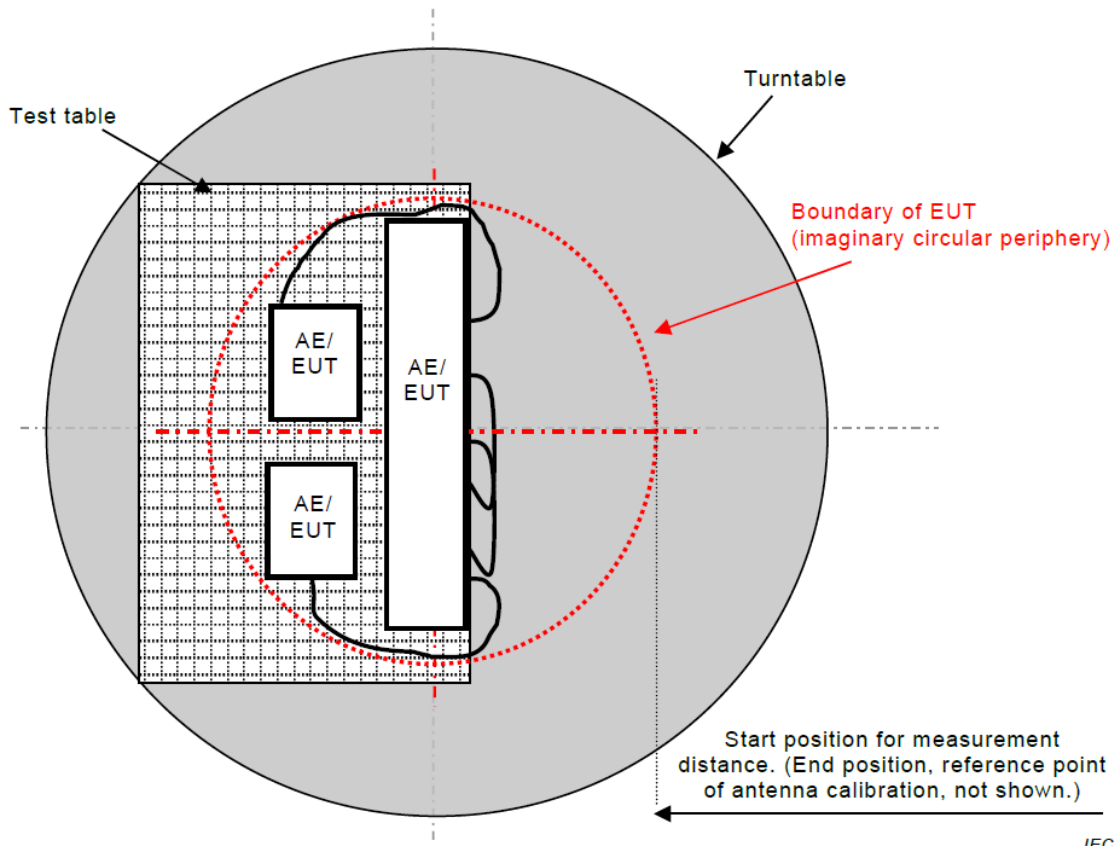

IEC

Figure C.2 – Boundary of EUT, Local AE and associated cabling

3.1.7 TEST RESULTS

Test Voltage	AC 230V/50Hz	Polarization	Vertical
Test Mode	Mode 1		

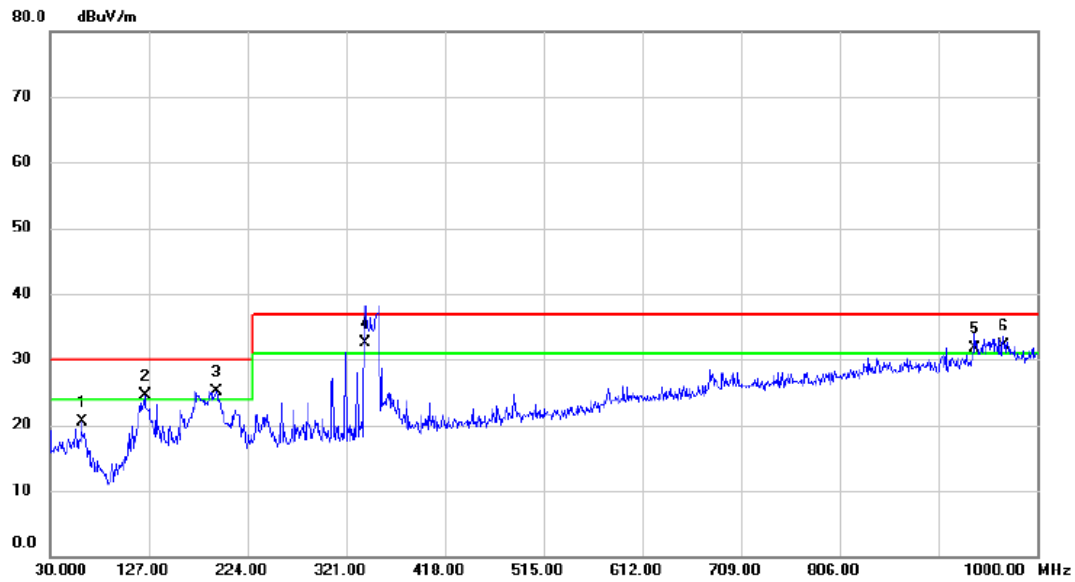

No.	Mk.	Freq. MHz	Reading Level dBuV	Correct Factor dB	Measure- ment dBuV/m	Limit dBuV/m	Margin dB	Detector	Comment
1		61.0400	37.73	-17.21	20.52	30.00	-9.48	QP	
2	!	123.1200	42.09	-17.67	24.42	30.00	-5.58	QP	
3	!	192.9600	43.09	-17.93	25.16	30.00	-4.84	QP	
4	*	339.4300	45.62	-13.13	32.49	37.00	-4.51	QP	
5	!	938.8900	34.82	-3.18	31.64	37.00	-5.36	QP	
6	!	967.0200	34.65	-2.57	32.08	37.00	-4.92	QP	

Test Voltage	AC 230V/50Hz	Polarization	Horizontal
Test Mode	Mode 1		

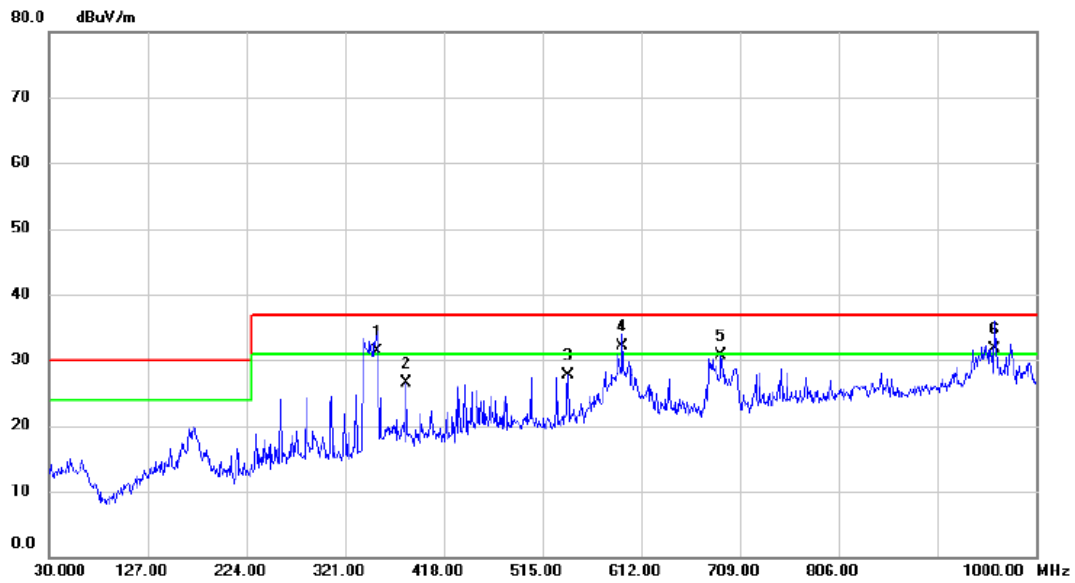

No.	Mk.	Freq. MHz	Reading Level dBuV	Correct Factor dB	Measure- ment dBuV/m	Limit dBuV/m	Margin dB	Detector	Comment
1	!	353.0100	45.71	-14.42	31.29	37.00	-5.71	QP	
2		381.1400	39.93	-13.50	26.43	37.00	-10.57	QP	
3		540.2200	38.16	-10.55	27.61	37.00	-9.39	QP	
4	*	593.5700	41.76	-9.67	32.09	37.00	-4.91	QP	
5		690.5700	39.65	-8.88	30.77	37.00	-6.23	QP	
6	!	959.7450	37.59	-5.91	31.68	37.00	-5.32	QP	

3.2 RADIATED EMISSIONS ABOVE 1 GHZ

3.2.1 LIMITS

Class B equipment above 1 GHz

Frequency Range MHz	Measurement			Class B limits dB(μ V/m)
	Facility	Distance m	Detector type/bandwidth	
1000 - 3000	FSOATS	3	Average / 1 MHz	50
3000 - 6000				54
1000 - 3000			Peak / 1 MHz	70
3000 - 6000				74

Notes:

- (1) The limit for radiated test was performed according to as following: EN 55032
- (2) The tighter limit applies at the band edges.
- (3) Emission level (dBuV/m)=20log Emission level (uV/m).
- (4) The test result calculated as following:
 Measurement Value = Reading Level + Correct Factor
 Correct Factor = Antenna Factor + Cable Loss - Amplifier Gain(if use)
 Margin Level = Measurement Value - Limit Value

Required highest frequency for radiated measurement

Highest internal frequency (F_x)	Highest measured frequency
$F_x \leq 108$ MHz	1 GHz
$108 < F_x \leq 500$ MHz	2 GHz
$500 < F_x \leq 1000$ MHz	5 GHz
$F_x > 1$ GHz	5 x F_x up to a maximum of 6 GHz

3.2.2 MEASUREMENT INSTRUMENTS LIST

Item	Kind of Equipment	Manufacturer	Type No.	Serial No.	Calibrated until
1	Horn Antenna	ETS	3115	9605-4803	Jul. 07, 2025
2	MXE EMI Receiver	Agilent	N9038A	MY53220133	Oct. 08, 2024
3	Preamplifier	EMC INSTRUMENT	EMC118A45SE	981003	Nov. 17, 2024
4	Measurement Software	Farad	EZ-EMC Ver.BTL-2ANT-1	N/A	N/A
5	Multi-Device Controller	ETS-Lindgren	2090	N/A	N/A
6	Controller	MF	MF-7802	MF780208159	N/A
7	Cable	RegalWay	RWLP50-4.0A-S MSM-9M	N/A	Sep. 02, 2025
8	Cable	RW	RWLP50-4.0A-N MRASM-1M	N/A	Sep. 02, 2025
9	Cable	RW	RWLP50-4.0A-N MRASM-4M	N/A	Sep. 02, 2025

Remark: "N/A" denotes no model name, no serial no. or no calibration specified.

All calibration period of equipment list is one year.

3.2.3 TEST PROCEDURE

- The measuring distance of 3 m shall be used for measurements. The EUT was placed on the top of a rotating table 0.8 meter above the ground at a 10 meter semi-anechoic chamber. The table was rotated 360 degrees to determine the position of the highest radiation.
- The height of the equipment or of the substitution antenna shall be 0.8 m, the height of the test antenna shall vary between 1 m to 4 m. Both horizontal and vertical polarizations of the antenna are set to make the measurement.
- The initial step in collecting radiated emission data is a receiver peak detector mode pre-scanning the measurement frequency range. Significant peaks are then marked and then AVG detector mode re-measured.
- All readings are Peak Mode value unless otherwise stated AVG in column of Note. If the Peak Mode Measured value compliance with the Peak Limits and lower than AVG Limits, the EUT shall be deemed to meet both Peak & AVG Limits and then only Peak Mode was measured, but AVG Mode didn't perform.
- For the actual test configuration, please refer to the related Item - EUT Test Photos.

3.2.4 DEVIATION FROM TEST STANDARD

No deviation

3.2.5 TEST SETUP

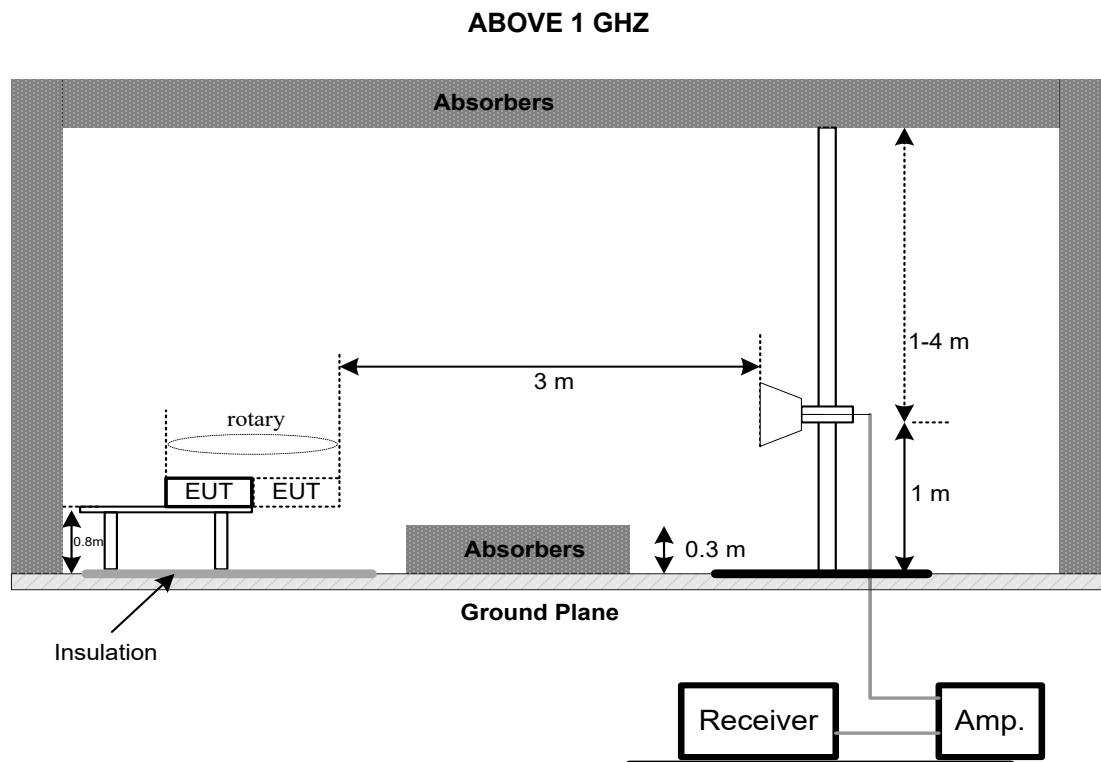

3.2.6 MEASUREMENT DISTANCE

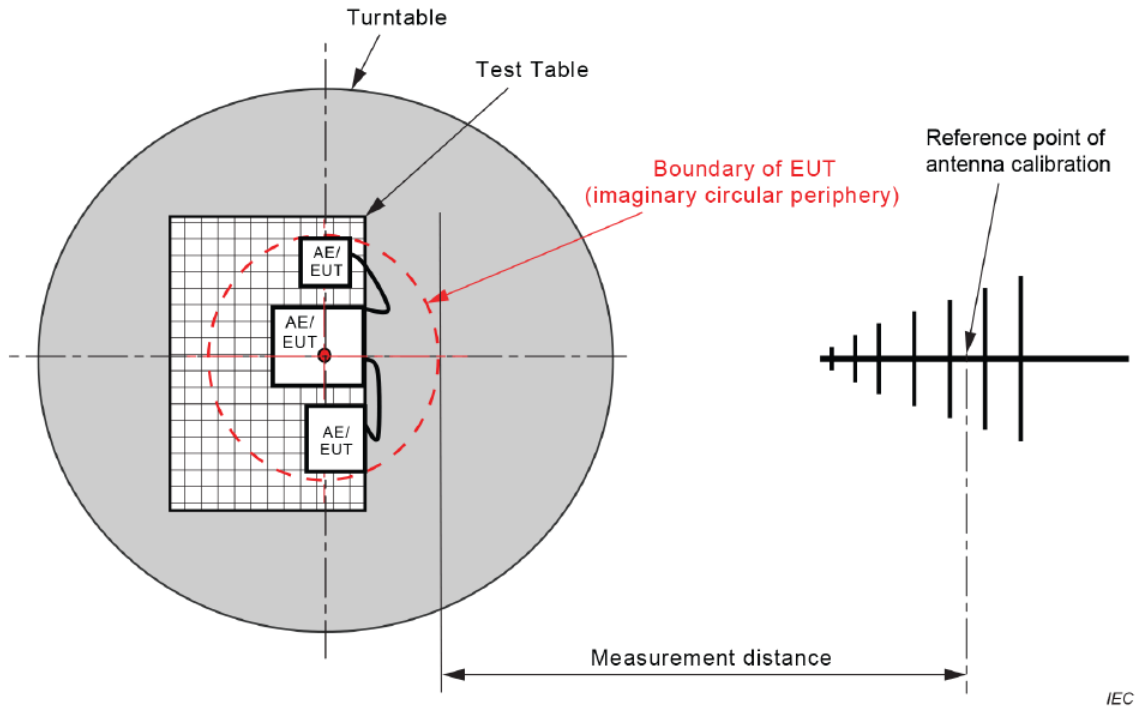

Figure C.1 – Measurement distance

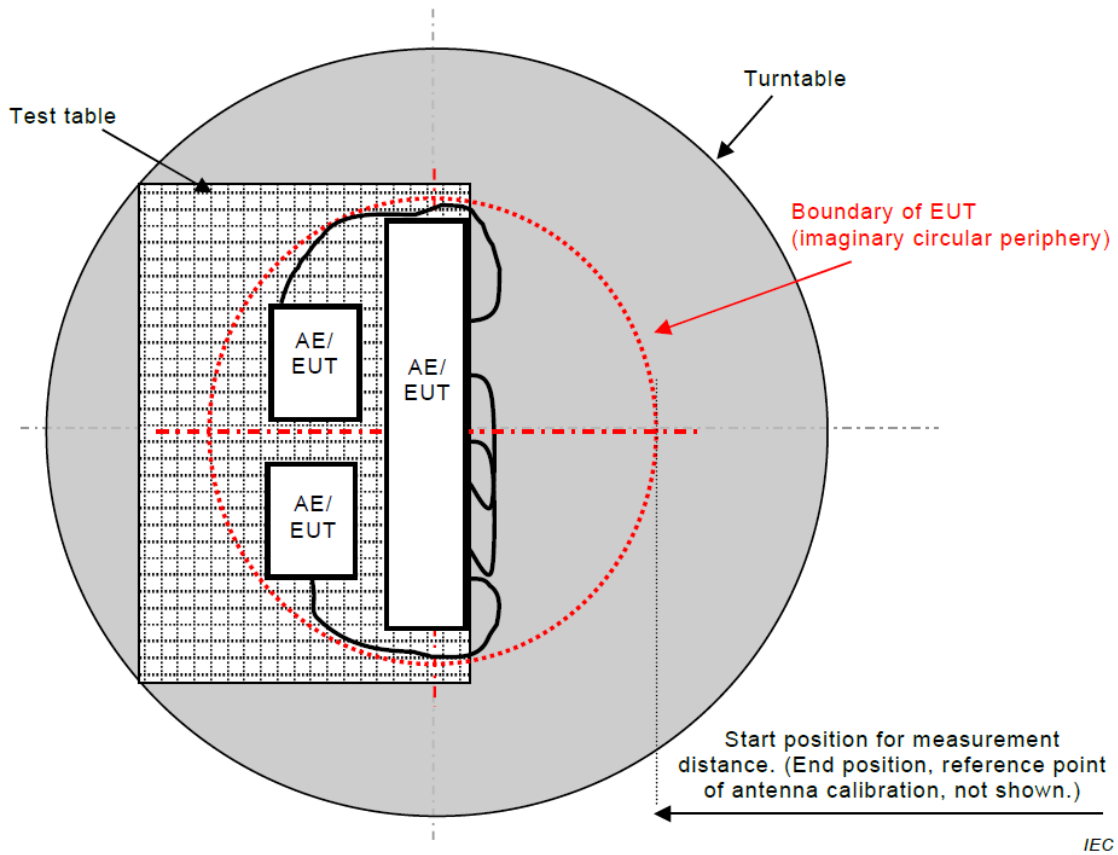
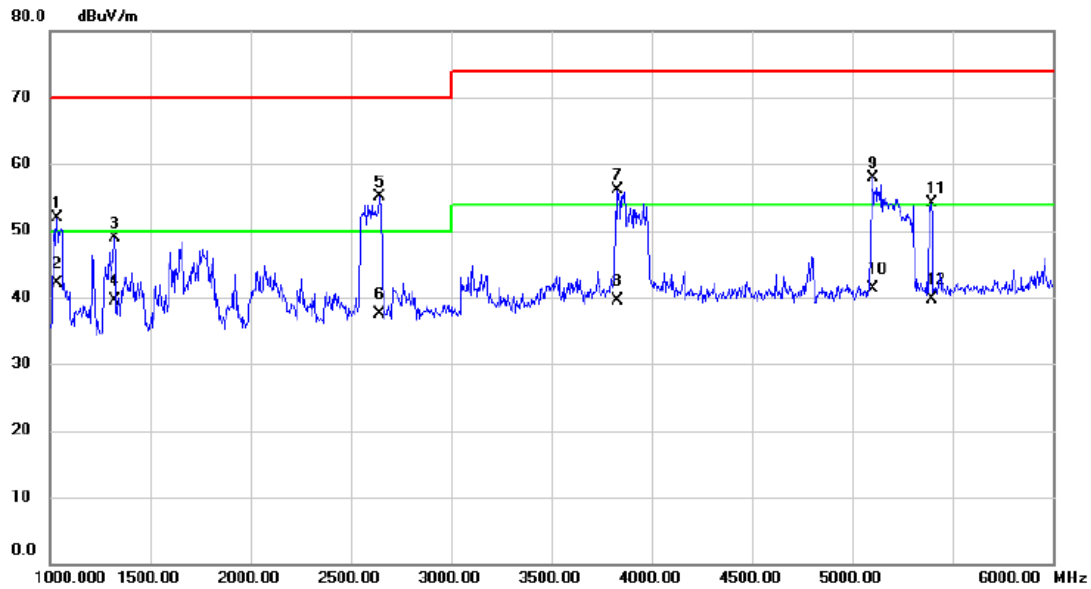

Figure C.2 – Boundary of EUT, Local AE and associated cabling

3.2.7 TEST RESULTS

Test Voltage	AC 230V/50Hz	Polarization	Vertical
Test Mode	Mode 1		



No.	Mk.	Freq. MHz	Reading Level dBuV	Correct Factor dB	Measure- ment dBuV/m	Limit dBuV/m	Margin dB	Detector	Comment
1		1037.500	57.99	-6.08	51.91	70.00	-18.09	peak	
2	*	1037.500	48.15	-6.08	42.07	50.00	-7.93	AVG	
3		1320.000	54.32	-5.32	49.00	70.00	-21.00	peak	
4		1320.000	44.92	-5.32	39.60	50.00	-10.40	AVG	
5		2640.000	56.18	-1.12	55.06	70.00	-14.94	peak	
6		2640.000	38.65	-1.12	37.53	50.00	-12.47	AVG	
7		3832.500	53.86	2.20	56.06	74.00	-17.94	peak	
8		3832.500	37.39	2.20	39.59	54.00	-14.41	AVG	
9		5102.500	54.59	3.29	57.88	74.00	-16.12	peak	
10		5102.500	38.01	3.29	41.30	54.00	-12.70	AVG	
11		5395.000	50.36	3.74	54.10	74.00	-19.90	peak	
12		5395.000	35.93	3.74	39.67	54.00	-14.33	AVG	

Test Voltage	AC 230V/50Hz	Polarization	Horizontal
Test Mode	Mode 1		

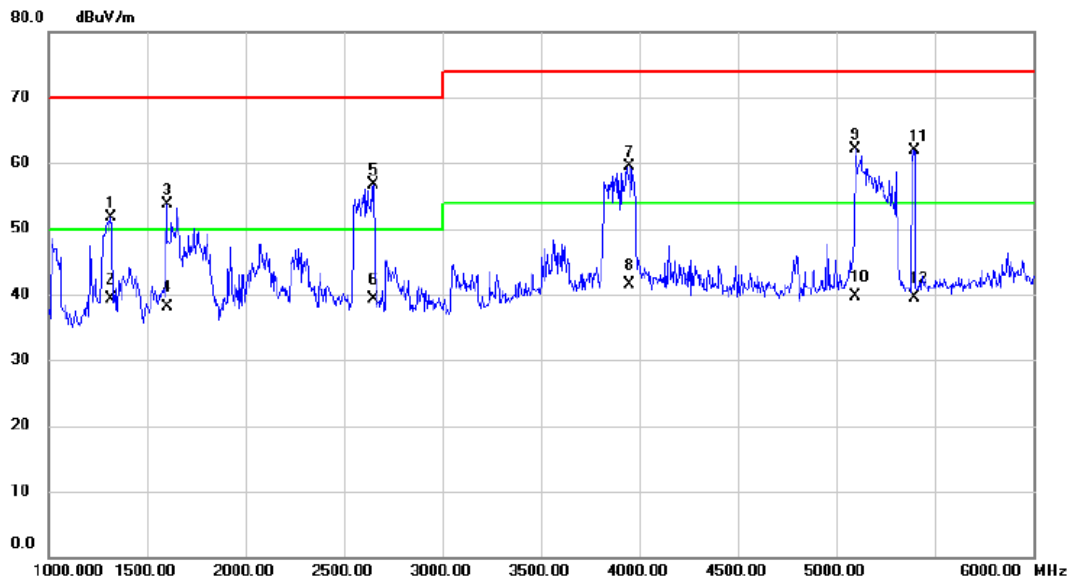

No.	Mk.	Freq. MHz	Reading Level dBuV	Correct Factor dB	Measure- ment dBuV/m	Limit dBuV/m	Margin dB	Detector	Comment
1		1315.000	57.13	-5.33	51.80	70.00	-18.20	peak	
2	*	1315.000	44.69	-5.33	39.36	50.00	-10.64	AVG	
3		1600.000	58.16	-4.43	53.73	70.00	-16.27	peak	
4		1600.000	42.60	-4.43	38.17	50.00	-11.83	AVG	
5		2652.500	57.71	-1.08	56.63	70.00	-13.37	peak	
6		2652.500	40.35	-1.08	39.27	50.00	-10.73	AVG	
7		3950.000	56.91	2.52	59.43	74.00	-14.57	peak	
8		3950.000	39.08	2.52	41.60	54.00	-12.40	AVG	
9		5097.500	58.88	3.28	62.16	74.00	-11.84	peak	
10		5097.500	36.48	3.28	39.76	54.00	-14.24	AVG	
11		5395.000	58.20	3.74	61.94	74.00	-12.06	peak	
12		5395.000	35.85	3.74	39.59	54.00	-14.41	AVG	

3.3 CONDUCTED EMISSION MEASUREMENT AT AC MAINS POWER PORTS

3.3.1 LIMITS

Requirements for conducted emissions from AC mains power ports of Class B equipment

Frequency Range MHz	Coupling Device	Detector Type / bandwidth	Class B Limits (dB(μV))
0.15 - 0.5	AMN	Quasi Peak / 9 kHz	66-56
0.5 - 5			56
5 - 30			60
0.15 - 0.5	AMN	Average / 9 kHz	56-46
0.5 - 5			46
5 - 30			50

NOTE:

(1) The test result calculated as following:

Measurement Value = Reading Level + Correct Factor

Correct Factor = Insertion Loss + Cable Loss + Attenuator Factor(if use)

Margin Level = Measurement Value – Limit Value

3.3.2 MEASUREMENT INSTRUMENTS LIST

Item	Kind of Equipment	Manufacturer	Type No.	Serial No.	Calibrated until
1	EMI TEST RECEIVER	R&S	ESCI	100382	Dec. 22, 2024
2	TWO-LINE V-NETWORK	R&S	ENV216	10274	Dec. 22, 2024
3	TWO-LINE V-NETWORK	R&S	ENV216	101447	Dec. 22, 2024
4	Measurement Software	Farad	EZ-EMC Ver.NB-03A1-01	N/A	N/A
5	Cable	N/A	SFT205-NMNM-9M -001	9M	Nov. 27, 2024

Remark: "N/A" denotes no model name, no serial no. or no calibration specified.

All calibration period of equipment list is one year.

3.3.3 TEST PROCEDURE

- a. The EUT was placed 0.8 meters from the horizontal ground plane with EUT being connected to the power mains through a line impedance stabilization network (LISN). All other support equipment powered from additional LISN(s). The LISN provide 50 Ohm/ 50uH of coupling impedance for the measuring instrument.
- b. Interconnecting cables that hang closer than 40 cm to the ground plane shall be folded back and forth in the center forming a bundle 30 to 40 cm long.
- c. I/O cables that are not connected to a peripheral shall be bundled in the center. The end of the cable may be terminated, if required, using the correct terminating impedance. The overall length shall not exceed 1 m.
- d. LISN at least 80 cm from nearest part of EUT chassis.
- e. For the actual test configuration, please refer to the related Item –EUT Test Photos.

3.3.4 DEVIATION FROM TEST STANDARD

No deviation

3.3.5 TEST SETUP

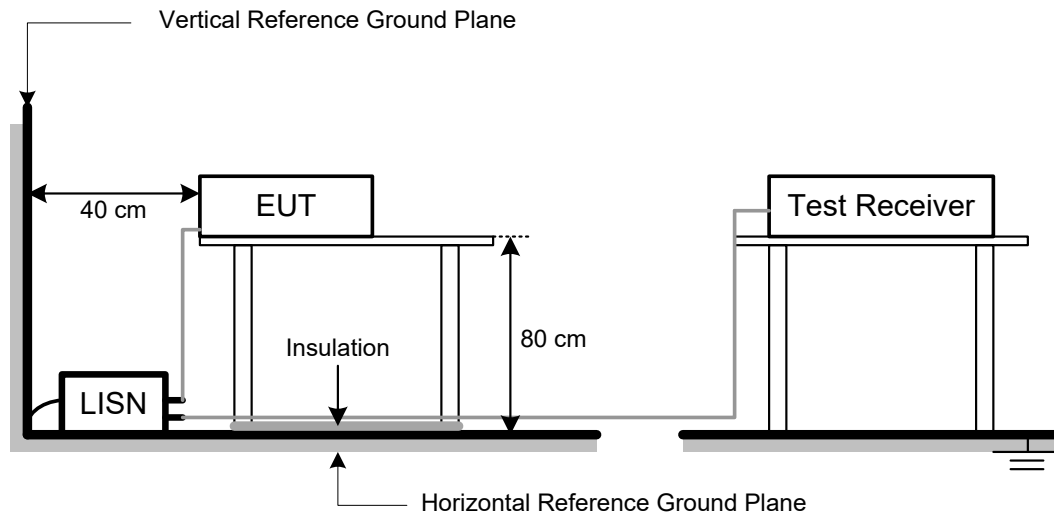

3.3.6 TEST RESULTS

Test Voltage	AC 230V/50Hz	Phase	Line
Test Mode	Mode 1		

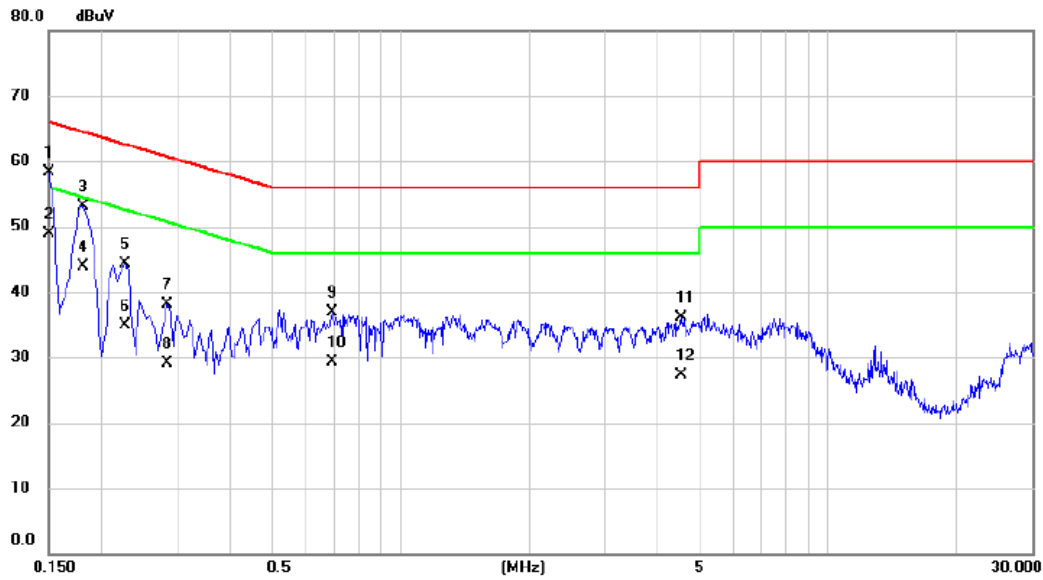

No.	Mk.	Freq. MHz	Reading Level dBuV	Correct Factor dB	Measure- ment dBuV	Limit dBuV	Margin dB	Detector	Comment
1		0.1500	48.62	9.73	58.35	66.00	-7.65	QP	
2	*	0.1500	39.20	9.73	48.93	56.00	-7.07	AVG	
3		0.1815	43.42	9.74	53.16	64.42	-11.26	QP	
4		0.1815	34.10	9.74	43.84	54.42	-10.58	AVG	
5		0.2265	34.59	9.75	44.34	62.58	-18.24	QP	
6		0.2265	25.10	9.75	34.85	52.58	-17.73	AVG	
7		0.2850	28.35	9.77	38.12	60.67	-22.55	QP	
8		0.2850	19.30	9.77	29.07	50.67	-21.60	AVG	
9		0.6944	27.10	9.80	36.90	56.00	-19.10	QP	
10		0.6944	19.50	9.80	29.30	46.00	-16.70	AVG	
11		4.5420	26.14	9.98	36.12	56.00	-19.88	QP	
12		4.5420	17.30	9.98	27.28	46.00	-18.72	AVG	

Test Voltage	AC 230V/50Hz	Phase	Neutral
Test Mode	Mode 1		

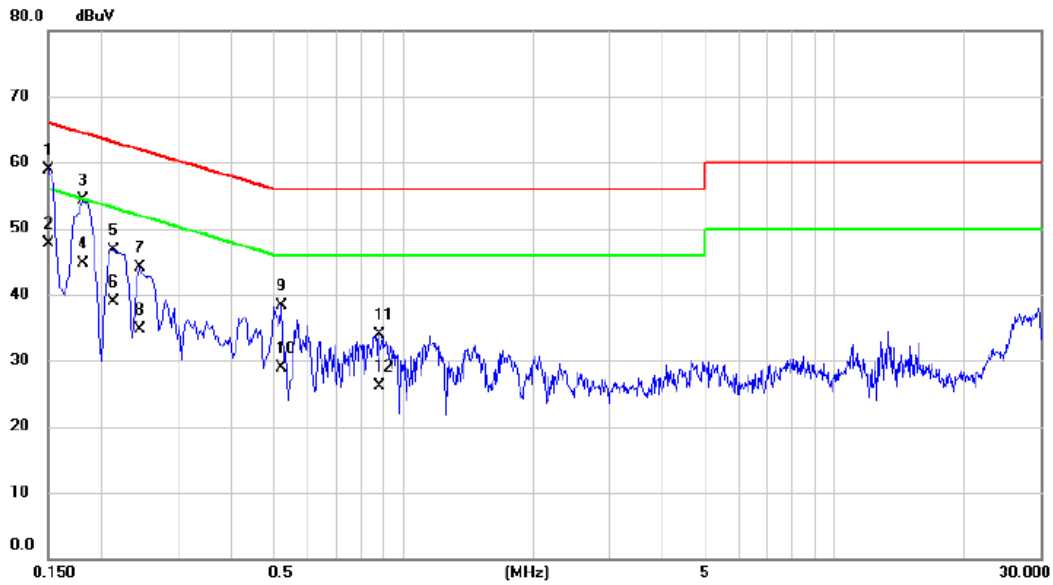

No.	Mk.	Freq. MHz	Reading Level dBuV	Correct Factor dB	Measure- ment dBuV	Limit dBuV	Margin dB	Detector	Comment
1	*	0.1500	49.27	9.58	58.85	66.00	-7.15	QP	
2		0.1500	38.20	9.58	47.78	56.00	-8.22	AVG	
3		0.1815	44.64	9.59	54.23	64.42	-10.19	QP	
4		0.1815	35.10	9.59	44.69	54.42	-9.73	AVG	
5		0.2130	37.12	9.60	46.72	63.09	-16.37	QP	
6		0.2130	29.30	9.60	38.90	53.09	-14.19	AVG	
7		0.2445	34.48	9.61	44.09	61.94	-17.85	QP	
8		0.2445	25.10	9.61	34.71	51.94	-17.23	AVG	
9		0.5234	28.67	9.65	38.32	56.00	-17.68	QP	
10		0.5234	19.30	9.65	28.95	46.00	-17.05	AVG	
11		0.8790	24.22	9.67	33.89	56.00	-22.11	QP	
12		0.8790	16.40	9.67	26.07	46.00	-19.93	AVG	

4. EMC EMISSION TEST- EN 55032:2015+A11:2020

4.1 RADIATED EMISSIONS UP TO 1 GHZ

4.1.1 LIMITS

Class B equipment up to 1 GHz

Frequency Range MHz	Measurement			Class B limits dB(μV/m)
	Facility	Distance m	Detector type/ bandwidth	
30 - 230	SAC	10	Quasi peak / 120 kHz	30
230 - 1000				37

Notes:

- (1) The limit for radiated test was performed according to as following: EN 55032
- (2) The tighter limit applies at the band edges.
- (3) Emission level (dBuV/m)=20log Emission level (uV/m).
- (4) The test result calculated as following:
 Measurement Value = Reading Level + Correct Factor
 Correct Factor = Antenna Factor + Cable Loss - Amplifier Gain(if use)
 Margin Level = Measurement Value - Limit Value

4.1.2 MEASUREMENT INSTRUMENTS LIST

Item	Kind of Equipment	Manufacturer	Type No.	Serial No.	Calibrated until
1	Receiver	Keysight	N9038A	MY54450004	Jun. 01, 2025
2	MXE EMI Receiver	Agilent	N9038A	MY53220133	Jun. 01, 2025
3	Pre-Amplifier	EMC INSTRUMENT	EMC 9135	980284	May 31, 2025
4	Pre-Amplifier	EMC INSTRUMENT	EMC 9135	980283	May 31, 2025
5	Trilog-Broadband Antenna	Schwarzbeck	VULB9168	947	Nov. 10, 2024
6	Attenuator	EMCI	EMCI-N-6-06	AT-N0670	Nov. 10, 2024
7	Trilog-Broadband Antenna	Schwarzbeck	VULB9168	1461	Nov. 28, 2024
8	Attenuator	EMC INSTRUMENT	EMCI-N-6-06	AT-06010	Nov. 28, 2024
9	Measurement Software	Farad	EZ-EMC Ver.BTL-2ANT-1	N/A	N/A
10	Multi-Device Controller	ETS-Lindgren	2090	N/A	N/A
11	Controller	MF	MF-7802	MF780208159	N/A
12	Cable	RW	LMR400-NMNM-10M	N/A	Dec. 03, 2024
13	Cable	RW	LMR400-NMNM-7M	N/A	Dec. 03, 2024
14	Cable	RW	LMR400-NMNM-3.5M	N/A	Dec. 03, 2024
15	Cable	RW	LMR400-NMNM-7M	N/A	Sep. 04, 2025
16	Cable	RW	LMR400-NMNM-8M	N/A	Sep. 04, 2025
17	Cable	RW	LMR400-NMNM-3.5M	N/A	Sep. 04, 2025

Remark: "N/A" denotes no model name, no serial no. or no calibration specified.

All calibration period of equipment list is one year.

4.1.3 TEST PROCEDURE

- The measuring distance of 10 m shall be used for measurements. The EUT was placed on the top of a rotating table 0.8 meter above the ground at a 10 meter semi-anechoic chamber. The table was rotated 360 degrees to determine the position of the highest radiation.
- The height of the equipment or of the substitution antenna shall be 0.8 m, the height of the test antenna shall vary between 1 m to 4 m. Both horizontal and vertical polarizations of the antenna are set to make the measurement.
- The initial step in collecting radiated emission data is a receiver peak detector mode pre-scanning the measurement frequency range. Significant peaks are then marked and then Quasi Peak detector mode re-measured.
- All readings are Peak unless otherwise stated QP in column of Note. Peak denotes that the Peak reading compliance with the QP Limits and then QP Mode measurement didn't perform.
- For the actual test configuration, please refer to the related Item - EUT Test Photos.

4.1.4 DEVIATION FROM TEST STANDARD

No deviation

4.1.5 TEST SETUP

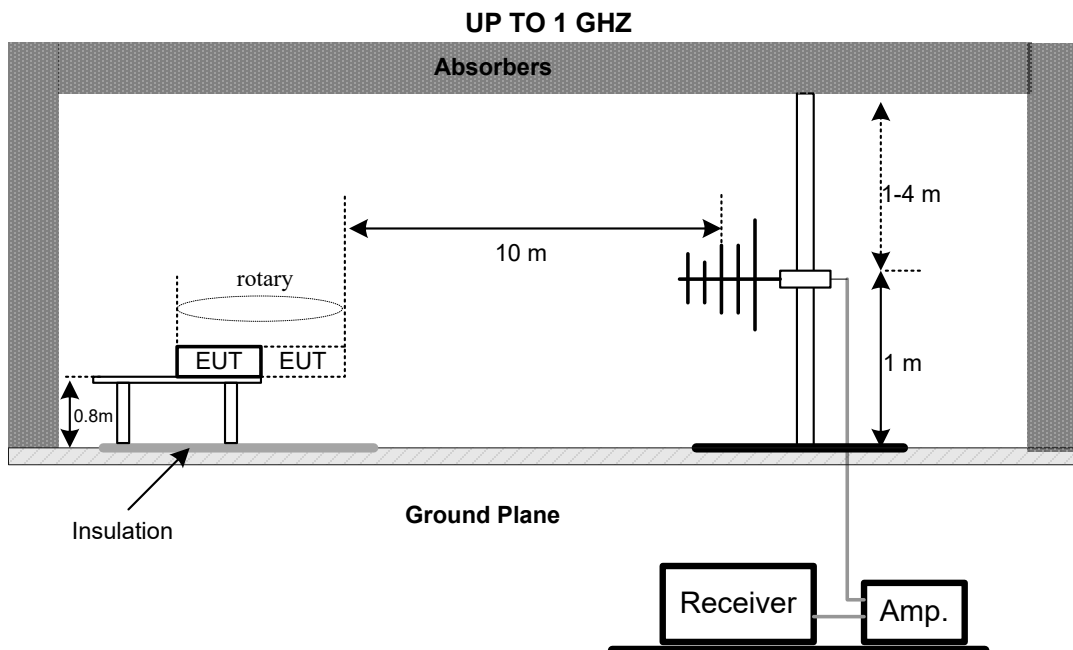

4.1.6 MEASUREMENT DISTANCE

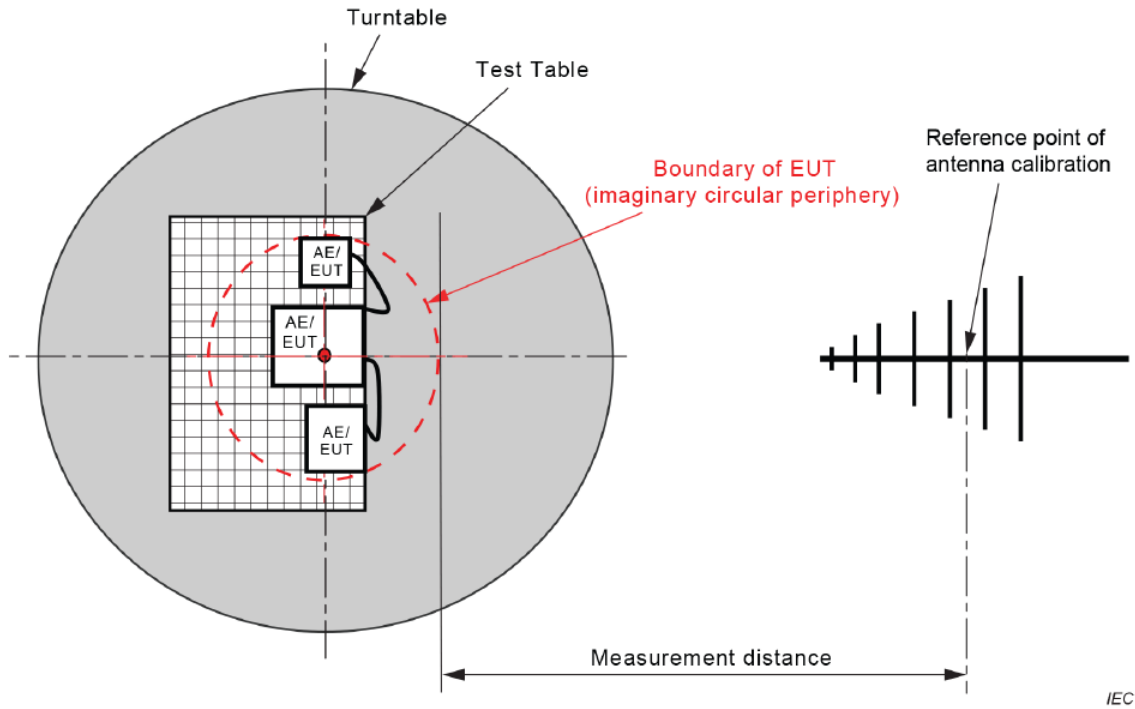

IEC

Figure C.1 – Measurement distance

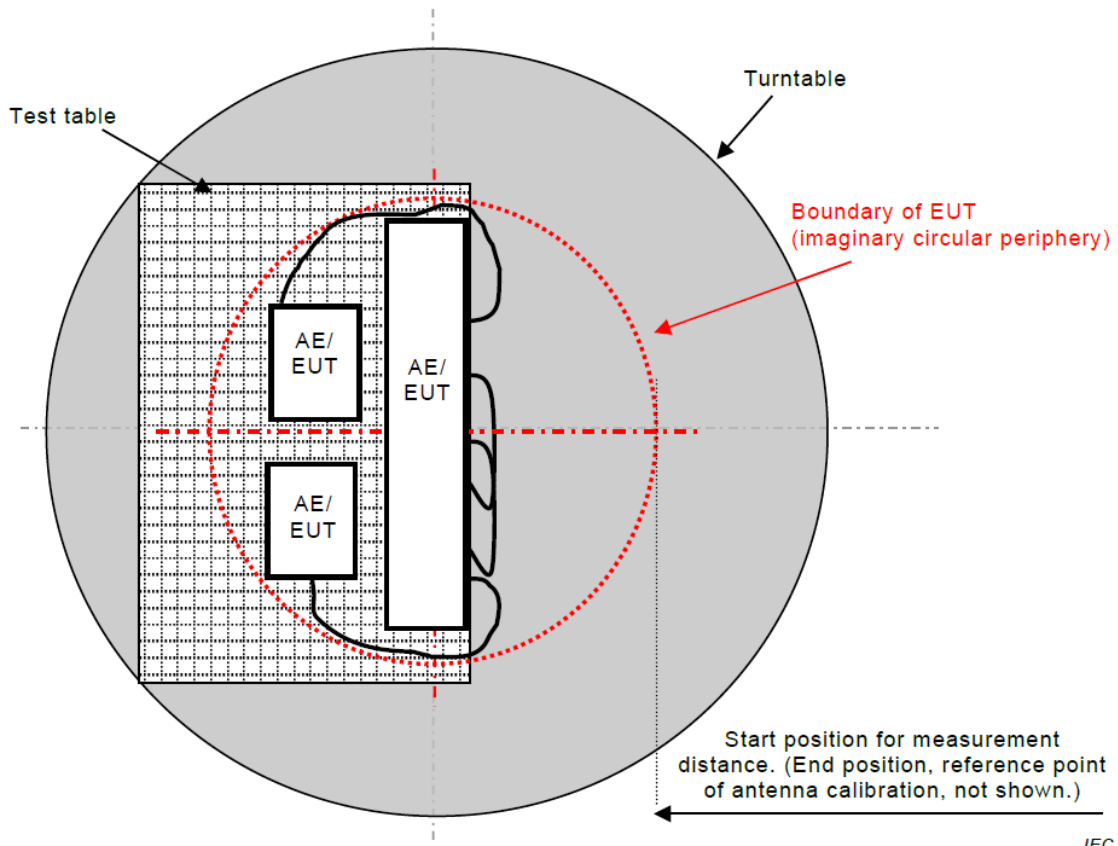

IEC

Figure C.2 – Boundary of EUT, Local AE and associated cabling

4.1.7 TEST RESULTS

Test Voltage	AC 230V/50Hz	Polarization	Vertical
Test Mode	Mode 1		

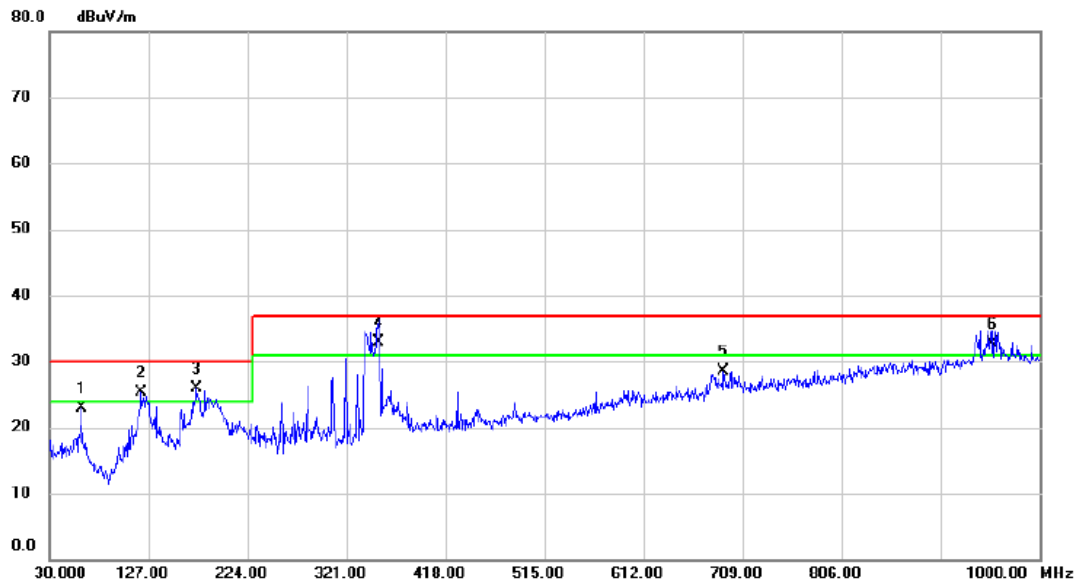

No.	Mk.	Freq. MHz	Reading Level dBuV	Correct Factor dB	Measure- ment dBuV/m	Limit dBuV/m	Margin dB	Detector	Comment
1		61.0400	40.11	-17.21	22.90	30.00	-7.10	QP	
2	!	120.2100	43.20	-17.93	25.27	30.00	-4.73	QP	
3	!	174.5300	41.75	-15.88	25.87	30.00	-4.13	QP	
4	*	352.0400	46.05	-13.07	32.98	37.00	-4.02	QP	
5		690.5700	34.74	-6.24	28.50	37.00	-8.50	QP	
6	!	953.4400	35.65	-2.89	32.76	37.00	-4.24	QP	

Test Voltage	AC 230V/50Hz	Polarization	Horizontal
Test Mode	Mode 1		

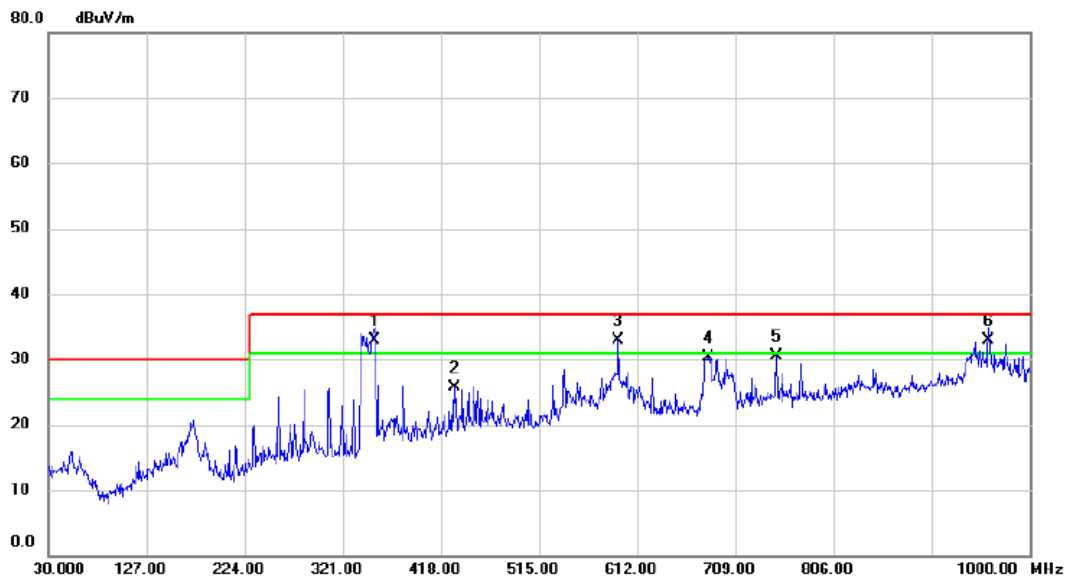

No.	Mk.	Freq. MHz	Reading Level dBuV	Correct Factor dB	Measure- ment dBuV/m	Limit dBuV/m	Margin dB	Detector	Comment
1	*	353.0100	47.33	-14.42	32.91	37.00	-4.09	QP	
2		431.5800	38.08	-12.36	25.72	37.00	-11.28	QP	
3	!	593.5700	42.51	-9.67	32.84	37.00	-4.16	QP	
4		682.8100	39.27	-8.89	30.38	37.00	-6.62	QP	
5		749.7400	38.12	-7.71	30.41	37.00	-6.59	QP	
6	!	959.2600	38.79	-5.91	32.88	37.00	-4.12	QP	

Test Voltage	AC 230V/50Hz	Polarization	Vertical
Test Mode	Mode 4		

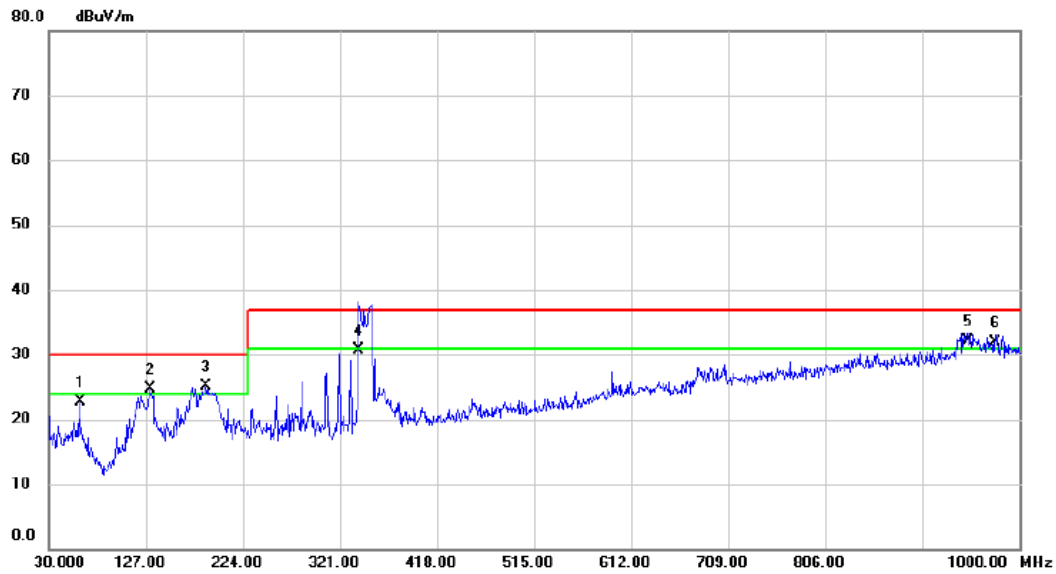

No.	Mk.	Freq. MHz	Reading Level dBuV	Correct Factor dB	Measure- ment dBuV/m	Limit dBuV/m	Margin dB	Detector	Comment
1		61.0400	39.98	-17.21	22.77	30.00	-7.23	QP	
2	!	131.3650	41.55	-16.92	24.63	30.00	-5.37	QP	
3	!	187.1400	42.61	-17.51	25.10	30.00	-4.90	QP	
4		339.4300	43.81	-13.13	30.68	37.00	-6.32	QP	
5	*	948.5900	35.19	-3.00	32.19	37.00	-4.81	QP	
6	!	975.7500	34.26	-2.37	31.89	37.00	-5.11	QP	

Test Voltage	AC 230V/50Hz	Polarization	Horizontal
Test Mode	Mode 4		

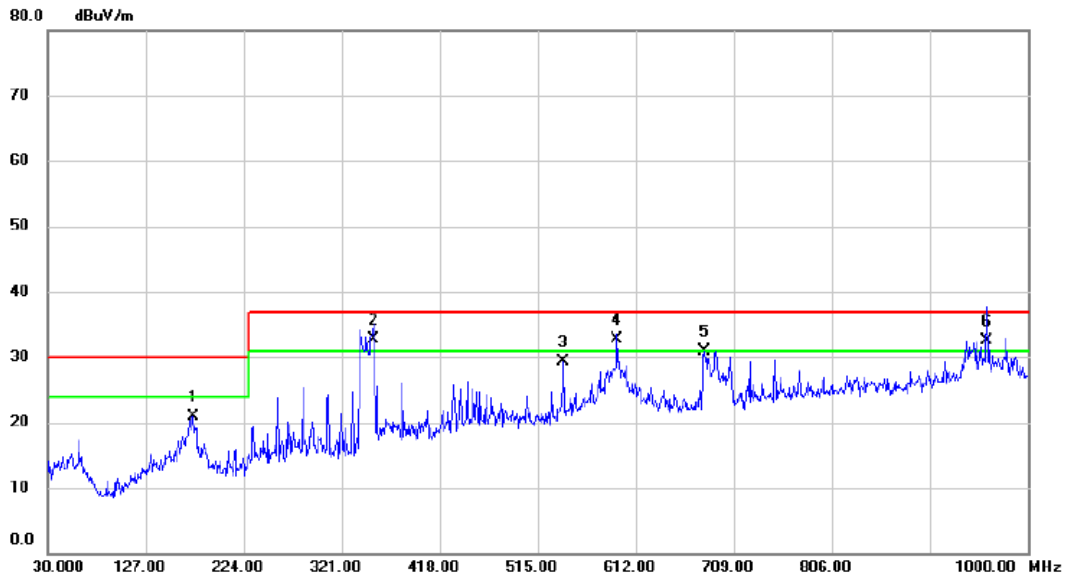

No.	Mk.	Freq. MHz	Reading Level dBuV	Correct Factor dB	Measure- ment dBuV/m	Limit dBuV/m	Margin dB	Detector	Comment
1		173.5600	38.45	-17.59	20.86	30.00	-9.14	QP	
2	!	352.0400	47.11	-14.45	32.66	37.00	-4.34	QP	
3		540.2200	39.77	-10.55	29.22	37.00	-7.78	QP	
4	*	593.5700	42.38	-9.67	32.71	37.00	-4.29	QP	
5		679.9000	39.74	-8.90	30.84	37.00	-6.16	QP	
6	!	959.2600	38.33	-5.91	32.42	37.00	-4.58	QP	

Test Voltage	AC 230V/50Hz	Polarization	Vertical
Test Mode	Mode 5		

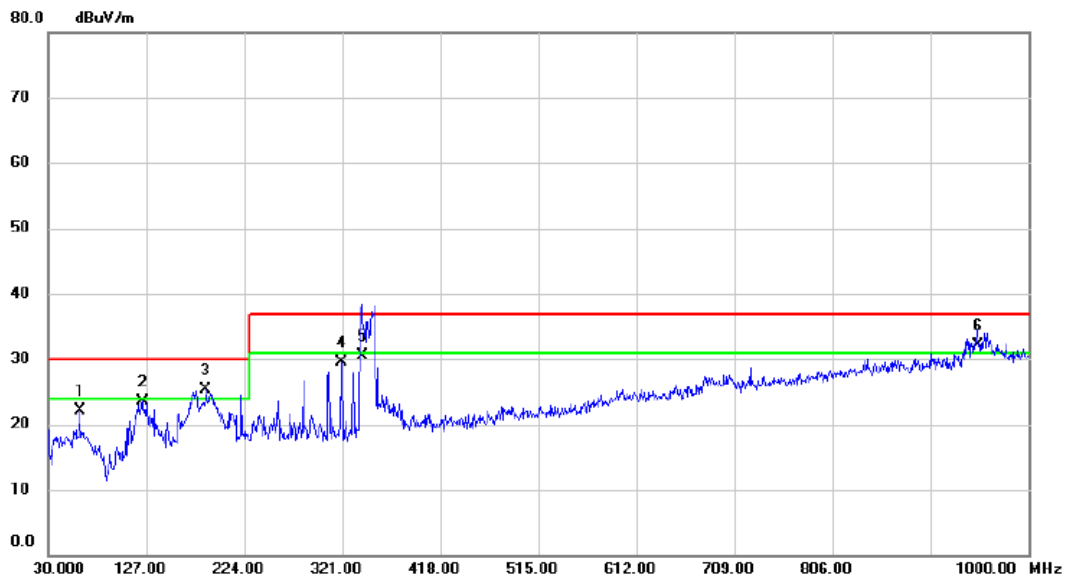

No.	Mk.	Freq. MHz	Reading Level dBuV	Correct Factor dB	Measure- ment dBuV/m	Limit dBuV/m	Margin dB	Detector	Comment
1		61.0400	39.34	-17.21	22.13	30.00	-7.87	QP	
2		123.1200	41.19	-17.67	23.52	30.00	-6.48	QP	
3	*	186.1700	42.78	-17.39	25.39	30.00	-4.61	QP	
4		320.0300	42.97	-13.53	29.44	37.00	-7.56	QP	
5		340.4000	43.61	-13.11	30.50	37.00	-6.50	QP	
6	!	949.5600	35.16	-2.97	32.19	37.00	-4.81	QP	

Test Voltage	AC 230V/50Hz	Polarization	Horizontal
Test Mode	Mode 5		

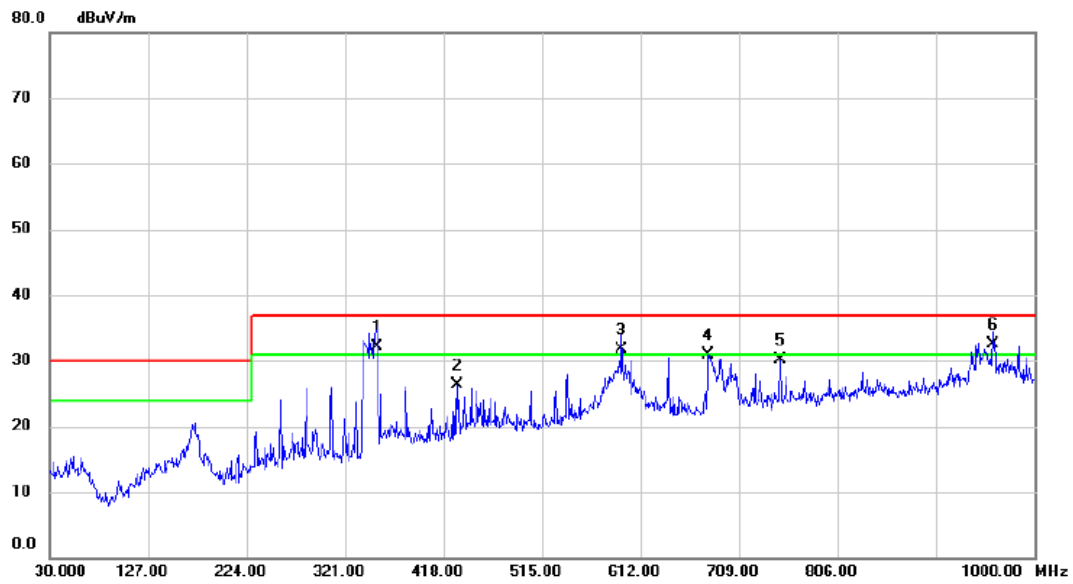

No.	Mk.	Freq. MHz	Reading Level dBuV	Correct Factor dB	Measure- ment dBuV/m	Limit dBuV/m	Margin dB	Detector	Comment
1	!	353.0100	46.49	-14.42	32.07	37.00	-4.93	QP	
2		431.5800	38.64	-12.36	26.28	37.00	-10.72	QP	
3	!	593.5700	41.43	-9.67	31.76	37.00	-5.24	QP	
4		678.9300	39.78	-8.89	30.89	37.00	-6.11	QP	
5		749.7400	37.80	-7.71	30.09	37.00	-6.91	QP	
6	*	959.2600	38.39	-5.91	32.48	37.00	-4.52	QP	

Test Voltage	AC 230V/50Hz	Polarization	Vertical
Test Mode	Mode 15		

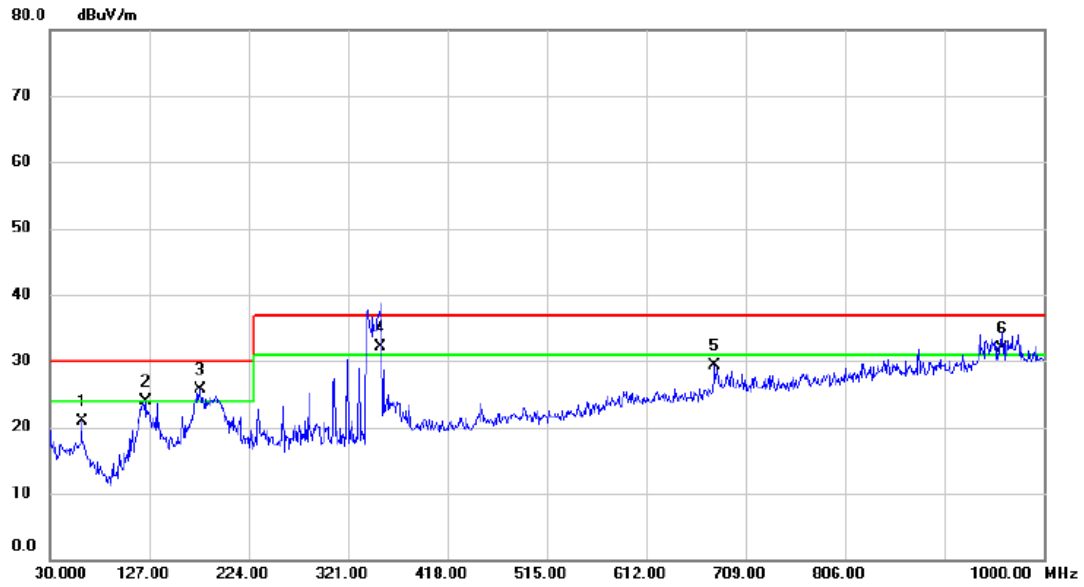

No.	Mk.	Freq. MHz	Reading Level dBuV	Correct Factor dB	Measure- ment dBuV/m	Limit dBuV/m	Margin dB	Detector	Comment
1		61.0400	38.11	-17.21	20.90	30.00	-9.10	QP	
2		123.1200	41.59	-17.67	23.92	30.00	-6.08	QP	
3	*	176.4700	41.92	-16.14	25.78	30.00	-4.22	QP	
4	!	353.0100	45.11	-13.04	32.07	37.00	-4.93	QP	
5		678.9300	35.71	-6.44	29.27	37.00	-7.73	QP	
6	!	959.2600	34.62	-2.75	31.87	37.00	-5.13	QP	

Test Voltage	AC 230V/50Hz	Polarization	Horizontal
Test Mode	Mode 15		

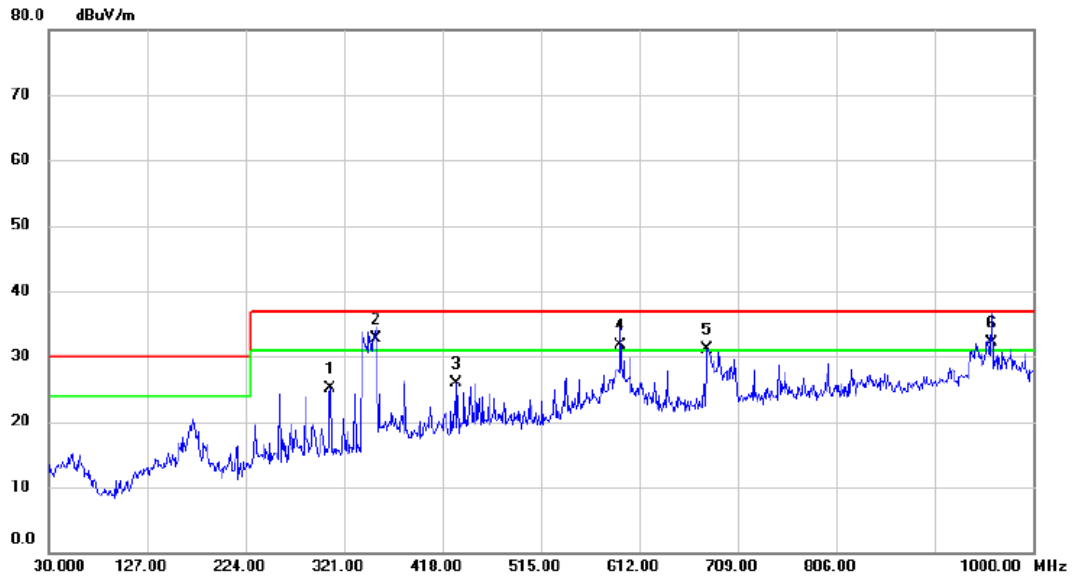

No.	Mk.	Freq. MHz	Reading Level dBuV	Correct Factor dB	Measure- ment dBuV/m	Limit dBuV/m	Margin dB	Detector	Comment
1		307.4200	40.62	-15.53	25.09	37.00	-11.91	QP	
2	*	353.0100	47.07	-14.42	32.65	37.00	-4.35	QP	
3		431.5800	38.35	-12.36	25.99	37.00	-11.01	QP	
4	!	593.5700	41.40	-9.67	31.73	37.00	-5.27	QP	
5	!	678.9300	40.01	-8.89	31.12	37.00	-5.88	QP	
6	!	959.7450	38.00	-5.91	32.09	37.00	-4.91	QP	

Test Voltage	AC 110V/60Hz	Polarization	Vertical
Test Mode	Mode 1		

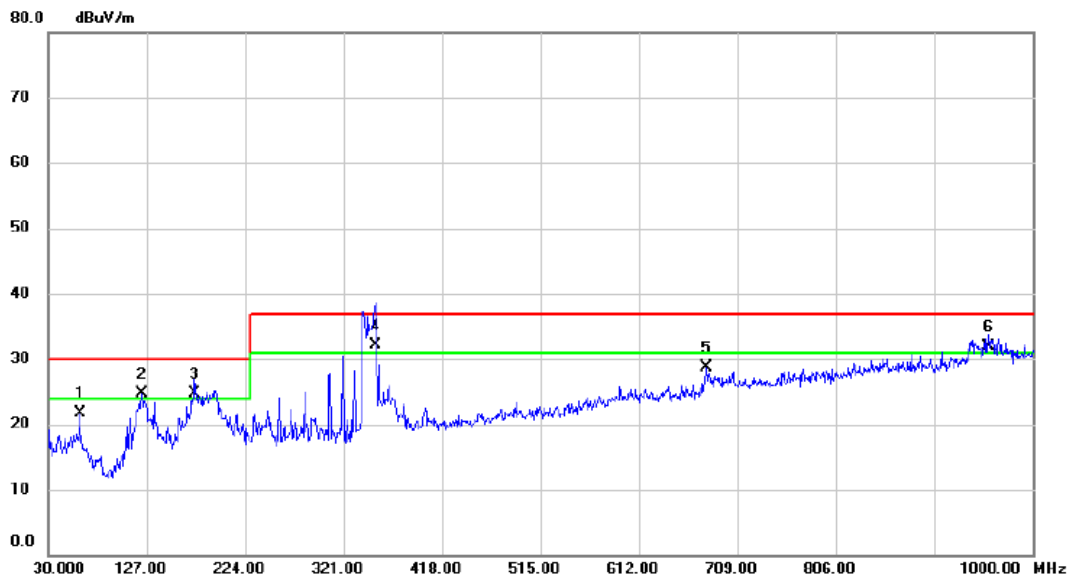

No.	Mk.	Freq. MHz	Reading Level dBuV	Correct Factor dB	Measure- ment dBuV/m	Limit dBuV/m	Margin dB	Detector	Comment
1		61.0400	38.95	-17.21	21.74	30.00	-8.26	QP	
2	!	122.1500	42.37	-17.75	24.62	30.00	-5.38	QP	
3	!	174.5300	40.57	-15.88	24.69	30.00	-5.31	QP	
4	*	352.0400	45.14	-13.07	32.07	37.00	-4.93	QP	
5		678.9300	35.21	-6.44	28.77	37.00	-8.23	QP	
6	!	956.3500	34.67	-2.83	31.84	37.00	-5.16	QP	

Test Voltage	AC 110V/60Hz	Polarization	Horizontal
Test Mode	Mode 1		

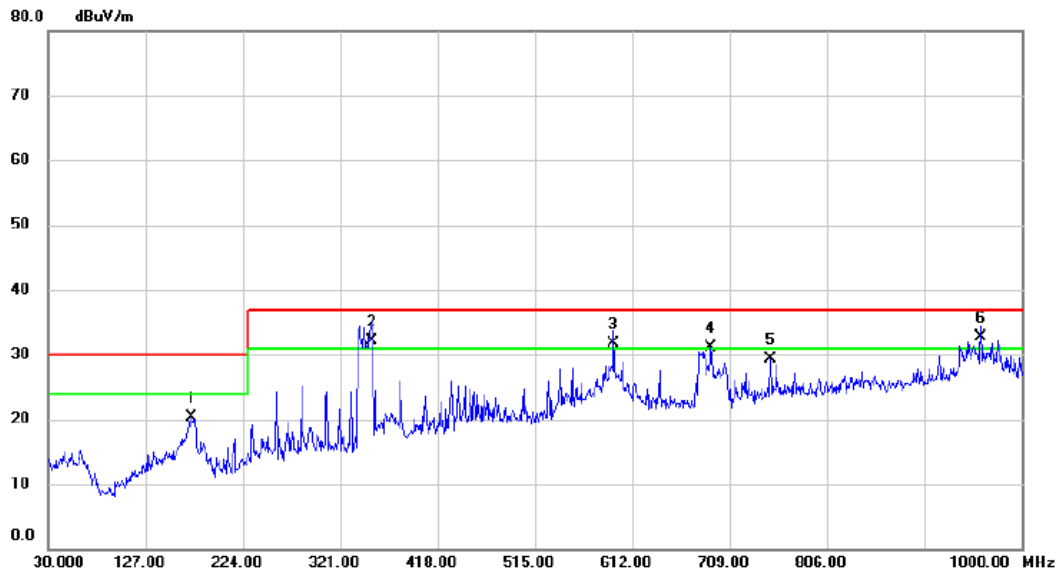

No.	Mk.	Freq. MHz	Reading Level dBuV	Correct Factor dB	Measure- ment dBuV/m	Limit dBuV/m	Margin dB	Detector	Comment
1		172.5900	37.73	-17.50	20.23	30.00	-9.77	QP	
2	!	353.0100	46.46	-14.42	32.04	37.00	-4.96	QP	
3	!	593.5700	41.34	-9.67	31.67	37.00	-5.33	QP	
4	!	690.5700	39.89	-8.88	31.01	37.00	-5.99	QP	
5		749.7400	37.00	-7.71	29.29	37.00	-7.71	QP	
6	*	959.7450	38.67	-5.91	32.76	37.00	-4.24	QP	

4.2 RADIATED EMISSIONS ABOVE 1 GHZ

4.2.1 LIMITS

Class B equipment above 1 GHz

Frequency Range MHz	Measurement			Class B limits dB(μ V/m)
	Facility	Distance m	Detector type/bandwidth	
1000 - 3000	FSOATS	3	Average / 1 MHz	50
3000 - 6000				54
1000 - 3000			Peak / 1 MHz	70
3000 - 6000				74

Notes:

- (1) The limit for radiated test was performed according to as following: EN 55032
- (2) The tighter limit applies at the band edges.
- (3) Emission level (dBuV/m)=20log Emission level (uV/m).
- (4) The test result calculated as following:
 Measurement Value = Reading Level + Correct Factor
 Correct Factor = Antenna Factor + Cable Loss - Amplifier Gain(if use)
 Margin Level = Measurement Value - Limit Value

Required highest frequency for radiated measurement

Highest internal frequency (F_x)	Highest measured frequency
$F_x \leq 108$ MHz	1 GHz
$108 < F_x \leq 500$ MHz	2 GHz
$500 < F_x \leq 1000$ MHz	5 GHz
$F_x > 1$ GHz	5 x F_x up to a maximum of 6 GHz

4.2.2 MEASUREMENT INSTRUMENTS LIST

Item	Kind of Equipment	Manufacturer	Type No.	Serial No.	Calibrated until
1	Horn Antenna	ETS	3115	9605-4803	Jul. 07, 2025
2	MXE EMI Receiver	Agilent	N9038A	MY53220133	Oct. 08, 2024
3	Preamplifier	EMC INSTRUMENT	EMC118A45SE	981003	Nov. 17, 2024
4	Measurement Software	Farad	EZ-EMC Ver.BTL-2ANT-1	N/A	N/A
5	Multi-Device Controller	ETS-Lindgren	2090	N/A	N/A
6	Controller	MF	MF-7802	MF780208159	N/A
7	Cable	RegalWay	RWLP50-4.0A-S MSM-9M	N/A	Sep. 02, 2025
8	Cable	RW	RWLP50-4.0A-N MRASM-1M	N/A	Sep. 02, 2025
9	Cable	RW	RWLP50-4.0A-N MRASM-4M	N/A	Sep. 02, 2025

Remark: "N/A" denotes no model name, no serial no. or no calibration specified.

All calibration period of equipment list is one year.

4.2.3 TEST PROCEDURE

- The measuring distance of 3 m shall be used for measurements. The EUT was placed on the top of a rotating table 0.8 meter above the ground at a 10 meter semi-anechoic chamber. The table was rotated 360 degrees to determine the position of the highest radiation.
- The height of the equipment or of the substitution antenna shall be 0.8 m, the height of the test antenna shall vary between 1 m to 4 m. Both horizontal and vertical polarizations of the antenna are set to make the measurement.
- The initial step in collecting radiated emission data is a receiver peak detector mode pre-scanning the measurement frequency range. Significant peaks are then marked and then AVG detector mode re-measured.
- All readings are Peak Mode value unless otherwise stated AVG in column of Note. If the Peak Mode Measured value compliance with the Peak Limits and lower than AVG Limits, the EUT shall be deemed to meet both Peak & AVG Limits and then only Peak Mode was measured, but AVG Mode didn't perform.
- For the actual test configuration, please refer to the related Item - EUT Test Photos.

4.2.4 DEVIATION FROM TEST STANDARD

The limit of the EN 55032:2015+A1:2020&AS/NZS CISPR 32:2015+AMD1:2020&CISPR 32:2015+AMD1:2019 standard deviates from the requirements, but the limit of the EN 55032:2015+A11:2020 standard is more stringent and can be covered, so the test data meets the EN 55032:2015+A1:2020 &AS/NZS CISPR 32:2015+AMD1:2020&CISPR 32:2015+AMD1:2019 standard.

4.2.5 TEST SETUP

ABOVE 1 GHZ

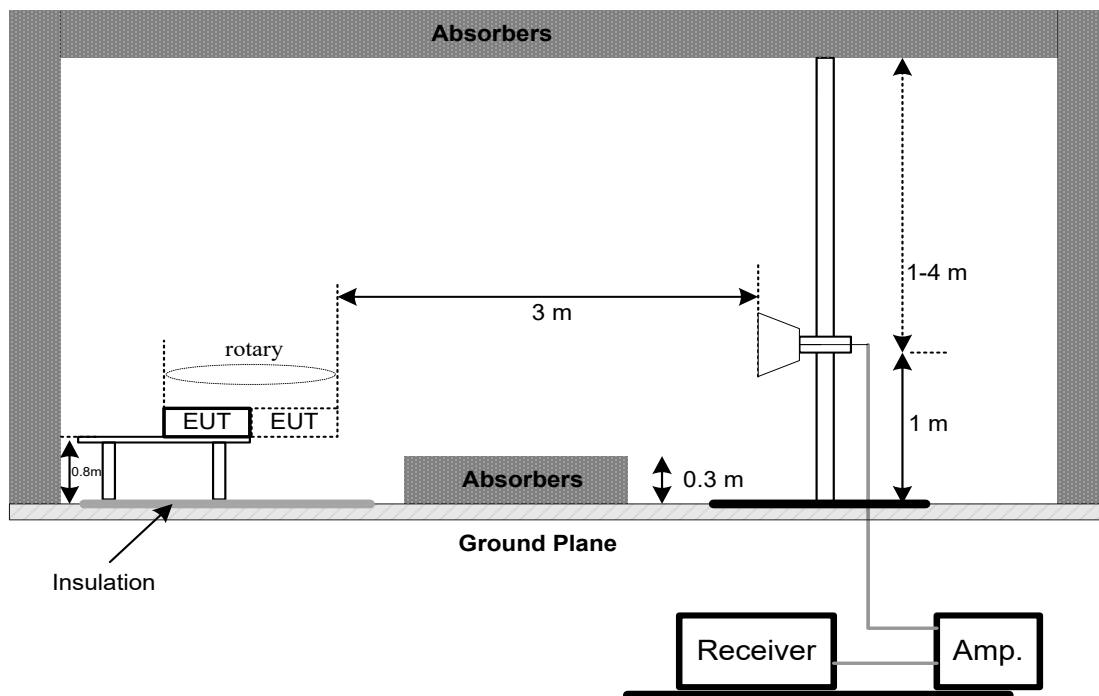

4.2.6 MEASUREMENT DISTANCE

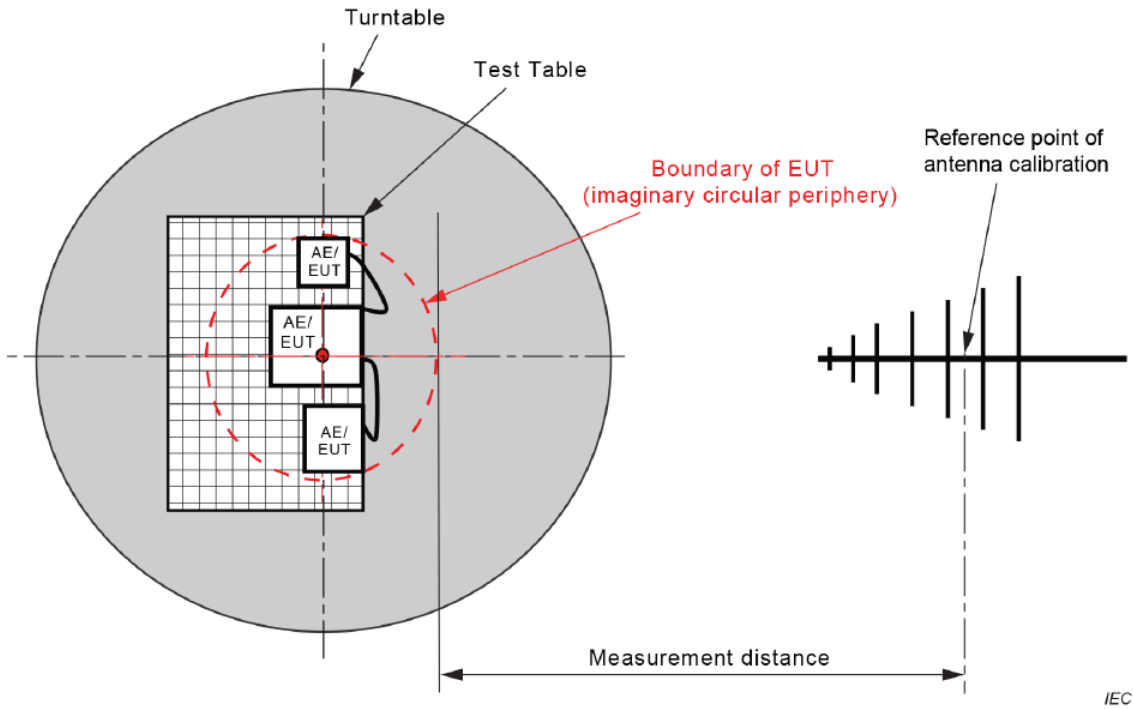

IEC

Figure C.1 – Measurement distance

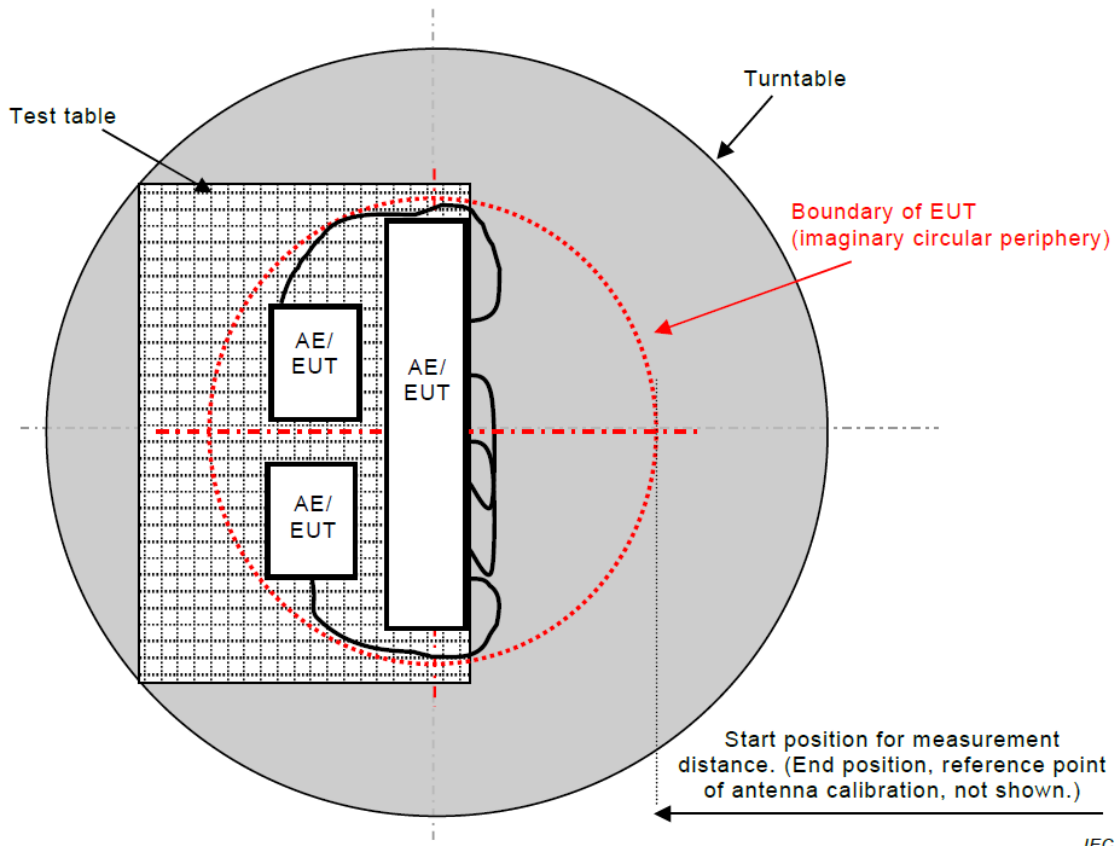

IEC

Figure C.2 – Boundary of EUT, Local AE and associated cabling

4.2.7 TEST RESULTS

Test Voltage	AC 230V/50Hz	Polarization	Vertical
Test Mode	Mode 1		

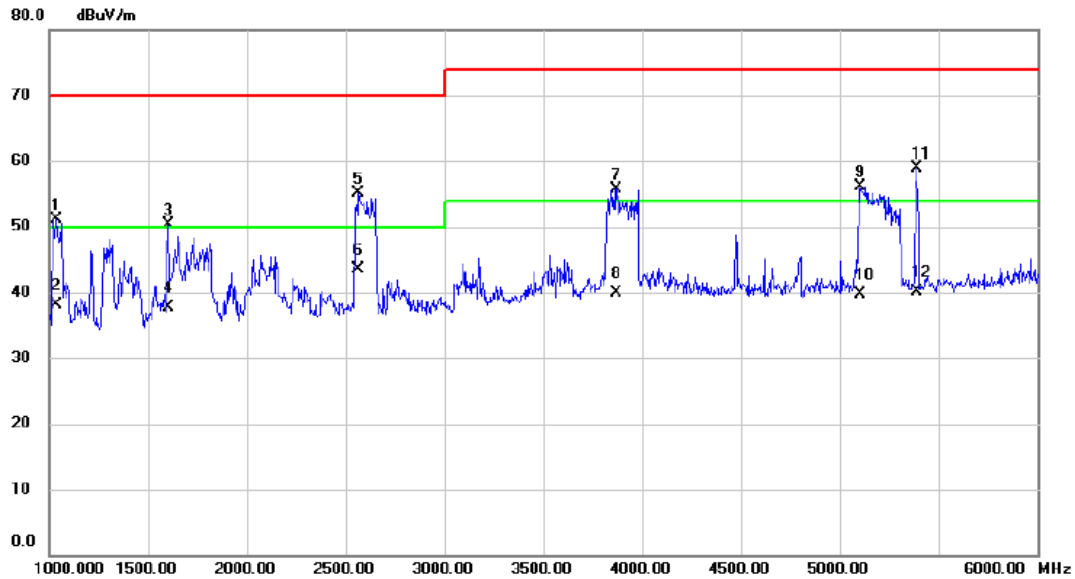

No.	Mk.	Freq. MHz	Reading Level dBuV	Correct Factor dB	Measure- ment dBuV/m	Limit dBuV/m	Margin dB	Detector	Comment
1		1037.500	57.17	-6.08	51.09	70.00	-18.91	peak	
2		1037.500	44.18	-6.08	38.10	50.00	-11.90	AVG	
3		1600.000	54.80	-4.43	50.37	70.00	-19.63	peak	
4		1600.000	42.04	-4.43	37.61	50.00	-12.39	AVG	
5		2565.000	56.43	-1.39	55.04	70.00	-14.96	peak	
6	*	2565.000	44.99	-1.39	43.60	50.00	-6.40	AVG	
7		3872.500	53.37	2.31	55.68	74.00	-18.32	peak	
8		3872.500	37.59	2.31	39.90	54.00	-14.10	AVG	
9		5105.000	52.80	3.29	56.09	74.00	-17.91	peak	
10		5105.000	36.37	3.29	39.66	54.00	-14.34	AVG	
11		5390.000	55.16	3.73	58.89	74.00	-15.11	peak	
12		5390.000	36.34	3.73	40.07	54.00	-13.93	AVG	

Test Voltage	AC 230V/50Hz	Polarization	Horizontal
Test Mode	Mode 1		

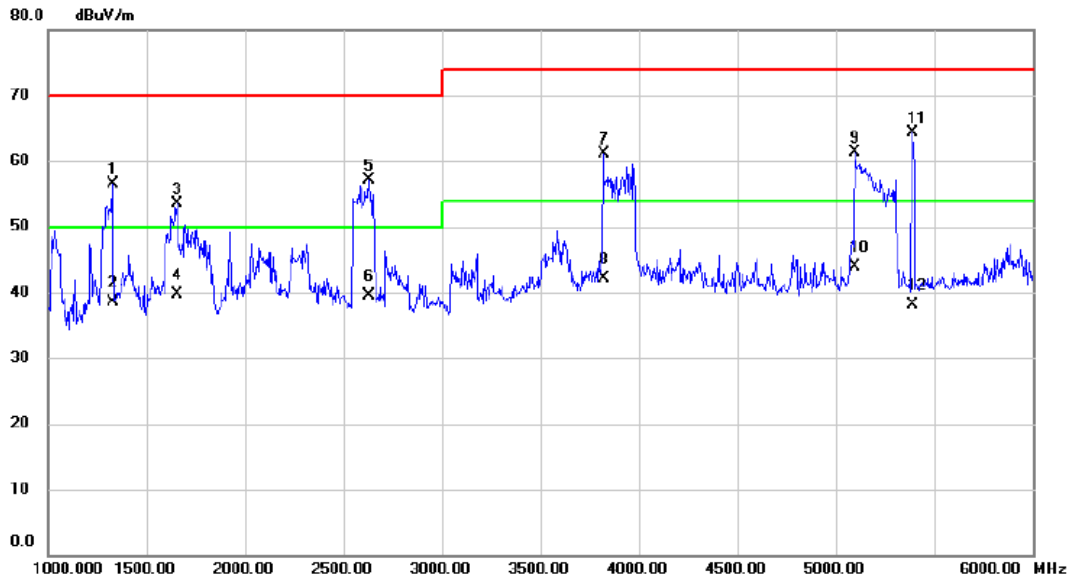

No.	Mk.	Freq. MHz	Reading Level dBuV	Correct Factor dB	Measure- ment dBuV/m	Limit dBuV/m	Margin dB	Detector	Comment
1		1327.500	61.83	-5.30	56.53	70.00	-13.47	peak	
2		1327.500	43.80	-5.30	38.50	50.00	-11.50	AVG	
3		1655.000	57.65	-4.19	53.46	70.00	-16.54	peak	
4		1655.000	43.85	-4.19	39.66	50.00	-10.34	AVG	
5		2632.500	58.17	-1.16	57.01	70.00	-12.99	peak	
6		2632.500	40.63	-1.16	39.47	50.00	-10.53	AVG	
7		3822.500	58.97	2.17	61.14	74.00	-12.86	peak	
8		3822.500	39.90	2.17	42.07	54.00	-11.93	AVG	
9		5097.500	57.99	3.28	61.27	74.00	-12.73	peak	
10		5097.500	40.62	3.28	43.90	54.00	-10.10	AVG	
11	*	5390.000	60.66	3.73	64.39	74.00	-9.61	peak	
12		5390.000	34.47	3.73	38.20	54.00	-15.80	AVG	

Test Voltage	AC 230V/50Hz	Polarization	Vertical
Test Mode	Mode 4		

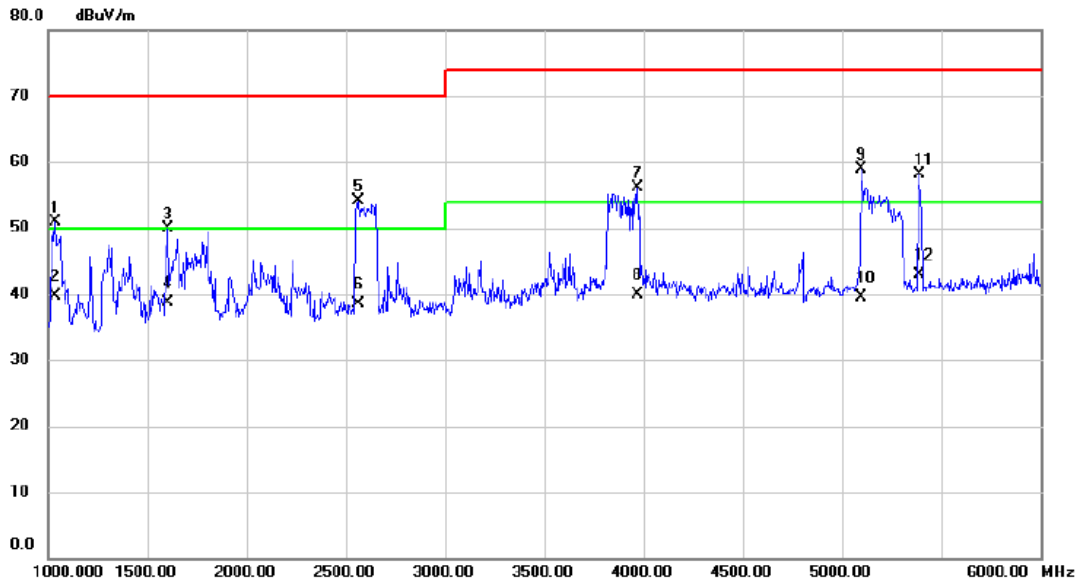

No.	Mk.	Freq. MHz	Reading Level dBuV	Correct Factor dB	Measure- ment dBuV/m	Limit dBuV/m	Margin dB	Detector	Comment
1		1035.000	57.04	-6.09	50.95	70.00	-19.05	peak	
2	*	1035.000	45.75	-6.09	39.66	50.00	-10.34	AVG	
3		1600.000	54.34	-4.43	49.91	70.00	-20.09	peak	
4		1600.000	43.04	-4.43	38.61	50.00	-11.39	AVG	
5		2565.000	55.55	-1.39	54.16	70.00	-15.84	peak	
6		2565.000	39.88	-1.39	38.49	50.00	-11.51	AVG	
7		3970.000	53.55	2.56	56.11	74.00	-17.89	peak	
8		3970.000	37.31	2.56	39.87	54.00	-14.13	AVG	
9		5097.500	55.55	3.28	58.83	74.00	-15.17	peak	
10		5097.500	36.31	3.28	39.59	54.00	-14.41	AVG	
11		5390.000	54.35	3.73	58.08	74.00	-15.92	peak	
12		5390.000	39.26	3.73	42.99	54.00	-11.01	AVG	

Test Voltage	AC 230V/50Hz	Polarization	Horizontal
Test Mode	Mode 4		

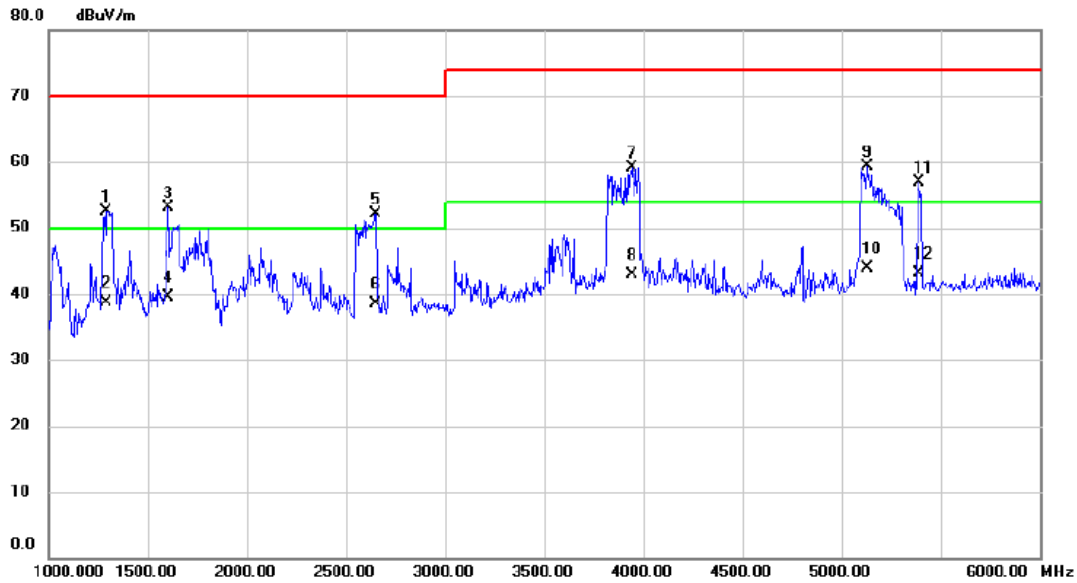

No. Mk.	Freq. MHz	Reading Level dBuV	Correct Factor dB	Measurement dBuV/m	Limit dBuV/m	Margin dB	Detector	Comment
1	1290.000	57.94	-5.40	52.54	70.00	-17.46	peak	
2	1290.000	44.09	-5.40	38.69	50.00	-11.31	AVG	
3	1600.000	57.59	-4.43	53.16	70.00	-16.84	peak	
4	1600.000	43.93	-4.43	39.50	50.00	-10.50	AVG	
5	2652.500	53.28	-1.08	52.20	70.00	-17.80	peak	
6	2652.500	39.58	-1.08	38.50	50.00	-11.50	AVG	
7	3942.500	56.63	2.49	59.12	74.00	-14.88	peak	
8	3942.500	40.40	2.49	42.89	54.00	-11.11	AVG	
9	5127.500	55.98	3.32	59.30	74.00	-14.70	peak	
10 *	5127.500	40.58	3.32	43.90	54.00	-10.10	AVG	
11	5387.500	53.18	3.73	56.91	74.00	-17.09	peak	
12	5387.500	39.37	3.73	43.10	54.00	-10.90	AVG	

Test Voltage	AC 230V/50Hz	Polarization	Vertical
Test Mode	Mode 5		

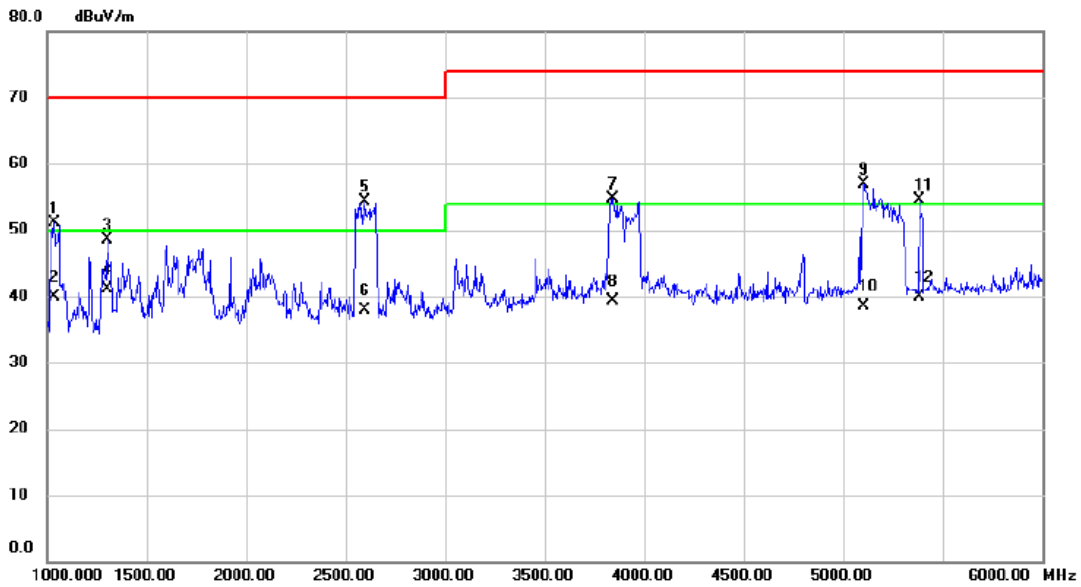

No.	Mk.	Freq. MHz	Reading Level dBuV	Correct Factor dB	Measure- ment dBuV/m	Limit dBuV/m	Margin dB	Detector	Comment
1		1037.500	57.20	-6.08	51.12	70.00	-18.88	peak	
2		1037.500	45.89	-6.08	39.81	50.00	-10.19	AVG	
3		1302.500	53.83	-5.36	48.47	70.00	-21.53	peak	
4	*	1302.500	46.46	-5.36	41.10	50.00	-8.90	AVG	
5		2595.000	55.51	-1.29	54.22	70.00	-15.78	peak	
6		2595.000	39.18	-1.29	37.89	50.00	-12.11	AVG	
7		3840.000	52.49	2.22	54.71	74.00	-19.29	peak	
8		3840.000	37.05	2.22	39.27	54.00	-14.73	AVG	
9		5102.500	53.57	3.29	56.86	74.00	-17.14	peak	
10		5102.500	35.21	3.29	38.50	54.00	-15.50	AVG	
11		5382.500	50.82	3.72	54.54	74.00	-19.46	peak	
12		5382.500	36.15	3.72	39.87	54.00	-14.13	AVG	

Test Voltage	AC 230V/50Hz	Polarization	Horizontal
Test Mode	Mode 5		

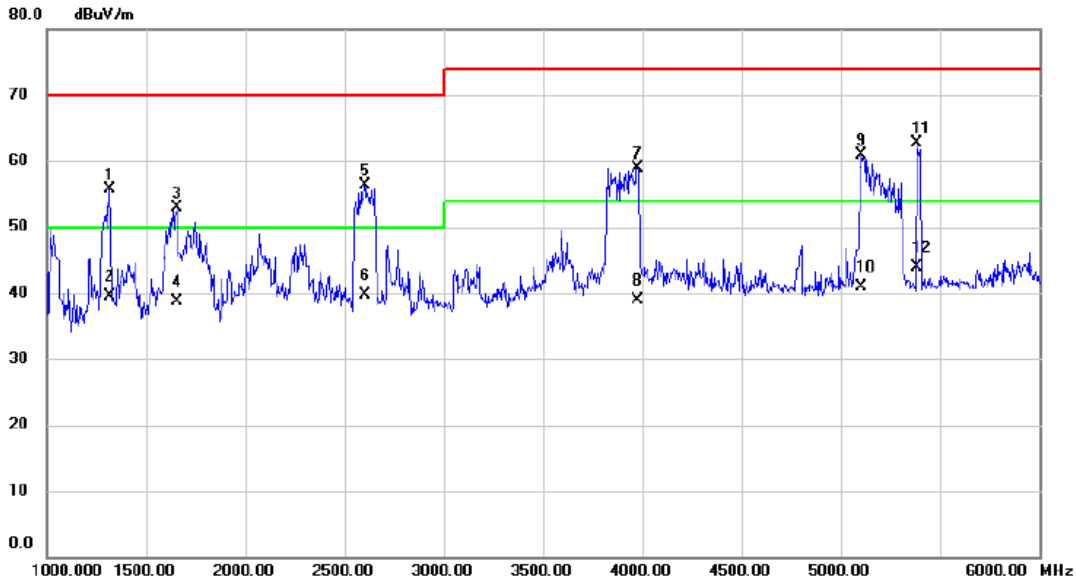

No. Mk.	Freq. MHz	Reading Level dBuV	Correct Factor dB	Measurement dBuV/m	Limit dBuV/m	Margin dB	Detector	Comment
1	1317.500	61.03	-5.32	55.71	70.00	-14.29	peak	
2	1317.500	44.91	-5.32	39.59	50.00	-10.41	AVG	
3	1657.500	57.07	-4.19	52.88	70.00	-17.12	peak	
4	1657.500	42.88	-4.19	38.69	50.00	-11.31	AVG	
5	2602.500	57.49	-1.26	56.23	70.00	-13.77	peak	
6	2602.500	40.98	-1.26	39.72	50.00	-10.28	AVG	
7	3975.000	56.30	2.58	58.88	74.00	-15.12	peak	
8	3975.000	36.41	2.58	38.99	54.00	-15.01	AVG	
9	5102.500	57.69	3.29	60.98	74.00	-13.02	peak	
10	5102.500	37.69	3.29	40.98	54.00	-13.02	AVG	
11	5382.500	58.89	3.72	62.61	74.00	-11.39	peak	
12 *	5382.500	40.26	3.72	43.98	54.00	-10.02	AVG	

Test Voltage	AC 230V/50Hz	Polarization	Vertical
Test Mode	Mode 15		

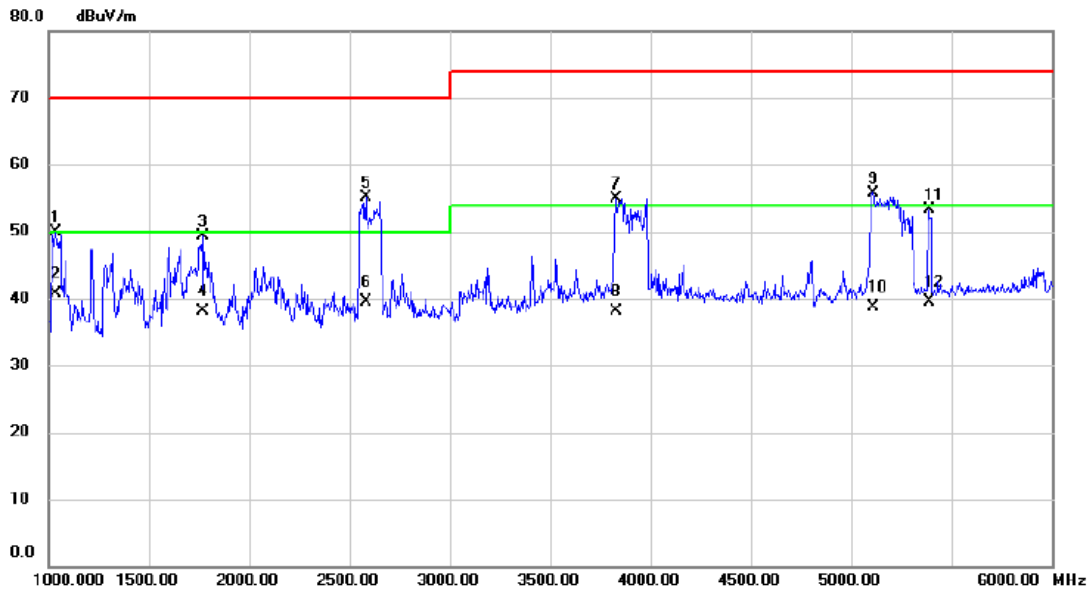

No.	Mk.	Freq. MHz	Reading Level dBuV	Correct Factor dB	Measure- ment dBuV/m	Limit dBuV/m	Margin dB	Detector	Comment
1		1037.500	55.93	-6.08	49.85	70.00	-20.15	peak	
2	*	1037.500	46.76	-6.08	40.68	50.00	-9.32	AVG	
3		1767.500	52.98	-3.75	49.23	70.00	-20.77	peak	
4		1767.500	41.95	-3.75	38.20	50.00	-11.80	AVG	
5		2582.500	56.38	-1.33	55.05	70.00	-14.95	peak	
6		2582.500	40.93	-1.33	39.60	50.00	-10.40	AVG	
7		3827.500	52.79	2.18	54.97	74.00	-19.03	peak	
8		3827.500	35.92	2.18	38.10	54.00	-15.90	AVG	
9		5112.500	52.50	3.30	55.80	74.00	-18.20	peak	
10		5112.500	35.44	3.30	38.74	54.00	-15.26	AVG	
11		5387.500	49.55	3.73	53.28	74.00	-20.72	peak	
12		5387.500	35.87	3.73	39.60	54.00	-14.40	AVG	

Test Voltage	AC 230V/50Hz	Polarization	Horizontal
Test Mode	Mode 15		

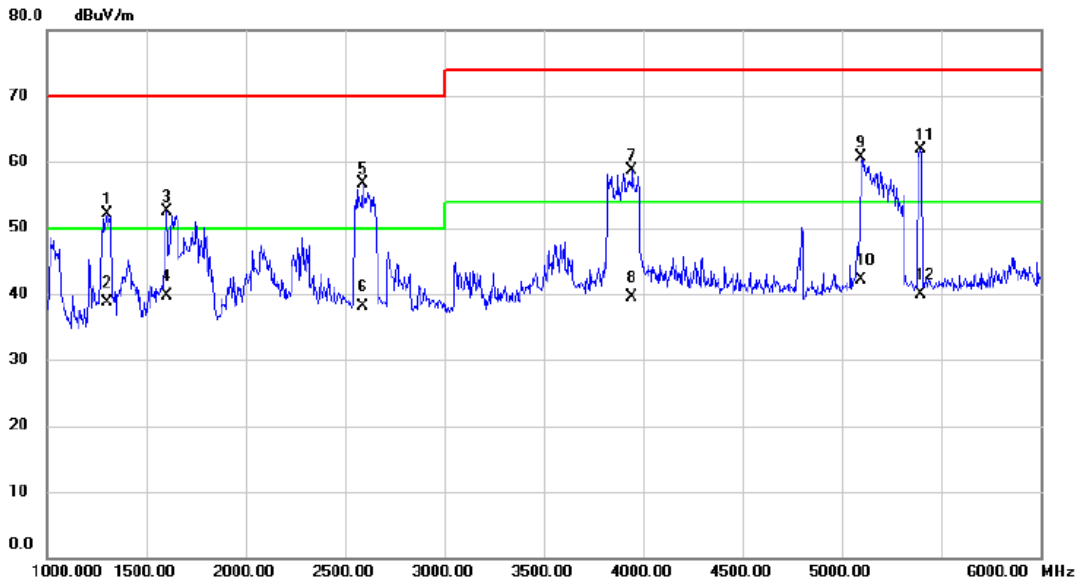

No. Mk.	Freq. MHz	Reading Level dBuV	Correct Factor dB	Measurement dBuV/m	Limit dBuV/m	Margin dB	Detector	Comment
1	1302.500	57.51	-5.36	52.15	70.00	-17.85	peak	
2	1302.500	44.03	-5.36	38.67	50.00	-11.33	AVG	
3	1600.000	56.90	-4.43	52.47	70.00	-17.53	peak	
4 *	1600.000	44.17	-4.43	39.74	50.00	-10.26	AVG	
5	2587.500	58.02	-1.31	56.71	70.00	-13.29	peak	
6	2587.500	39.40	-1.31	38.09	50.00	-11.91	AVG	
7	3945.000	56.17	2.50	58.67	74.00	-15.33	peak	
8	3945.000	37.07	2.50	39.57	54.00	-14.43	AVG	
9	5097.500	57.46	3.28	60.74	74.00	-13.26	peak	
10	5097.500	38.78	3.28	42.06	54.00	-11.94	AVG	
11	5397.500	58.22	3.74	61.96	74.00	-12.04	peak	
12	5397.500	36.13	3.74	39.87	54.00	-14.13	AVG	

Test Voltage	AC 110V/60Hz	Polarization	Vertical
Test Mode	Mode 1		

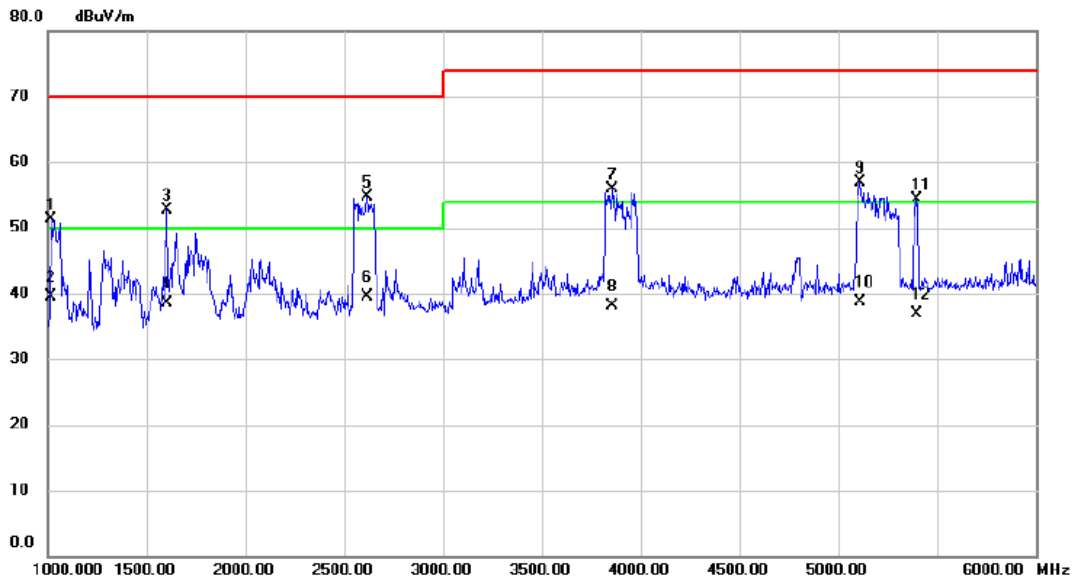

No.	Mk.	Freq. MHz	Reading Level dBuV	Correct Factor dB	Measure- ment dBuV/m	Limit dBuV/m	Margin dB	Detector	Comment
1		1017.500	57.42	-6.13	51.29	70.00	-18.71	peak	
2	*	1017.500	45.73	-6.13	39.60	50.00	-10.40	AVG	
3		1600.000	57.17	-4.43	52.74	70.00	-17.26	peak	
4		1600.000	42.89	-4.43	38.46	50.00	-11.54	AVG	
5		2615.000	55.90	-1.22	54.68	70.00	-15.32	peak	
6		2615.000	40.81	-1.22	39.59	50.00	-10.41	AVG	
7		3857.500	53.70	2.27	55.97	74.00	-18.03	peak	
8		3857.500	35.93	2.27	38.20	54.00	-15.80	AVG	
9		5110.000	53.61	3.30	56.91	74.00	-17.09	peak	
10		5110.000	35.46	3.30	38.76	54.00	-15.24	AVG	
11		5395.000	50.58	3.74	54.32	74.00	-19.68	peak	
12		5395.000	33.16	3.74	36.90	54.00	-17.10	AVG	

Test Voltage	AC 110V/60Hz	Polarization	Horizontal
Test Mode	Mode 1		

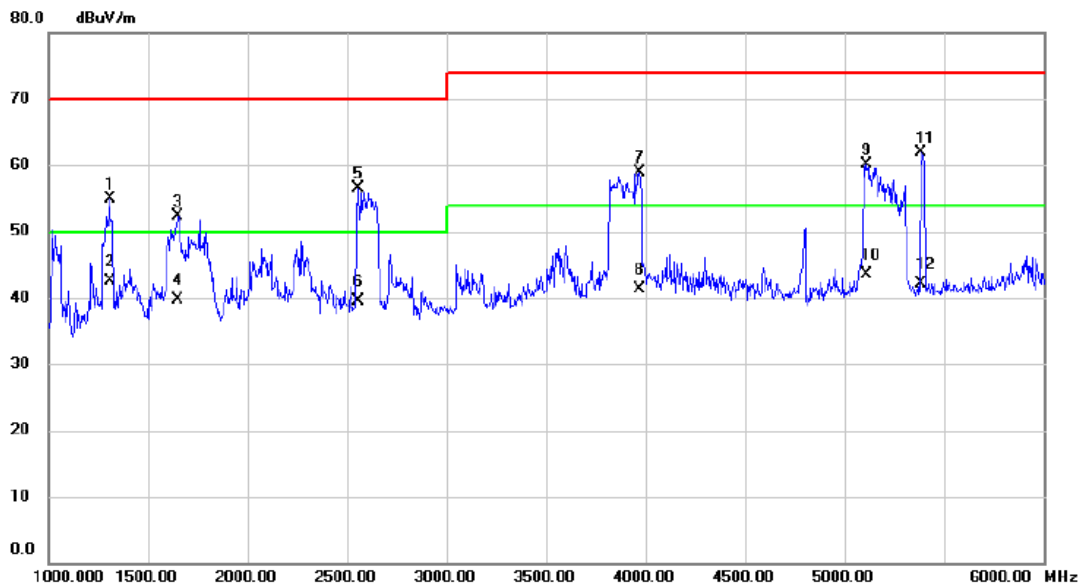

No.	Mk.	Freq. MHz	Reading Level dBuV	Correct Factor dB	Measure- ment dBuV/m	Limit dBuV/m	Margin dB	Detector	Comment
1		1307.500	60.34	-5.35	54.99	70.00	-15.01	peak	
2	*	1307.500	47.83	-5.35	42.48	50.00	-7.52	AVG	
3		1652.500	56.57	-4.22	52.35	70.00	-17.65	peak	
4		1652.500	43.88	-4.22	39.66	50.00	-10.34	AVG	
5		2557.500	57.98	-1.42	56.56	70.00	-13.44	peak	
6		2557.500	41.01	-1.42	39.59	50.00	-10.41	AVG	
7		3972.500	56.37	2.58	58.95	74.00	-15.05	peak	
8		3972.500	38.69	2.58	41.27	54.00	-12.73	AVG	
9		5110.000	56.79	3.30	60.09	74.00	-13.91	peak	
10		5110.000	40.30	3.30	43.60	54.00	-10.40	AVG	
11		5382.500	58.26	3.72	61.98	74.00	-12.02	peak	
12		5382.500	38.37	3.72	42.09	54.00	-11.91	AVG	

4.3 CONDUCTED EMISSION MEASUREMENT AT AC MAINS POWER PORTS

4.3.1 LIMITS

Requirements for conducted emissions from AC mains power ports of Class B equipment

Frequency Range MHz	Coupling Device	Detector Type / bandwidth	Class B Limits (dB(μV))
0.15 - 0.5	AMN	Quasi Peak / 9 kHz	66-56
0.5 - 5			56
5 - 30			60
0.15 - 0.5	AMN	Average / 9 kHz	56-46
0.5 - 5			46
5 - 30			50

NOTE:

(1) The test result calculated as following:

Measurement Value = Reading Level + Correct Factor

Correct Factor = Insertion Loss + Cable Loss + Attenuator Factor(if use)

Margin Level = Measurement Value – Limit Value

4.3.2 MEASUREMENT INSTRUMENTS LIST

Item	Kind of Equipment	Manufacturer	Type No.	Serial No.	Calibrated until
1	EMI TEST RECEIVER	R&S	ESCI	100382	Dec. 22, 2024
2	TWO-LINE V-NETWORK	R&S	ENV216	10274	Dec. 22, 2024
3	TWO-LINE V-NETWORK	R&S	ENV216	101447	Dec. 22, 2024
4	Measurement Software	Farad	EZ-EMC Ver.NB-03A1-01	N/A	N/A
5	Cable	N/A	SFT205-NMNM-9M -001	9M	Nov. 27, 2024

Remark: "N/A" denotes no model name, no serial no. or no calibration specified.

All calibration period of equipment list is one year.

4.3.3 TEST PROCEDURE

- a. The EUT was placed 0.8 meters from the horizontal ground plane with EUT being connected to the power mains through a line impedance stabilization network (LISN). All other support equipment powered from additional LISN(s). The LISN provide 50 Ohm/ 50uH of coupling impedance for the measuring instrument.
- b. Interconnecting cables that hang closer than 40 cm to the ground plane shall be folded back and forth in the center forming a bundle 30 to 40 cm long.
- c. I/O cables that are not connected to a peripheral shall be bundled in the center. The end of the cable may be terminated, if required, using the correct terminating impedance. The overall length shall not exceed 1 m.
- d. LISN at least 80 cm from nearest part of EUT chassis.
- e. For the actual test configuration, please refer to the related Item –EUT Test Photos.

4.3.4 DEVIATION FROM TEST STANDARD

No deviation

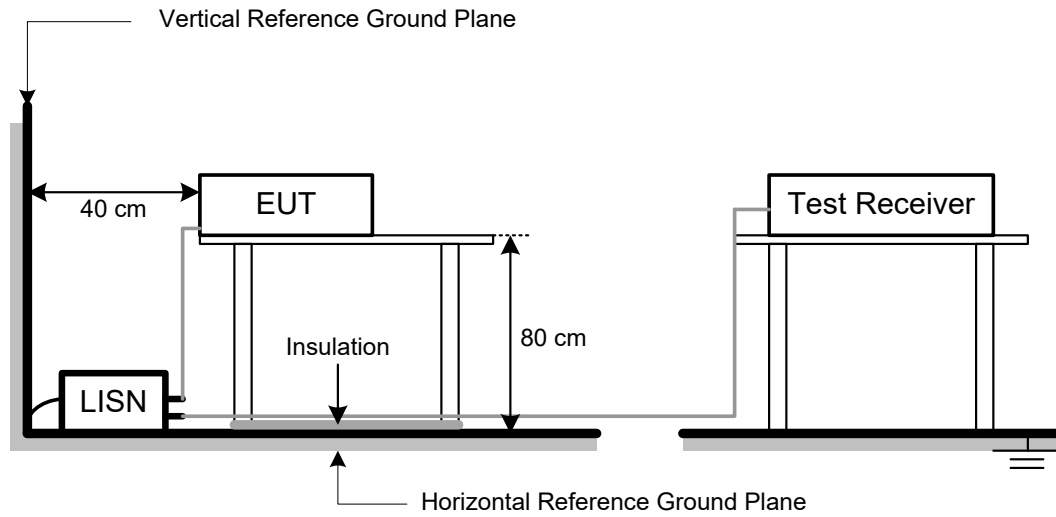
4.3.5 TEST SETUP

4.3.6 TEST RESULTS

Test Voltage	AC 230V/50Hz	Phase	Line
Test Mode	Mode 1		

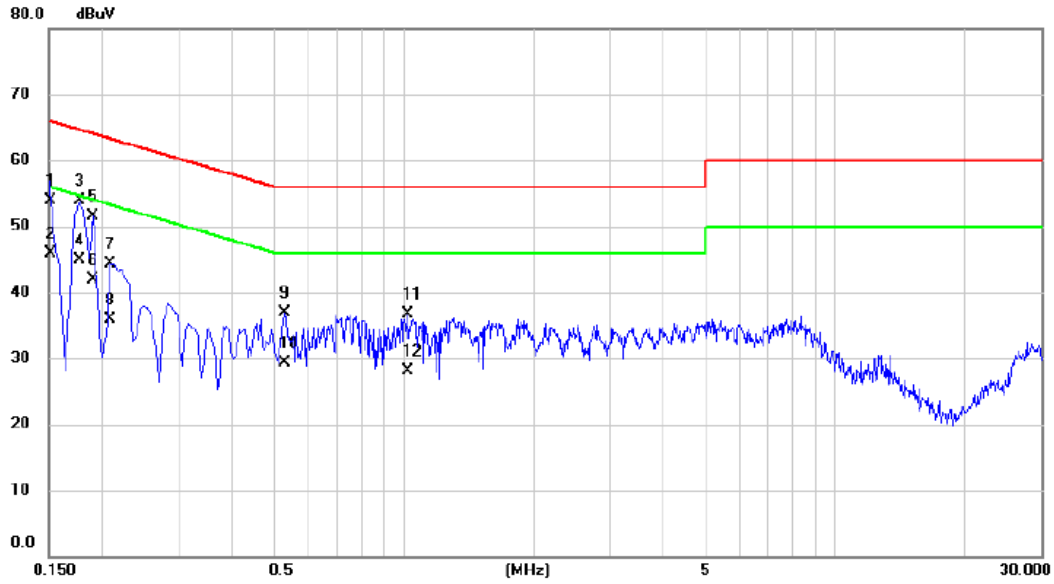

No.	Mk.	Freq. MHz	Reading Level dBuV	Correct Factor dB	Measure- ment dBuV	Limit dBuV	Margin dB	Detector	Comment
1		0.1515	44.11	9.74	53.85	65.92	-12.07	QP	
2		0.1515	36.20	9.74	45.94	55.92	-9.98	AVG	
3		0.1770	44.10	9.74	53.84	64.63	-10.79	QP	
4	*	0.1770	35.20	9.74	44.94	54.63	-9.69	AVG	
5		0.1905	41.78	9.74	51.52	64.01	-12.49	QP	
6		0.1905	32.10	9.74	41.84	54.01	-12.17	AVG	
7		0.2085	34.57	9.74	44.31	63.26	-18.95	QP	
8		0.2085	26.10	9.74	35.84	53.26	-17.42	AVG	
9		0.5280	27.06	9.79	36.85	56.00	-19.15	QP	
10		0.5280	19.50	9.79	29.29	46.00	-16.71	AVG	
11		1.0184	26.84	9.82	36.66	56.00	-19.34	QP	
12		1.0184	18.20	9.82	28.02	46.00	-17.98	AVG	

Test Voltage	AC 230V/50Hz	Phase	Neutral
Test Mode	Mode 1		

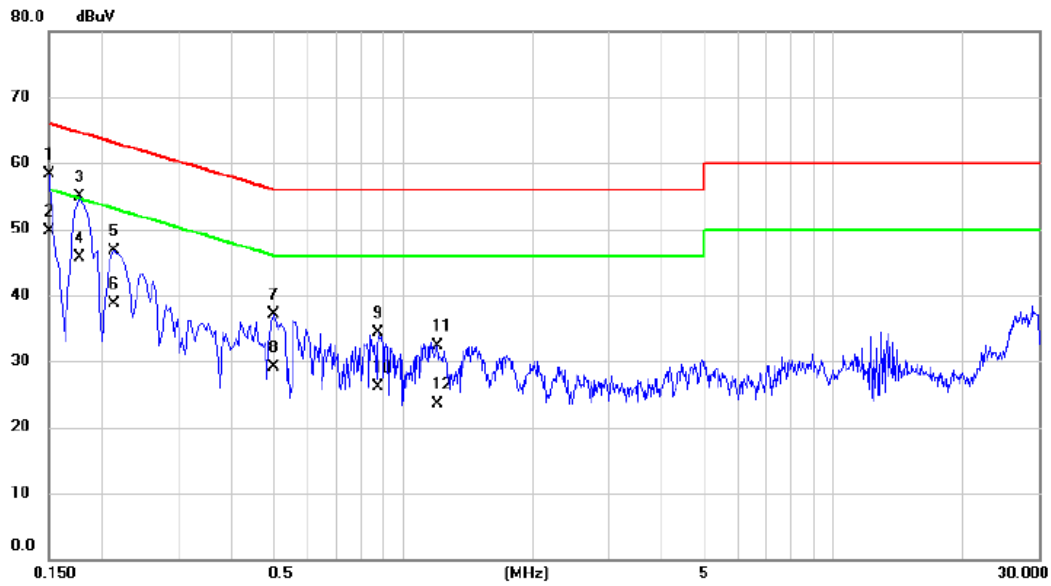

No.	Mk.	Freq. MHz	Reading Level dBuV	Correct Factor dB	Measure- ment dBuV	Limit dBuV	Margin dB	Detector	Comment
1		0.1500	48.65	9.58	58.23	66.00	-7.77	QP	
2	*	0.1500	40.20	9.58	49.78	56.00	-6.22	AVG	
3		0.1770	45.24	9.59	54.83	64.63	-9.80	QP	
4		0.1770	36.10	9.59	45.69	54.63	-8.94	AVG	
5		0.2130	37.17	9.60	46.77	63.09	-16.32	QP	
6		0.2130	29.20	9.60	38.80	53.09	-14.29	AVG	
7		0.5010	27.46	9.65	37.11	56.00	-18.89	QP	
8		0.5010	19.50	9.65	29.15	46.00	-16.85	AVG	
9		0.8744	24.56	9.67	34.23	56.00	-21.77	QP	
10		0.8744	16.40	9.67	26.07	46.00	-19.93	AVG	
11		1.1984	22.64	9.69	32.33	56.00	-23.67	QP	
12		1.1984	13.80	9.69	23.49	46.00	-22.51	AVG	

Test Voltage	AC 230V/50Hz	Phase	Line
Test Mode	Mode 4		

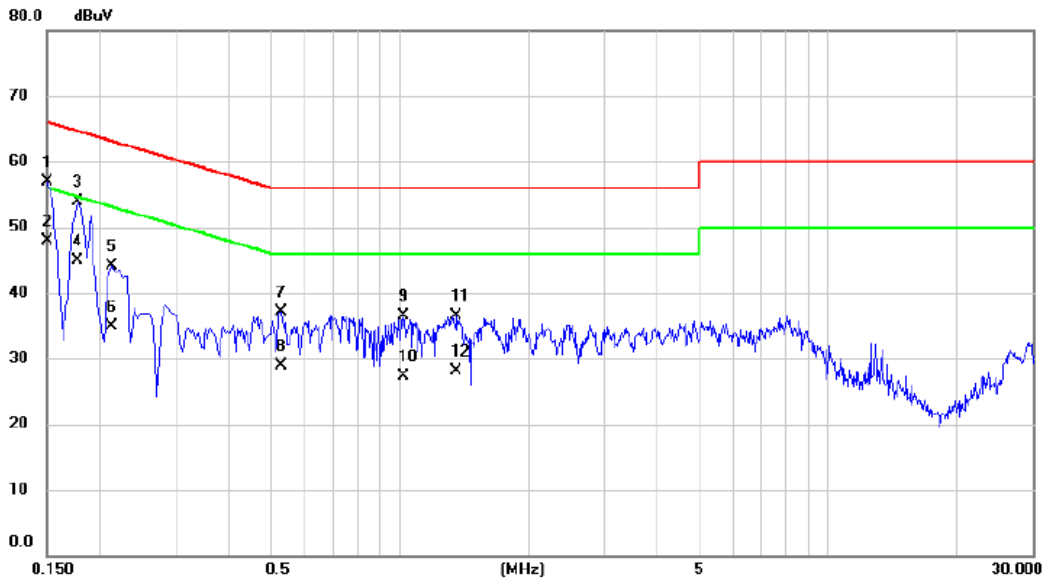

No.	Mk.	Freq. MHz	Reading Level dBuV	Correct Factor dB	Measure- ment dBuV	Limit dBuV	Margin dB	Detector	Comment
1		0.1500	47.22	9.73	56.95	66.00	-9.05	QP	
2	*	0.1500	38.20	9.73	47.93	56.00	-8.07	AVG	
3		0.1770	44.08	9.74	53.82	64.63	-10.81	QP	
4		0.1770	35.10	9.74	44.84	54.63	-9.79	AVG	
5		0.2130	34.27	9.74	44.01	63.09	-19.08	QP	
6		0.2130	25.20	9.74	34.94	53.09	-18.15	AVG	
7		0.5280	27.22	9.79	37.01	56.00	-18.99	QP	
8		0.5280	19.20	9.79	28.99	46.00	-17.01	AVG	
9		1.0184	26.67	9.82	36.49	56.00	-19.51	QP	
10		1.0184	17.50	9.82	27.32	46.00	-18.68	AVG	
11		1.3560	26.68	9.83	36.51	56.00	-19.49	QP	
12		1.3560	18.30	9.83	28.13	46.00	-17.87	AVG	

Test Voltage	AC 230V/50Hz	Phase	Neutral
Test Mode	Mode 4		

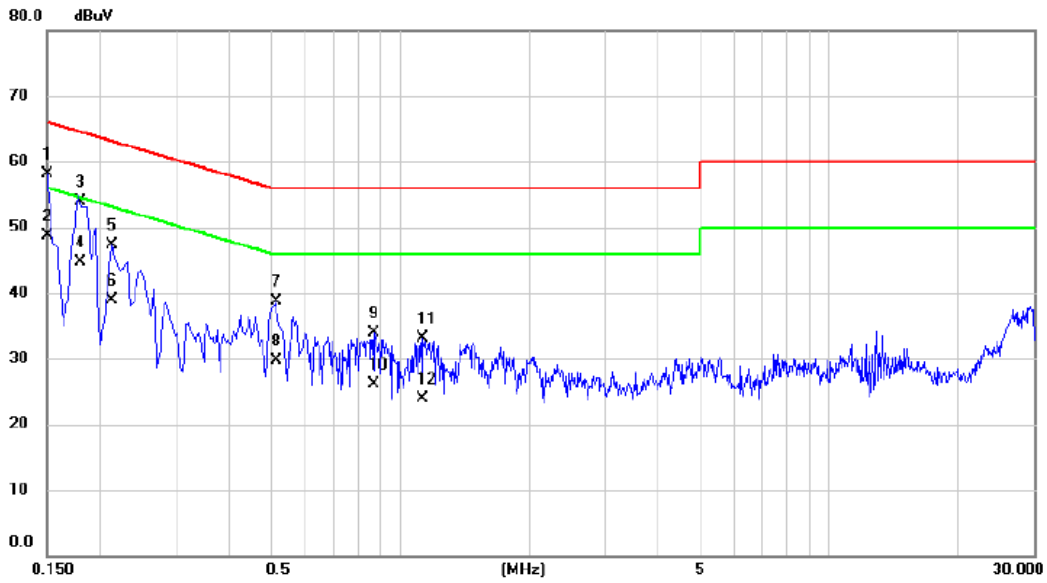

No.	Mk.	Freq. MHz	Reading Level dBuV	Correct Factor dB	Measure- ment dBuV	Limit dBuV	Margin dB	Detector	Comment
1		0.1500	48.62	9.58	58.20	66.00	-7.80	QP	
2	*	0.1500	39.20	9.58	48.78	56.00	-7.22	AVG	
3		0.1796	44.31	9.59	53.90	64.50	-10.60	QP	
4		0.1796	35.10	9.59	44.69	54.50	-9.81	AVG	
5		0.2130	37.62	9.60	47.22	63.09	-15.87	QP	
6		0.2130	29.30	9.60	38.90	53.09	-14.19	AVG	
7		0.5144	29.08	9.65	38.73	56.00	-17.27	QP	
8		0.5144	20.10	9.65	29.75	46.00	-16.25	AVG	
9		0.8700	24.24	9.67	33.91	56.00	-22.09	QP	
10		0.8700	16.50	9.67	26.17	46.00	-19.83	AVG	
11		1.1310	23.38	9.68	33.06	56.00	-22.94	QP	
12		1.1310	14.20	9.68	23.88	46.00	-22.12	AVG	

Test Voltage	AC 230V/50Hz	Phase	Line
Test Mode	Mode 5		

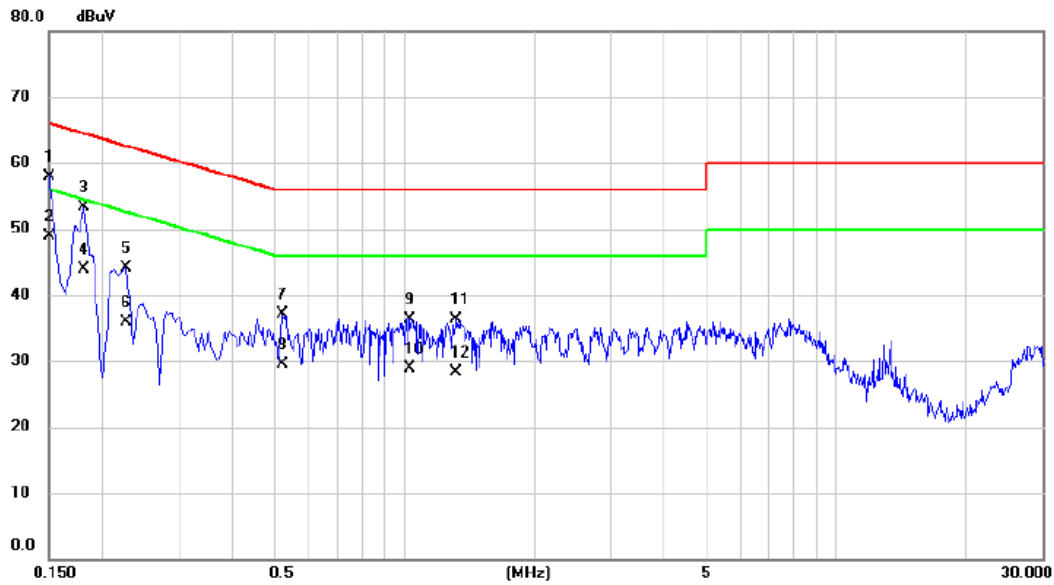

No.	Mk.	Freq. MHz	Reading Level dBuV	Correct Factor dB	Measure- ment dBuV	Limit dBuV	Margin dB	Detector	Comment
1		0.1500	48.27	9.73	58.00	66.00	-8.00	QP	
2	*	0.1500	39.20	9.73	48.93	56.00	-7.07	AVG	
3		0.1815	43.47	9.74	53.21	64.42	-11.21	QP	
4		0.1815	34.10	9.74	43.84	54.42	-10.58	AVG	
5		0.2265	34.30	9.75	44.05	62.58	-18.53	QP	
6		0.2265	26.20	9.75	35.95	52.58	-16.63	AVG	
7		0.5234	27.30	9.79	37.09	56.00	-18.91	QP	
8		0.5234	19.70	9.79	29.49	46.00	-16.51	AVG	
9		1.0274	26.52	9.82	36.34	56.00	-19.66	QP	
10		1.0274	19.10	9.82	28.92	46.00	-17.08	AVG	
11		1.3200	26.47	9.83	36.30	56.00	-19.70	QP	
12		1.3200	18.50	9.83	28.33	46.00	-17.67	AVG	

Test Voltage	AC 230V/50Hz	Phase	Neutral
Test Mode	Mode 5		

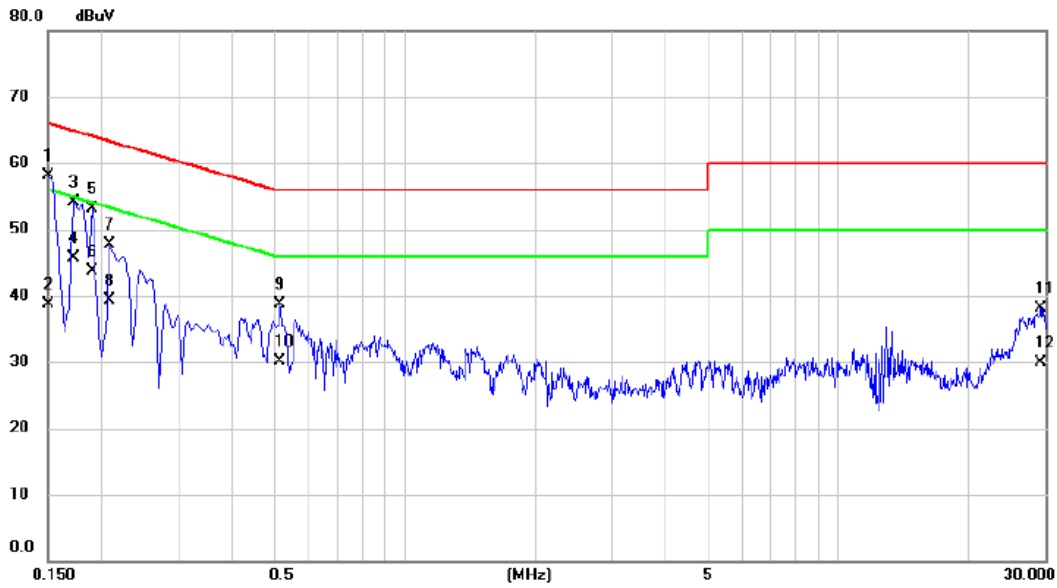

No. Mk.	Freq. MHz	Reading Level dBuV	Correct Factor dB	Measurement dBuV	Limit dBuV	Margin dB	Detector	Comment
1 *	0.1500	48.45	9.58	58.03	66.00	-7.97	QP	
2	0.1500	29.20	9.58	38.78	56.00	-17.22	AVG	
3	0.1725	44.61	9.59	54.20	64.84	-10.64	QP	
4	0.1725	36.20	9.59	45.79	54.84	-9.05	AVG	
5	0.1905	43.44	9.60	53.04	64.01	-10.97	QP	
6	0.1905	34.10	9.60	43.70	54.01	-10.31	AVG	
7	0.2085	38.02	9.60	47.62	63.26	-15.64	QP	
8	0.2085	29.80	9.60	39.40	53.26	-13.86	AVG	
9	0.5144	29.07	9.65	38.72	56.00	-17.28	QP	
10	0.5144	20.40	9.65	30.05	46.00	-15.95	AVG	
11	29.3280	27.60	10.55	38.15	60.00	-21.85	QP	
12	29.3280	19.30	10.55	29.85	50.00	-20.15	AVG	

Test Voltage	AC 110V/60Hz	Phase	Line
Test Mode	Mode 1		

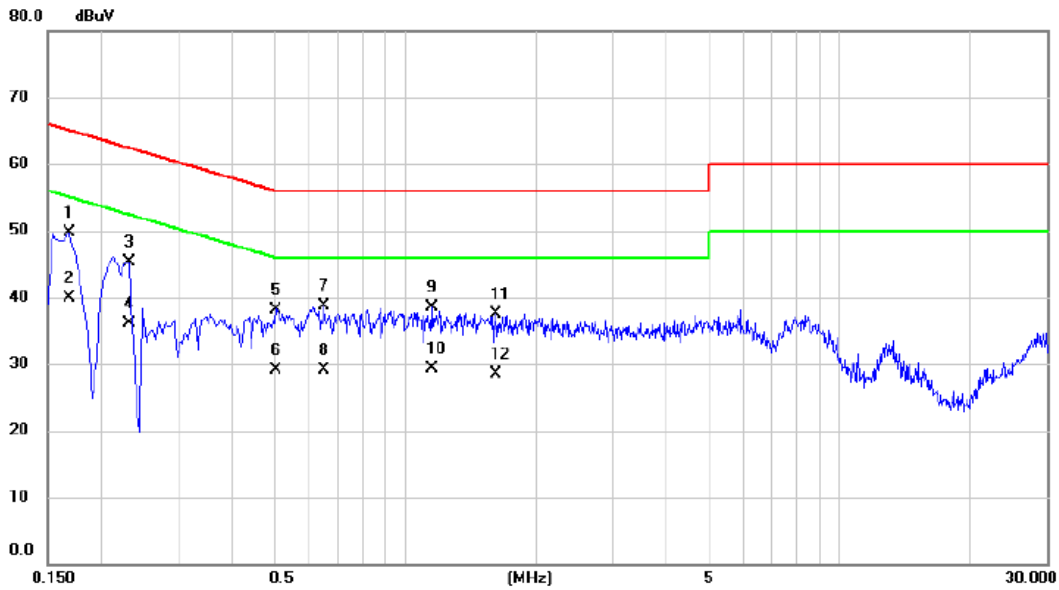

No.	Mk.	Freq. MHz	Reading Level dBuV	Correct Factor dB	Measure- ment dBuV	Limit dBuV	Margin dB	Detector	Comment
1		0.1680	39.88	9.74	49.62	65.06	-15.44	QP	
2	*	0.1680	30.20	9.74	39.94	55.06	-15.12	AVG	
3		0.2310	35.57	9.75	45.32	62.41	-17.09	QP	
4		0.2310	26.40	9.75	36.15	52.41	-16.26	AVG	
5		0.5055	28.41	9.79	38.20	56.00	-17.80	QP	
6		0.5055	19.30	9.79	29.09	46.00	-16.91	AVG	
7		0.6493	28.83	9.79	38.62	56.00	-17.38	QP	
8		0.6493	19.30	9.79	29.09	46.00	-16.91	AVG	
9		1.1534	28.60	9.82	38.42	56.00	-17.58	QP	
10		1.1534	19.50	9.82	29.32	46.00	-16.68	AVG	
11		1.6170	27.73	9.84	37.57	56.00	-18.43	QP	
12		1.6170	18.70	9.84	28.54	46.00	-17.46	AVG	

Test Voltage	AC 110V/60Hz	Phase	Neutral
Test Mode	Mode 1		

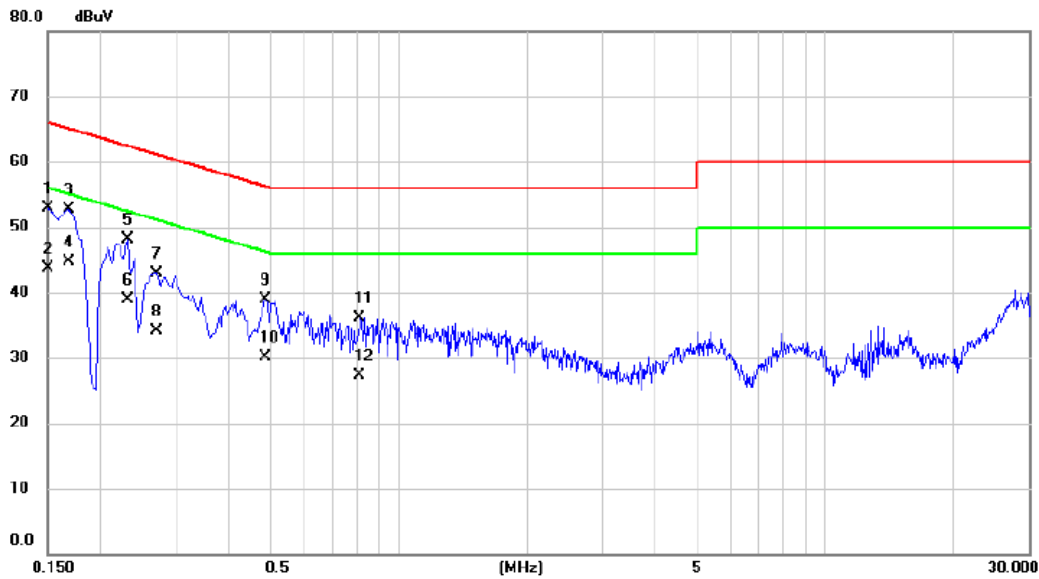

No.	Mk.	Freq. MHz	Reading Level dBuV	Correct Factor dB	Measure- ment dBuV	Limit dBuV	Margin dB	Detector	Comment
1		0.1500	43.30	9.58	52.88	66.00	-13.12	QP	
2		0.1500	34.20	9.58	43.78	56.00	-12.22	AVG	
3		0.1680	43.05	9.59	52.64	65.06	-12.42	QP	
4	*	0.1680	35.10	9.59	44.69	55.06	-10.37	AVG	
5		0.2310	38.44	9.61	48.05	62.41	-14.36	QP	
6		0.2310	29.30	9.61	38.91	52.41	-13.50	AVG	
7		0.2714	33.31	9.62	42.93	61.07	-18.14	QP	
8		0.2714	24.50	9.62	34.12	51.07	-16.95	AVG	
9		0.4875	29.19	9.65	38.84	56.21	-17.37	QP	
10		0.4875	20.50	9.65	30.15	46.21	-16.06	AVG	
11		0.8114	26.51	9.67	36.18	56.00	-19.82	QP	
12		0.8114	17.60	9.67	27.27	46.00	-18.73	AVG	

4.4 HARMONIC CURRENT EMISSIONS TEST

4.4.1 LIMITS

The power consumption is less than 75W, there is no limit applied.

4.4.2 MEASUREMENT INSTRUMENTS LIST

Item	Kind of Equipment	Manufacturer	Type No.	Serial No.	Calibrated until
1	Harmonics and Flicker Analyzer	California Instruments	PACS-1	72344	Jun. 01, 2025
2	3KVA AC Power source	California Instruments	3001ix	56309	Jun. 01, 2025
3	Measurement Software	California	CTS4.0 Version 4.29	N/A	N/A

Remark: "N/A" denotes no model name, no serial No. or no calibration specified.

All calibration period of equipment list is one year.

4.4.3 TEST PROCEDURE

- The EUT was placed on the top of a wooden table 0.8 meters above the ground and operated to produce the maximum harmonic components under normal operating conditions.
- The classification of EUT is according to of EN 61000-3-2. The EUT is classified as Class D.
- The correspondent test program of test instrument to measure the current harmonics emanated from EUT is chosen. The measure time shall be not less than the time necessary for the EUT to be exercised.

4.4.4 DEVIATION FROM TEST STANDARD

No deviation

4.4.5 TEST SETUP

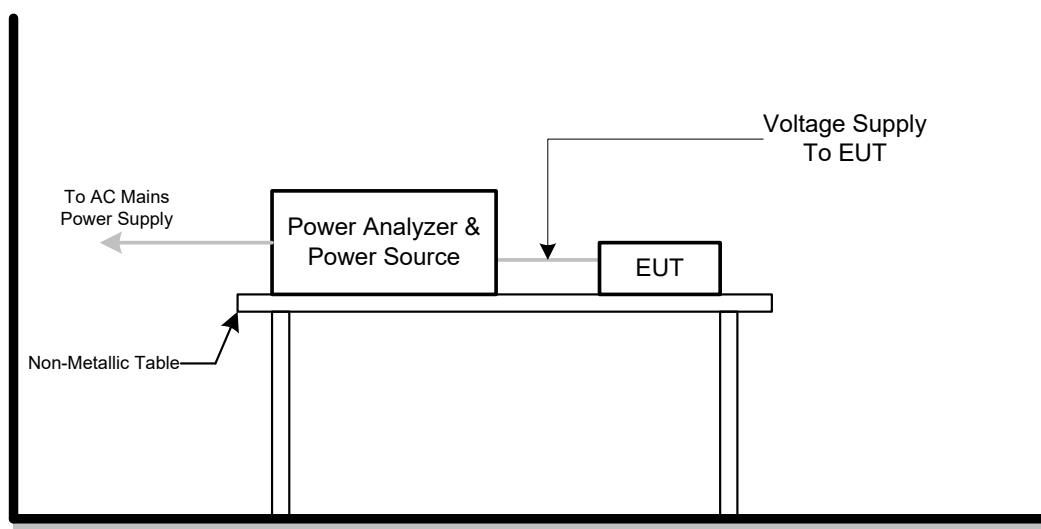

4.4.6 TEST RESULTS

Harmonics – Class-D	
Test Voltage	AC 230V/50Hz
Test Mode	Mode 1

Current & voltage waveforms

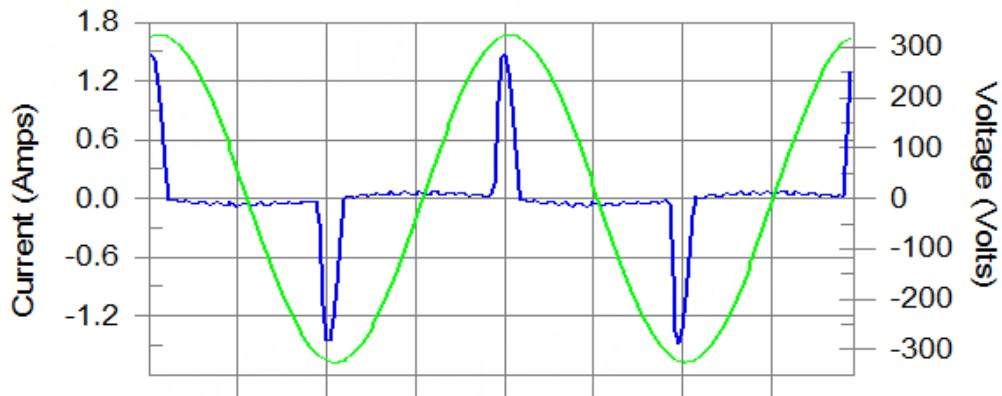

Harmonics and Class D limit line European Limits

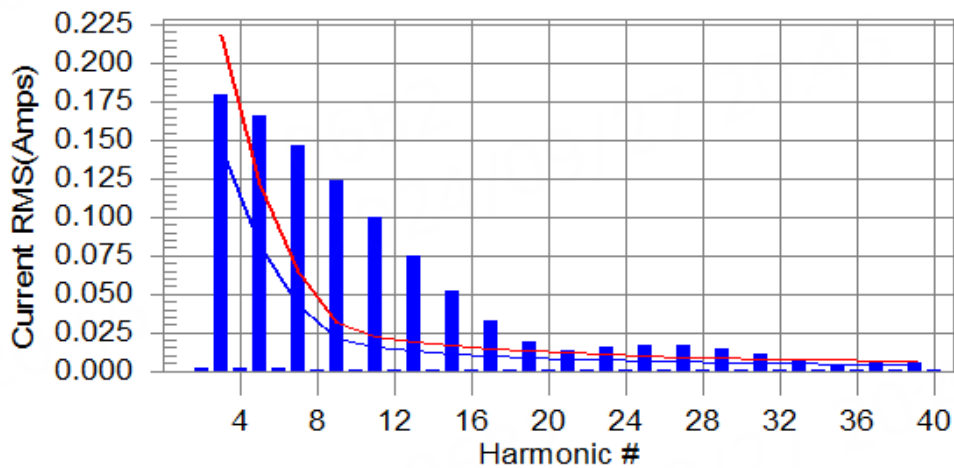

Test result: N/L Worst harmonics H0-0.0% of 150% limit, H0-0% of 100% limit

Current Test Result Summary (Run time)

Test Voltage	AC 230V/50Hz
Test Mode	Mode 1

Highest parameter values during test:

V _{RMS} (Volts):	230.02	Frequency(Hz):	50.00
I _{Peak} (Amps):	1.505	I _{RMS} (Amps):	0.397
I _{Fund} (Amps):	0.195	Crest Factor:	3.806
Power (Watts):	42.7	Power Factor:	0.473

Harm#	Harms(avg)	100%Limit	%of Limit	Harms(max)	150%Limit	%of Limit	Status
2	0.002	0.000	N/A	0.003	0.000	N/A	N/L
3	0.180	0.145	N/A	0.181	0.218	N/A	N/L
4	0.002	0.000	N/A	0.002	0.000	N/A	N/L
5	0.166	0.081	N/A	0.166	0.122	N/A	N/L
6	0.001	0.000	N/A	0.002	0.000	N/A	N/L
7	0.147	0.043	N/A	0.148	0.064	N/A	N/L
8	0.001	0.000	N/A	0.001	0.000	N/A	N/L
9	0.124	0.021	N/A	0.125	0.032	N/A	N/L
10	0.001	0.000	N/A	0.001	0.000	N/A	N/L
11	0.100	0.015	N/A	0.100	0.022	N/A	N/L
12	0.001	0.000	N/A	0.001	0.000	N/A	N/L
13	0.075	0.013	N/A	0.076	0.019	N/A	N/L
14	0.001	0.000	N/A	0.001	0.000	N/A	N/L
15	0.052	0.011	N/A	0.053	0.017	N/A	N/L
16	0.001	0.000	N/A	0.001	0.000	N/A	N/L
17	0.032	0.010	N/A	0.033	0.015	N/A	N/L
18	0.001	0.000	N/A	0.001	0.000	N/A	N/L
19	0.019	0.009	N/A	0.019	0.013	N/A	N/L
20	0.001	0.000	N/A	0.001	0.000	N/A	N/L
21	0.014	0.008	N/A	0.014	0.012	N/A	N/L
22	0.001	0.000	N/A	0.001	0.000	N/A	N/L
23	0.015	0.007	N/A	0.015	0.011	N/A	N/L
24	0.001	0.000	N/A	0.001	0.000	N/A	N/L
25	0.017	0.007	N/A	0.017	0.010	N/A	N/L
26	0.000	0.000	N/A	0.001	0.000	N/A	N/L
27	0.017	0.006	N/A	0.017	0.009	N/A	N/L
28	0.000	0.000	N/A	0.001	0.000	N/A	N/L
29	0.014	0.006	N/A	0.014	0.009	N/A	N/L
30	0.000	0.000	N/A	0.001	0.000	N/A	N/L
31	0.011	0.005	N/A	0.011	0.008	N/A	N/L
32	0.000	0.000	N/A	0.001	0.000	N/A	N/L
33	0.007	0.005	N/A	0.007	0.007	N/A	N/L
34	0.000	0.000	N/A	0.001	0.000	N/A	N/L
35	0.005	0.005	N/A	0.005	0.007	N/A	N/L
36	0.000	0.000	N/A	0.001	0.000	N/A	N/L
37	0.005	0.004	N/A	0.005	0.007	N/A	N/L
38	0.000	0.000	N/A	0.000	0.000	N/A	N/L
39	0.006	0.004	N/A	0.006	0.006	N/A	N/L
40	0.000	0.000	N/A	0.000	0.000	N/A	N/L

Voltage Source Verification Data (Run time)

Test Voltage	AC 230V/50Hz
Test Mode	Mode 1

Highest parameter values during test:

Voltage (Vrms):	230.02	Frequency(Hz):	50.00
I _{Peak} (Amps):	1.505	I _{RMS} (Amps):	0.397
I _{Fund} (Amps):	0.195	Crest Factor:	3.806
Power (Watts):	42.7	Power Factor:	0.473

Harm#	Harmonics V-rms	Limit V-rms	% of Limit	Status
2	0.109	0.460	23.73	OK
3	0.552	2.070	26.68	OK
4	0.062	0.460	13.48	OK
5	0.041	0.920	4.50	OK
6	0.035	0.460	7.60	OK
7	0.087	0.690	12.61	OK
8	0.018	0.460	3.87	OK
9	0.056	0.460	12.11	OK
10	0.022	0.460	4.85	OK
11	0.067	0.230	29.20	OK
12	0.020	0.230	8.50	OK
13	0.050	0.230	21.67	OK
14	0.019	0.230	8.24	OK
15	0.049	0.230	21.22	OK
16	0.016	0.230	7.11	OK
17	0.024	0.230	10.24	OK
18	0.014	0.230	6.19	OK
19	0.024	0.230	10.65	OK
20	0.016	0.230	7.03	OK
21	0.020	0.230	8.63	OK
22	0.012	0.230	5.23	OK
23	0.020	0.230	8.64	OK
24	0.005	0.230	2.15	OK
25	0.031	0.230	13.28	OK
26	0.009	0.230	3.89	OK
27	0.020	0.230	8.65	OK
28	0.008	0.230	3.42	OK
29	0.024	0.230	10.27	OK
30	0.007	0.230	2.95	OK
31	0.017	0.230	7.43	OK
32	0.006	0.230	2.47	OK
33	0.016	0.230	6.86	OK
34	0.003	0.230	1.50	OK
35	0.011	0.230	4.85	OK
36	0.004	0.230	1.61	OK
37	0.007	0.230	3.12	OK
38	0.003	0.230	1.18	OK
39	0.015	0.230	6.70	OK
40	0.006	0.230	2.67	OK

4.5 VOLTAGE FLUCTUATIONS (FLICKER) TEST

4.5.1 LIMITS

Tests	Limits	Descriptions
	EN 61000-3-3	
Pst	≤ 1.0 , Tp= 10 min.	Short Term Flicker Indicator
Plt	≤ 0.65 , Tp=2 hr.	Long Term Flicker Indicator
dc	$\leq 3.3\%$	Relative Steady-State V-Change
dmax	$\leq 4\%$	Maximum Relative V-change
d (t)	≤ 500 ms	Relative V-change characteristic

4.5.2 MEASUREMENT INSTRUMENTS LIST

Item	Kind of Equipment	Manufacturer	Type No.	Serial No.	Calibrated until
1	Harmonics and Flicker Analyzer	California Instruments	PACS-1	72344	Jun. 01, 2025
2	3KVA AC Power source	California Instruments	3001ix	56309	Jun. 01, 2025
3	Measurement Software	California	CTS4.0 Version 4.29	N/A	N/A

Remark: "N/A" denotes no model name, no serial No. or no calibration specified.

All calibration period of equipment list is one year.

4.5.3 TEST PROCEDURE

- a. Tests was performed according to the Test Conditions/Assessment of Voltage Fluctuations specified in EN 61000-3-3 depend on which standard adopted for compliance measurement.
- b. All types of harmonic current and/or voltage fluctuation in this report are assessed by direct measurement using flicker-meter.

4.5.4 DEVIATION FROM TEST STANDARD

No deviation

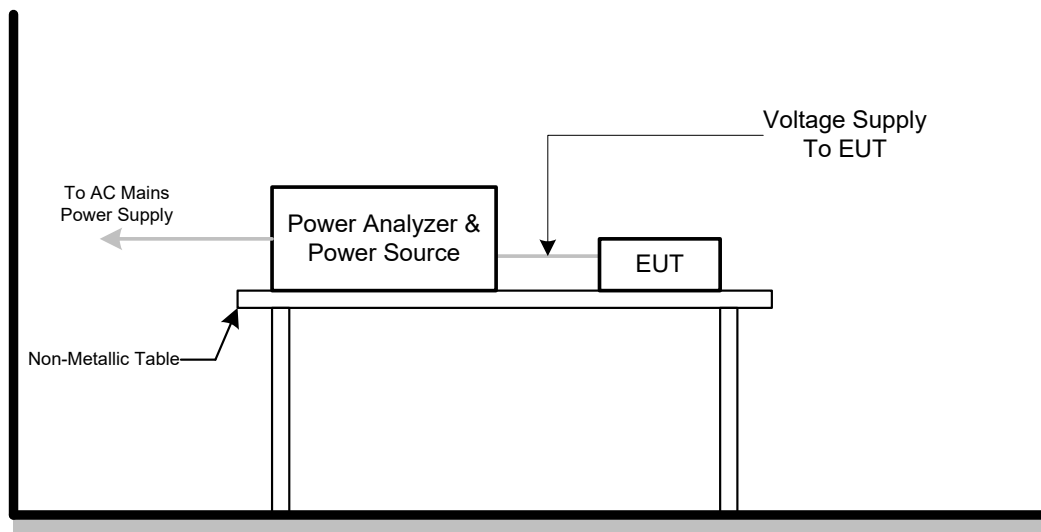
4.5.5 TEST SETUP

4.5.6 TEST RESULTS

Test Voltage	AC 230V/50Hz
Test Mode	Mode 1

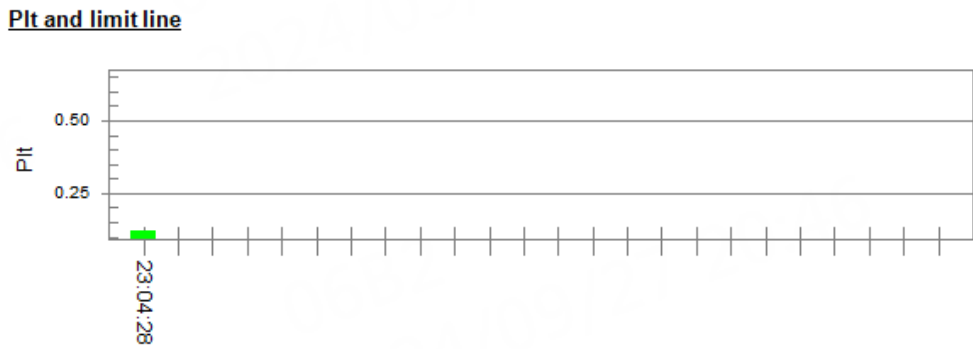
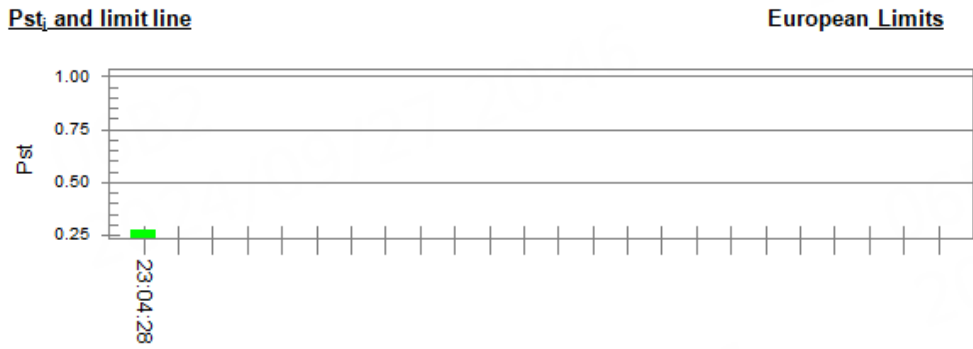

Parameter values recorded during the test:

Vrms at the end of test (Volt):	229.86		
Highest dt (%):		Test limit (%):	
T-max (mS):	0	Test limit (mS):	500.0 Pass
Highest dc (%):	0.00	Test limit (%):	3.30 Pass
Highest dmax (%):	0.00	Test limit (%):	4.00 Pass
Highest Pst (10 min. period):	0.273	Test limit:	1.000 Pass
Highest Plt (2 hr. period):	0.119	Test limit:	0.650 Pass

5. EMC IMMUNITY TEST

5.1 STANDARD COMPLIANCE/SEVERITY LEVEL/CRITERIA

Tests Standard No.	Test Specification Level / Test Mode	Test Ports	Criteria
Electrostatic discharge IEC 61000-4-2 (ESD)	±8kV air discharge ±4kV contact discharge (Direct Mode)	Enclosure	B
	±4kV HCP discharge ±4kV VCP discharge (Indirect Mode)	Enclosure	B
Continuous RF electromagnetic field disturbances,swept test IEC 61000-4-3 (RS)	80 MHz to 1000 MHz 3V/m(unmodulated, r.m.s), 1 kHz, 80%, AM modulated	Enclosure	A
Continuous RF electromagnetic field disturbances,spot test IEC 61000-4-3 (RS)	1800 MHz, 2600MHz, 3500 MHz, 5000MHz(±1 %) 3V/m(unmodulated, r.m.s), 1 kHz, 80%, AM modulated	Enclosure	A
Electrical fast transient/burst immunity IEC 61000-4-4 (EFT)	±0.5kV(peak) 5/50ns Tr/Th 5kHz Repetition Frequency (100kHz Repetition Frequency for xDSL port)	Analogue/digital data ports (NOTE 2)	B
	±0.5kV(peak) 5/50ns Tr/Th 5kHz Repetition Frequency	DC network power ports (NOTE 2)	B
	±1 kV(peak) 5/50ns Tr/Th 5kHz Repetition Frequency	AC mains power ports	B

Surge immunity IEC 61000-4-5 (Surge)	Port Type: unshielded symmetrical		
	Apply: lines to ground		
	Primary protection is Intended ±1 kV and ±4 kV 10/700(5/320)Tr/Th µs	Analogue/digital data ports (NOTE 1) & (NOTE 2)	C
	Primary protection is not Intended ±1 kV 10/700(5/320) Tr/Th µs		C
	Port type: coaxial or shielded		
	Apply: shield to ground		
±0.5 kV 1.2/50(8/20) Tr/Th µs	Analogue/digital data ports (NOTE 1) & (NOTE 2)	B	
line to reference ground for each individual line: ±0.5 kV(peak) 1.2/50(8/20) Tr/Th µs	DC network power ports (NOTE 2)	B	
±1 kV(peak) 1.2/50(8/20) Tr/Th µs (line to line) ±2 kV(peak) 1.2/50(8/20) Tr/Th µs (line to earth or ground)	AC mains power ports	B	
Continuous induced RF disturbances IEC 61000-4-6 (CS)	0.15 MHz to 10 MHz 3V(unmodulated, r.m.s), 10 MHz to 30 MHz 3V to 1V(unmodulated, r.m.s), 30 MHz to 80 MHz 1V(unmodulated, r.m.s), 1kHz 80%, AM 150Ω source impedance	Analogue/digital data ports (NOTE 2)	A
	0.15 MHz to 10 MHz 3V(unmodulated, r.m.s), 10 MHz to 30 MHz 3V to 1V(unmodulated, r.m.s), 30 MHz to 80 MHz 1V(unmodulated, r.m.s), 1kHz 80%, AM 150Ω source impedance	DC network power ports (NOTE 2)	A
	0.15 MHz to 10 MHz 3V(unmodulated, r.m.s), 10 MHz to 30 MHz 3V to 1V(unmodulated, r.m.s), 30 MHz to 80 MHz 1V(unmodulated, r.m.s), 1kHz 80%, AM 150Ω source impedance	AC mains power ports	A

Power frequency magnetic field immunity IEC 61000-4-8 (PFMF)	50 Hz or 60Hz, 1A/m(r.m.s)	Enclosure	A
Voltage dips, short interruptions and voltage variations immunity IEC 61000-4-11 (Dips)	Voltage dips: Residual voltage<5% 0.5 cycle Residual voltage<70% 25 cycle(50Hz), 30 cycle (60Hz) Voltage interruptions: Residual voltage<5% 250 cycle (50Hz), 300 cycle (60Hz)	AC Power Ports	B C C
Broadband impulse noise disturbances,repertitive (BIN-R)	0.15 MHz to 0.5 MHz 107 dBuV 0.5 MHz to 10 MHz 107 dBuV to 36 dBuV 10 MHz to 30 MHz 36 dBuV to 30 dBuV	Analogue/digital data ports (Applicable only to CPE xDSL ports)	A
	0.70 ms 8.3 ms(for 60Hz) 10 ms(for 50Hz)	Analogue/digital data ports (Apply period based on the AC mains frequency)	A
Broadband impulse noise disturbances,isolated (BIN-I)	0.15 MHz to 30 MHz 110 dBuV	Analogue/digital data ports (Applicable only to CPE xDSL ports)	B
	0.24 ms 10 ms 300 ms	Analogue/digital data ports (Apply all burst durations)	B

Note.

- 1) Applicable only to ports which, according to the manufacturer's specification, may connect directly to outdoor cables.
- 2) Applicable only to ports which, according to the manufacturer's specification, support cable lengths greater than 3 m.

5.2 GENERAL PERFORMANCE CRITERIA

According to **EN 55035** standards, the general performance criteria as following:

Criterion A	<p>The equipment shall continue to operate as intended without operator intervention. No degradation of performance, loss of function or change of operating state is allowed below a performance level specified by the manufacturer when the equipment is used as intended. The performance level may be replaced by a permissible loss of performance. If the minimum performance level or the permissible performance loss is not specified by the manufacturer, then either of these may be derived from the product description and documentation, and by what the user may reasonably expect from the equipment if used as intended.</p>
Criterion B	<p>During the application of the disturbance, degradation of performance is allowed. However, no unintended change of actual operating state or stored data is allowed to persist after the test.</p> <p>After the test, the equipment shall continue to operate as intended without operator intervention; no degradation of performance or loss of function is allowed, below a performance level specified by the manufacturer, when the equipment is used as intended. The performance level may be replaced by a permissible loss of performance. If the minimum performance level (or the permissible performance loss), or recovery time, is not specified by the manufacturer, then either of these may be derived from the product description and documentation, and by what the user may reasonably expect from the equipment if used as intended.</p>
Criterion C	<p>Loss of function is allowed, provided the function is self-recoverable, or can be restored by the operation of the controls by the user in accordance with the manufacturer's instructions. A reboot or re-start operation is allowed.</p> <p>Information stored in non-volatile memory, or protected by a battery backup, shall not be lost.</p>

5.3 ANNEX D (NORMATIVE) - DISPLAY AND DISPLAY OUTPUT FUNCTION

5.3.1 PERFORMANCE CRITERIA

Performance criterion A

for continuous radiated and conducted disturbances tests:

Apply criterion A as defined in GENERAL PERFORMANCE CRITERIA. Additionally, an increase in any degradation greater than just perceptible by observation of the image shall not occur as a consequence of the application of the test. Examples of such degradations are:

- superimposed patterning;
- positional disturbances due to synchronisation errors;
- geometric distortion;
- change of contrast or brightness;
- picture artefacts;
- freezing or disturbance of motion;
- image loss;
- video data or decoding errors.

Performance criterion A

for the power frequency magnetic field tests:

Alternative 1: A continuous magnetic field of 1 A/m:

The jitter (in mm) shall not exceed the value
$$\frac{(\text{character height in mm} + 0,3) \times 2,5}{33,3}$$

Performance criterion B:

Apply criterion B as defined in GENERAL PERFORMANCE CRITERIA.

Performance criterion C:

Apply criterion C as defined in GENERAL PERFORMANCE CRITERIA.

5.4 ANNEX G (NORMATIVE) - AUDIO OUTPUT FUNCTION

5.4.1 PERFORMANCE CRITERIA

Performance criterion A:

For devices that support telephony functions the limits of Table G.3 shall apply.

With respect to Table G.3:

- the interference ratio (electrical or acoustic) shall meet the limits in column 3; or,
- the acoustic level of the demodulated audio shall be less than the limits in column 4; or,
- the digitally coded level of demodulated audio shall be less than limits in column 5; or,
- the analogue level of the demodulated audio shall be less than the limits in column 6.

Table G.3 – Performance criterion A – Limits for devices supporting telephony

Type of immunity test	Frequency range MHz	Acoustic or electrical interference ratio	Equivalent direct measurement		
			dB (SPL)	Digital dBm0	Analogue dBm
Conducted	0,15 to 30	-20 dB	55	-50	-50
	30 to 80	-10 dB	65	-40	-40
Radiated	80 to 1000	0 dB	75	-30	-30

For terminals connected to digital wired network ports (such as Ethernet, ISDN), measurements of the demodulated 1 kHz may be performed on a remote AE, ideally of the same design.

For all other devices:

The measured acoustic interference ratio and/or the measured electrical interference ratio during the test shall be –20 dB or better.

Performance criterion B:

Use the general performance criterion B. See GENERAL PERFORMANCE CRITERIA.

Performance criterion C:

Use the general performance criterion C. See GENERAL PERFORMANCE CRITERIA.

5.5 ELECTROSTATIC DISCHARGE IMMUNITY TEST (ESD)

5.5.1 TEST SPECIFICATION

Basic Standard	IEC 61000-4-2
Discharge Impedance	330 ohm / 150 pF
Required Performance	B
Discharge Voltage	Air Discharge: $\pm 2\text{kV}$, $\pm 4\text{kV}$, $\pm 8\text{kV}$ Contact Discharge: $\pm 2\text{kV}$, $\pm 4\text{kV}$
Polarity	Positive & Negative
Number of Discharge	20 times at each test point
Discharge Mode	Single Discharge
Discharge Period	1 second

5.5.2 MEASUREMENT INSTRUMENTS

Item	Kind of Equipment	Manufacturer	Type No.	Serial No.	Calibrated until
1	ESD Generator	TESEQ AG	NSG 437	450	Nov. 12, 2024

Remark: "N/A" denotes no model name, no serial No. or no calibration specified.

All calibration period of equipment list is one year.

5.5.3 TEST PROCEDURE

The test generator necessary to perform direct and indirect application of discharges to the EUT in the following manner:

- a. The test shall be performed with single discharges. On each pre-selected point at least 10 single discharges (in the most sensitive polarity) shall be applied.

NOTE 1 The minimum number of discharges applied is depending on the EUT; for products with synchronized circuits the number of discharges should be larger.

For the time interval between successive single discharges an initial value of 1 s is recommended. Longer intervals may be necessary to determine whether a system failure has occurred.

NOTE 2 The points to which the discharges should be applied may be selected by means of an exploration carried out at a repetition rate of 20 discharges per second, or more.

Vertical Coupling Plane (VCP):

The coupling plane, of dimensions 0.5m x 0.5m, is placed parallel to, and positioned at a distance 0.1m from, the EUT, with the Discharge Electrode touching the coupling plane.

The four faces of the EUT will be performed with electrostatic discharge.

Horizontal Coupling Plane (HCP):

The coupling plane is placed under to the EUT. The generator shall be positioned vertically at a distance of 0.1m from the EUT, with the Discharge Electrode touching the coupling plane.

The four faces of the EUT will be performed with electrostatic discharge.

- b. For TABLE-TOP equipment:

The configuration consisted of a wooden table 0.8 meters high standing on the Ground Reference Plane. The GRP consisted of a sheet of aluminum at least 0.25mm thick, and 2.5 meters square connected to the protective grounding system. A Horizontal Coupling Plane (1.6m x 0.8m) was placed on the table and attached to the GRP by means of a cable with 940k total impedance. The equipment under test was installed in a representative system as described in IEC 61000-4-2, and its cables were placed on the HCP and isolated by an insulating support of 0.5mm thickness. A distance of 1-meter minimum was provided between the EUT and the walls of the laboratory and any other metallic structure.

5.5.4 DEVIATION FROM TEST STANDARD

No deviation

5.5.5 TEST SETUP

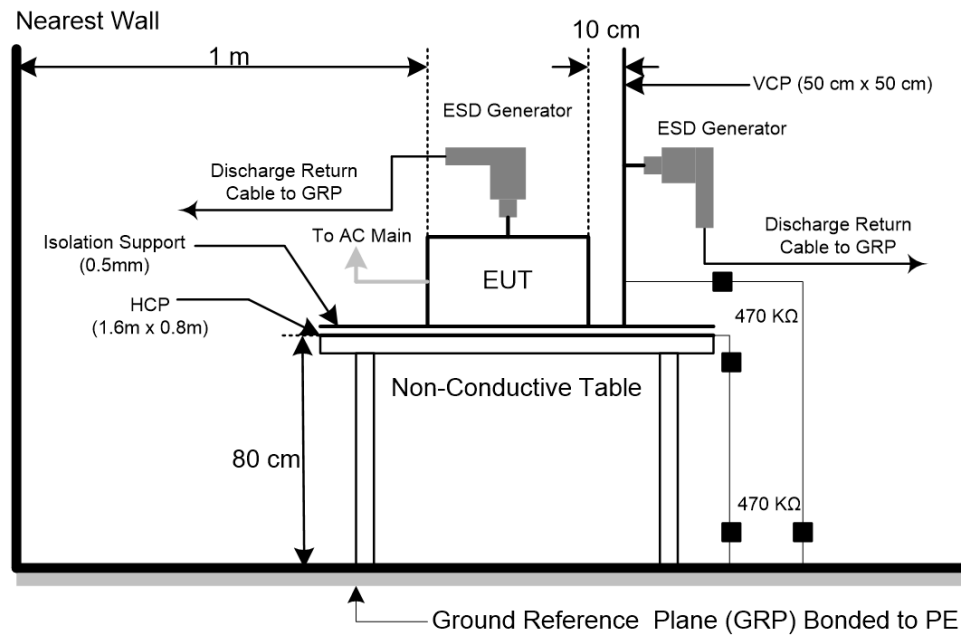

5.5.6 TEST RESULTS

Test Voltage	AC 230V/50Hz
Test Mode	Mode 1-5, Mode 8-13

Mode	Air Discharge								Contact Discharge					
	2kV		4kV		8kV		- kV		2kV		4kV		- kV	
Test Level	P	N	P	N	P	N	P	N	P	N	P	N	P	N
Location	P	N	P	N	P	N	P	N	P	N	P	N	P	N
1	A	A	A	A	B	B	-	-	A	A	B	B	-	-
2	A	A	A	A	B	B	-	-	-	-	-	-	-	-
3	A	A	A	A	B	B	-	-	-	-	-	-	-	-
4	A	A	A	A	B	B	-	-	-	-	-	-	-	-
5	A	A	A	A	B	B	-	-	-	-	-	-	-	-
Criteria	B						-		B					
Result	B						-		B					

Mode	HCP Contact Discharge						VCP Contact Discharge							
	2kV		4kV		- kV		2kV		4kV		- kV			
Test Level	P	N	P	N	P	N	P	N	P	N	P	N		
Location	P	N	P	N	P	N	P	N	P	N	P	N		
Left side	A	A	A	A	-	-	A	A	A	A	-	-		
Right side	A	A	A	A	-	-	A	A	A	A	-	-		
Front side	A	A	A	A	-	-	A	A	A	A	-	-		
Rear side	A	A	A	A	-	-	A	A	A	A	-	-		
Criteria	B						-		B					
Result	A						-		A					

Note:

- 1) P/N denotes the Positive/Negative polarity of the output voltage.
- 2) N/A - denotes test is not applicable in this test report

PHOTO(S) SHOWN THE LOCATION(S) OF ESD EVALUATED

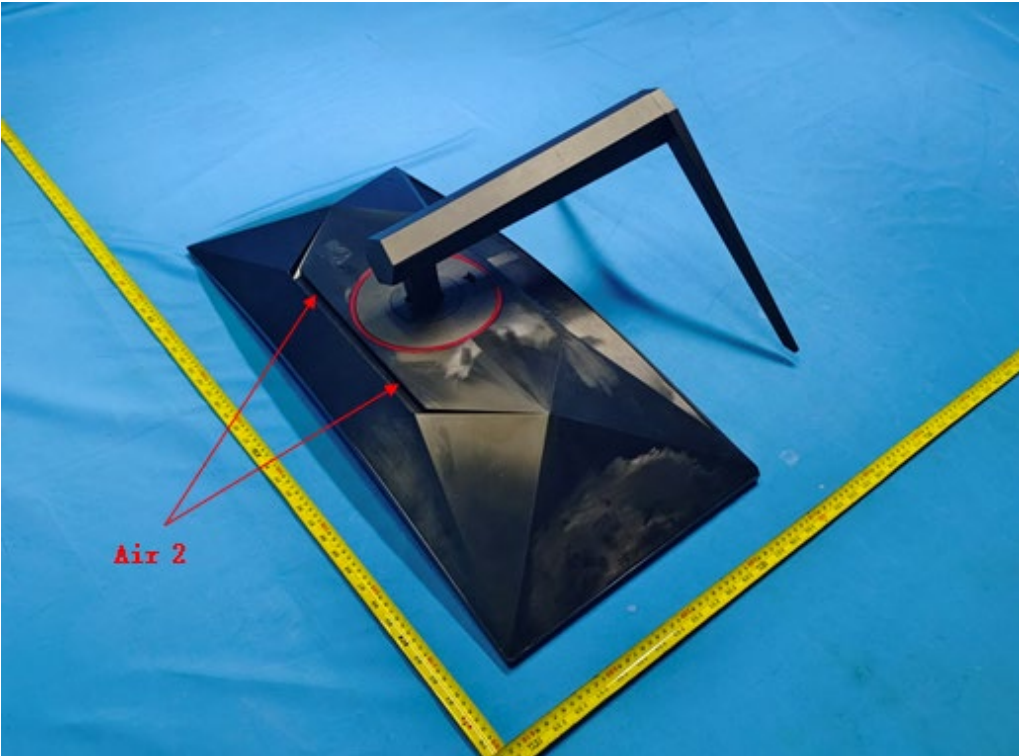
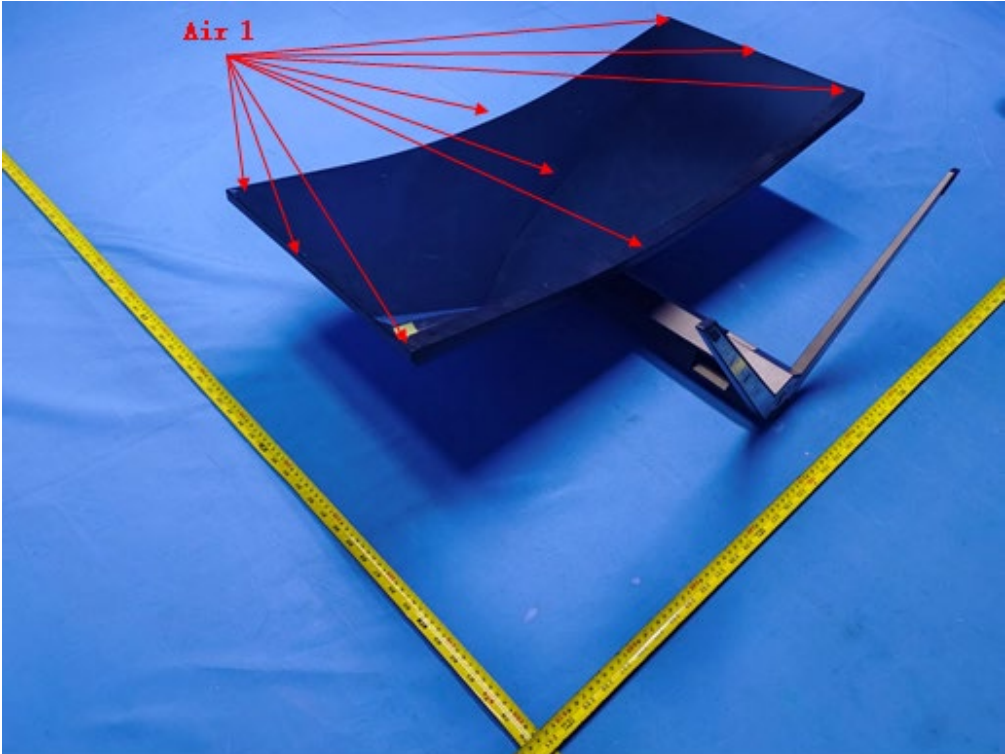

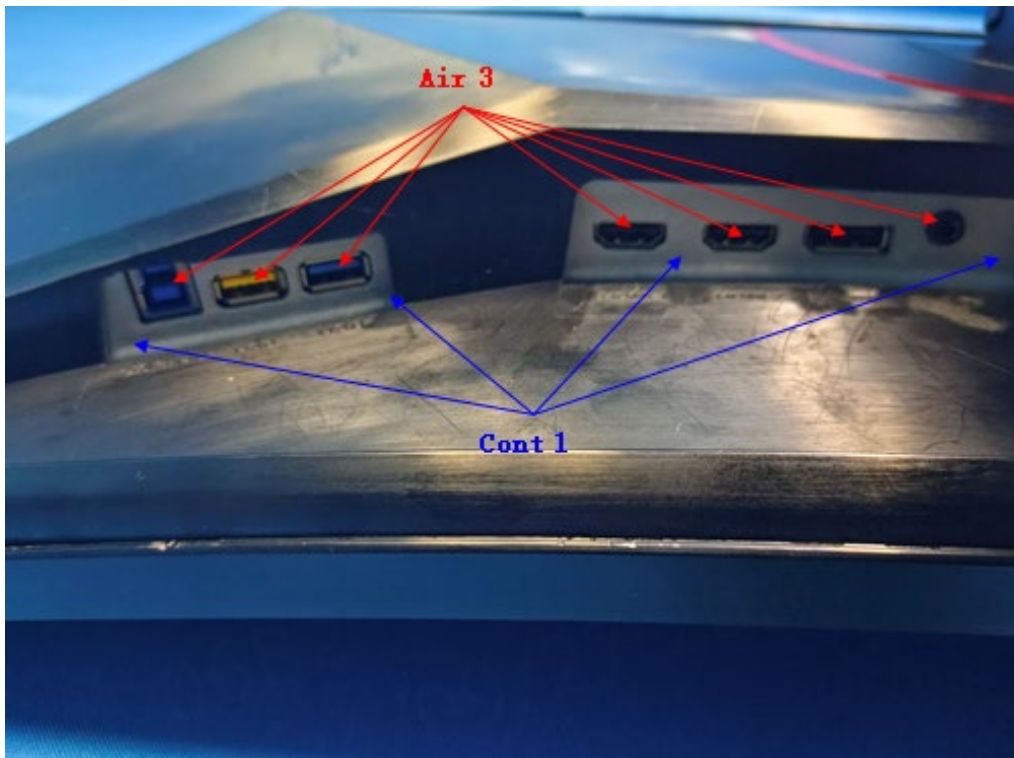

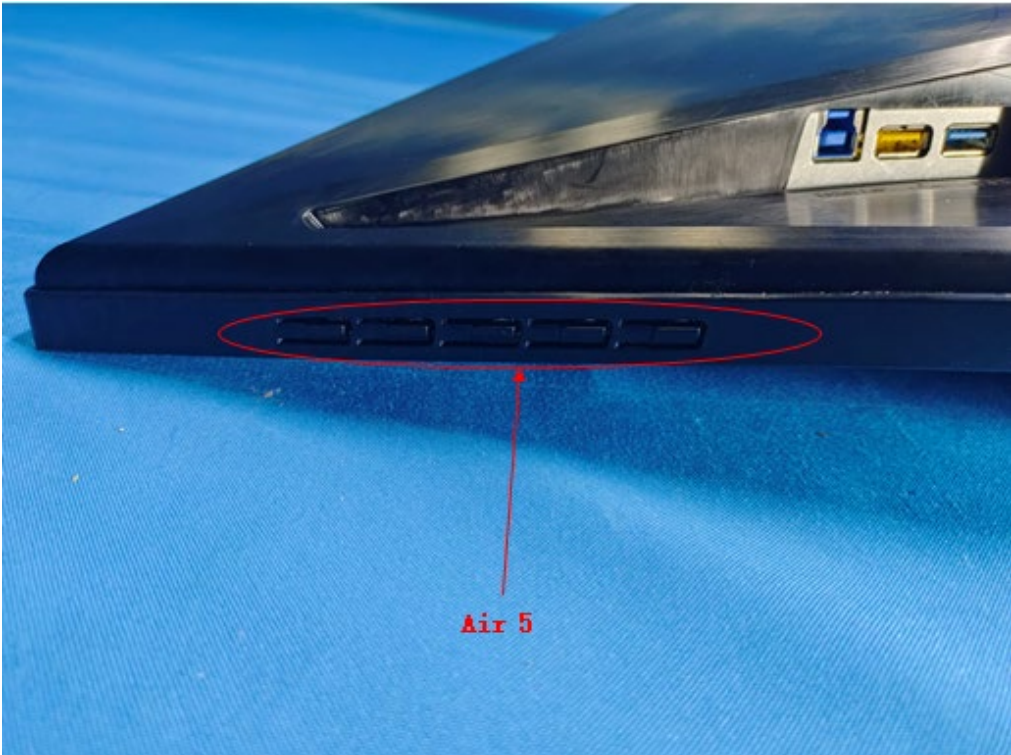

5.6 RADIATED, RADIO-FREQUENCY, ELECTROMAGNETIC FIELD IMMUNITY TEST (RS)

5.6.1 TEST SPECIFICATION

Basic Standard	IEC 61000-4-3
Required Performance	A
Frequency Range	80 MHz - 1000 MHz, 1800 MHz, 2600 MHz, 3500 MHz, 5000MHz ($\pm 1\%$)
Field Strength	3 V/m(unmodulated, r.m.s)
Modulation	1 kHz Sine Wave, 80%, AM Modulation
Frequency Step	1% of the preceding frequency.
Polarity of Antenna	Horizontal and Vertical
Test Distance	3 m
Antenna Height	1.55 m
Dwell Time	3 seconds

5.6.2 MEASUREMENT INSTRUMENTS

Item	Kind of Equipment	Manufacturer	Type No.	Serial No.	Calibrated until
1	Antenna	ETS	3142B	26419	N/A
2	Amplifier	AR	50S1G4A	326720	Dec. 22, 2024
3	MXG Analog Signal Generator	Agilent	N5181A	MY49060710	May 31, 2025
4	Power amplifier	MILMEGA	AS1860-50	1064834	Dec. 22, 2024
5	Microwave Log.-Per. Antenna	Schwarzbeck	STLP 9149	9149-277	N/A
6	Power amplifier	MILMEGA	80RF1000-250	1064833	Dec. 22, 2024
7	Measurement Software	Farad	(EZ-RS)V2.0.1.3	N/A	N/A
8	UPV Audio Analyzer	R&S	UPV	104259	Dec. 22, 2024

Remark: "N/A" denotes no model name, no serial No. or no calibration specified.

All calibration period of equipment list is one year.

5.6.3 TEST PROCEDURE

The EUT and support equipment are in a fully-anechoic chamber.

The testing distance from antenna to the EUT was 3 meters.

For TABLE-TOP equipment:

The EUT installed in a representative system as described in IEC 61000-4-3 was placed on a non-conductive table 0.8 meters in height. The system under test was connected to the power and signal wire according to relevant installation instructions.

- a. The field strength level was 3 V/m(unmodulated, r.m.s).
- b. The frequency range is swept from 80 MHz to 1000 MHz, with the signal 80%amplitude modulated with a 1 kHz sine wave. Where the frequency range is swept incrementally, the step size was 1% of the preceding frequency.
- c. The dwell time at each frequency shall be not less than the time necessary for the EUT to be able to respond.
- d. The test was performed with the EUT exposed to both vertically and horizontally polarized fields on each of the four sides.

For Display and display output functions:

- a. The display quality evaluated by direct observation.
- b. For display output function evaluation, a suitable display device shall be connected. This device shall meet the immunity requirements for displays specified in this document. The screen size shall be typical for the display output. the diagonal screen size shall be at least 0,50 m.
- c. The display shall be observed under normal viewing conditions including viewing distance using a reduced ambient light level preferably in the range 15 lx to 20 lx. The viewing distance or settings of the video camera monitoring system shall be sufficient to provide visibility of the whole display. In the case of direct observation the selected viewing distance shall be recorded in the test report.

For Acoustic measurements:

- a. Apply an appropriate input signal to the EUT so that a sine wave (tone) at the frequency that will be used to modulate the applied disturbance (typically 1 kHz) is generated from the port under test at a level equal to the acoustic reference level.
- b. Record the resulting dB (SPL) level (or other appropriate dB unit) as the value of L_0 .
(BTL lab uses the software to take L_0 as the reference value and make it return to zero.)
- c. Change the input to the EUT so that the port under test is silent, or represents silence. This change shall not alter the terminating impedance at the EUT's input.
- d. Apply the RF disturbance to the applicable port of the EUT and record the resulting demodulated audio level in dB (SPL) (or other dB unit used in step d)) as the value of L_1 .
- e. Ensure that non-linear processing does not impact the measurements.
- f. Calculate the acoustic interference ratio using the following formula:
Acoustic interference ratio = $L_1 - L_0$.
(For step e-f, BTL lab proceeds the test with software and calculate Acoustic interference ratio = $L_1 - L_0$).

5.6.4 DEVIATION FROM TEST STANDARD

No deviation

5.6.5 TEST SETUP

- a) For Continuous induced RF disturbances

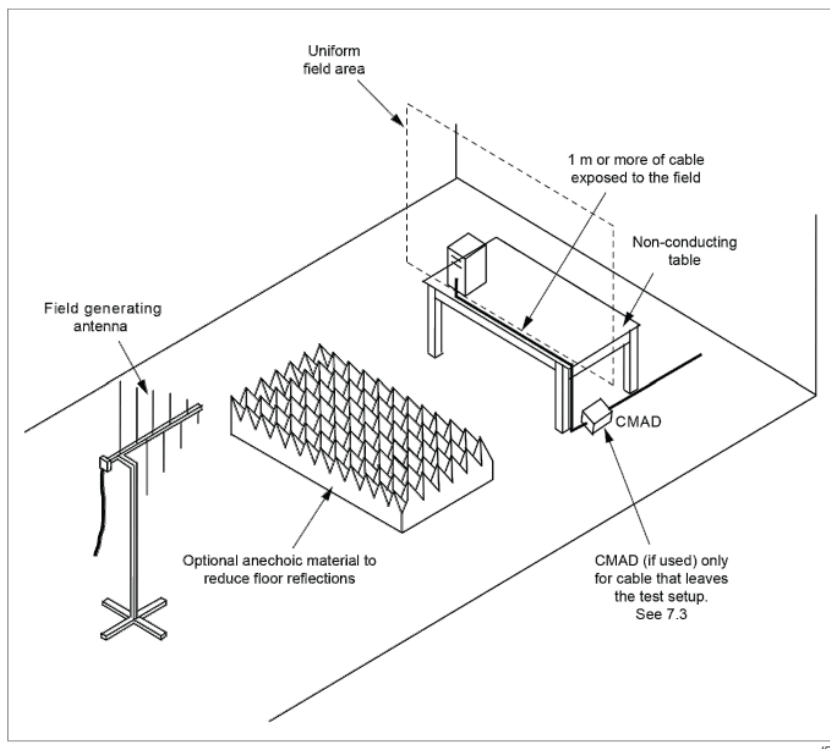

For Audio output function

(1) Audio output port

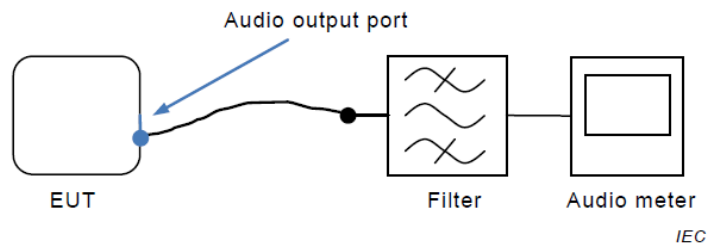

The filter is the audio filter specified in G.6.1 and is typically incorporated into the audio meter. Additional filtering might be necessary to ensure that the RF disturbance signal does not interfere with the measurement.

5.6.6 TEST RESULTS

Test Voltage	AC 230V/50Hz
Test Mode	Mode 1-5, Mode 8-13

Frequency Range (MHz)	RF Field Position	R.F. Field Strength	Modulation	Azimuth	Criterion	Result
80 - 1000	H / V	3V/m	AM Modulated 1000Hz, 80%	0	A	A
				90		
				180		
				270		
1800, 2600, 3500, 5000 (±1%)	H / V	3V/m	AM Modulated 1000Hz, 80%	0	A	A
				90		
				180		
				270		

For Audio output function

(1) For Audio output port:

Test Voltage	AC 230V/50Hz
Test Mode	Mode 1_Vertical_Front

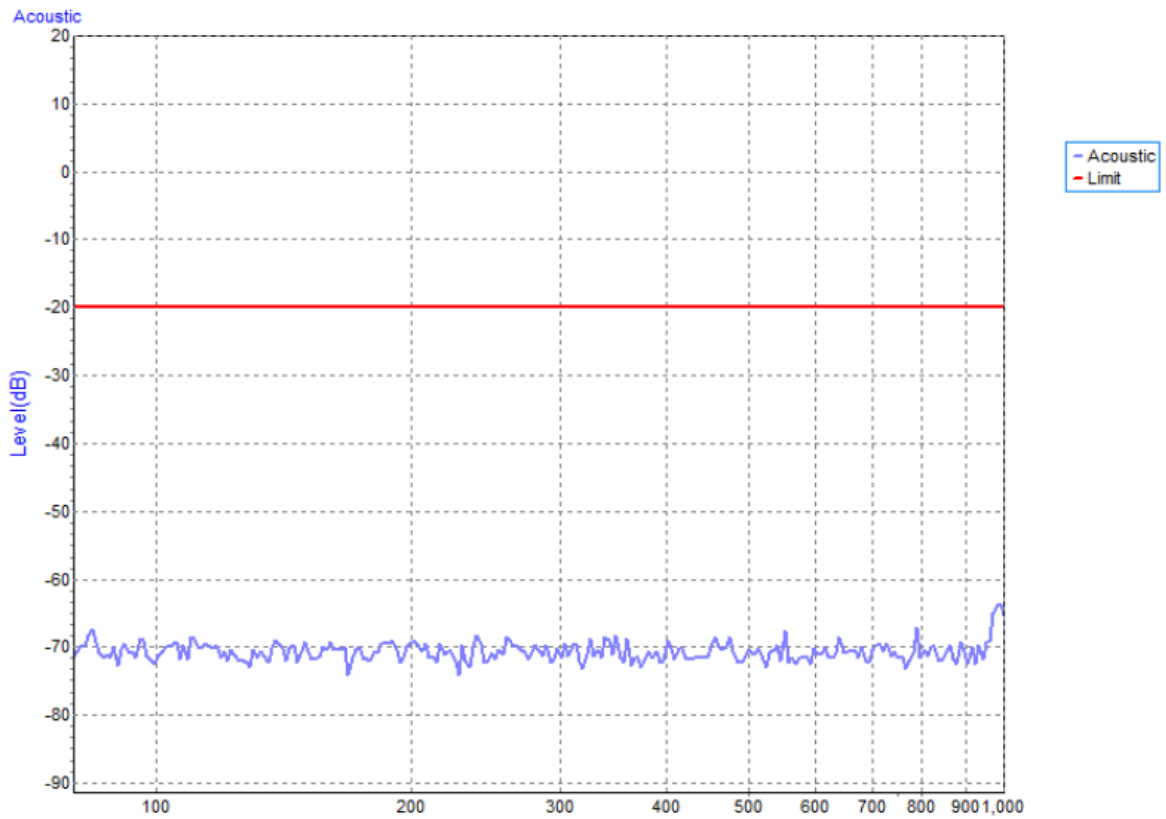

Test Voltage	AC 230V/50Hz
Test Mode	Mode 1_ Horizontal _Front

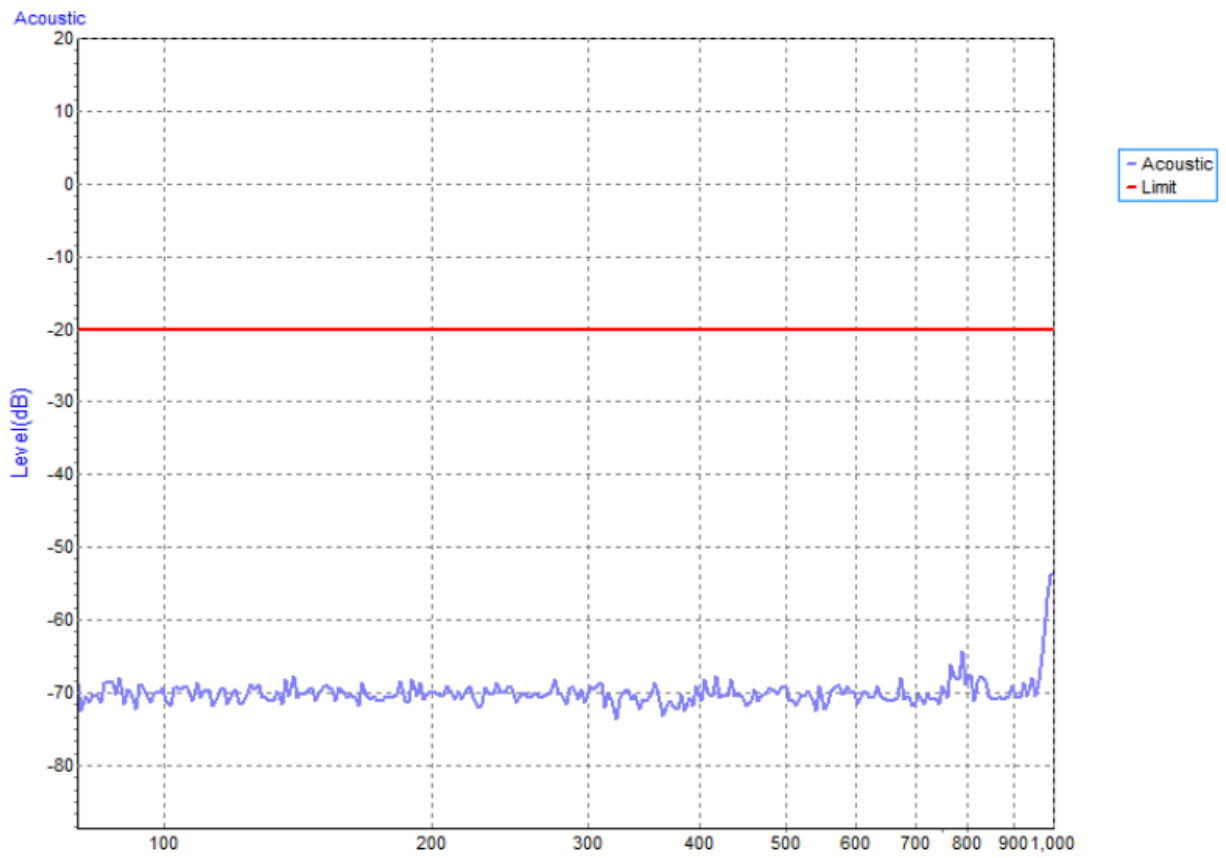

5.7 ELECTRICAL FAST TRANSIENT/BURST IMMUNITY TEST (EFT)

5.7.1 TEST SPECIFICATION

Basic Standard	IEC 61000-4-4
Required Performance	B
Test Voltage	AC mains power ports: ± 1 kV
Polarity	Positive & Negative
Impulse Frequency	5 kHz
Impulse Wave shape	5/50 ns
Burst Duration	15 ms
Burst Period	300 ms
Test Duration	1 min.

5.7.2 MEASUREMENT INSTRUMENTS

Item	Kind of Equipment	Manufacturer	Type No.	Serial No.	Calibrated until
1	Fast Transient Burst Simulator	Prima	EFT61004TA	PR190741004	May 31, 2025
2	Measurement Software	Prima	EFT_Series V1 .0.0.0.20180710	N/A	N/A

Remark: "N/A" denotes no model name, no serial No. or no calibration specified.

All calibration period of equipment list is one year.

5.7.3 TEST PROCEDURE

For TABLE-TOP equipment:

The configuration consisted of a wooden table (0.8m high) standing on the Ground Reference Plane and should be located 0.1 m \pm 0.01m above the Ground Reference Plane. The GRP consisted of a sheet of aluminum (at least 0.25mm thick and 2.5m square) connected to the protective grounding system. A minimum distance of 0.5m was provided between the EUT and the walls of the laboratory or any other metallic structure.

- a. Both positive and negative polarity discharges were applied.
- b. The duration time of each test sequential was 1 minute.

5.7.4 DEVIATION FROM TEST STANDARD

No deviation

5.7.5 TEST SETUP

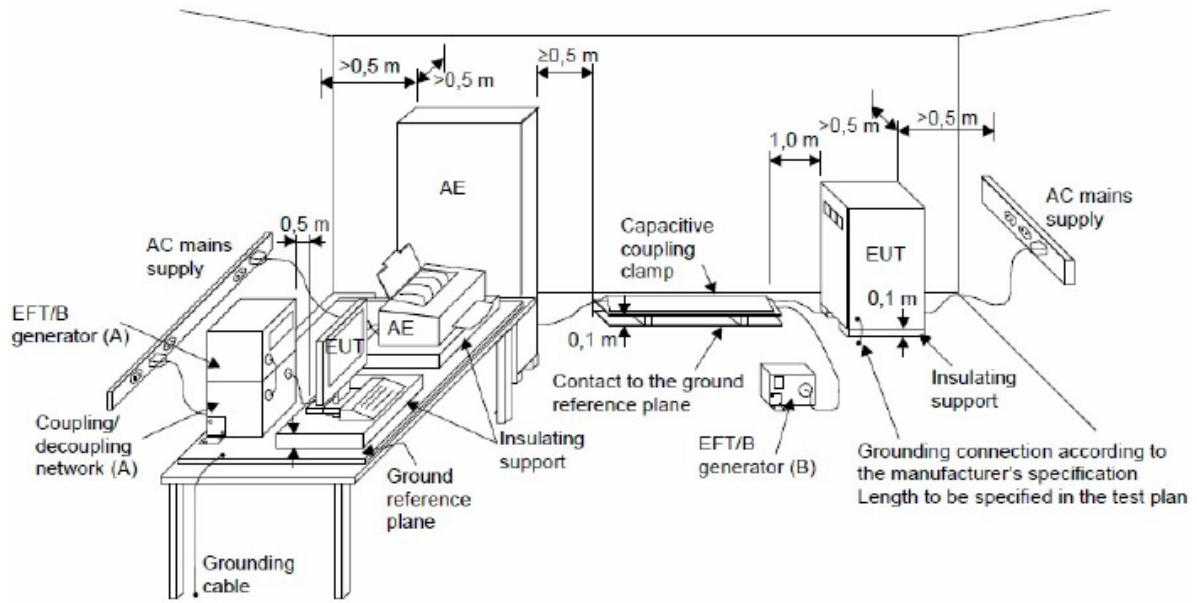

5.7.6 TEST RESULTS

Test Voltage	AC 230V/50Hz
Test Mode	Mode 1-5, Mode 8-13

EUT Ports Tested		Polarity	Repetition Frequency	Test Level	Criterion	Result
				1kV		
AC Power Port	Line (L)	+	5 kHz	B	B	B
		-	5 kHz	B		
	Neutral (N)	+	5 kHz	B	B	B
		-	5 kHz	B		
	Ground (PE)	+	5 kHz	B	B	B
		-	5 kHz	B		
	L+N	+	5 kHz	B	B	B
		-	5 kHz	B		
	L+PE	+	5 kHz	B	B	B
		-	5 kHz	B		
	N+PE	+	5 kHz	B	B	B
		-	5 kHz	B		
	L+N+PE	+	5 kHz	B	B	B
		-	5 kHz	B		

5.8 SURGE IMMUNITY TEST (SURGE)

5.8.1 TEST SPECIFICATION

Basic Standard	IEC 61000-4-5
Required Performance	B(AC mains power ports)
Wave-Shape	1.2/50(8/20) Tr/Th μ s combination wave
Test Voltage	AC mains power ports: ± 0.5 kV, ± 1 kV, ± 2 kV
Generator Source Impedance	2 Ω of the low-voltage power supply network. 12 Ω (10 Ω +2 Ω) of the low-voltage power supply network and ground.
Phase Angle, Polarity and Number of Tests	Five positive pulses line-to-neutral at 90°phase Five negative pulses line-to-neutral at 270°phase Five positive pulses line-to-earth at 90°phase Five negative pulses line-to-earth at 270°phase Five negative pulses neutral-to-earth at 90°phase Five positive pulses neutral-to-earth at 270°phase
Pulse Repetition Rate	1 time / min

5.8.2 MEASUREMENT INSTRUMENTS

Item	Kind of Equipment	Manufacturer	Type No.	Serial No.	Calibrated until
1	Lightning Surge Generator	Prima	SUG61005TB	PR190854067	May 31, 2025
2	Measurement Software	Prima	SUG_Series V1.0. 0.7.20190827	N/A	N/A

Remark: "N/A" denotes no model name, no serial No. or no calibration specified.

All calibration period of equipment list is one year.

5.8.3 TEST PROCEDURE

a. For EUT power supply:

The surge is to be applied to the EUT power supply terminals via the capacitive coupling network. Decoupling networks are required in order to avoid possible adverse effects on equipment not under test that may be powered by the same lines, and to provide sufficient decoupling impedance to the surge wave. The power cord between the EUT and the coupling/decoupling networks shall be 2meters in length (or shorter).

b. For test applied to unshielded unsymmetrically operated interconnection lines of EUT :

The surge is applied to the lines via the capacitive coupling. The coupling /decoupling networks shall not influence the specified functional conditions of the EUT. The interconnection line between the EUT and the coupling/decoupling networks shall be 2 meters in length (or shorter).

c. For test applied to unshielded symmetrically operated interconnection /telecommunication lines of EUT :

The surge is applied to the lines via gas arrestors coupling. Test levels below the ignition point of the coupling arrestor cannot be specified. The interconnection line between the EUT and the coupling/decoupling networks shall be 2 meters in length (or shorter).

5.8.4 DEVIATION FROM TEST STANDARD

No deviation

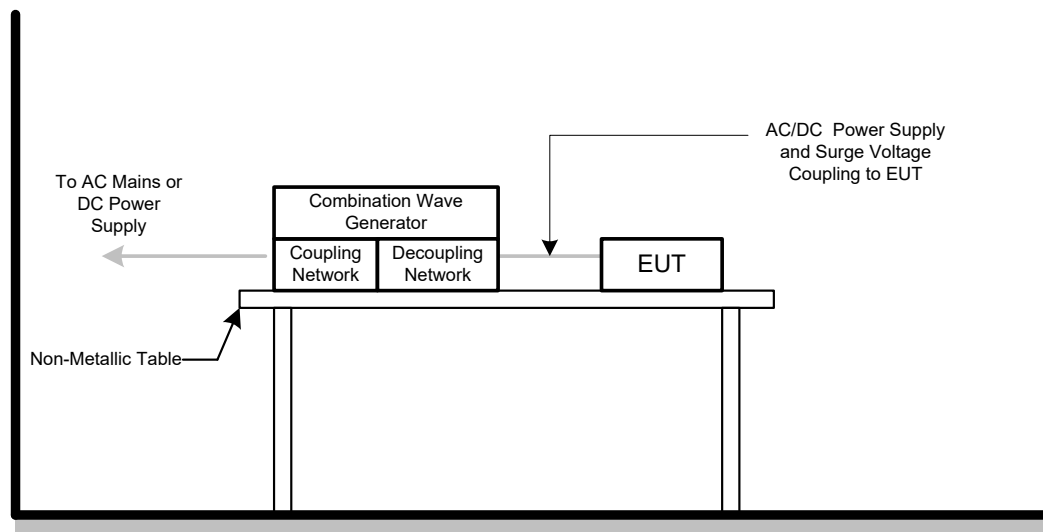
5.8.5 TEST SETUP

5.8.6 TEST RESULTS

Test Voltage	AC 230V/50Hz
Test Mode	Mode 1-5, Mode 8-13

Wave Form EUT Ports Tested		1.2/50(8/20)Tr/Thµs						Criterion	Result
		Polarity	Phase	Voltage					
				0.5kV	1kV	-- kV	-- kV		
AC	L – N	+	90°	A	B	-	-	B	B
		-	270°	A	B	-	-		

Wave Form EUT Ports Tested		1.2/50(8/20)Tr/Thµs						Criterion	Result
		Polarity	Phase	Voltage					
				0.5kV	1kV	2kV	-- kV		
AC	L – PE	+	90°	A	A	B	-	B	B
		-	270°	A	A	B	-		
	N – PE	-	90°	A	A	B	-	B	B
		+	270°	A	A	B	-		

5.9 IMMUNITY TO CONDUCTED DISTURBANCES, INDUCED BY RADIO-FREQUENCY FIELDS TEST (CS)

5.9.1 TEST SPECIFICATION

Basic Standard	IEC 61000-4-6
Required Performance	A
Frequency Range&Field Strength	0.15 MHz - 10 MHz: 3V (unmodulated, r.m.s.) 10 MHz - 30 MHz: 3V to 1V (unmodulated, r.m.s.) 30 MHz - 80 MHz: 1V (unmodulated, r.m.s.)
Modulation	1 kHz Sine Wave, 80%, AM Modulation
Frequency Step	1 % of the preceding frequency value
Dwell Time	3 seconds

5.9.2 MEASUREMENT INSTRUMENTS

Item	Kind of Equipment	Manufacturer	Type No.	Serial No.	Calibrated until
1	Test system for conducted immunity	TESEQ	NSG4070	61322	Jun. 28, 2025
2	Measurement Software	Farad	EZ-CS (Ver:B-3.1)	N/A	N/A
3	Coupling Decoupling Network	TESEQ	CDN M016	61183	Jun. 28, 2025
4	UPV Audio Analyzer	R&S	UPV	101941	Jun. 28, 2025

Remark: "N/A" denotes no model name, no serial No. or no calibration specified.

All calibration period of equipment list is one year.

5.9.3 TEST PROCEDURE

The EUT and support equipment, are placed on a table that is 0.8 meter above a metal ground plane measured 1m*1m min. and 0.65mm thick min.

The other condition as following manner:

- a. The field strength level was 3 V (unmodulated, r.m.s.)
- b. The frequency range is swept from 150 kHz to 80 MHz, with the signal 80%amplitude modulated with a 1 kHz sinewave. Where the frequency range is swept incrementally, the step size shall not exceed 1 % of the preceding frequency value.
- c. The dwell time at each frequency shall be not less than the time necessary for the EUT to be able to respond.

For Display and display output functions:

- a. The display quality evaluated by direct observation.
- b. For display output function evaluation, a suitable display device shall be connected. This device shall meet the immunity requirements for displays specified in this document. The screen size shall be typical for the display output.the diagonal screen size shall be at least 0,50 m.
- c. The display shall be observed under normal viewing conditions including viewing distance using a reduced ambient light level preferably in the range 15 lx to 20 lx. The viewing distance or settings of the video camera monitoring system shall be sufficient to provide visibility of the whole display. In the case of direct observation the selected viewing distance shall be recorded in the test report.

For Acoustic measurements:

- a. Apply an appropriate input signal to the EUT so that a sine wave (tone) at the frequency that will be used to modulate the applied disturbance (typically 1 kHz) is generated from the port under test at a level equal to the acoustic reference level.
- b. Record the resulting dB (SPL) level (or other appropriate dB unit) as the value of L_0 . (BTL lab uses the software to take L_0 as the reference value and make it return to zero.)
- c. Change the input to the EUT so that the port under test is silent, or represents silence. This change shall not alter the terminating impedance at the EUT's input.
- d. Apply the RF disturbance to the applicable port of the EUT and record the resulting demodulated audio level in dB (SPL) (or other dB unit used in step d)) as the value of L_1 .
- e. Ensure that non-linear processing does not impact the measurements.
- f. Calculate the acoustic interference ratio using the following formula:
Acoustic interference ratio = $L_1 - L_0$.
(For step e-f, BTL lab proceeds the test with software and calculate Acoustic interference ratio = $L_1 - L_0$).

5.9.4 DEVIATION FROM TEST STANDARD

No deviation

5.9.5 TEST SETUP

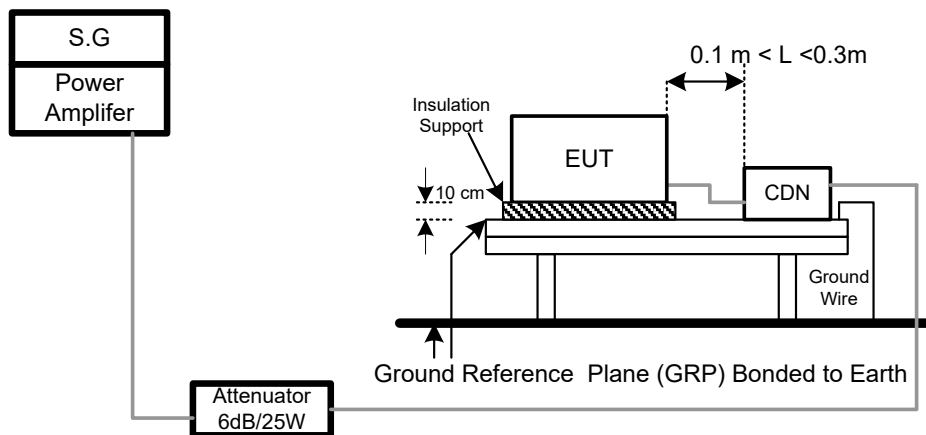

For Audio output function

(1) Audio output port

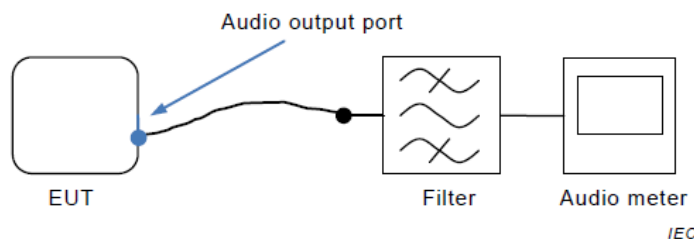

The filter is the audio filter specified in G.6.1 and is typically incorporated into the audio meter. Additional filtering might be necessary to ensure that the RF disturbance signal does not interfere with the measurement.

5.9.6 TEST RESULTS

Test Voltage	AC 230V/50Hz
Test Mode	Mode 1-5, Mode 8-13

Test Ports (Mode)	Freq.Range (MHz)	Field Strength	Modulation	Criteria	Results
AC mains power ports	0.15 - 10	3V	AM Modulated 1000Hz, 80%	A	A
	10 - 30	3V to 1V			
	30 - 80	1V			

For Audio output function

(1) For Audio output port:

Test Voltage	AC 230V/50Hz
Test Mode	Mode 1_CDN M3

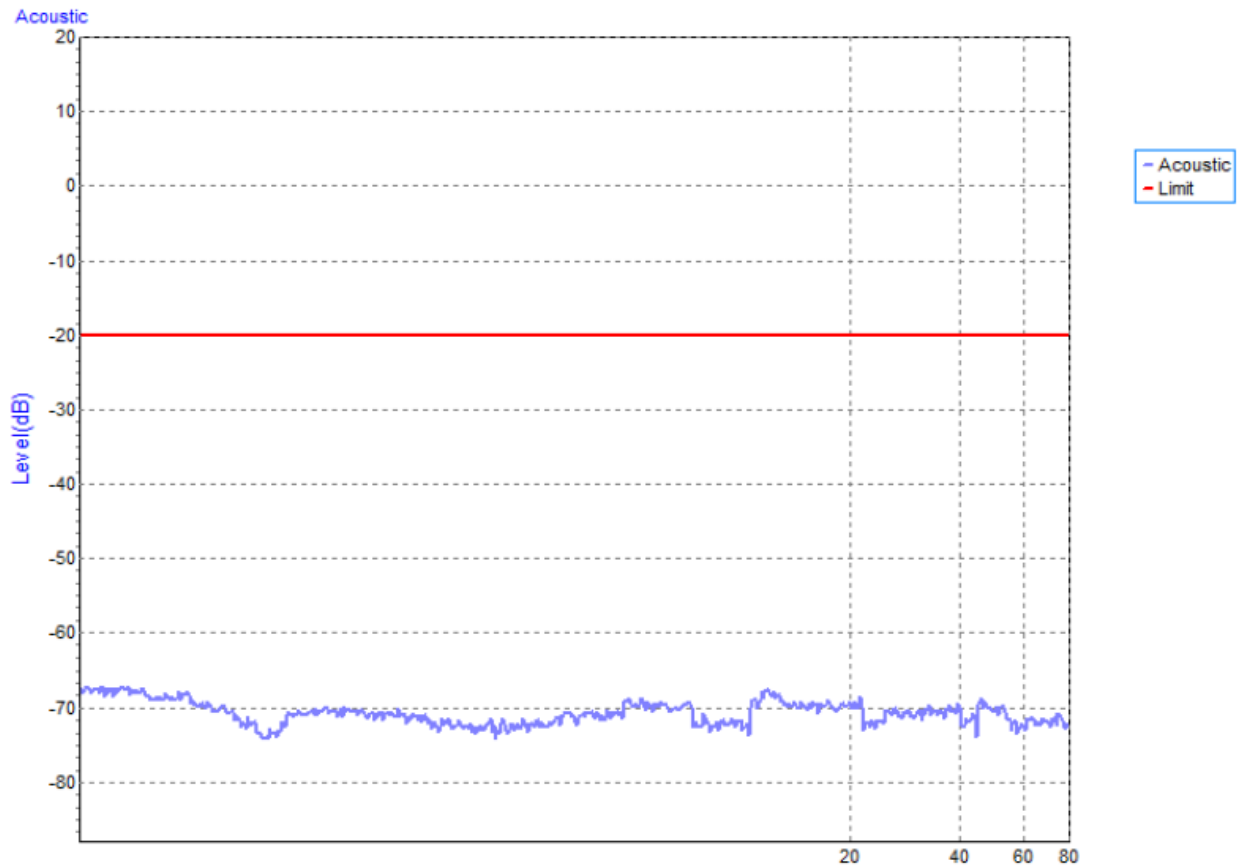

5.10 POWER FREQUENCY MAGNETIC FIELD IMMUNITY TEST (PFMF)

5.10.1 TEST SPECIFICATION

Basic Standard	IEC 61000-4-8
Required Performance	A
Frequency Range	50/60Hz
Field Strength	1 A/m
Observation Time	1 minute
Inductance Coil	Rectangular type, 1mx1m

5.10.2 MEASUREMENT INSTRUMENTS

Item	Kind of Equipment	Manufacturer	Type No.	Serial No.	Calibrated until
1	Magnetic Field test Generator	FCC	F-1000-4-8-G-125A	04032	Dec. 22, 2024
2	Magnetic Field immunity loop	Thermo KeyTek	F-1000-4-8/9/10-L-1M	04024	Dec. 22, 2024

Remark: "N/A" denotes no model name, no serial No. or no calibration specified.

All calibration period of equipment list is one year.

5.10.3 TEST PROCEDURE

For TABLE-TOP equipment:

The equipment shall be subjected to the test magnetic field by using the induction coil of standard dimension (1 m x 1 m). The induction coil shall then be rotated by 90 degrees in order to expose the EUT to the test field with different orientations.

The other condition as following manner:

- a. The equipment cabinets shall be connected to the safety earth directly on the GRP via the earth terminal of the EUT.
- b. The cables supplied or recommended by the equipment manufacturer shall be used. 1 meter of all cables used shall be exposed to the magnetic field.

5.10.4 DEVIATION FROM TEST STANDARD

No deviation

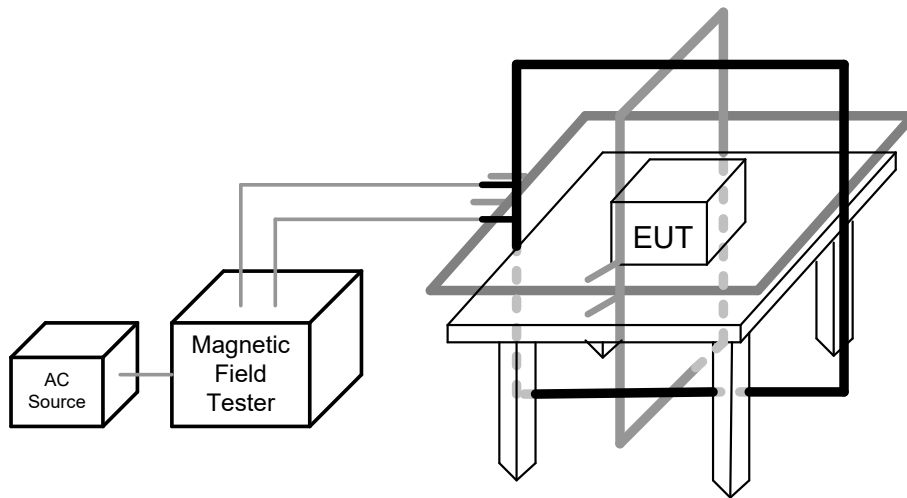
5.10.5 TEST SETUP

5.10.6 TEST RESULTS

Test Voltage	AC 230V/50Hz
Test Mode	Mode 1-5, Mode 8-13

50Hz

Test Mode	Test Level	Antenna aspect	Duration	Criteria	Results
Enclosure	1 A/m	X	60s	A	A
Enclosure	1 A/m	Y	60s	A	A
Enclosure	1 A/m	Z	60s	A	A

60Hz

Test Mode	Test Level	Antenna aspect	Duration	Criteria	Results
Enclosure	1 A/m	X	60s	A	A
Enclosure	1 A/m	Y	60s	A	A
Enclosure	1 A/m	Z	60s	A	A

5.11 VOLTAGE DIPS, SHORT INTERRUPTIONS AND VOLTAGE VARIATIONS IMMUNITY TEST (DIPS)

5.11.1 TEST SPECIFICATION

Basic Standard	IEC 61000-4-11
Required Performance	Voltage dips: B (For <5% residual voltage, dips) C (For 70% residual voltage, dips) C (For <5% residual voltage, Interruptions)
Interval between Event	Ten seconds
Phase Angle	0°/180°
Test Cycle	3 times

5.11.2 MEASUREMENT INSTRUMENTS

Item	Kind of Equipment	Manufacturer	Type No.	Serial No.	Calibrated until
1	Cycle Sag Simulator	Prima	DRP61011TA	PR19076452	May 31, 2025

Remark: "N/A" denotes no model name, no serial No. or no calibration specified.

All calibration period of equipment list is one year.

5.11.3 TEST PROCEDURE

The EUT shall be tested for each selected combination of test levels and duration with a sequence of three dips/interruptions with intervals of 10 s minimum (between each test event). Each representative mode of operation shall be tested. Abrupt changes in supply voltage shall occur at zero crossings of the voltage waveform.

5.11.4 DEVIATION FROM TEST STANDARD

No deviation

5.11.5 TEST SETUP

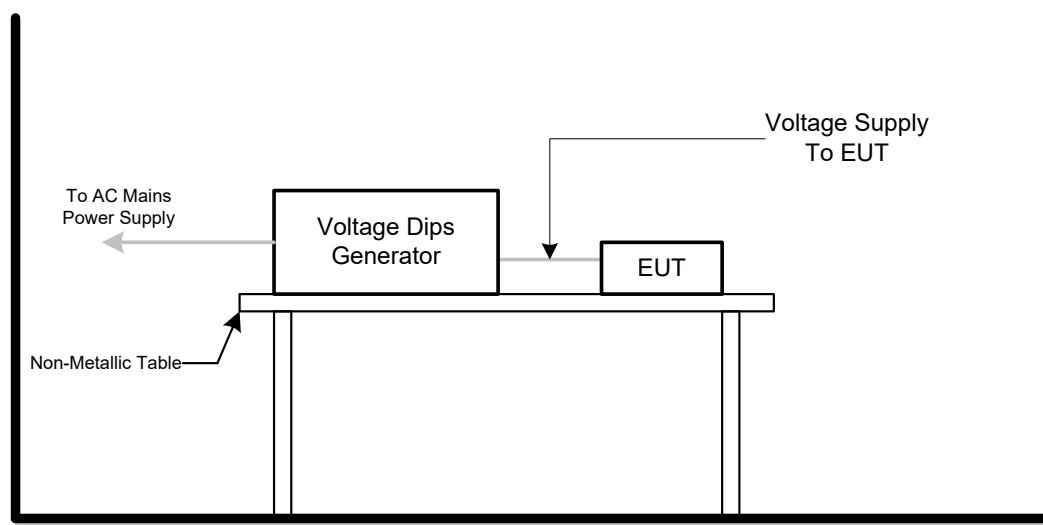

5.11.6 TEST RESULTS

Test Voltage	AC 100V/50Hz, AC 230V/50Hz, AC 240V/50Hz
Test Mode	Mode 1-5, Mode 8-13

AC 100V/50Hz				
Item	Residual Voltage	Cycle	Criteria	Results
Voltage dips	<5%	0.5	B	A
Voltage dips	70%	25	C	A
Voltage Interruption	<5%	250	C	C

AC 230V/50Hz				
Item	Residual Voltage	Cycle	Criteria	Results
Voltage dips	<5%	0.5	B	A
Voltage dips	70%	25	C	A
Voltage Interruption	<5%	250	C	C

AC 240V/50Hz				
Item	Residual Voltage	Cycle	Criteria	Results
Voltage dips	<5%	0.5	B	A
Voltage dips	70%	25	C	A
Voltage Interruption	<5%	250	C	C

6. EUT TEST PHOTO

EN 55032:2015

Radiated emissions up to 1 GHz

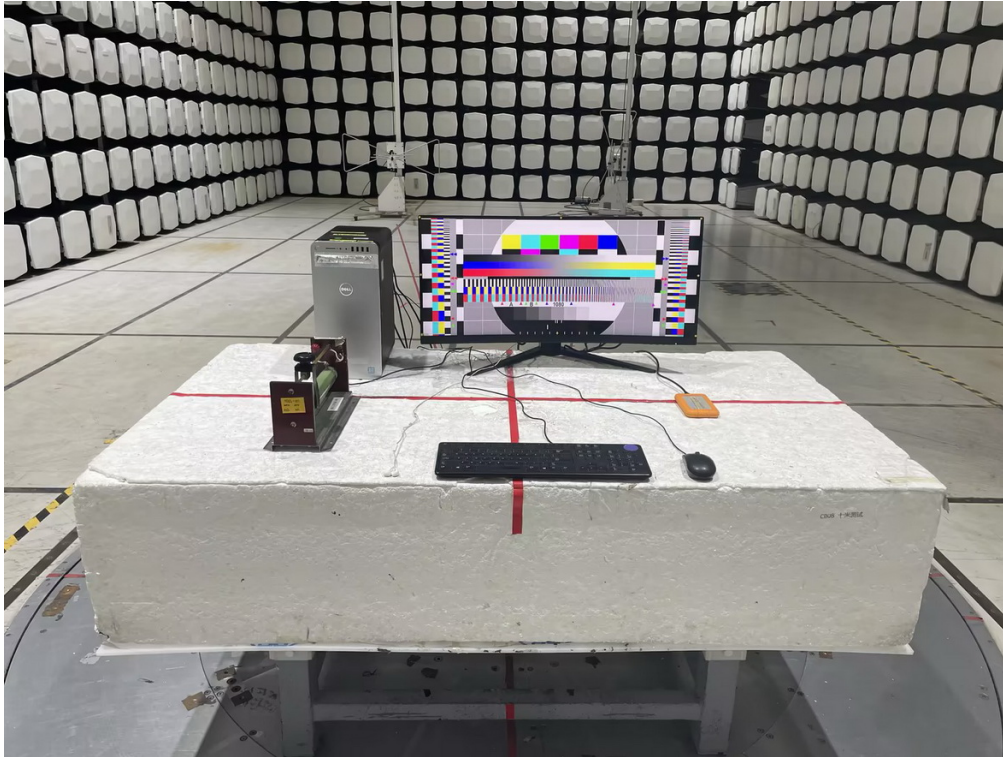

Radiated emissions above 1 GHz

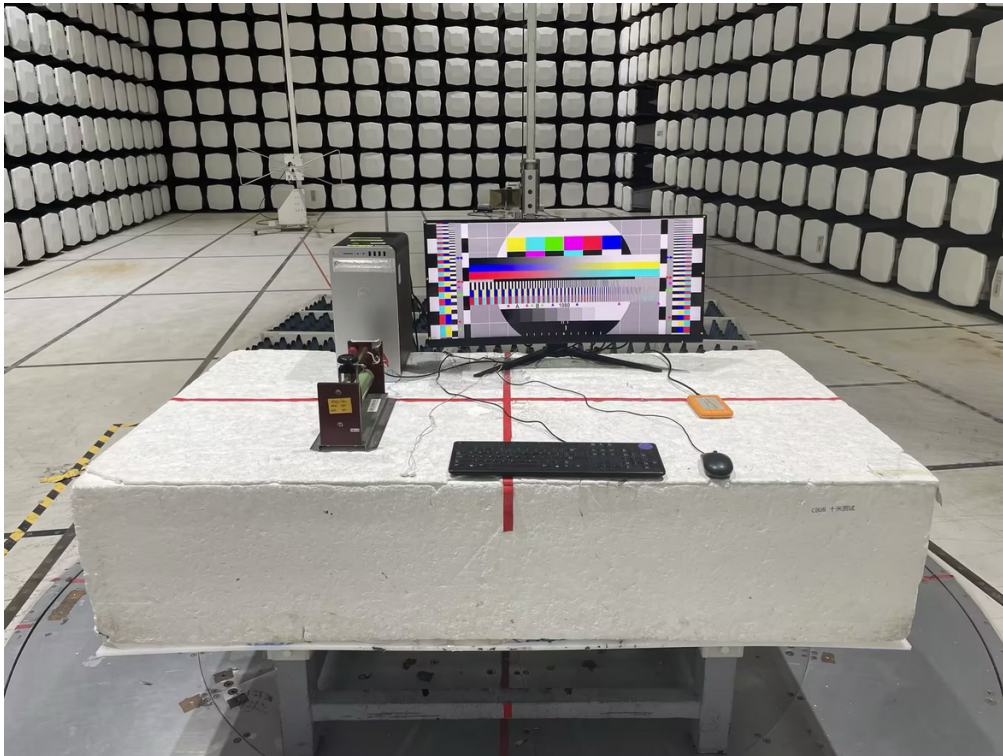

Conducted emissions AC mains power port



EN 55032:2015+A11:2020

Radiated emissions up to 1 GHz

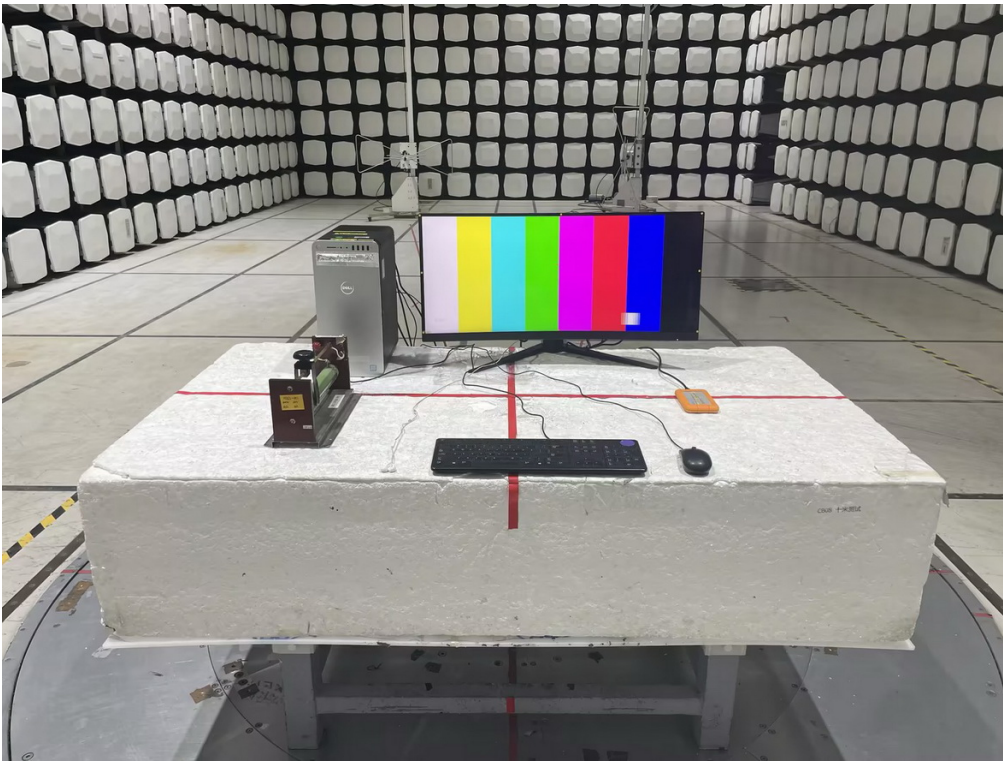

Radiated emissions above 1 GHz

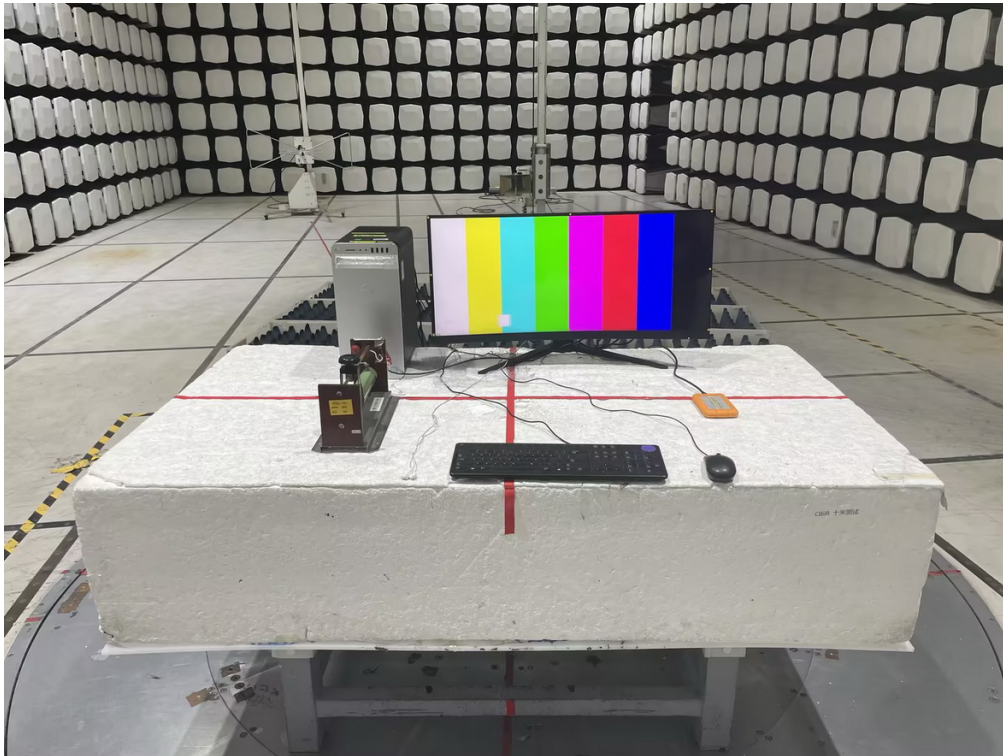

Conducted emissions AC mains power port

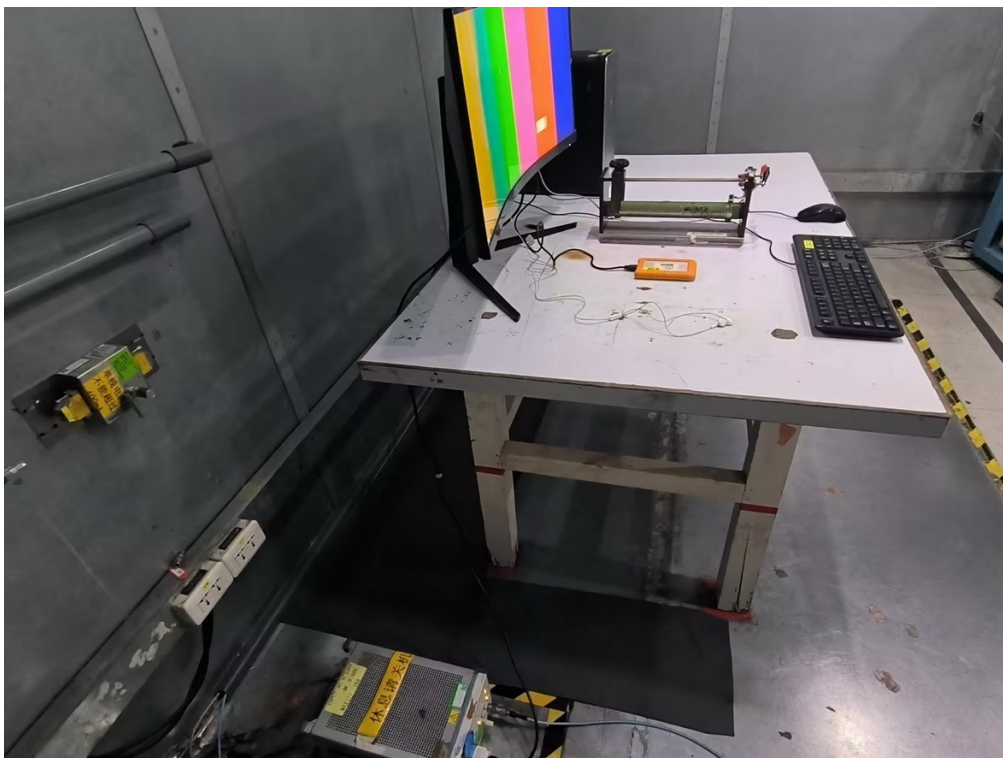

Harmonic current

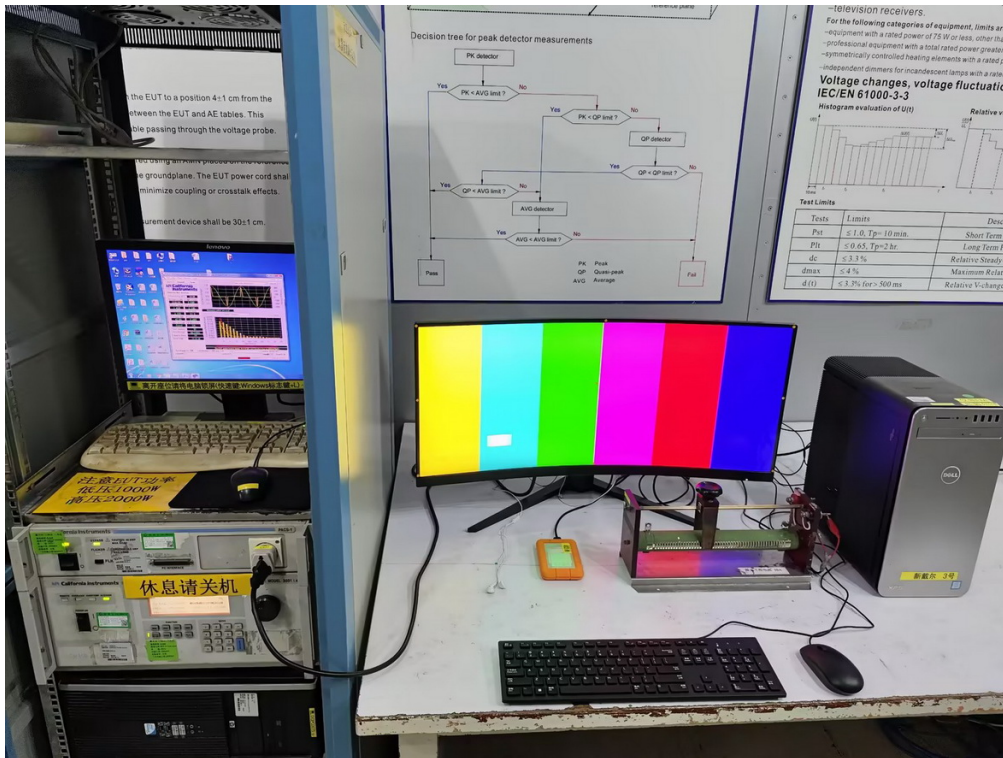

Voltage fluctuations (Flicker)

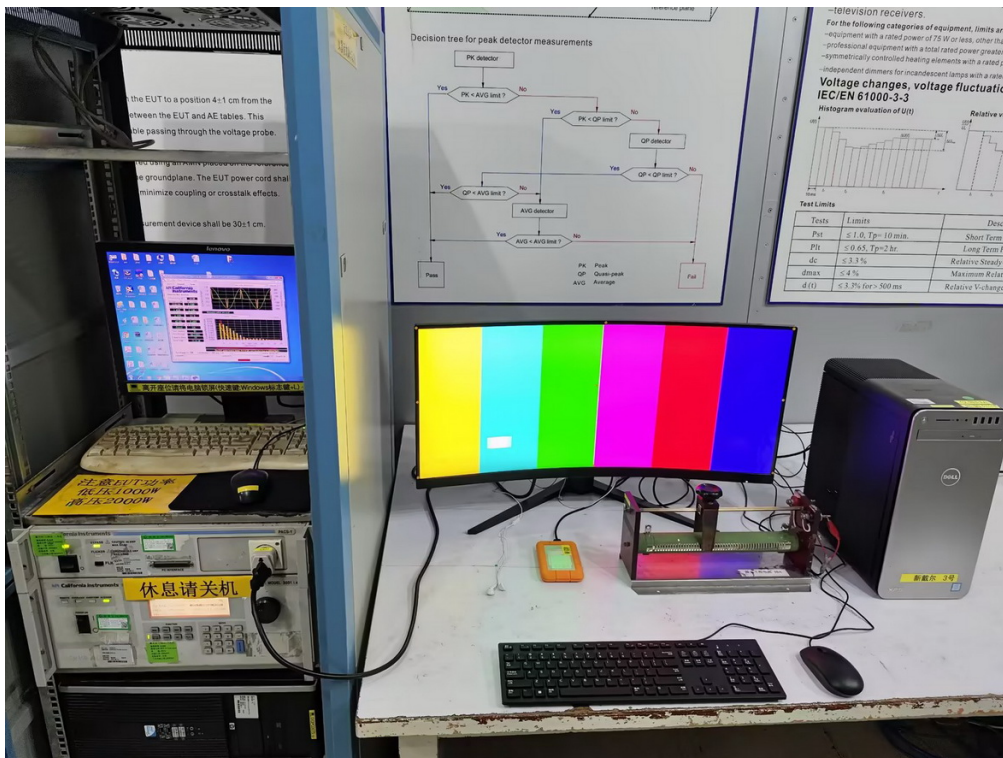

Electrostatic discharge immunity



Radiated, radio-frequency, electromagnetic field immunity – Up to 1GHz



Radiated, radio-frequency, electromagnetic field immunity – Above 1GHz



Electrical fast transient/burst immunity - AC

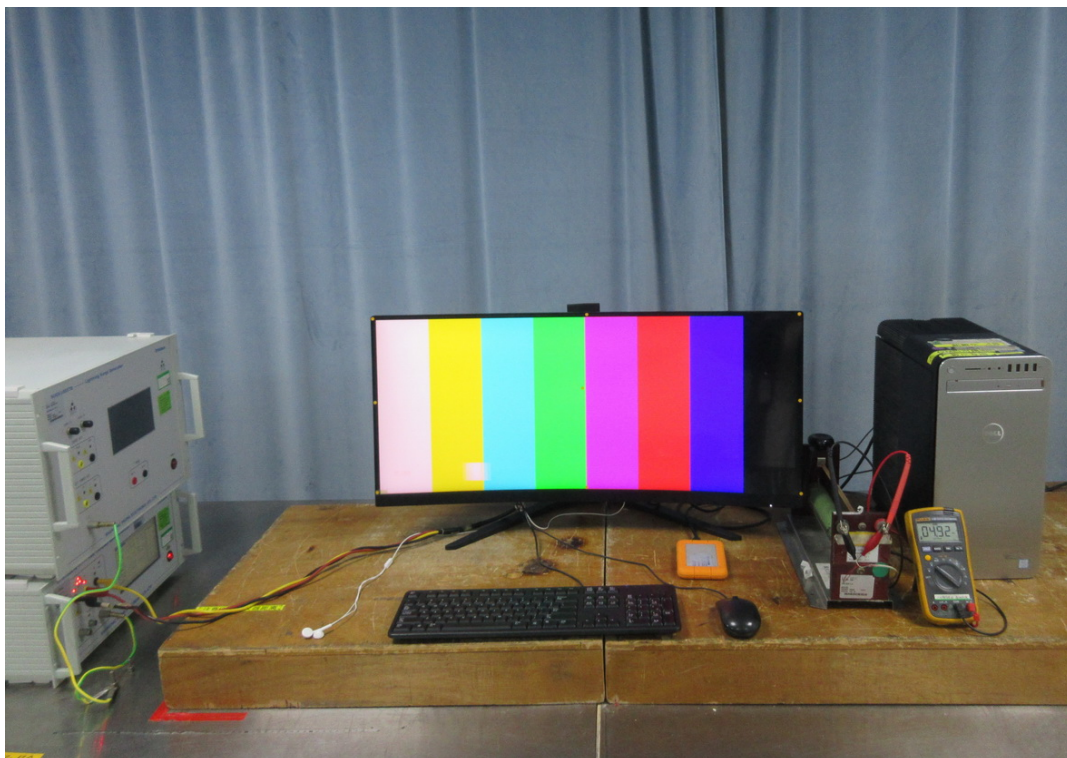

Surge immunity - AC



Immunity to conducted disturbances, induced by radio-frequency fields - AC



Power frequency magnetic field immunity



Voltage dips, short interruptions and voltage variations immunity



End of Test Report