



Certificate #4312.01

TEST REPORT

Product Name: LCD Monitor

Trade Mark: AOC

Model No.: Q27U3CV

Add. Model No.: **Q27U3****, **Q27U3CV****

Report Number: 2311228087EMC-1

Test Standards:

EN 55032:2015, EN 55032:2015/A11:2020, EN 55032:2015/A1:2020, CISPR 32:2015+AMD1:2019, BS EN 55032:2015, BS EN 55032:2015+A1:2020, BS EN 55032:2015+A11:2020, AS/NZS CISPR 32:2015+A1:2020, EN 55035:2017, EN 55035:2017/A11:2020, BS EN 55035:2017, BS EN 55035:2017+A11:2020, CISPR 35:2016, EN 61000-3-2:2014, EN IEC 61000-3-2:2019/A1:2021, BS EN 61000-3-2:2014, BS EN IEC 61000-3-2:2019+A1:2021, EN 61000-3-3:2013, EN 61000-3-3:2013/A1:2019, EN 61000-3-3:2013/A2:2021, BS EN 61000-3-3:2013, BS EN 61000-3-3:2013+A1:2019, BS EN 61000-3-3:2013+A2:2021, (IEC 61000-4-2:2008, IEC 61000-4-3:2020, IEC 61000-4-4:2012, IEC 61000-4-5:2014+AMD1:2017, IEC 61000-4-6:2013, IEC 61000-4-8:2009, IEC 61000-4-11:2020/COR2:2022)

Test Result: PASS

Date of Issue: December 14, 2023

Prepared for:

TPV Electronics (Fujian) Co., Ltd.

Rongqiao Economic and Technological Development Zone, Fuqing City, Fujian Province, P.R. China

Prepared by:

Shenzhen UnionTrust Quality and Technology Co., Ltd.

Unit D/E of 9/F and 16/F, Block A, Building 6, Baoneng science and technology park, Longhua district, Shenzhen, China

TEL: +86-755-2823 0888

FAX: +86-755-2823 0886

Prepared by:

David Chen

David Chen
Senior Project Engineer

Reviewed by:

Robben Chen

Robben Chen
Assistant Manager

Approved by:

Billy Li
Technical Director

Date:

December 14, 2023

Shenzhen UnionTrust Quality and Technology Co., Ltd.

Address: Unit D/E of 9/F and 16/F, Block A, Building 6, Baoneng science and technology park, Longhua district, Shenzhen, China

Tel: +86-755-28230888

Fax: +86-755-28230886

E-mail: info@uttlab.com

<http://www.uttlab.com>

UTTR-EMC-EN55032-V1.2

Version

Version No.	Date	Description
V1.0	December 14, 2023	Original



CONTENTS

1. GENERAL INFORMATION	4
1.1 CLIENT INFORMATION	4
1.2 EUT INFORMATION	4
1.2.1 GENERAL DESCRIPTION OF EUT	4
1.2.2 DESCRIPTION OF ACCESSORIES.....	5
1.3 GENERAL DESCRIPTION OF APPLIED STANDARDS	6
1.4 DESCRIPTION OF SUPPORT UNITS	6
1.5 TEST LOCATION	6
1.6 TEST FACILITY	7
1.7 DEVIATION FROM STANDARDS	7
1.8 ABNORMALITIES FROM STANDARD CONDITIONS	7
1.9 OTHER INFORMATION REQUESTED BY THE CUSTOMER	7
1.10 MEASUREMENT UNCERTAINTY	8
2. TEST SUMMARY	9
3. EQUIPMENT LIST	11
4. TEST CONFIGURATION	14
4.1 ENVIRONMENTAL CONDITIONS FOR TESTING	14
4.1.1 NORMAL OR EXTREME TEST CONDITIONS	14
4.1.2 RECORD OF NORMAL ENVIRONMENT.....	14
4.2 TEST MODES	15
5. PERFORMANCE CRITERIA	16
5.1 FOR EN 55035:2017/A11:2020	16
6. EMC REQUIREMENTS SPECIFICATION	17
6.1 REFERENCE DOCUMENTS FOR TESTING	17
6.2 EMC EMISSION	18
6.2.1 RADIATED EMISSION	18
6.2.2 CONDUCTED EMISSION (AC MAINS POWER PORTS).....	25
6.2.3 HARMONIC CURRENT EMISSIONS.....	28
6.2.4 VOLTAGE FLUCTUATIONS AND FLICKER.....	32
6.2.5 CONDUCTED EMISSION (ASYMMETRIC MODE CONDUCTED EMISSIONS & CONDUCTED DIFFERENTIAL VOLTAGE EMISSIONS)	33
6.3 IMMUNITY (ENCLOSURE PORTS)	37
6.3.1 RF ELECTROMAGNETIC FIELD	37
6.3.2 ELECTROSTATIC DISCHARGE	39
6.3.3 POWER FREQUENCY MAGNETIC FIELD	41
6.4 IMMUNITY (AC MAINS POWER PORTS)	43
6.4.1 ELECTRICAL FAST TRANSIENTS/BURST.....	43
6.4.2 CONTINUOUS INDUCED RF DISTURBANCES.....	45
6.4.3 VOLTAGE DIPS AND VOLTAGE INTERRUPTIONS.....	47
6.4.4 SURGES	49
6.5 IMMUNITY (ANALOGUE/DIGITAL DATA PORTS)	51
6.5.1 CONTINUOUS INDUCED RF DISTURBANCES.....	51
6.5.2 SURGES	53
6.5.3 ELECTRICAL FAST TRANSIENTS/BURST.....	56
APPENDIX 1 PHOTOGRAPHS OF TEST SETUP	58
APPENDIX 2 PHOTOGRAPHS OF EUT CONSTRUCTIONAL DETAILS	66

1. GENERAL INFORMATION

1.1 CLIENT INFORMATION

Applicant:	TPV Electronics (Fujian) Co., Ltd.
Address of Applicant:	Rongqiao Economic and Technological Development Zone, Fuqing City, Fujian Province, P.R. China

1.2 EUT INFORMATION

1.2.1 General Description of EUT

Product Name:	LCD Monitor
Model No.:	Q27U3CV
Add. Model No.:	**Q27U3***, **Q27U3CV**
Trade Mark:	AOC
Rated Voltage:	100-240V~50/60Hz, 1.5A
Classification of MME:	Class B
Highest Internal Frequency:	302.5 MHz
I/O Port:	1 x AC input Port; 1 x HDMI input Port; 2 x Type-C Ports; 1 x Earphone output Port 4 x USB Type-A Ports; 1 x RJ45 Port; 2 x DP Ports
Sample Received Date :	November 20, 2023
Sample Tested Date :	November 27, 2023 to December 8, 2023
Note: The additional model **Q27U3***, **Q27U3CV** is identical with the test model Q27U3CV except the model number for marketing purpose.	
Remark: The above EUT's information was provided by customer. Please refer to the specifications or user's manual for more detailed description.	

1.2.2 Description of Accessories

HDMI Cable	
Description:	HDMI Cable
Cable Type:	Shielded without ferrite
Length:	1.5Meter/1.8Meter

USB Type-C Cable	
Description:	USB Type-C Cable
Cable Type:	Shielded without ferrite
Length:	1.5Meter/1.8Meter

USB 3.0 Cable	
Description:	USB 3.0 Cable
Cable Type:	Shielded without ferrite
Length:	1.5Meter/1.8Meter

DP Cable	
Description:	DP Cable
Cable Type:	Shielded without ferrite
Length:	1.5Meter/1.8Meter

Power Cord	
Description:	Power Cord
Cable Type:	Unshielded without ferrite
Length:	1.5Meter/1.8Meter

1.3 GENERAL DESCRIPTION OF APPLIED STANDARDS

The EUT is a LCD Monitor, according to the specifications of the manufacturers. It must comply with the requirements of the following standards:

EN 55032:2015, EN 55032:2015/A11:2020, EN 55032:2015/A1:2020, CISPR 32:2015+AMD1:2019, BS EN 55032:2015, BS EN 55032:2015+A1:2020, BS EN 55032:2015+A11:2020, AS/NZS CISPR 32:2015+A1:2020, EN 55035:2017, EN 55035:2017/A11:2020, BS EN 55035:2017, BS EN 55035:2017+A11:2020, CISPR 35:2016, EN 61000-3-2:2014, EN IEC 61000-3-2:2019/A1:2021, BS EN 61000-3-2:2014, BS EN IEC 61000-3-2:2019+A1:2021, EN 61000-3-3:2013, EN 61000-3-3:2013/A1:2019, EN 61000-3-3:2013/A2:2021, BS EN 61000-3-3:2013, BS EN 61000-3-3:2013+A1:2019, BS EN 61000-3-3:2013+A2:2021, (IEC 61000-4-2:2008, IEC 61000-4-3:2020, IEC 61000-4-4:2012, IEC 61000-4-5:2014+AMD1:2017, IEC 61000-4-6:2013, IEC 61000-4-8:2009, IEC 61000-4-11:2020/COR2:2022)

All test items have been performed and recorded as per the above standards

1.4 DESCRIPTION OF SUPPORT UNITS

The EUT has been tested with associated equipment below.

Description	Manufacturer	Model No.	Serial Number	Supplied by
PC	DELL	XPS8900	2015AP3055	UnionTrust
keyboard	DELL	KB212-B	CN-0N291F-715	UnionTrust
mouse	DELL	MS111	CN-011D3V-738	UnionTrust
DVD Player	GIEC	BDP-G4305	N/A	UnionTrust
PC work station	DELL	5820	BEC20190001	UnionTrust
Earphone	N/A	QTER01JY	N/A	UnionTrust
Dummy load	N/A	E214887	N/A	UnionTrust
Notebook	Apple	A2251	2020AJ0316	UnionTrust
Tablet	HUAWEI	JDN2-W09	UPK9X20B0300310 0	UnionTrust
Portable SSD	Samsung	T5	S3UMNK0JC00359Z	UnionTrust

1.5 TEST LOCATION

Shenzhen UnionTrust Quality and Technology Co., Ltd.

Address: Unit D/E of 9/F and 16/F, Block A, Building 6, Baoneng science and technology park, Longhua district, Shenzhen, China

Telephone: +86 (0) 755 2823 0888

Fax: +86 (0) 755 2823 0886

Tests were sub-contracted. [Radiated Emission (10 m)]

GRG Metrology & Test Group Co., Ltd.

Address: No. 1301 Guanguang Road, Xinlan Community, Guanlan Street, Longhua District, Shenzhen, 518110, People's Republic of China

Telephone: 86-028-86496515

Shenzhen UnionTrust Quality and Technology Co., Ltd.

Address: Unit D/E of 9/F and 16/F, Block A, Building 6, Baoneng science and technology park, Longhua district, Shenzhen, China

Tel: +86-755-28230888

Fax: +86-755-28230886

E-mail: info@uttlab.com

<http://www.uttlab.com>

UTTR-EMC-EN55032-V1.2

1.6 TEST FACILITY

The test facility is recognized, certified, or accredited by the following organizations:

➤ **Shenzhen UnionTrust Quality and Technology Co., Ltd.**

CNAS-Lab Code: L9069

The measuring equipment utilized to perform the tests documented in this report has been calibrated once a year or in accordance with the manufacturer's recommendations, and is traceable under the ISO/IEC 17025 to international or national standards. Equipment has been calibrated by accredited calibration laboratories.

A2LA-Lab Certificate No.: 4312.01

Shenzhen UnionTrust Quality and Technology Co., Ltd. has been accredited by A2LA for technical competence in the field of electrical testing, and proved to be in compliance with ISO/IEC 17025 General Requirements for the Competence of Testing and Calibration Laboratories and any additional program requirements in the identified field of testing.

ISED Wireless Device Testing Laboratories

CAB identifier: CN0032

FCC Accredited Lab.

Designation Number: CN1194

Test Firm Registration Number: 259480

➤ **GRG Metrology & Test Group Co., Ltd.**

A2LA-Lab Certificate No.: 2861.01

CNAS-Lab Code: L0446

1.7 DEVIATION FROM STANDARDS

None.

1.8 ABNORMALITIES FROM STANDARD CONDITIONS

None.

1.9 OTHER INFORMATION REQUESTED BY THE CUSTOMER

None.

1.10 MEASUREMENT UNCERTAINTY

No.	Item	Measurement Uncertainty
1	Conducted emission 9kHz-150kHz	±3.2 dB
2	Conducted emission 150kHz-30MHz	±2.7 dB
3	Radiated emission 30MHz-1GHz	± 4.6 dB
4	Radiated emission 1GHz-18GHz	± 4.4 dB
5	Harmonic current emissions	±1.4%
6	Voltage fluctuations and flicker	±1.4%
Remark: 95% Confidence Levels, k=2.		

2. TEST SUMMARY

Test Item		Test Requirement	Test Method	Limits	Results
Radiated Emissions	for class A equipment	EN 55032:2015/A1 1:2020 Clause 5	EN 55032:2015/A1 1:2020 Clause 6	Table A2, A3	N/A (Note 1, 2)
	for class B equipment			Table A4, A5	PASS
	for FM receivers			Table A6	N/A (Note 1, 3)
	for outdoor units of home satellite receiving systems			Table A7	N/A (Note 1, 4)
Conducted Emissions	for conducted emissions from the AC mains power ports of Class A equipment	EN 55032:2015/A1 1:2020 Clause 5	EN 55032:2015/A1 1:2020 Clause 6	Table A9	N/A (Note 1, 2)
	for conducted emissions from the AC mains power ports of Class B equipment			Table A10	PASS
	for asymmetric mode conducted emissions from Class A equipment			Table A11	N/A (Note 1, 2)
	for asymmetric mode conducted emissions from Class B equipment			Table A12	PASS
	for conducted differential voltage emissions from Class B equipment			Table A13	N/A (Note 1, 5)
Harmonic Current Emissions		EN IEC 61000-3-2: 2019/A1:2021 Clause 6	EN IEC 61000-3-2: 2019/A1:2021 Clause 6	EN IEC 61000-3-2: 2019/A1:2021 Clause 7	PASS
Voltage Fluctuations and Flicker		EN 61000-3-3: 2013/A2:2021 Clause 4	EN 61000-3-3: 2013/A2:2021 Clause 4	EN 61000-3-3: 2013/A2:2021 Clause 5	PASS
Note: 1) N/A: In the whole report not application. 2) The EUT is Class B equipment. 3) Applicable only to FM receivers, the EUT does not support FM receivers. 4) The EUT not belong to satellite receiving systems. 5) The EUT does not support the TV broadcast receiver tuner ports with an accessible connector, RF modulator output ports and FM broadcast receiver tuner ports with an accessible connector.					

➤ For EN 55035:2017/A11:2020

Part 1: Immunity requirements for enclosure ports			
Test Item	Test Requirement (EN 55035:2017/A11:2020)	Test Method	Results
Power frequency magnetic field	Table Clause 1.1	IEC 61000-4-8:2009	PASS
Continuous RF electromagnetic field disturbances, swept test and spot test	Table Clause 1.2 Table Clause 1.3	IEC 61000-4-3:2020	PASS
Electrostatic Discharge (ESD)	Table Clause 1.4	IEC 61000-4-2:2008	PASS

Part 2: Immunity requirements for AC mains power ports			
Test Item	Test Requirement (EN 55035:2017/A11:2020)	Test Method	Results
Continuous induced RF disturbances	Table Clause 4.1	IEC 61000-4-6:2013	PASS
Voltage dips and Voltage interruptions	Table Clause 4.2 Table Clause 4.3	IEC 61000-4-11:2020/COR2:2022	PASS
Surges	Table Clause 4.4	IEC 61000-4-5:2014+AMD1:2017	PASS
Electrical fast transients/burst	Table Clause 4.5	IEC 61000-4-4:2012	PASS

Part 3: Immunity requirements for DC network power ports			
Test Item	Test Requirement (EN 55035:2017/A11:2020)	Test Method	Results
Continuous induced RF disturbances	Table Clause 3.1	IEC 61000-4-6:2013	N/A (Note 1, 2)
Surges	Table Clause 3.2	IEC 61000-4-5:2014+AMD1:2017	N/A (Note 1, 2)
Electrical fast transients/burst	Table Clause 3.3	IEC 61000-4-4:2012	N/A (Note 1, 2)

Note:

- 1) N/A: In this whole report not application.
- 2) This EUT does not support the DC wired network ports capability.

Part 4: Immunity requirements for analogue/digital data ports			
Test Item	Test Requirement (EN 55035:2017/A11:2020)	Test Method	Results
Continuous induced RF disturbances	Table Clause 2.1	IEC 61000-4-6:2013	PASS
Broadband impulse noise disturbances, repetitive	Table Clause 2.2	EN 55035:2017/A11:2020 Clause 4.2.7	N/A (Note 1, 2)
Broadband impulse noise disturbances, isolated	Table Clause 2.3	EN 55035:2017/A11:2020 Clause 4.2.7	N/A (Note 1, 2)
Surges	Table Clause 2.4	IEC 61000-4-5:2014+AMD1:2017	PASS
Electrical fast transients/burst	Table Clause 2.5	IEC 61000-4-4:2012	PASS

Note:

- 1) N/A: In this whole report not application.
- 2) Applicable only to CPE xDSL ports, all burst durations. This EUT does not support the ports capability.

3. EQUIPMENT LIST

Radiated Emission (3m) Test Equipment List						
Used	Equipment	Manufacturer	Model No.	Serial Number	Cal. date	Cal. Due date
<input checked="" type="checkbox"/>	3m SAC	ETS-LINDGREN	3M	Euroshiedpn-CT001270-1317	22-Jan-2021	21-Jan-2024
<input checked="" type="checkbox"/>	Receiver	R&S	ESIB26	100114	27-Oct-2023	26-Oct-2024
<input checked="" type="checkbox"/>	Broadband Antenna	ETS-LINDGREN	3142E	00201566	26-Mar-2023	25-Mar-2024
<input checked="" type="checkbox"/>	6dB Attenuator	Talent	RA6A5-N-18	18103001	26-Mar-2023	25-Mar-2024
<input checked="" type="checkbox"/>	Preamplifier	HP	8447F	2805A02960	31-Oct-2023	30-Oct-2024
<input checked="" type="checkbox"/>	Double-Ridged Waveguide Horn Antenna (Pre-amplifier)	ETS-LINDGREN	3117-PA	00201541	16-Apr-2023	15-Apr-2025
<input checked="" type="checkbox"/>	Pre-amplifier	ETS-LINDGREN	00118385	00201874	31-Oct-2023	30-Oct-2024
<input checked="" type="checkbox"/>	Multi device Controller	ETS-LINDGREN	7006-001	00160105	N/A	N/A
<input checked="" type="checkbox"/>	Test Software	Audix	e3	Software Version: 9.160323		

Conducted Emission Test						
Used	Equipment	Manufacturer	Model No.	Serial Number	Cal. date	Cal. Due date
<input checked="" type="checkbox"/>	LISN	R&S	ESH2-Z5	860014/024	27-Oct-2023	26-Oct-2024
<input checked="" type="checkbox"/>	LISN	ETS-Lindgren	3816/2SH	00201088	27-Oct-2023	26-Oct-2024
<input checked="" type="checkbox"/>	Receiver	R&S	ESR7	101181	27-Oct-2023	26-Oct-2024
<input checked="" type="checkbox"/>	Pulse Limiter	R&S	ESH3-Z2	0357.8810.54	27-Oct-2023	26-Oct-2024
<input checked="" type="checkbox"/>	ISN	Schwarzbeck	NTFM 8158	NTFM 8158 0113	27-Oct-2023	26-Oct-2024
<input checked="" type="checkbox"/>	Test Software	EZ-EMC	EZ-CON	Software Version: EMC-CON 3A1.1		

Harmonic Current Emissions & Voltage Fluctuations and Flicker Test						
Used	Equipment	Manufacturer	Model No.	Serial Number	Cal. date	Cal. Due date
<input checked="" type="checkbox"/>	5KVA AC POWER SOURCE	California instruments	5001iX+CT S-411	56178	14-Apr-2023	13-Apr-2024
<input checked="" type="checkbox"/>	Flicker & Harmonic Tester	California instruments	PACS-1	72333	14-Apr-2023	13-Apr-2024
<input checked="" type="checkbox"/>	Test Software	California instruments	CTS 4	Software Version: 4.29.0		

Electrostatic Discharge Test						
Used	Equipment	Manufacturer	Model No.	Serial Number	Cal. date	Cal. Due date
<input checked="" type="checkbox"/>	ESD Simulator	TESEQ	NSG438	634	3-Nov-2023	2-Nov-2024

Fast transients common mode & Surges Test (AC Port)						
Used	Equipment	Manufacturer	Model No.	Serial Number	Cal. date	Cal. Due date
<input checked="" type="checkbox"/>	NSG 3040 EMC test system	TESEQ	NSG 3040	2101	31-Oct-2023	30-Oct-2024
<input checked="" type="checkbox"/>	Capacitive coupling clamp	HTEC	H3C	155103	18-Jan-2023	17-Jan-2024

Shenzhen UnionTrust Quality and Technology Co., Ltd.

Address: Unit D/E of 9/F and 16/F, Block A, Building 6, Baoneng science and technology park, Longhua district, Shenzhen, China

Tel: +86-755-28230888

Fax: +86-755-28230886

E-mail: info@uttlab.com

<http://www.uttlab.com>

UTTR-EMC-EN55032-V1.2

RF common mode 0.15 MHz to 80 MHz Test						
Used	Equipment	Manufacturer	Model No.	Serial Number	Cal. date	Cal. Due date
<input checked="" type="checkbox"/>	Conducted Immunity System	Schloder	CDG 6000-75	126B1367	27-Oct-2023	26-Oct-2024
<input checked="" type="checkbox"/>	Coupling/Decoupling network	Schloder	CDN M2+M3-16	A2210363	31-Oct-2023	30-Oct-2024
<input checked="" type="checkbox"/>	6dB Attenuator	Schloder	CDG60100	201411010018	31-Oct-2023	30-Oct-2024
<input checked="" type="checkbox"/>	EM-Clamp	Schloder	EMCL-20	132A1245	31-Oct-2023	30-Oct-2024
<input checked="" type="checkbox"/>	Audio Test System	Audio Precision	ATS-1	ATS1-41075	14-Apr-2023	13-Apr-2024
<input checked="" type="checkbox"/>	Test Software	Dr. Hubert GmbH	IEC/EN610 00-4-6	Software Version: 1.2.0(25.03.2013)		
<input checked="" type="checkbox"/>	Test Software	HTEC	CS5045	Software Version: 2.01		

Voltage dips and interruptions Test						
Used	Equipment	Manufacturer	Model No.	Serial Number	Cal. date	Cal. Due date
<input checked="" type="checkbox"/>	Voltage dips and variation test system	NTEC	HPFS 161P	161503	31-Oct-2023	30-Oct-2024
<input checked="" type="checkbox"/>	Voltage Interruption Simulator with Step Simulator	NTEC	HV1P16	161504	31-Oct-2023	30-Oct-2024

RF electromagnetic field Test						
Used	Equipment	Manufacturer	Model No.	Serial Number	Cal. date	Cal. Due date
<input checked="" type="checkbox"/>	3M Chamber & Accessory Equipment	ETS-Lindgren	3m SAC	Euroshiedpn-C T001270-1317	22-Jan-2021	21-Jan-2024
<input checked="" type="checkbox"/>	Audio Test System	Audio Precision	ATS-1	ATS1-41075	14-Apr-2023	13-Apr-2024
<input checked="" type="checkbox"/>	Log Periodic Antenna	Schwarzbeck	VUSLP 9111E	00041	17-Apr-2023	16-Apr-2024
<input checked="" type="checkbox"/>	Stacked Logarithmic-Periodic Broadband Antenna	Schwarzbeck	STLP 9149	00706	17-Apr-2023	16-Apr-2024
<input checked="" type="checkbox"/>	Electric field probe	Frankonia	EFS-100	711ZX00424	17-Apr-2023	16-Apr-2024
<input checked="" type="checkbox"/>	RF Amplifier	HTEC	HPA 0810-250	MPA2003056	14-Apr-2023	13-Apr-2024
<input checked="" type="checkbox"/>	RF Amplifier	HTEC	HPA 1060-75	MPA2003057	14-Apr-2023	13-Apr-2024
<input checked="" type="checkbox"/>	Audio conditioner	HTEC	PM_ABT/C 35	2020051002	29-Oct-2023	28-Oct-2024
<input checked="" type="checkbox"/>	Microphone	HTEC	FFMP_AB T/C35	2020051001	01-Nov-2023	31-Oct-2024
<input checked="" type="checkbox"/>	MXG Analog Signal Generator	Agilent	N5181A	MY47070613	14-Apr-2023	13-Apr-2024
<input checked="" type="checkbox"/>	EPM-P Series Power Meter	Agilent	E4417A	MY45100705	14-Apr-2023	13-Apr-2024
<input checked="" type="checkbox"/>	Peak and Avg Power Sensor	Agilent	E9323A	MY44420776	14-Apr-2023	13-Apr-2024
<input checked="" type="checkbox"/>	Peak and Avg Power Sensor	Agilent	E9323A	US40410105	14-Apr-2023	13-Apr-2024
<input checked="" type="checkbox"/>	Shielding box	SKET	ABSB_AB T/C35	N/A	N/A	N/A
<input checked="" type="checkbox"/>	Microphone Sensitivity Calibrator	SKET	AC 02	N/A	21-Apr-2023	20-Apr-2024
<input checked="" type="checkbox"/>	Test Software	Suzhou Keleto Electronics Technology Co.,Ltd	EMC-S	Software Version: V1.4.0.57		

Shenzhen UnionTrust Quality and Technology Co., Ltd.

Address: Unit D/E of 9/F and 16/F, Block A, Building 6, Baoneng science and technology park, Longhua district, Shenzhen, China

Tel: +86-755-28230888

Fax: +86-755-28230886

E-mail: info@uttlab.com

<http://www.uttlab.com>

UTTR-EMC-EN55032-V1.2

PFMF Test Equipment List						
Used	Equipment	Manufacturer	Model No.	Serial Number	Cal. Due date	Cal. Interval
<input checked="" type="checkbox"/>	Power supply	SCHAFFNER	NSG1007	54789	Feb. 09, 2024	1 year
<input checked="" type="checkbox"/>	PFMF Generator	SCHAFFNER	INA2141	6003	Jul. 14, 2024	1 year
<input checked="" type="checkbox"/>	PFMF Magnetic antenna	SCHAFFNER	INA-702	711-1115	Jul. 14, 2024	1 year
<input checked="" type="checkbox"/>	Test software	TESEQ	Win2120	Software Version: Ver6.00		

Radiated Emission (10m SAC) Test Equipment List						
Used	Equipment	Manufacturer	Model No.	Serial Number	Cal. Due date	Cal. Interval
<input checked="" type="checkbox"/>	10m SAC	Taihe Mao rui	17.2mX12.1mX8.5m	N/A	2024-08-22	3 year
<input checked="" type="checkbox"/>	EMI Test Receiver	R&S	ESR7	10244	2024-08-11	1 year
<input checked="" type="checkbox"/>	EMI Test Receiver	R&S	ESCI	100145	2024-09-08	1 year
<input checked="" type="checkbox"/>	Bilog Antenna	TESEQ	CBL6143A	26039	2024-07-17	1 year
<input type="checkbox"/>	Bilog Antenna	TESEQ	CBL6143A	32399	2024-08-28	1 year
<input checked="" type="checkbox"/>	Preamplifier	EMEC	EM330	100425	2024-02-06	1 year
<input checked="" type="checkbox"/>	Test Software	EZ	CCS-03A1	N/A	N/A	N/A

Surges Test (Wired network ports) Test Equipment List						
Used	Equipment	Manufacturer	Model No.	Serial Number	Cal. Due date	Cal. Interval
<input checked="" type="checkbox"/>	Surge Simulator	3ctrst	CWS 600G	ES0381813	2024-09-08	1 year
<input checked="" type="checkbox"/>	Coupling decoupling network	3ctrst	SPN 3618T	ES0941720	2024-09-08	1 year
<input checked="" type="checkbox"/>	Coupling decoupling network	TESEQ	CDN118	SL400-187-1	2024-06-09	1 year
<input checked="" type="checkbox"/>	Coupling decoupling network	TESEQ	CDN118	SL400-187-2	2024-06-09	1 year
<input checked="" type="checkbox"/>	Coupling network	TESEQ	INA1881	34755	2024-06-09	1 year
<input checked="" type="checkbox"/>	Coupling network	TESEQ	INA1881	34757	2024-06-09	1 year

Shenzhen UnionTrust Quality and Technology Co., Ltd.

Address: Unit D/E of 9/F and 16/F, Block A, Building 6, Baoneng science and technology park, Longhua district, Shenzhen, China

Tel: +86-755-28230888

Fax: +86-755-28230886

E-mail: info@uttlab.com

<http://www.uttlab.com>

UTTR-EMC-EN55032-V1.2

4. TEST CONFIGURATION

4.1 ENVIRONMENTAL CONDITIONS FOR TESTING

4.1.1 Normal or Extreme Test Conditions

Environment Parameter	Selected Values During Tests		
Test Condition	Ambient		
	Temperature (°C)	Voltage	Relative Humidity (%)
NT/NV	+15 to +35	1. 110~60Hz 2. 230~50Hz	20 to 75 (Except Electrostatic Discharge is 30 to 60)
Remark: 1) NV: Normal Voltage; NT: Normal Temperature			

4.1.2 Record of Normal Environment

Test Item	Temperature (°C)	Relative Humidity (%)	Pressure (kPa)	Sample No.	Tested by
Radiated Emission(3m)	24.9	50.1	100.2	S202311202426-ZJA01/1	Fire Huo
Radiated Emission(10m)	22.1	52	100.1		Yinxiaogang
Conducted Emission	26.9	49.5	100.5		Linson Xie
Voltage Fluctuations and Flicker	25.6	58.9	100.1		Bowie Zhang
RF electromagnetic field	23.4	48.9	100.1		
Electrostatic Discharge	23.4	48.9	100.1		
Fast transients, common mode	25.6	58.9	100.1		
RF common mode 0.15 MHz to 80 MHz					
Voltage dips and interruptions					
Surges	25.6	49.2	100.4		Lucas Ouyang
Power frequency magnetic field					

4.2 TEST MODES

Test Modes									
No.	Test Voltage	Input ports	Input source	Cable Length (Meter)	Pattern	Resolution	Rotatio	Stand Position	Audio
1	230V~50Hz	HDMI 1	PC	1.8	H Pattern	800*600@60Hz	Landscape	UP	With Earphone
2			PC	1.8	H Pattern	1920*1080@60Hz	Landscape	UP	With Earphone
3			PC	1.8	H Pattern	2560*1440@60Hz	Landscape	UP	With Earphone
4			PC	1.8	H Pattern	2560*1440@75Hz	Landscape	UP	With Earphone
5			PC	1.8	BT 471-1	2560*1440@75Hz	Landscape	UP	Without Earphone
6*			PC	1.8	BT 471-1	2560*1440@75Hz	Landscape	UP	With Earphone
7			PC	1.5	H Pattern	2560*1440@75Hz	Landscape	UP	Without Earphone
8			DVD	1.8	BT 471-1	--	Landscape	UP	With Earphone
9			DVD	1.5	BT 471-1	--	Landscape	UP	Without Earphone
10		DP 1	PC	1.8	BT 471-1	800*600@60Hz	Landscape	UP	With Earphone
11			PC	1.8	BT 471-1	1920*1080@60Hz	Landscape	UP	With Earphone
12			PC	1.8	BT 471-1	2560*1440@75Hz	Landscape	UP	With Earphone
13			PC	1.5	BT 471-1	2560*1440@75Hz	Landscape	UP	Without Earphone
14		USB Type-C	PC	1.8	BT 471-1	800*600@60Hz	Landscape	UP	With Earphone
15			PC	1.8	BT 471-1	1920*1080@60Hz	Landscape	UP	With Earphone
16			PC	1.8	BT 471-1	2560*1440@75Hz	Landscape	UP	With Earphone
17			PC	1.5	BT 471-1	2560*1440@75Hz	Landscape	UP	Without Earphone
18	Worst case from Test mode 1~17 with 1.5m Power Cord						Landscape	Down	With Earphone
19	Worst case from Test mode 1~17 with 1.8m Power Cord						Portrait (-90 degree)	UP	With Earphone
20	Worst case from Test mode 1~17 with 1.5m Power Cord						Portrait (-270 degree)	Down	With Earphone
21	110V~60Hz	Worst case from Test mode 1~20							

Note:

- 1) "*"Means the worst test mode. "**" Indicates that the current mode is the worst mode.
- 2) All test modes are performed at maximum brightness, contrast, and volume.

5. PERFORMANCE CRITERIA

5.1 FOR EN 55035:2017/A11:2020

➤ **<General>**

General performance criteria are defined in 8.2, 8.3 and 8.4. These criteria shall be used during the testing of primary functions where no relevant annex is applicable.

When assessing the impact of a disturbance on a function, the assessment should take into consideration the function’s performance prior to the application of the disturbance and only identify as failures those changes in performance that are a result of the disturbance.

➤ **<Performance criterion A>**

The equipment shall continue to operate as intended without operator intervention. No degradation of performance, loss of function or change of operating state is allowed below a performance level specified by the manufacturer when the equipment is used as intended. The performance level may be replaced by a permissible loss of performance. If the minimum performance level or the permissible performance loss is not specified by the manufacturer, then either of these may be derived from the product description and documentation, and by what the user may reasonably expect from the equipment if used as intended.

➤ **<Performance criterion B>**

During the application of the disturbance, degradation of performance is allowed. However, no unintended change of actual operating state or stored data is allowed to persist after the test.

After the test, the equipment shall continue to operate as intended without operator intervention; no degradation of performance or loss of function is allowed, below a performance level specified by the manufacturer, when the equipment is used as intended. The performance level may be replaced by a permissible loss of performance.

If the minimum performance level (or the permissible performance loss), or recovery time, is not specified by the manufacturer, then either of these may be derived from the product description and documentation, and by what the user may reasonably expect from the equipment if used as intended.

➤ **<Performance criterion C>**

Loss of function is allowed, provided the function is self-recoverable, or can be restored by the operation of the controls by the user in accordance with the manufacturer’s instructions. A reboot or re-start operation is allowed.

Information stored in non-volatile memory, or protected by a battery backup, shall not be lost.

➤ **PERFORMANCE CRITERION FOR OTHERS FUNCTION**

Function	Performance criterion
Broadcast reception function	Refer to Annex A.4 of EN 55035:2017/A11:2020
Print function	Refer to Annex B.3 of EN 55035:2017/A11:2020
Scan function	Refer to Annex C.3 of EN 55035:2017/A11:2020
Display and display output functions	Refer to Annex D.3 of EN 55035:2017/A11:2020
Musical tone generating function	Refer to Annex E.3 of EN 55035:2017/A11:2020
Networking functions	Refer to Annex F.3.3 & F.4 of EN 55035:2017/A11:2020
Audio output function	Refer to Annex G.7 of EN 55035:2017/A11:2020
Telephony function	Refer to Annex H.7 of EN 55035:2017/A11:2020

6. EMC REQUIREMENTS SPECIFICATION

6.1 REFERENCE DOCUMENTS FOR TESTING

**EN 61000-3-2:2014, EN IEC 61000-3-2:2019/A1:2021,
BS EN 61000-3-2:2014, BS EN IEC 61000-3-2:2019+A1:2021,**
Electromagnetic compatibility (EMC) Part 3-2: Limits — Limits for harmonic current emissions (equipment input current ≤ 16 A per phase)

**EN 61000-3-3:2013, EN 61000-3-3:2013/A1:2019, EN 61000-3-3:2013/A2:2021,
BS EN 61000-3-3:2013, BS EN 61000-3-3:2013+A1:2019, BS EN 61000-3-3:2013+A2:2021,**
Electromagnetic compatibility (EMC) Part 3-3: Limits – Limitation of voltage changes, voltage fluctuations and flicker in public low-voltage supply systems, for equipment with rated current ≤ 16 A per phase and not subject to conditional connection

**EN 55032:2015, EN 55032:2015/A11:2020, EN 55032:2015/A1:2020,
CISPR 32:2015+AMD1:2019, AS/NZS CISPR 32:2015+A1:2020,
BS EN 55032:2015, BS EN 55032:2015+A1:2020, BS EN 55032:2015+A11:2020**
Electromagnetic compatibility of multimedia equipment - Emission Requirements

**EN 55035:2017, EN 55035:2017/A11:2020,
BS EN 55035:2017, BS EN 55035:2017+A11:2020, CISPR 35:2016,**
Electromagnetic compatibility of multimedia equipment - Immunity requirements

IEC 61000-4-2:2008
Electromagnetic compatibility (EMC) - Part 4-2: Testing and measurement techniques - Electrostatic discharge immunity test

IEC 61000-4-3:2020
Electromagnetic compatibility (EMC) - Part 4-3: Testing and measurement techniques - Radiated, radio-frequency, electromagnetic field immunity test

IEC 61000-4-4:2012
Electromagnetic compatibility (EMC) - Part 4-4: Testing and measurement techniques - Electrical fast transient/burst immunity test

IEC 61000-4-5:2014+AMD1:2017
Electromagnetic compatibility (EMC) - Part 4-5: Testing and measurement techniques - Surge immunity test

IEC 61000-4-6:2013
Electromagnetic compatibility (EMC) - Part 4-6: Testing and measurement techniques - Immunity to conducted disturbances, induced by radio-frequency fields

IEC 61000-4-8:2009
Electromagnetic compatibility (EMC) - Part 4-8: Testing and measurement techniques - Power frequency magnetic field immunity test

IEC 61000-4-11:2020
Electromagnetic compatibility (EMC) - Part 4-11: Testing and measurement techniques - Voltage dips, short interruptions and voltage variations immunity tests

6.2 EMC EMISSION

6.2.1 Radiated Emission

Test Requirement: EN 55032:2015/A11:2020 Clause 5

Test Method: EN 55032:2015/A11:2020 Clause 6

Receiver Setup:

Frequency: (f) (MHz)	Detector type	Measurement receiver bandwidth	
		RBW	VBW
$30 \leq f \leq 1\,000$	Quasi Peak	120 kHz	300 kHz
$f \geq 1000$	Peak	1 MHz	3 MHz
	Average	1 MHz	3 MHz

Measured frequency range

Table 1 – Required highest frequency for radiated measurement	
Highest internal frequency (Fx)	Highest measured frequency
$F_x \leq 108\text{ MHz}$	1 GHz
$108\text{ MHz} < F_x \leq 500\text{ MHz}$	2 GHz
$500\text{ MHz} < F_x \leq 1\text{ GHz}$	5 GHz
$F_x > 1\text{ GHz}$	$5 \times F_x$ up to a maximum of 6 GHz

NOTE 1 For FM and TV broadcast receivers, Fx is determined from the highest frequency generated or used excluding the local oscillator and tuned frequencies.
 NOTE 2 Fx is defined in 3.1.18.
 NOTE 3 For outdoor units of home satellite receiving systems highest measured frequency shall be 18 GHz.

Limit:

Class B

Table A.4 – Requirements for radiated emissions at frequencies up to 1 GHz for class B equipment

Table clause	Frequency range (MHz)	Measurement receiver bandwidth			Class B limits dB(µV/m)
		Facility (see Table A.1)	Distance m	Detector type / bandwidth	
A4.1	30 to 230	OATS/SAC	10	Quasi Peak / 120 kHz	30
	230 to 1 000				37
A4.2	30 to 230	OATS/SAC	3		40
	230 to 1 000				47
A4.3	30 to 230	FAR	10	32 to 25	
	230 to 1 000			32	
A4.4	30 to 230	FAR	3	42 to 35	
	230 to 1 000			42	

Apply only table clause A4.1 or A4.2 or A4.3 or A4.4 across the entire frequency range. These requirements are not applicable to the local oscillator and harmonics frequencies of equipment covered by Table A.6.

Table A.5 – Requirements for radiated emissions at frequencies above 1 GHz for class B equipment

Table clause	Frequency range (MHz)	Measurement receiver bandwidth			Class B limits dB(µV/m)
		Facility (see Table A.1)	Distance m	Detector type / bandwidth	
A5.1	1 000 to 3 000	FSOATS	3	Average / 1 MHz	50
	3 000 to 6 000				54
A5.2	1 000 to 3 000			Peak / 1 MHz	70
	3 000 to 6 000				74

Apply A5.1 and A5.2 across the frequency range from 1 000 MHz to the highest required frequency of measurement derived from Table 1.

Shenzhen UnionTrust Quality and Technology Co., Ltd.

Address: Unit D/E of 9/F and 16/F, Block A, Building 6, Baoneng science and technology park, Longhua district, Shenzhen, China

Tel: +86-755-28230888

Fax: +86-755-28230886

E-mail: info@uttlab.com

<http://www.uttlab.com>

UTTR-EMC-EN55032-V1.2

Test Setup:

Test setup for radiated emissions of tabletop equipment

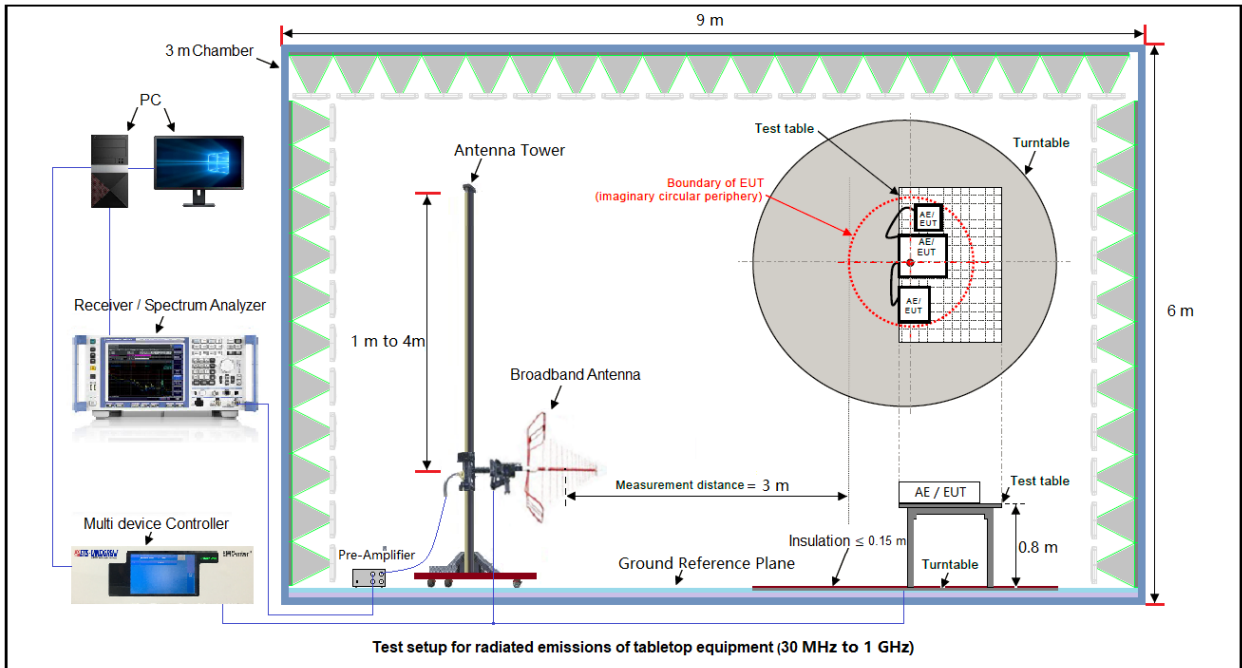

Figure 1. 30 MHz to 1 GHz @ 3 Meter test distance

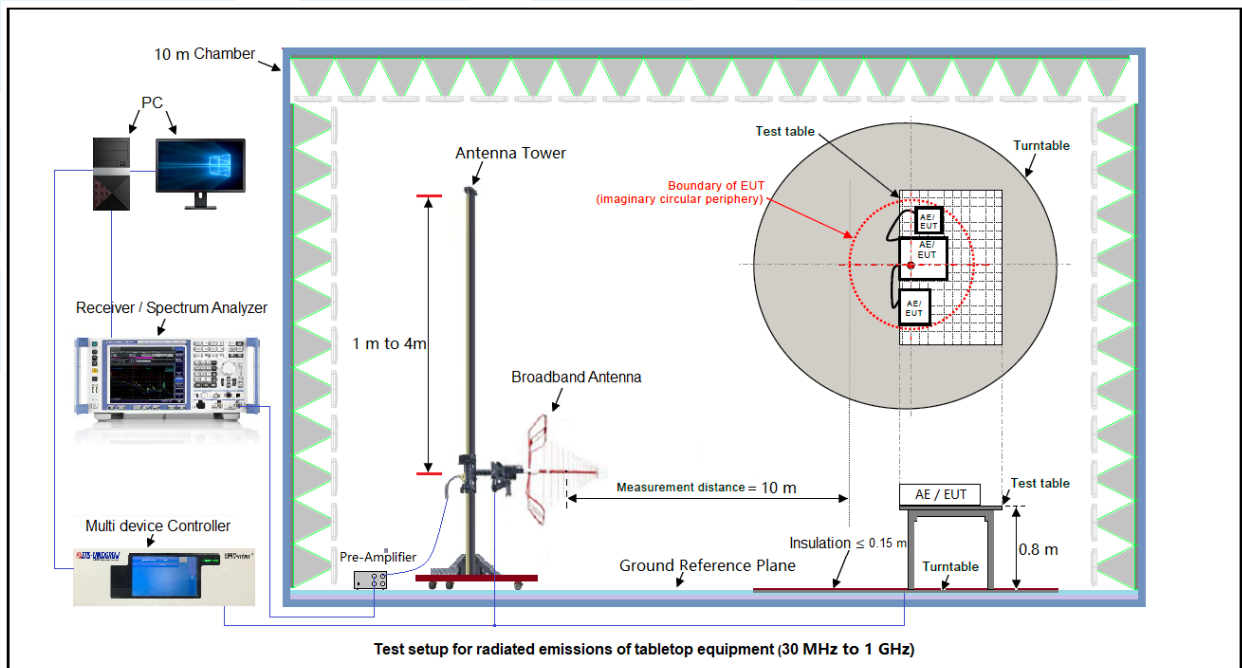

Figure 1. 30 MHz to 1 GHz @ 10 Meter test distance

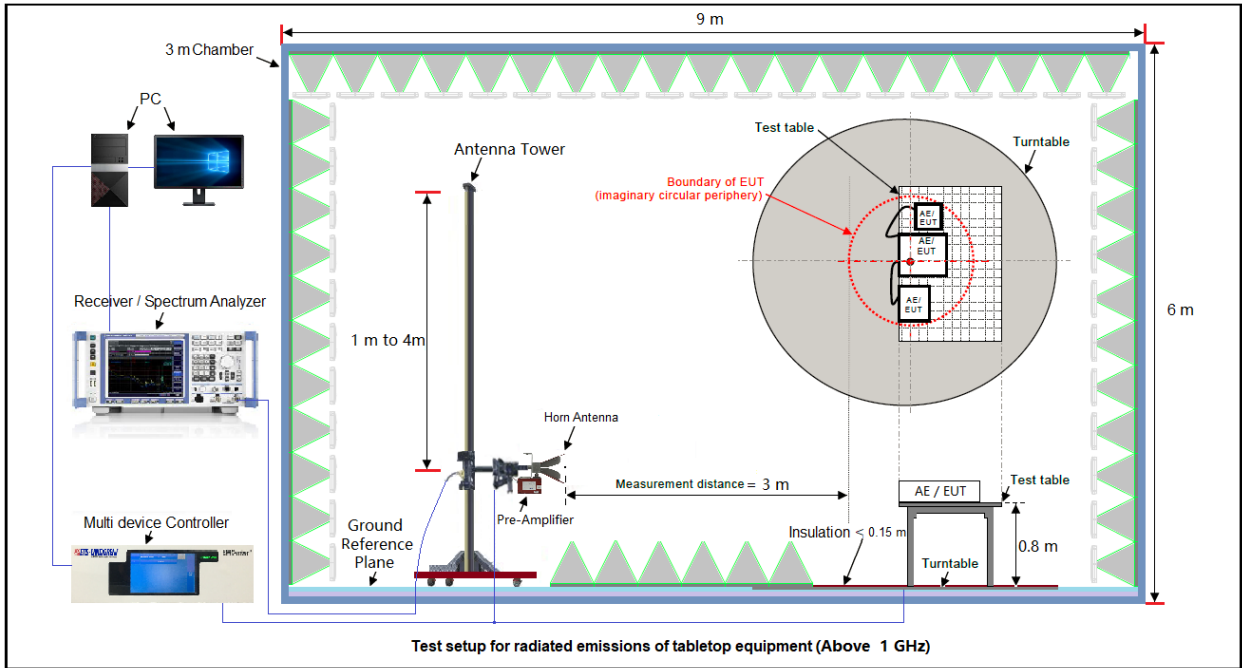

Figure 2. Above 1 GHz

Test Procedures:

1. From 30 MHz to 1GHz test procedure as below:

- 1) The radiated emissions were tested in a semi-anechoic chamber.
- 2) The Product was placed on the non-conductive turntable 0.8 m or 0.1 m above the ground at a chamber.
- 3) Set the spectrum analyzer/receiver in Peak detector, Max Hold mode, and 120 kHz RBW. Record the maximum field strength of all the pre-scan process in the full band when the antenna is varied between 1~4 m in both horizontal and vertical, and the turntable is rotated from 0 to 360 degrees.
- 4) For each frequency whose maximum record was higher or close to limit, measure its QP value: vary the antenna's height and rotate the turntable from 0 to 360 degrees to find the height and degree where Product radiated the maximum emission, then set the test frequency analyzer/receiver to QP Detector and specified bandwidth with Maximum Hold Mode, and record the maximum value.

2. Above 1GHz test procedure as below:

- 1) The radiated emissions were tested in a fully Anechoic Chamber.
- 2) Set the spectrum analyzer/receiver in Peak detector, Max Hold mode, and 1MHz RBW. Record the maximum field strength of all the pre-scan process in the full band when the antenna is varied in both horizontal and vertical, and the turntable is rotated from 0 to 360 degrees.
- 3) For each frequency whose maximum record was higher or close to limit, measure its AV value: rotate the turntable from 0 to 360 degrees to find the degree where Product radiated the maximum emission, then set the test frequency analyzer/receiver to AV value and specified bandwidth with Maximum Hold Mode, and record the maximum value.

Equipment Used: Refer to section 3 for details.

Test Result: Pass

The worst measurement data as follows:

Below 1GHz(Quasi Peak): 10 Meter test distance

Test Mode 6

Horizontal

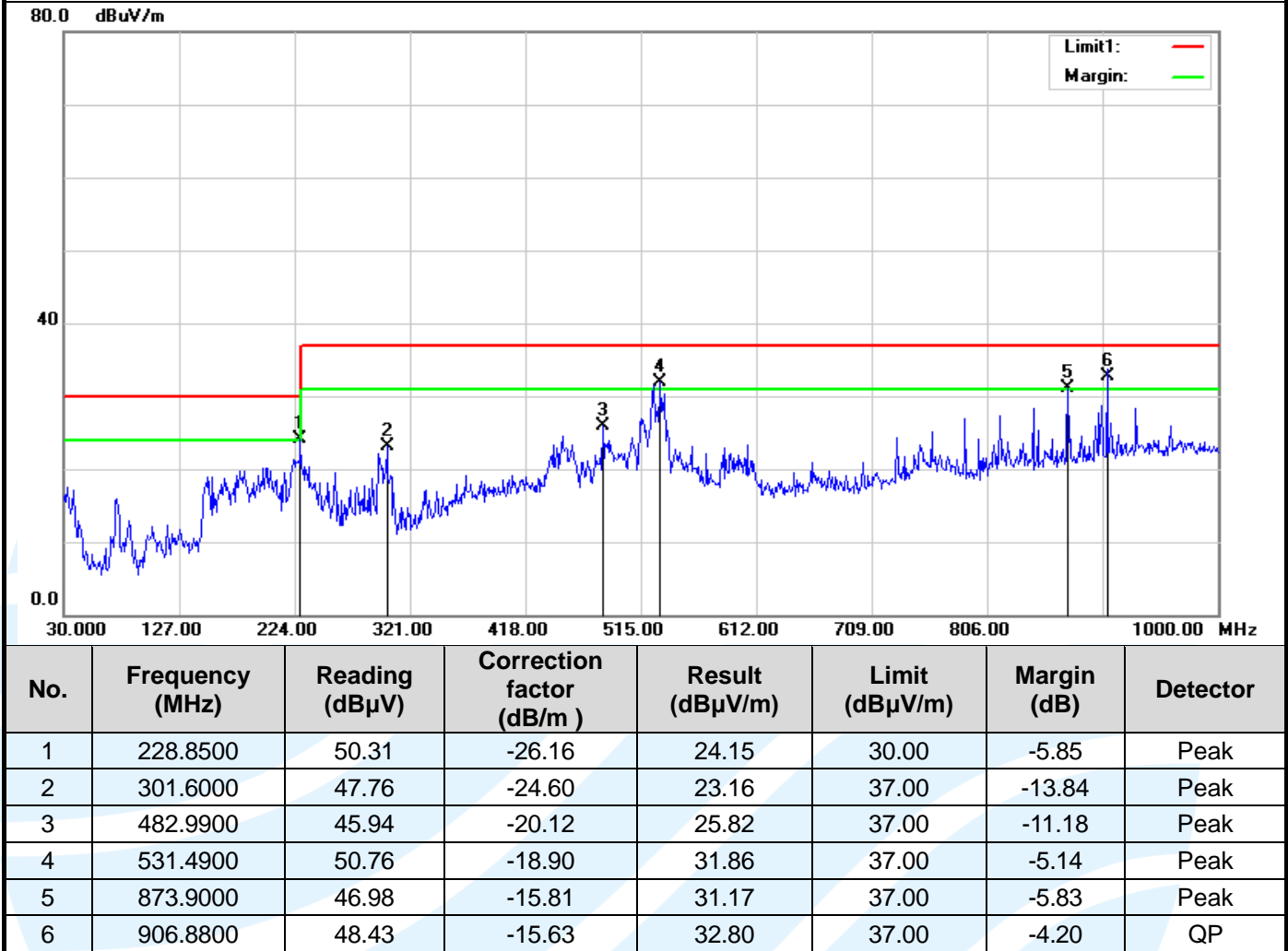

Shenzhen UnionTrust Quality and Technology Co., Ltd.

Address: Unit D/E of 9/F and 16/F, Block A, Building 6, Baoneng science and technology park, Longhua district, Shenzhen, China

Tel: +86-755-28230888

Fax: +86-755-28230886

E-mail: info@uttlab.com

<http://www.uttlab.com>

UTTR-EMC-EN55032-V1.2

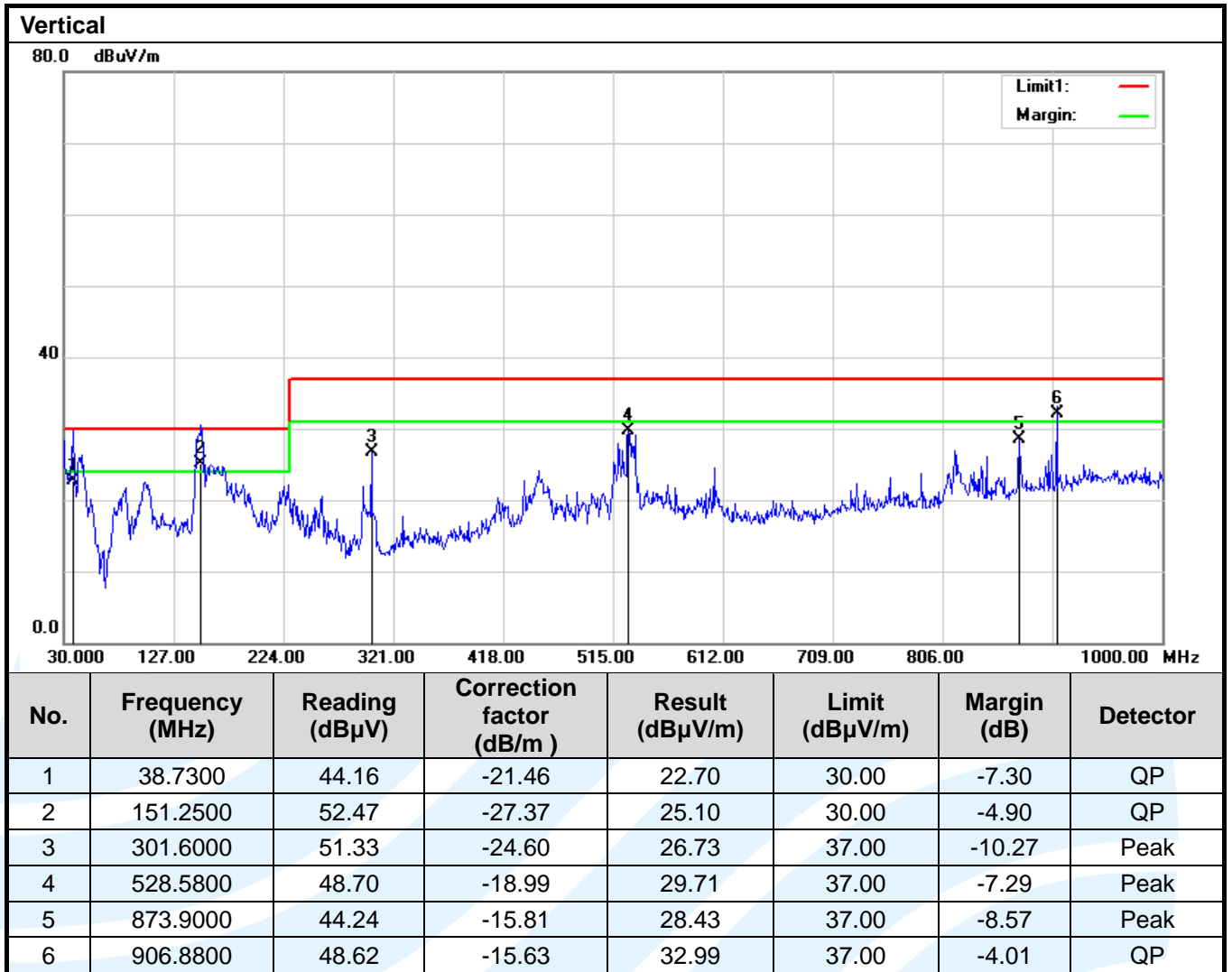

Remark: The testing of Radiated Emissions @10 Meter test distance was performed in GRG Metrology & Test Group Co., Ltd.

Above 1GHz(Peak & Average)
 Test Mode 6
 Horizontal

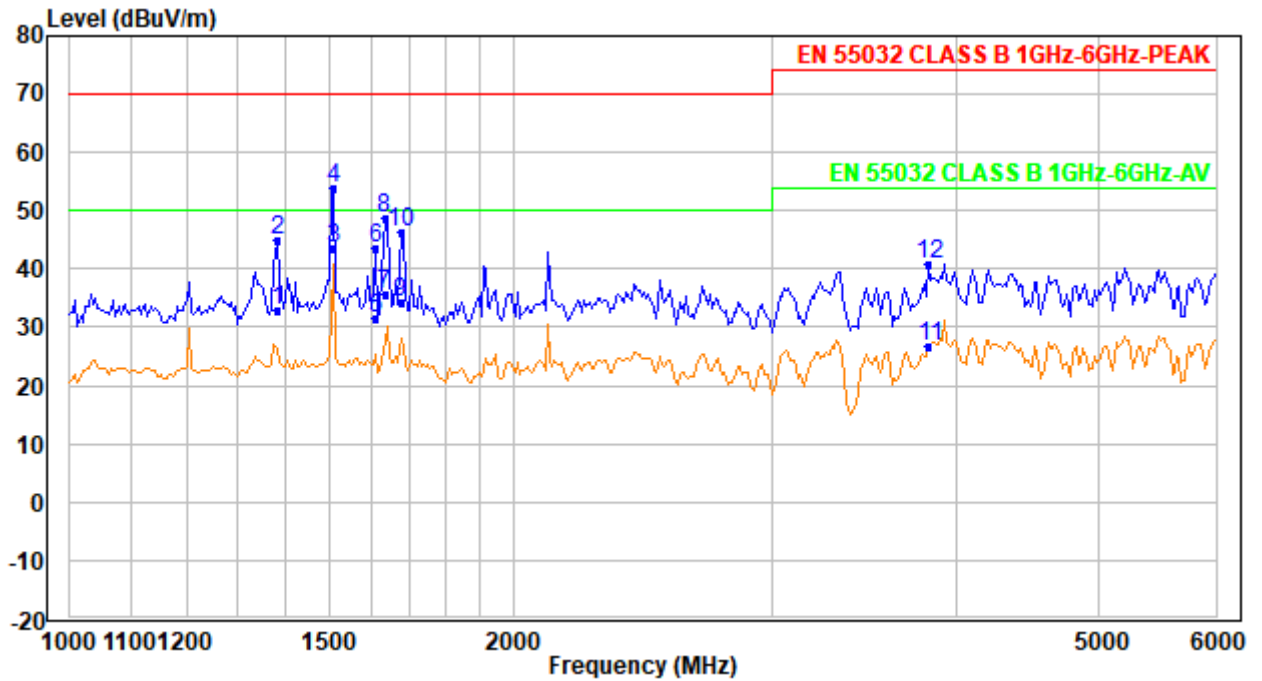

No.	Frequency (MHz)	Reading (dB μ V)	Correction factor (dB)	Result (dB μ V/m)	Limit (dB μ V/m)	Margin (dB)	Remark
1	1381.491	45.63	-12.60	33.03	50.00	-16.97	Average
2	1381.491	57.63	-12.60	45.03	70.00	-24.97	Peak
3	1511.240	55.87	-12.19	43.68	50.00	-6.32	Average
4	1511.240	66.00	-12.19	53.81	70.00	-16.19	Peak
5	1612.141	43.39	-11.88	31.51	50.00	-18.49	Average
6	1612.141	55.39	-11.88	43.51	70.00	-26.49	Peak
7	1635.463	47.34	-11.77	35.57	50.00	-14.43	Average
8	1635.463	60.34	-11.77	48.57	70.00	-21.43	Peak
9	1677.091	45.89	-11.57	34.32	50.00	-15.68	Average
10	1677.091	57.89	-11.57	46.32	70.00	-23.68	Peak
11	3830.219	29.66	-2.76	26.90	54.00	-27.10	Average
12	3830.219	43.66	-2.76	40.90	74.00	-33.10	Peak

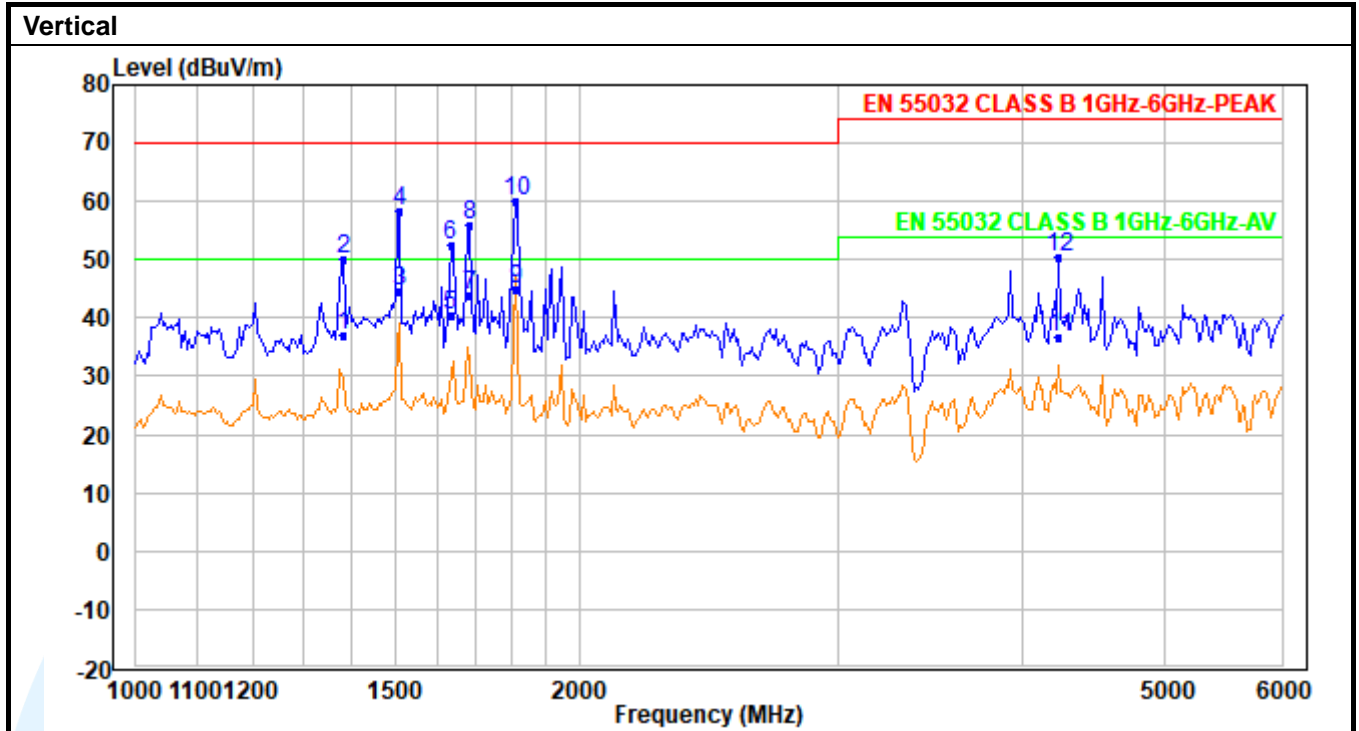

No.	Frequency (MHz)	Reading (dBμV)	Correction factor (dB/m)	Result (dBμV/m)	Limit (dBμV/m)	Margin (dB)	Remark
1	1381.491	49.79	-12.60	37.19	50.00	-12.81	Average
2	1381.491	62.79	-12.60	50.19	70.00	-19.81	Peak
3	1511.240	56.63	-12.19	44.44	50.00	-5.56	Average
4	1511.240	70.63	-12.19	58.44	70.00	-11.56	Peak
5	1635.463	52.14	-11.77	40.37	50.00	-9.63	Average
6	1635.463	64.14	-11.77	52.37	70.00	-17.63	Peak
7	1683.124	55.42	-11.54	43.88	50.00	-6.12	Average
8	1683.124	67.42	-11.54	55.88	70.00	-14.12	Peak
9	1808.442	55.96	-10.95	45.01	50.00	-4.99	Average
10	1808.442	70.96	-10.95	60.01	70.00	-9.99	Peak
11	4235.331	38.65	-2.05	36.60	54.00	-17.40	Average
12	4235.331	52.65	-2.05	50.60	74.00	-23.40	Peak

Remark:

1. Correct Factor = Antenna Factor + Cable Loss - Amplifier Gain, the value was added to Original Receiver Reading by the software automatically.
2. Result = Reading + Correct Factor.
3. Margin = Result - Limit
4. All possible modes of operation were investigated, and testing at two nominal voltages of 230V~50Hz and 110V~60Hz, only the worst case emissions reported.

Shenzhen UnionTrust Quality and Technology Co., Ltd.

Address: Unit D/E of 9/F and 16/F, Block A, Building 6, Baoneng science and technology park, Longhua district, Shenzhen, China

Tel: +86-755-28230888

Fax: +86-755-28230886

E-mail: info@uttlab.com

<http://www.uttlab.com>

UTTR-EMC-EN55032-V1.2

6.2.2 Conducted Emission (AC mains power ports)

Test Requirement: EN 55032:2015/A11:2020 Clause 5

Test Method: EN 55032:2015/A11:2020 Clause 6

Limit:

Class B

Table A.10 – Requirements for conducted emissions from the AC mains power ports of Class B equipment

Table clause	Frequency range (MHz)	Coupling device (see Table A.8)	Detector type / bandwidth	Class B limits dB(μV)
A10.1	0.15 to 0.5	AMN	Quasi Peak / 9 kHz	66 to 56
	0.5 to 5			56
	5 to 30			60
A10.1	0.15 to 0.5	AMN	Average / 9 kHz	56 to 46
	0.5 to 5			46
	5 to 30			50

Apply A10.1 and A10.2 across the entire frequency range.

Test Setup:

Test setup for conducted emissions of tabletop equipment

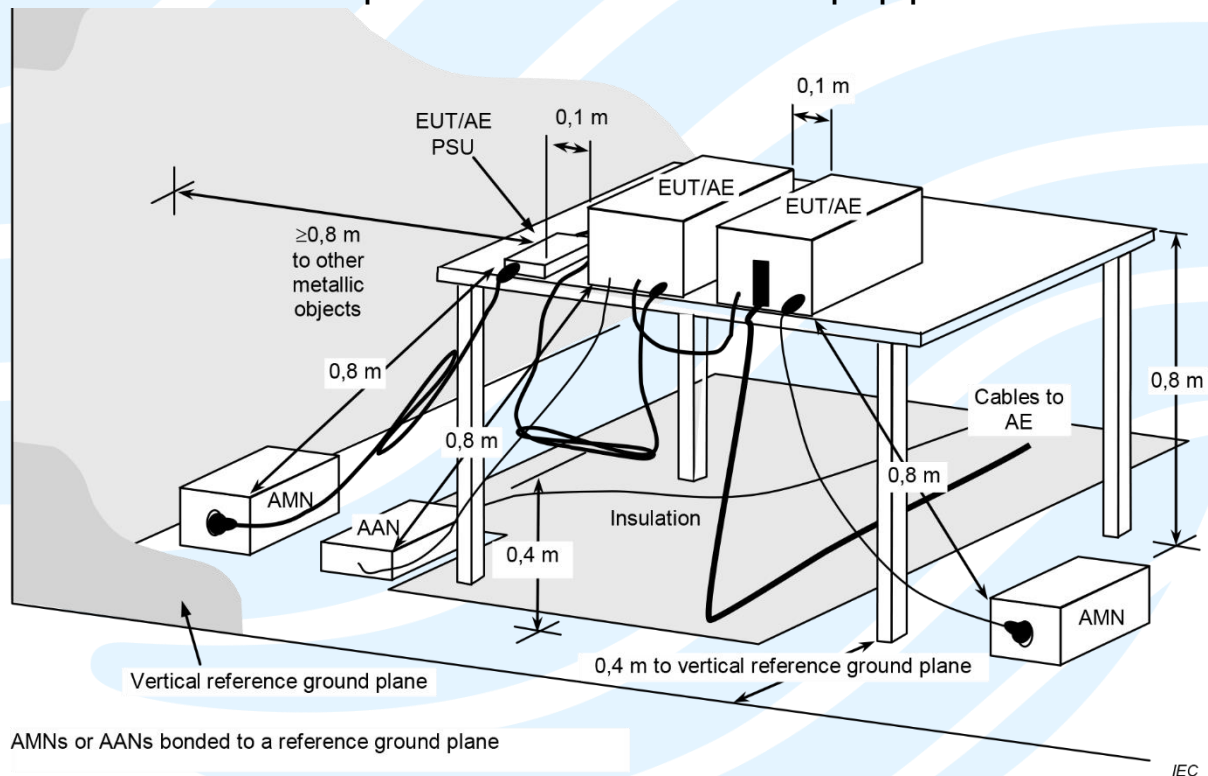

Test Procedures:

- 1) The mains terminal disturbance voltage test was conducted in a shielded room.
- 2) The EUT was connected to AC power source through a LISN 1 (Line Impedance Stabilization Network) which provides a 50Ω/50μH + 5Ω linear impedance. The power cables of all other units of the EUT were connected to a second LISN 2, which was bonded to the ground reference plane in the same way as the LISN 1 for the unit being measured. A multiple socket outlet strip was used to connect multiple power cables to a single LISN provided the rating of the LISN was not exceeded.
- 3) The table top EUT was placed upon a non-metallic table 0.8 m or 0.1 m above the ground reference plane. And for floor-standing arrangement, the EUT was placed on the horizontal ground reference plane.
- 4) The test was performed with a vertical ground reference plane. The rear of the EUT shall be 0.4 m from the vertical ground reference plane. The vertical ground reference plane was bonded to the horizontal ground reference plane. The LISN 1 was placed 0.8 m or 0.1 m from the boundary of the unit under test

Shenzhen UnionTrust Quality and Technology Co., Ltd.

Address: Unit D/E of 9/F and 16/F, Block A, Building 6, Baoneng science and technology park, Longhua district, Shenzhen, China

Tel: +86-755-28230888

Fax: +86-755-28230886

E-mail: info@uttlab.com

<http://www.uttlab.com>

UTTR-EMC-EN55032-V1.2

and bonded to a ground reference plane for LISNs mounted on top of the ground reference plane. This distance was between the closest points of the LISN 1 and the EUT. All other units of the EUT and associated equipment was at least 0.8 m from the LISN 2.

Equipment Used: Refer to section 3 for details.

Test Result: Pass

The worst measurement data as follows:

Quasi Peak and Average:

Test Mode 6

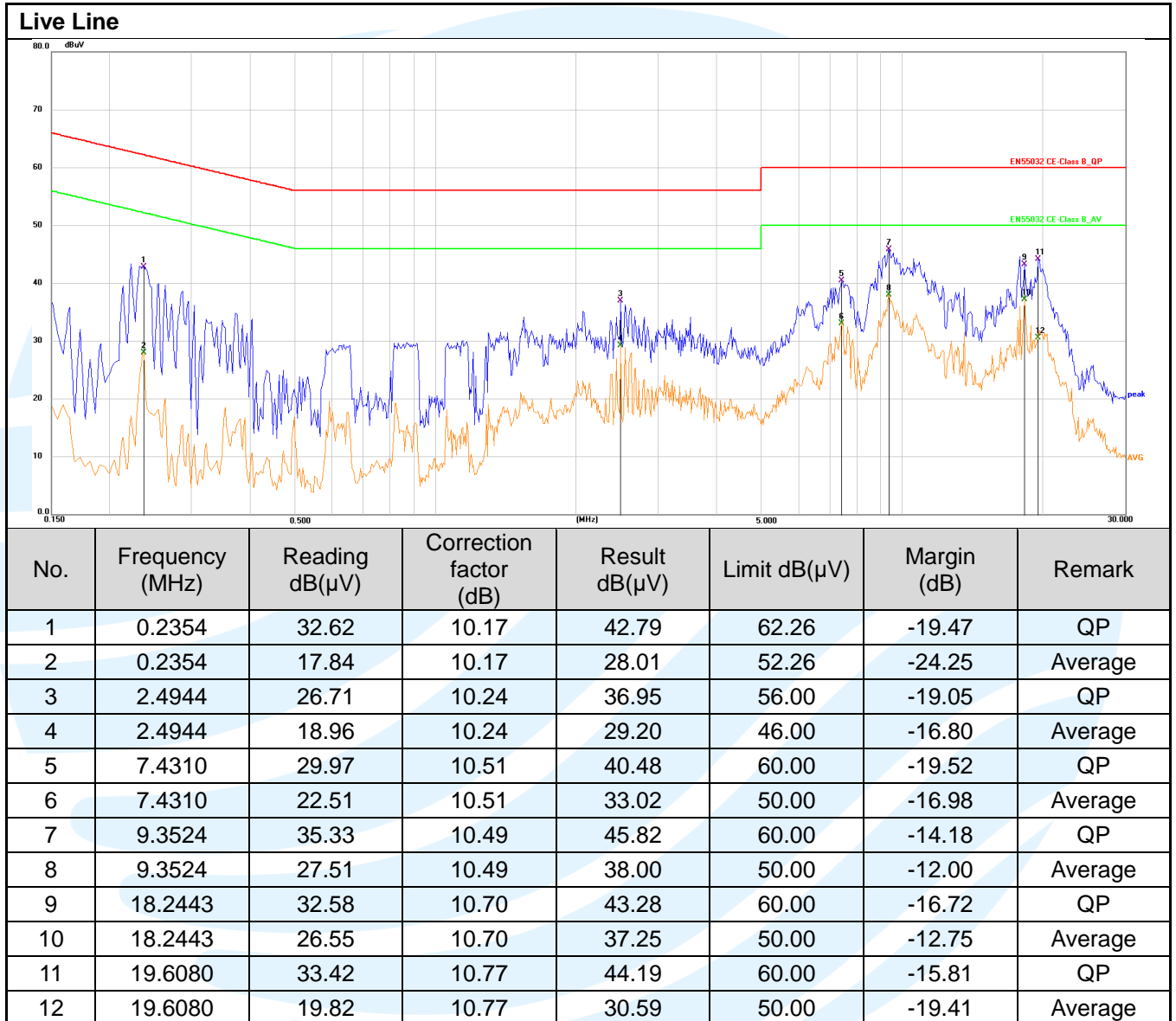

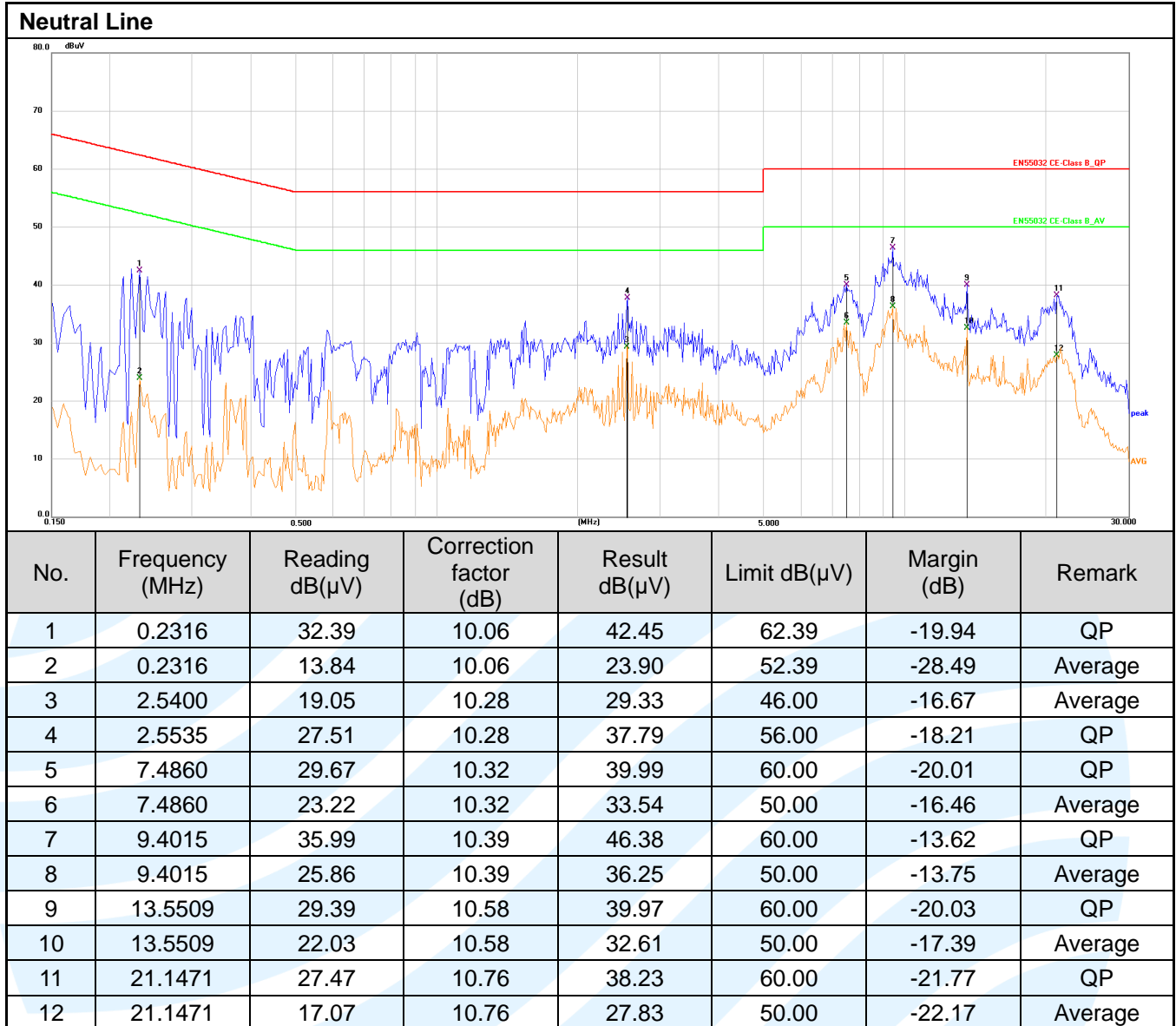

Remark:

1. Correct Factor = LISN Factor + Cable Loss + Pulse Limiter Factor, the value was added to Original Receiver Reading by the software automatically.
2. Result = Reading + Correct Factor.
3. Margin = Result - Limit
4. An initial pre-scan was performed on the Phase and neutral lines with peak detector. Quasi-Peak and Average measurement were performed at the frequencies with maximized peak emission were detected.
5. All possible modes of operation were investigated, and testing at two nominal voltages of 230V~50Hz and 110V~60Hz, only the worst case emissions reported.

6.2.3 Harmonic Current Emissions

Test Requirement: EN IEC 61000-3-2:2019/A1:2021 Clause 6.2.3

Test Method: The appropriate requirements of EN 61000-3-2/A1 for harmonic current emission apply for equipment covered by the scope of the present document with an input current up to and including 16A per phase. For equipment with an input current of greater than 16A per phase EN 61000-3-12 applies.

Test Setup:

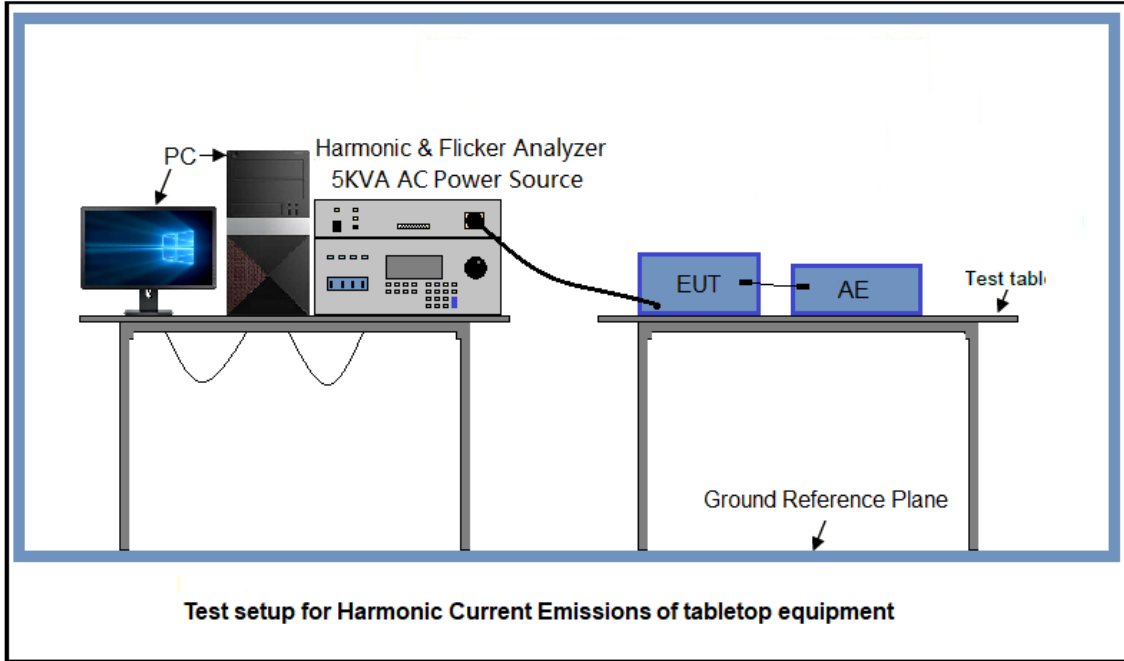

Equipment Used: Refer to section 3 for details.

There is no need for Harmonics test to be performed on this product (rated power is less than 75W) in accordance with EN 61000-3-2. For further details, please refer to Clause 7 of EN 61000-3-2 which states:

Test Result:

“For the following categories of equipment, limits are not specified in this standard.
 - equipment with a rated power of 75W or less, other than lighting equipment.”

The worst measurement data as follows:

Harmonics – Class-D per IEC 61000-3-2:2018/AMD1:2020(Run time)

EUT: Q27U3CV
 Test category: Class-D (European limits)
 Test date: 2023/12/8
 Test duration (min): 2.5
 Comment: TM6
 Customer: 2311178087

Tested by: Bowie
 Test Margin: 100
 End time: 7:55:41
 Data file name: H-000468.cts_data

Test Result: Pass Source qualification: Normal

Current & voltage waveforms

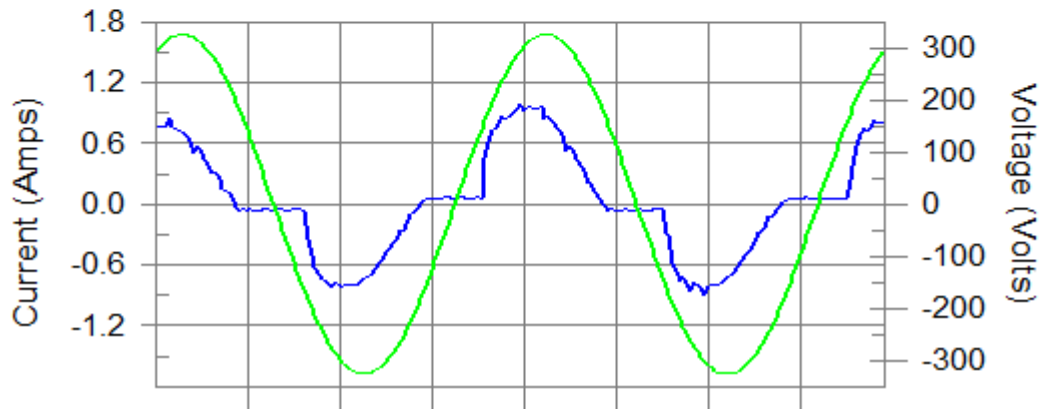

Harmonics and Class D limit line European Limits

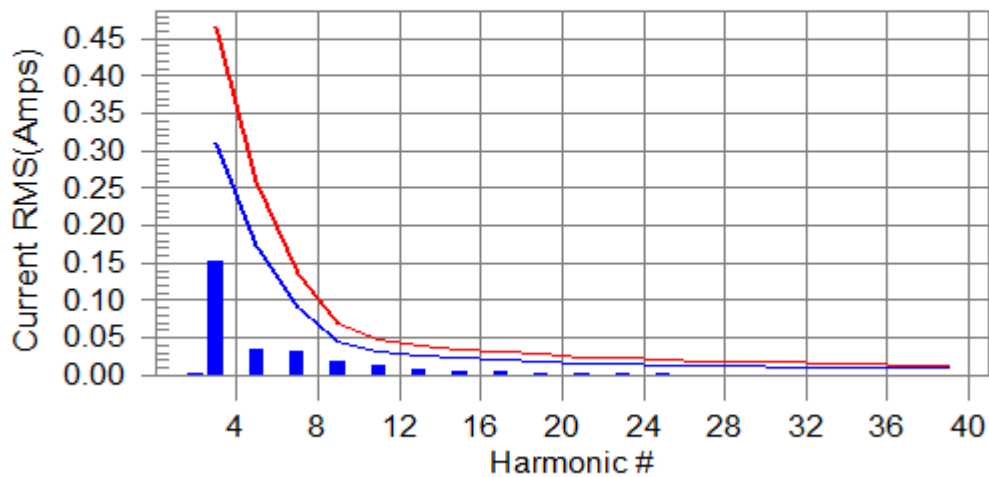

Test result: Pass Worst harmonics H11-38.4% of 150% limit, H3-48.9% of 100% limit

Current Test Result Summary (Run time)

EUT: Q27U3CV Tested by: Bowie
 Test category: Class-D (European limits) Test Margin: 100
 Test date: 2023/12/8 Start time: 7:53:00 End time: 7:55:41
 Test duration (min): 2.5 Data file name: H-000468.cts_data
 Comment: TM6
 Customer: 2311178087

Test Result: Pass Source qualification: Normal
 THC(A): 0.160 I-THD(%): 38.8 POHC(A): 0.004 POHC Limit(A): 0.039

Highest parameter values during test:

V_RMS (Volts): 230.40	Frequency(Hz): 50.00
I_Peak (Amps): 1.041	I_RMS (Amps): 0.493
I_Fund (Amps): 0.412	Crest Factor: 2.674
Power (Watts): 91.1	Power Factor: 0.893

Harm#	Harms(avg)	100%Limit	%of Limit	Harms(max)	150%Limit	%of Limit	Status
2	0.001	0.000	N/A	0.004	0.000	N/A	Pass
3	0.151	0.310	48.9	0.159	0.464	34.1	Pass
4	0.001	0.000	N/A	0.001	0.000	N/A	Pass
5	0.034	0.173	19.7	0.043	0.260	16.7	Pass
6	0.001	0.000	N/A	0.001	0.000	N/A	Pass
7	0.031	0.091	33.9	0.036	0.137	26.5	Pass
8	0.001	0.000	N/A	0.001	0.000	N/A	Pass
9	0.017	0.046	37.3	0.024	0.068	35.1	Pass
10	0.001	0.000	N/A	0.001	0.000	N/A	Pass
11	0.012	0.032	37.2	0.018	0.048	38.4	Pass
12	0.001	0.000	N/A	0.001	0.000	N/A	Pass
13	0.008	0.027	29.3	0.011	0.041	27.6	Pass
14	0.001	0.000	N/A	0.001	0.000	N/A	Pass
15	0.005	0.024	N/A	0.010	0.036	N/A	Pass
16	0.001	0.000	N/A	0.001	0.000	N/A	Pass
17	0.004	0.021	N/A	0.007	0.031	N/A	Pass
18	0.001	0.000	N/A	0.001	0.000	N/A	Pass
19	0.003	0.018	N/A	0.006	0.028	N/A	Pass
20	0.001	0.000	N/A	0.001	0.000	N/A	Pass
21	0.002	0.017	N/A	0.004	0.025	N/A	Pass
22	0.001	0.000	N/A	0.001	0.000	N/A	Pass
23	0.001	0.015	N/A	0.004	0.023	N/A	Pass
24	0.001	0.000	N/A	0.001	0.000	N/A	Pass
25	0.001	0.014	N/A	0.002	0.021	N/A	Pass
26	0.001	0.000	N/A	0.001	0.000	N/A	Pass
27	0.001	0.013	N/A	0.002	0.020	N/A	Pass
28	0.001	0.000	N/A	0.001	0.000	N/A	Pass
29	0.001	0.012	N/A	0.001	0.018	N/A	Pass
30	0.001	0.000	N/A	0.001	0.000	N/A	Pass
31	0.001	0.011	N/A	0.002	0.017	N/A	Pass
32	0.001	0.000	N/A	0.002	0.000	N/A	Pass
33	0.001	0.011	N/A	0.002	0.016	N/A	Pass
34	0.001	0.000	N/A	0.001	0.000	N/A	Pass
35	0.001	0.010	N/A	0.001	0.015	N/A	Pass
36	0.001	0.000	N/A	0.001	0.000	N/A	Pass
37	0.001	0.009	N/A	0.002	0.014	N/A	Pass
38	0.001	0.000	N/A	0.001	0.000	N/A	Pass
39	0.001	0.009	N/A	0.002	0.014	N/A	Pass
40	0.001	0.000	N/A	0.001	0.000	N/A	Pass

Voltage Source Verification Data (Run time)

EUT: Q27U3CV Tested by: Bowie
 Test category: Class-D (European limits) Test Margin: 100
 Test date: 2023/12/8 Start time: 7:53:00 End time: 7:55:41
 Test duration (min): 2.5 Data file name: H-000468.cts_data
 Comment: TM6
 Customer: 2311178087

Test Result: Pass Source qualification: Normal

Highest parameter values during test:

Voltage (Vrms): 230.40	Frequency(Hz): 50.00
I_Peak (Amps): 1.041	I_RMS (Amps): 0.493
I_Fund (Amps): 0.412	Crest Factor: 2.674
Power (Watts): 91.1	Power Factor: 0.893

Harm#	Harmonics V-rms	Limit V-rms	% of Limit	Status
2	0.141	0.461	30.62	OK
3	0.643	2.074	31.03	OK
4	0.093	0.461	20.11	OK
5	0.032	0.922	3.52	OK
6	0.045	0.461	9.67	OK
7	0.033	0.691	4.79	OK
8	0.042	0.461	9.11	OK
9	0.029	0.461	6.31	OK
10	0.021	0.461	4.53	OK
11	0.020	0.230	8.61	OK
12	0.028	0.230	12.33	OK
13	0.018	0.230	7.70	OK
14	0.012	0.230	5.06	OK
15	0.013	0.230	5.68	OK
16	0.026	0.230	11.12	OK
17	0.012	0.230	5.24	OK
18	0.027	0.230	11.88	OK
19	0.006	0.230	2.56	OK
20	0.022	0.230	9.39	OK
21	0.010	0.230	4.33	OK
22	0.012	0.230	5.20	OK
23	0.009	0.230	3.81	OK
24	0.009	0.230	3.91	OK
25	0.008	0.230	3.54	OK
26	0.009	0.230	3.71	OK
27	0.007	0.230	3.01	OK
28	0.007	0.230	2.90	OK
29	0.006	0.230	2.82	OK
30	0.007	0.230	3.14	OK
31	0.005	0.230	2.32	OK
32	0.009	0.230	3.95	OK
33	0.007	0.230	3.16	OK
34	0.004	0.230	1.77	OK
35	0.004	0.230	1.92	OK
36	0.004	0.230	1.90	OK
37	0.006	0.230	2.67	OK
38	0.003	0.230	1.43	OK
39	0.004	0.230	1.70	OK
40	0.007	0.230	3.10	OK

6.2.4 Voltage Fluctuations and Flicker

Test Requirement: EN 61000-3-3:2013/A2:2021 Clause 4

Test Method: The appropriate requirements of EN 61000-3-3 for voltage fluctuations and flicker apply for equipment covered by the scope of the present document with an input current up to and including 16A per phase, if no conditional connection is needed. Where a conditional connection is required then the requirements of EN 61000-3-11 [12] shall apply.
For equipment with an input current of greater than 16A up to and including 75A per phase EN 61000-3-11 applies.

Test Setup:

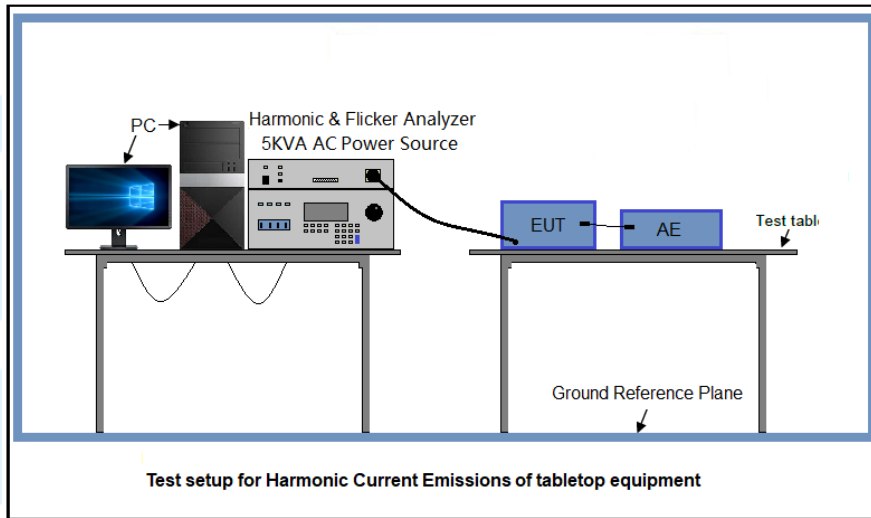

Equipment Used: Refer to section 3 for details.

Test Result: Pass

The worst measurement data as follows:

Flicker Test Summary per EN/IEC61000-3-3 Ed. 3.0 (2013) (Run time)

	Result	Test Limit
dt > 3.3 % (ms)	0	500.0
dc (%)	0.00	3.30
dmax (%)	0.00	4.00
Pst (10 min. period)	0.291	1.000
Pit (2 hr. period)	N/A	0.650

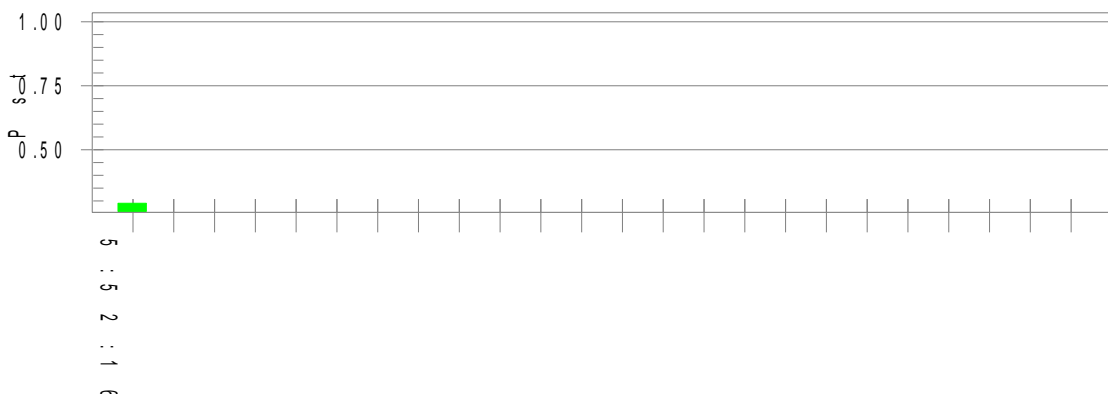

6.2.5 Conducted Emission (Asymmetric mode conducted emissions & conducted differential voltage emissions)

Test Requirement: EN 55032:2015/A11:2020 Clause 5

Test Method: EN 55032:2015/A11:2020 Clause 6

Limit:

Class A

Table A.11 – Requirements for asymmetric mode conducted emissions from Class A equipment

Table clause	Frequency range (MHz)	Coupling device (see Table A.8)	Detector type / bandwidth	Class A voltage limits dB(μV)	Class A current limits dB(μA)
A11.1	0.15 to 0.5	AAN	Quasi Peak / 9 kHz	97 to 87	N/A
	0.5 to 30			87	
	0.15 to 0.5	AAN	Average / 9 kHz	84 to 74	
	0.5 to 30			74	
A11.2	0.15 to 0.5	CVP and current probe	Quasi Peak / 9 kHz	97 to 87	53 to 43
	0.5 to 30			87	43
	0.15 to 0.5	CVP and current probe	Average / 9 kHz	84 to 74	40 to 30
	0.5 to 30			74	30
A11.3	0.15 to 0.5	Current Probe	Quasi Peak / 9 kHz	N/A	53 to 43
	0.5 to 30				43
	0.15 to 0.5	Current Probe	Average / 9 kHz		40 to 30
	0.5 to 30				30

The choice of coupling device and measurement procedure is defined in Annex C.
 AC mains ports that also have the function of a wired network port shall meet the limits given in Table A.9.
 The measurement shall cover the entire frequency range.
 The application of the voltage and/or current limits is dependent on the measurement procedure used.
 Refer to Table C.1 for applicability.
 Testing is required at only one EUT supply voltage and frequency.
 Applicable to ports listed above and intended to connect to cables longer than 3 m.

Class B

Table A.12 – Requirements for asymmetric mode conducted emissions from Class B equipment

Table clause	Frequency range (MHz)	Coupling device (see Table A.8)	Detector type / bandwidth	Class B voltage limits dB(μV)	Class B current limits dB(μA)
A12.1	0.15 to 0.5	AAN	Quasi Peak / 9 kHz	84 to 74	N/A
	0.5 to 30			74	
	0.15 to 0.5	AAN	Average / 9 kHz	74 to 64	
	0.5 to 30			64	
A12.2	0.15 to 0.5	CVP and current probe	Quasi Peak / 9 kHz	84 to 74	40 to 30
	0.5 to 30			74	30
	0.15 to 0.5	CVP and current probe	Average / 9 kHz	74 to 64	30 to 20
	0.5 to 30			64	20
A12.3	0.15 to 0.5	Current Probe	Quasi Peak / 9 kHz	N/A	40 to 30
	0.5 to 30				30
	0.15 to 0.5	Current Probe	Average / 9 kHz		30 to 20
	0.5 to 30				20

The choice of coupling device and measurement procedure is defined in Annex C.
 Screened ports including TV broadcast receiver tuner ports are measured with a common-mode impedance of 150 Ω. This is typically accomplished with the screen terminated by 150 Ω to earth.
 AC mains ports that also have the function of a wired network port shall meet the limits given in Table A.10.

Shenzhen UnionTrust Quality and Technology Co., Ltd.

Address: Unit D/E of 9/F and 16/F, Block A, Building 6, Baoneng science and technology park, Longhua district, Shenzhen, China

Tel: +86-755-28230888

Fax: +86-755-28230886

E-mail: info@uttlab.com

<http://www.uttlab.com>

UTTR-EMC-EN55032-V1.2

The measurement shall cover the entire frequency range.
 The application of the voltage and/or current limits is dependent on the measurement procedure used.
 Refer to Table C.1 for applicability.
 Measurement is required at only one EUT supply voltage and frequency.
 Applicable to ports listed above and intended to connect to cables longer than 3 m.

Table A.13 – Requirements for conducted differential voltage emissions from Class B equipment

Table clause	Frequency range (MHz)	Detector type/ bandwidth	Class B limits dB(mV) 75 Ω			Applicability
			Other	Local Oscillator Fundamental	Local Oscillator Harmonics	
A13.1	30 to 950	For frequencies ≤1 GHz	46	46	46	See ^a
	950 to 2 150		46	54	54	
A13.2	950 to 2 150	Quasi Peak/ 120 kHz	46	54	54	See ^b
A13.3	30 to 300		For frequencies ≥1 GHz	46	54	50
	300 to 1 000	52				
A13.4	30 to 300	For frequencies ≥1 GHz	46	66	59	See ^d
	300 to 1 000				52	
A13.5	30 to 950	Peak/ 1 MHz	46	76	46	See ^e
	950 to 2 150			n/a	54	

- Television receivers (analogue or digital), video recorders and PC TV broadcast receiver tuner cards working in channels between 30 MHz and 1 GHz, and digital audio receivers.
 - Tuner units (not the LNB) for satellite signal reception.
 - Frequency modulation audio receivers and PC tuner cards.
 - Frequency modulation car radios.
 - Applicable to EUTs with RF modulator output ports (for example DVD equipment, video recorders, camcorders and decoders etc.) designed to connect to TV broadcast receiver tuner ports. Limits specified for the LO are for the RF modulator carrier signal and harmonics.
- The term 'other' refers to all emissions other than the fundamental and the harmonics of the LO.
 The measurement shall cover the entire frequency range.
 The EUT shall be tuned in accordance with Table B.3 and clause C.4.2.1.

Test Setup:

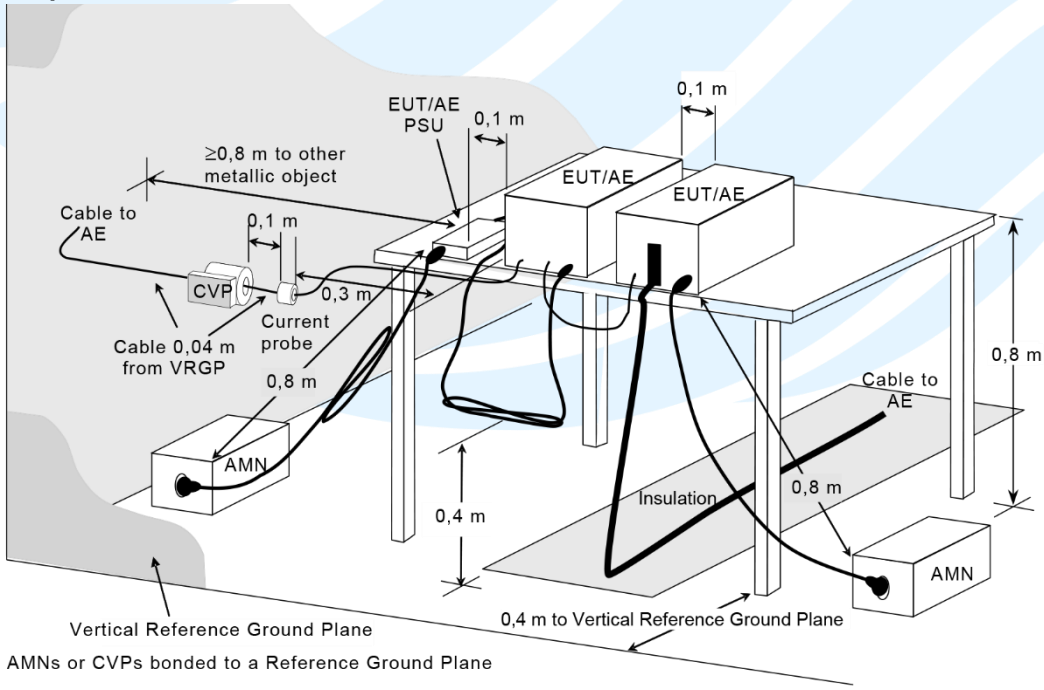

IEC

Shenzhen UnionTrust Quality and Technology Co., Ltd.

Address: Unit D/E of 9/F and 16/F, Block A, Building 6, Baoneng science and technology park, Longhua district, Shenzhen, China
 Tel: +86-755-28230888 Fax: +86-755-28230886 E-mail: info@uttlab.com <http://www.uttlab.com>
 UTR-EMC-EN55032-V1.2

Test Procedures:

- 1) The mains terminal disturbance voltage test was conducted in a shielded room.
- 2) The setup is the same as conduction besides this, connecting between AE and telecommunication port through ISN.
- 3) The tabletop EUT was placed upon a non-metallic table 0.8m above the ground reference plane. And for floor-standing arrangement, the EUT was placed on the horizontal ground reference plane,
- 4) The test was performed with a vertical ground reference plane. The rear of the EUT shall be 0.4 m from the vertical ground reference plane. The vertical ground reference plane was bonded to the horizontal ground reference plane. The ISN was placed 0.8 m from the boundary of the unit under test and bonded to a ground reference plane for ISN mounted on top of the ground reference plane. This distance was between the closest points of the ISN and the EUT. All other units of the EUT and associated equipment was at least 0.8 m from the LISN.

Equipment Used: Refer to section 3 for details.

Test Result: Pass

The worst measurement data as follows:

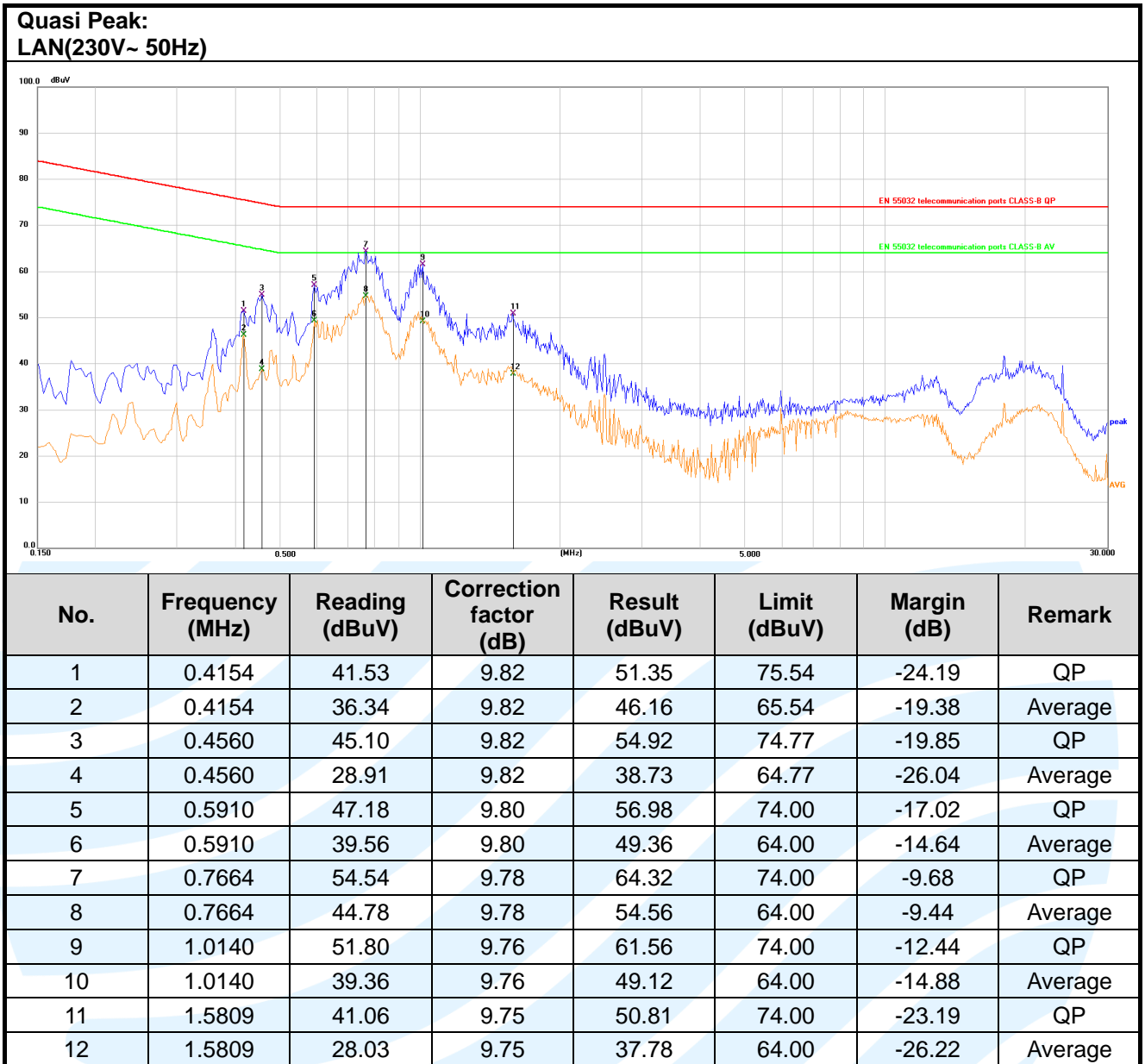

Remark:

1. Result = Reading + Correct Factor.
2. Margin = Result - Limit
3. An initial pre-scan was performed on the Phase and neutral lines with peak detector. Quasi-Peak and Average measurement were performed at the frequencies with maximized peak emission were detected.
4. All possible modes of operation were investigated.
5. Testing at two nominal voltages of 230V~ 50Hz and 120V~ 60Hz.
Only the worst case emissions reported.

Shenzhen UnionTrust Quality and Technology Co., Ltd.

Address: Unit D/E of 9/F and 16/F, Block A, Building 6, Baoneng science and technology park, Longhua district, Shenzhen, China

Tel: +86-755-28230888

Fax: +86-755-28230886

E-mail: info@uttlab.com

<http://www.uttlab.com>

UTTR-EMC-EN55032-V1.2

6.3 IMMUNITY (ENCLOSURE PORTS)

6.3.1 RF electromagnetic field

- Test Requirement:** EN 55035:2017/A11:2020 Table Clause 1.2, Table Clause 1.3
- Test Method:** The test method shall be in accordance with EN 61000-4-3
- Criterion Required:** performance criteria A
- Frequency range:** swept test: 80 MHz to 1 000 MHz
spot test: 1 800 MHz, 2 600 MHz, 3 500 MHz, 5 000 MHz
- Test Level:** Level 2: 3 V/m(measured unmodulated)
- Modulation:** 1 kHz Sine wave, 80 % Amp. Modulation, audio signal of 400 Hz
- Frequency Step:** 1 % increment
- Dwell time:** 1 seconds
- Polarity Antenna:** Horizontal and vertical

Test Setup:

Test setup for Continuous RF electromagnetic field disturbances, swept test and spot test of tabletop equipment

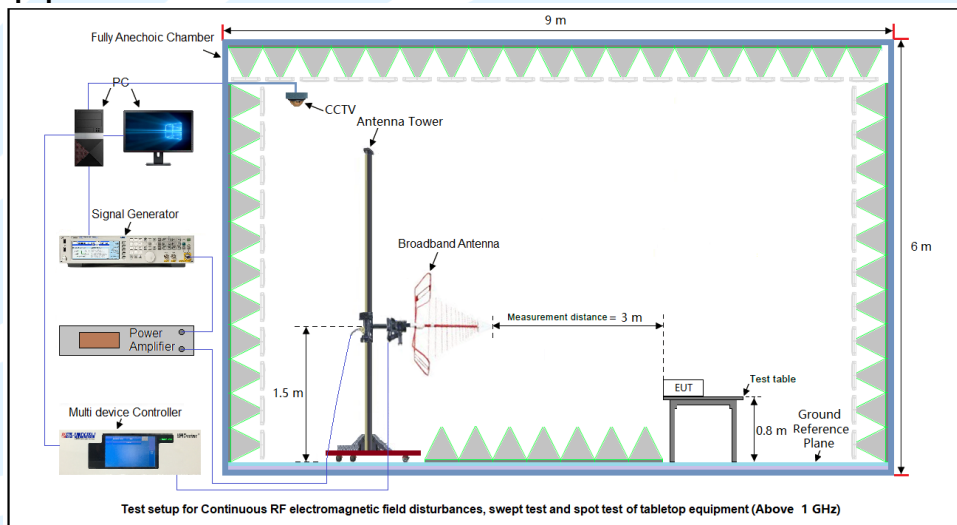

Figure 1. 30 MHz to 1 GHz

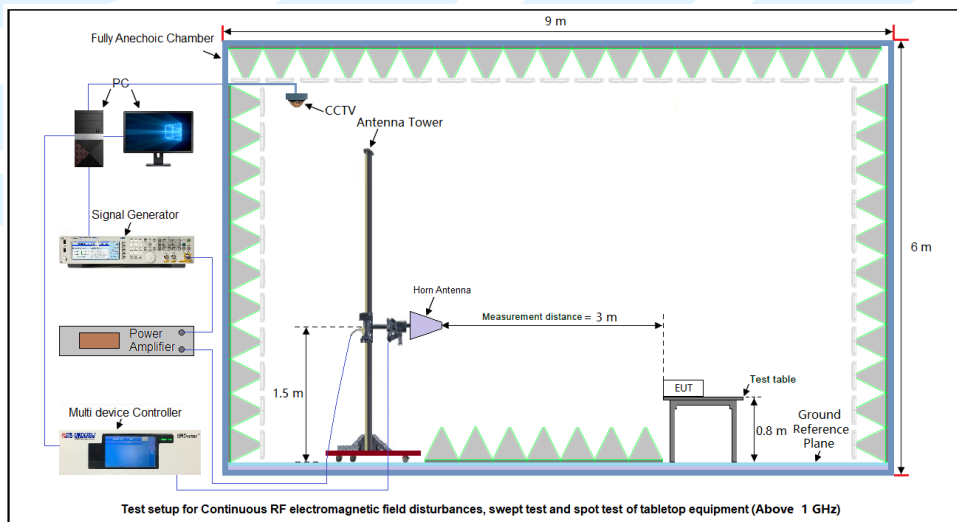
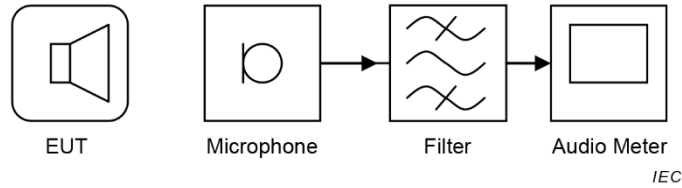

Figure 2. Above 1 GHz

Test setup for acoustic measurements



Test Procedures:

- 1) For table-top equipment, the EUT was placed in the chamber on a non-conductive table 0.8m high. For arrangement of floor-standing equipment, the EUT was mounted on a non-conductive support 0.1m above the supporting plane. For human body-mounted equipment, the EUT may be tested in the same manner as table top items.
- 2) If possible, a minimum of 1 m of cable is exposed to the electromagnetic field. Excess length of cables interconnecting units of the EUT shall be bundled low-inductively in the approximate center of the cable to form a bundle 30 cm to 40 cm in length.
- 3) The EUT was initially placed with one face coincident with the calibration plane. The EUT face being illuminated was contained within the UFA (Uniform Field Area).
- 4) The frequency ranges to be considered were swept with the signal modulated and pausing to adjust the RF signal level or to switch oscillators and antennas as necessary. Where the frequency range was swept incrementally, the step size was not exceed 10 % of the preceding frequency value.
- 5) The dwell time of the amplitude modulated carrier at each frequency was not be less than the time necessary for the EUT to be exercised and to respond, and was not less than 0.5 s.
- 6) The test normally was performed with the generating antenna facing each side of the EUT.
- 7) The polarization of the field generated by each antenna necessitates testing each selected side twice, once with the antenna positioned vertically and again with the antenna positioned horizontally.
- 8) The EUT was performed in a configuration to actual installation conditions, a video camera and/or an audio monitor were used to monitor the performance of the EUT.

Equipment Used: Refer to section 3 for details.

Test Result: See below table.

EUT Face	Frequency	Level	Result (Pursuant to EN 55035 Criterion A)
Front	Swept test: 80 MHz to 1 000 MHz Spot test: 1.8 GHz, 2.6 GHz, 3.5 GHz, 5.0 GHz	3 V/m	A
Back			A
Left			A
Right			A
Top			A
Under			A

Observation:

- No observable change.
- The audio output signal level was monitored during test and was found to be at least 20dB less than the reference level recorded before the start of the test.

Conclusion: The EUT met the requirements of the standard.

6.3.2 Electrostatic Discharge

Test Requirement:	EN 55035:2017/A11:2020 Table Clause 1.4
Test Method:	The test method shall be in accordance with EN 61000-4-2
Criterion Required:	performance criteria B
Discharge Impedance:	330 Ω / 150 pF
Polarity:	Positive & Negative
Number of Discharge:	Minimum 10 times at each test point
Discharge Mode:	Single Discharge
Discharge Period:	1 second minimum
Test Level:	Contact discharge: Level 2, ±4 kV Air discharge: Level 3, ±8 kV

Test Setup:

Test set-up for table-top equipment

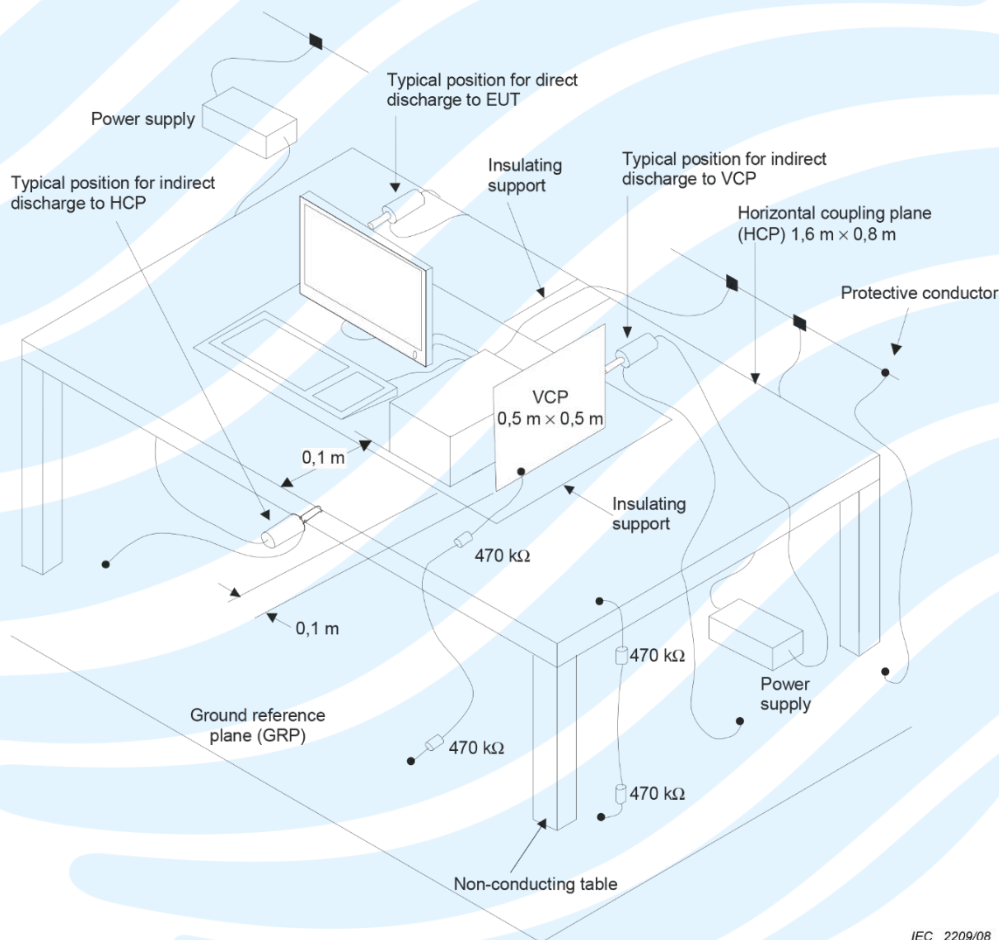

IEC 2209/08

Test Procedures:

- 1) Electrostatic discharges shall be applied only to points and surfaces of the EUT which are expected to be touched during normal operation, including user access operations specified in the user manual, for example cleaning or adding consumables when the EUT is powered. The application of discharges to the contacts of open connectors is not required.
When applying direct discharges to a portable or handheld battery- powered EUT with a display screen, it may not be possible to observe the screen for a given EUT orientation. If observation of the screen is necessary during this test, the EUT may be mounted vertically using non - metallic supports.
- 2) The EUT was put on a 0.8m high wooden table for table-top equipment or 0.1m high for floor standing equipment standing on the ground reference plane (GRP).

Shenzhen UnionTrust Quality and Technology Co., Ltd.

Address: Unit D/E of 9/F and 16/F, Block A, Building 6, Baoneng science and technology park, Longhua district, Shenzhen, China

Tel: +86-755-28230888

Fax: +86-755-28230886

E-mail: info@uttlab.com

<http://www.uttlab.com>

UTTR-EMC-EN55032-V1.2

- 3) A horizontal coupling plane(HCP) 1.6m by 0.8m in size was placed on the table, and the EUT with its cables were isolated from the HCP by an insulating support thick than 0.5mm. The VCP 0.5m by 0.5m in size & HCP were constructed from the same material type & think mess as that of the GRP, and connected to the GRP via a 470kΩ resistor at each end. The distance between EUT and any of the other metallic surface excepted the GRP, HCP and VCP was greater than 1m.
- 4) During the contact discharges, the tip of the discharge electrode was touch the EUT before the discharge switch is operated. During the air discharges, the round discharge tip of the discharge electrode was approached as fast as possible to touch the EUT.
- 5) After each discharge, the ESD generator was removed from the EUT, the generator was then retrigged for a new single discharge. For ungrounded product, a discharge cable with two resistances was used after each discharge to remove remnant electrostatic voltage. 10 times of each polarity single discharge were applied to HCP and VCP.

Equipment Used: Refer to section 3 for details.

Test Result: See below table.

Discharge Type	Applied Voltage	Pulse No.	Result (Pursuant to EN55035 Criterion B)		
			A	B (see phenomena)	N/A
Contact Discharge	± 4 kV	10 for every level	<input type="checkbox"/> A	<input checked="" type="checkbox"/> B (see phenomena)	<input type="checkbox"/> N/A
Air Discharge	± 8 kV	10 for every level	<input type="checkbox"/> A	<input checked="" type="checkbox"/> B (see phenomena)	<input type="checkbox"/> N/A
Indirect HCP Discharge	± 4 kV	10 for every level	<input checked="" type="checkbox"/> A	<input type="checkbox"/> B (see phenomena)	<input type="checkbox"/> N/A
Indirect VCP Discharge	± 4 kV	10 for every level	<input checked="" type="checkbox"/> A	<input type="checkbox"/> B (see phenomena)	<input type="checkbox"/> N/A

Remark:

N/A: Not applicable

Observation:

No observable change.

During the experiment, the following phenomena occurred:

1. During the test, Air Discharge on the Screen edge, the EUT screen flashes. After the test is automatically restored.
2. During the test, Contact Discharge on the USB Type-A Port and Type-C Port, the EUT screen flashes. After the test is automatically restored.

Conclusion: The EUT met the requirements of the standard.

6.3.3 Power frequency magnetic field

- Test Requirement:** EN 55035:2017/A11:2020 Table Clause 1.1
- Test Method:** The test method shall be in accordance with IEC 61000-4-8
- Criterion Required:** A
- Frequency:** 50 or 60
- Test Level:** Level 2: 1 A/m (rms)
- Test Setup:**

Test setup for floor-standing equipment

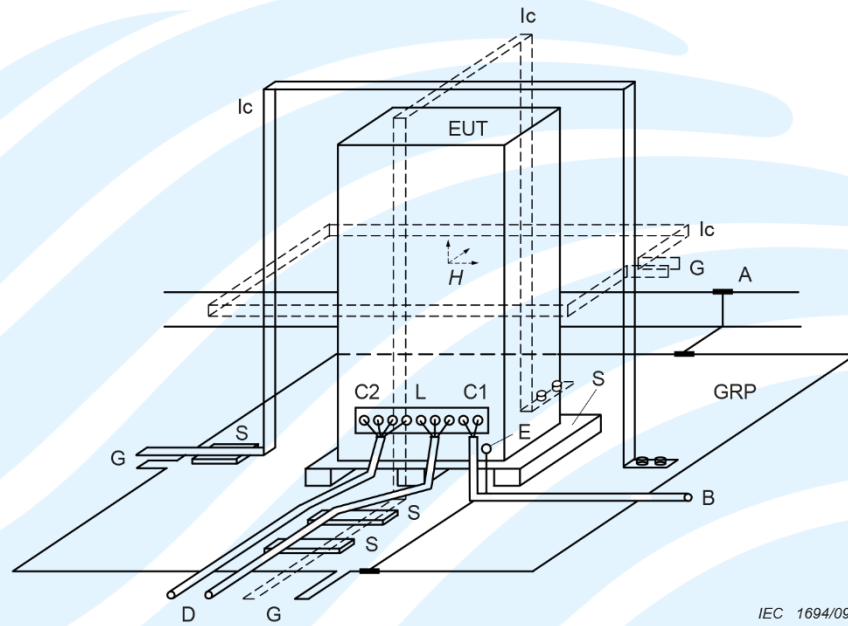

IEC 1694/09

Components

- | | | | |
|-----|----------------------|----|-----------------------------|
| GRP | Ground plane | C1 | Power supply circuit |
| A | Safety earth | C2 | Signal circuit |
| S | Insulating support | L | Communication line |
| EUT | Equipment under test | B | To power supply source |
| Ic | Inductive coil | D | To signal source, simulator |
| E | Earth terminal | G | To the test generator |

Test set-up for table-top equipment

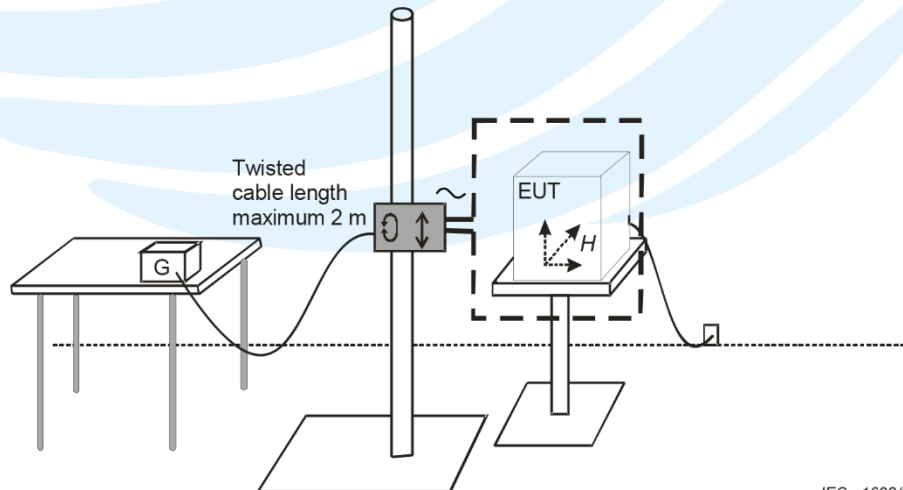

IEC 1692/09

Shenzhen UnionTrust Quality and Technology Co., Ltd.

Address: Unit D/E of 9/F and 16/F, Block A, Building 6, Baoneng science and technology park, Longhua district, Shenzhen, China

Tel: +86-755-28230888

Fax: +86-755-28230886

E-mail: info@uttlab.com

<http://www.uttlab.com>

UTTR-EMC-EN55032-V1.2

Test Procedures:

- 1) The Product and support units were located on a table, 0.8m away from ground floor.
- 2) The Product is configured and connected to satisfy its functional requirements. It shall be place on the GRP with the interposition of a 0.1m thickness insulating support (e.g. dry wood)
- 3) Setting the parameter of tests and then perform the test software of test simulator.
- 4) The induction coil shall enclose the Product placed at its centre.

Equipment Used: Refer to section 3 for details.

Test Result: See below table.

Direction	Field Strength (A/m)	Duration (Min)	Result (Pursuant to EN55035 Criterion A)
X axis	1	1	A
Y axis	1	1	A
Z axis	1	1	A

Observation: No observable change.

Conclusion: The EUT met the requirements of the standard.

Remark: The testing of Power frequency magnetic field was performed in GRG Metrology & Test Group Co., Ltd.

6.4 IMMUNITY (AC MAINS POWER PORTS)

6.4.1 Electrical fast transients/burst

- Test Requirement:** EN 55035:2017/A11:2020 Table Clause 4.5
- Test Method:** The test method shall be in accordance with EN 61000-4-4
- Criterion Required:** performance criteria B
- Test Port :** AC mains power port
- Polarity:** Positive & Negative
- Test Level and Repetition Frequency:**

- The test level for AC mains power input ports shall be 1 kV (Test Level: 2) open circuit voltage at a repetition rate of 5 kHz as given EN 61000-4-4.

- Impulse Wave shape:** 5/50 ns
- Burst Duration:** 15ms
- Burst Period:** 300ms
- Test Duration:** 2 minute per level & polarity
- Test Setup:**

Test set-up for table-top equipment

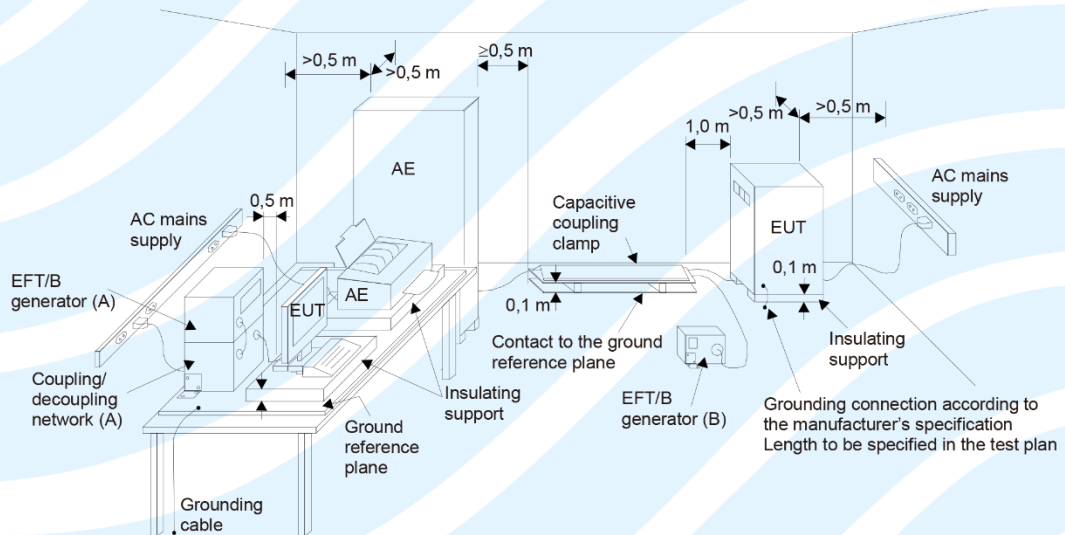

IEC 645/12

- (A) location for supply line coupling
- (B) location for signal lines coupling

Test Procedures:

- 1) The EUT was placed on a ground reference plane (GRP) insulated by an insulating support 0.1m thick and the GRP was placed on a 0.8m high wooden table for table-top equipment. For floor standing equipment, the EUT was placed on a 0.1m high wooden support above the GRP.
- 2) The GRP shall project beyond the EUT and the clamp by at least 0.1m on all sides. The distance between the EUT and any other of the metallic surface except the GRP was greater than 0.5m. All cables to the EUT was placed on the insulation support 0.1m above GRP. A cable not subject to EFT was routed as far as possible from cable under test to minimize the coupling between the cables.
- 3) The length of signal and power cable between the EUT and EFT generator was 0.5m. If the cable is a non-detachable supply cable more than 0.5m, the excess length of this cable shall be folded to avoid a flat coil and situated at a distance of 0.1m above the GRP.
- 4) The EUT was conducted the below specified test voltages for line and neutral or line, neutral and earth simultaneously (for Wired network, single, control and DC port line with capacitive coupling clamp), 120 seconds duration. If the equipment contains identical ports, only one was tested; multicomputer cables, such as a 50-pair Wired network cable, were tested as a single cable. Cables did not be split or divided into groups of conductors for this test; interface ports, which were intended by the manufacturer to be connected to data cables not longer than 3 m, did not be tested.

Equipment Used: Refer to section 3 for details.

Test Result: See below table.

Test Ports	Test Level	Result (Pursuant to EN 55035 Criterion B)	
AC mains power ports	± 0.5 kV, ± 1.0 kV	<input checked="" type="checkbox"/> A	<input type="checkbox"/> B (see phenomena)
Observation: <input checked="" type="checkbox"/> No observable change. <input type="checkbox"/> During the experiment, the following phenomena occurred:			
Conclusion: The EUT met the requirements of the standard.			

6.4.2 Continuous induced RF disturbances

- Test Requirement:** EN 55035:2017/A11:2020 Table Clause 4.1
- Test Method:** The test method shall be in accordance with EN 61000-4-6
- Criterion Required:** performance criteria A
 - 0.15 MHz to 10 MHz: 3 V (r.m.s)
 - 10 MHz to 30 MHz: 3 to 1 V (r.m.s)
 - 30 MHz to 80 MHz: 1 V (r.m.s)
- Test Level:**
- Modulation:** 80%, 1kHz Amplitude Modulation
- Step Size:** 1% increment
- Dwell Time:** 1s
- Test Setup:**

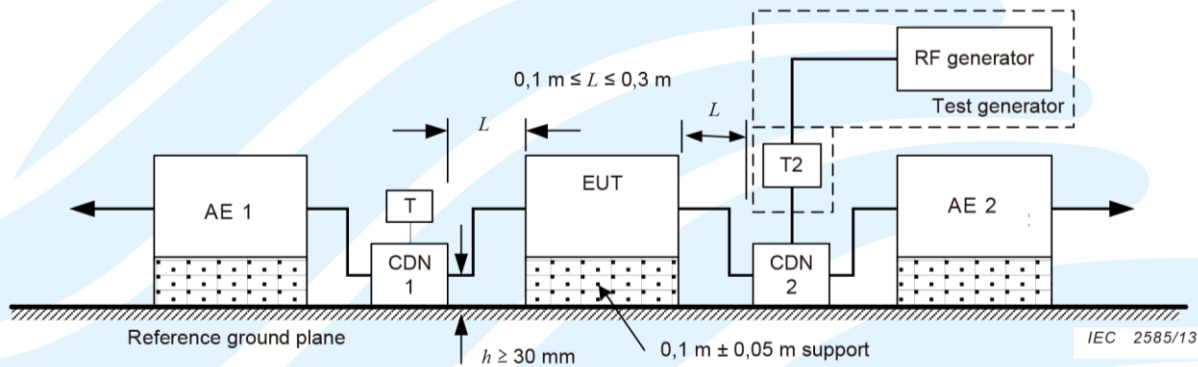

Schematic setup for immunity test used for CDN

Test setup for acoustic measurements

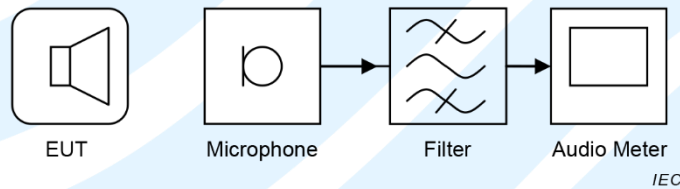

Test Procedures:

- 1) The Product and support units were located at a ground reference plane with the interposition of a 0.1 m thickness insulating support and the CDN was located on GRP directly.
- 2) The frequency range is swept from 150 kHz to 80MHz, with the signal 80% amplitude modulated with a 1 kHz sine wave. The rate of sweep did not exceed 1.5×10^{-3} decade/s. Where the frequency range is swept incrementally, the step size was 1% of fundamental.
- 1) The dwell time at each frequency shall be not less than the time necessary for the Product to be able to respond.

Equipment Used: Refer to section 3 for details.

Test Result: See below table.

Test Ports	Frequency	Test Level	Result (Pursuant to EN 55035 Criterion A)
AC mains power ports	0.15 MHz to 10 MHz	3 V	A
	10 MHz to 30 MHz	3 to 1 V	A
	30 MHz to 80 MHz	1 V	A

Observation:
 No observable change.
 The audio output signal level was monitored during test and was found to be at least 20dB less than the reference level recorded before the start of the test.

Conclusion: The EUT met the requirements of the standard.

6.4.3 Voltage dips and Voltage interruptions

Test Requirement: EN 55035:2017/A11:2020 Table Clause 4.2/ 4.3
Test Method: The test method shall be in accordance with EN 61000-4-11
Criterion Required:

Voltage dips	performance criteria B or C
interruptions	performance criteria C

Test Port : AC mains power port
 >95 % reduction: 0,5 period
Test Level: >30 % reduction: 25 period for 50Hz / 30 period for 60Hz
 >95 % reduction: 250 period for 50Hz / 300 period for 60Hz
No. of Dips / Interruptions: 3 per Level
Interval between Event: Minimum 10 seconds
Phase Angle: 0°/45°/90°/135°/180°/225°/270°/315°
Test Setup:

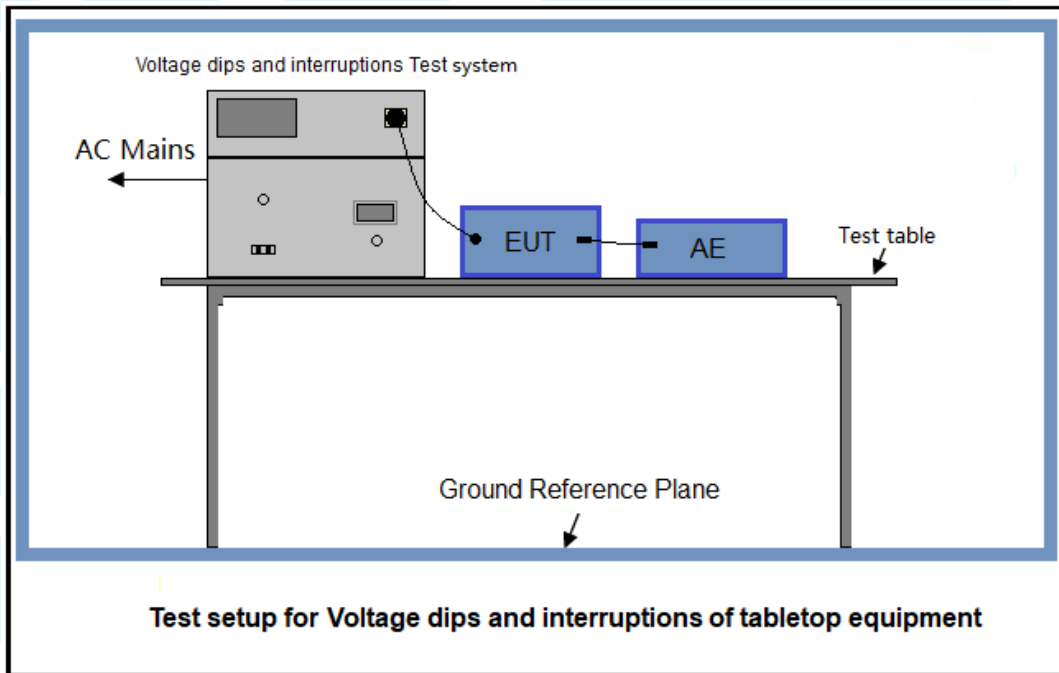

Test Procedures:

- 1) The EUT was placed on a ground reference plane (GRP) insulated by an insulating support 0.1 m thick and the GRP was placed on a 0.8m high wooden table for table-top equipment. For floor standing equipment, the EUT was placed on a 0.1m high wooden support above the GRP.
- 2) The test was performed with the EUT connected to the test generator with the shortest power supply cable as specified by the EUT manufacturer.
- 3) The EUT was tested for each selected combination of test level and duration with a sequence of three dips /interruptions with intervals of 10 s minimum. Each representative mode of operation was tested.
- 4) For EUT with more than one power cord, each power cord was tested individually.

Equipment Used: Refer to section 3 for details.

Test Result: See below table.

Test Condition		Result (Pursuant to EN 55035 Criterion B or C)			
Test Level in %UT	Period	Meet Criterion B		Meet Criterion C	
0	0.5	<input checked="" type="checkbox"/> A	<input type="checkbox"/> B (see phenomena)	N/A	
70	25 for 50 Hz 30 for 60 Hz	N/A		<input checked="" type="checkbox"/> A	<input type="checkbox"/> B (see phenomena) <input type="checkbox"/> C(see phenomena)
0	250 for 50 Hz 300 for 60 Hz	N/A		<input type="checkbox"/> A	<input checked="" type="checkbox"/> B (see phenomena) <input type="checkbox"/> C(see phenomena)

Remark:

N/A: Not applicable

Observation:

No observable change.

During the experiment, the following phenomena occurred:

The EUT turned off at 0%UT test level with 250 cycles (at 50Hz) duration and it could auto resume to normal after the test.

Conclusion: The EUT met the requirements of the standard.

6.4.4 Surges

Test Requirement:	EN 55035:2017/A11:2020 Table Clause 4.4
Test Method:	The test method shall be in accordance with EN 61000-4-5
Criterion Required:	performance criteria B
Wave Shape:	for AC mains power and DC network power ports 1.2/50 (8/20) μ s
Test Level:	for AC mains power ports: 2 kV line to ground, and 1 kV line to line
Polarity:	Positive & Negative
Interval:	60s between each surge
No. of Surges:	5 positive at 90°, 5 negative at 270°
Test Setup:	

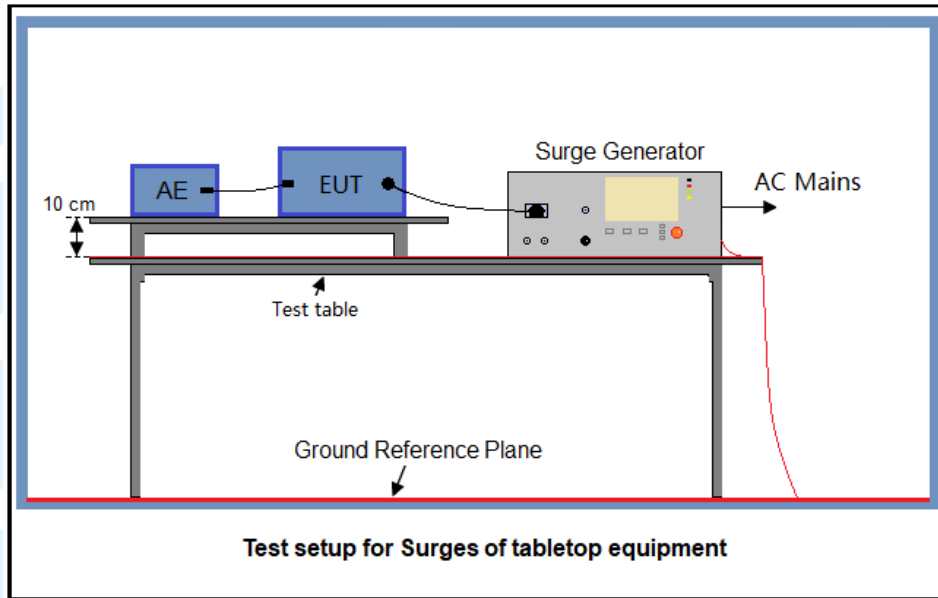

Figure 1. For AC port

Test Procedures:

Test Procedure:

- 1) The EUT was placed on a ground reference plane (GRP) insulated by an insulating support 0.1 m thick and the GRP was placed on a 0.8m high wooden table for table-top equipment. For floor standing equipment, the EUT was placed on a 0.1m high wooden support above the GRP.
- 2) The 1.2/50 μ s surge was to be applied to the EUT power supply terminals via the capacitive coupling network. Decoupling networks were required in order to avoid possible adverse effects on equipment not under test that may be powered by the same lines and to provide sufficient decoupling impedance to the surge wave so that the specified wave may be applied on the lines under test.
- 3) The power cord between the EUT and the coupling/decoupling network was not exceed 2 m in length. The interconnection line between the EUT and the coupling/decoupling network shall not exceed 2 m in length.
- 4) The EUT was conducted 0.5 kV and 1 kV test voltage for line to line and line to neutral and conducted 0.5 kV, 1 kV and 2 kV test voltage for line to earth and neutral to earth, five positive pulses and five negative pulses each at 90°, 270° for a.c. power ports and five positive pulses and five negative surge pulses for d.c. power ports, The test levels were applied on the EUT with a 2 Ω generator source impedance for power supply terminals and 12 Ω output impedance for interconnection lines. The tests were done at repetition rate one per minute.

Equipment Used: Refer to section 3 for details.

Test Result: See below table.

For AC mains power port			
Test Ports	Level	Result (Pursuant to EN 55035 Criterion B)	
Line to line	± 1.0 kV	<input checked="" type="checkbox"/> A	<input type="checkbox"/> B (see phenomena)
Lines to ground	± 2.0 kV	<input checked="" type="checkbox"/> A	<input type="checkbox"/> B (see phenomena)
<p>Remark: N/A: Not applicable</p> <p>Observation: <input checked="" type="checkbox"/> No observable change. <input type="checkbox"/> During the experiment, the following phenomena occurred:</p>			
<p>Conclusion: The EUT met the requirements of the standard.</p>			

6.5 IMMUNITY (ANALOGUE/DIGITAL DATA PORTS)

6.5.1 Continuous induced RF disturbances

Test Requirement: EN 55035:2017/A11:2020 Table Clause 2.1
Test Method: The test method shall be in accordance with IEC 61000-4-6
Criterion Required:

EN 55035	performance criteria A
----------	------------------------

Test Level:

EN 55035	0.15 MHz to 10 MHz: 3 V (r.m.s) 10 MHz to 30 MHz: 3 to 1 V (r.m.s) 30 MHz to 80 MHz: 1 V (r.m.s)
----------	--

Modulation: 80%, 1kHz Amplitude Modulation
Step Size: 1% increment
Dwell Time: 1s
Test Setup:

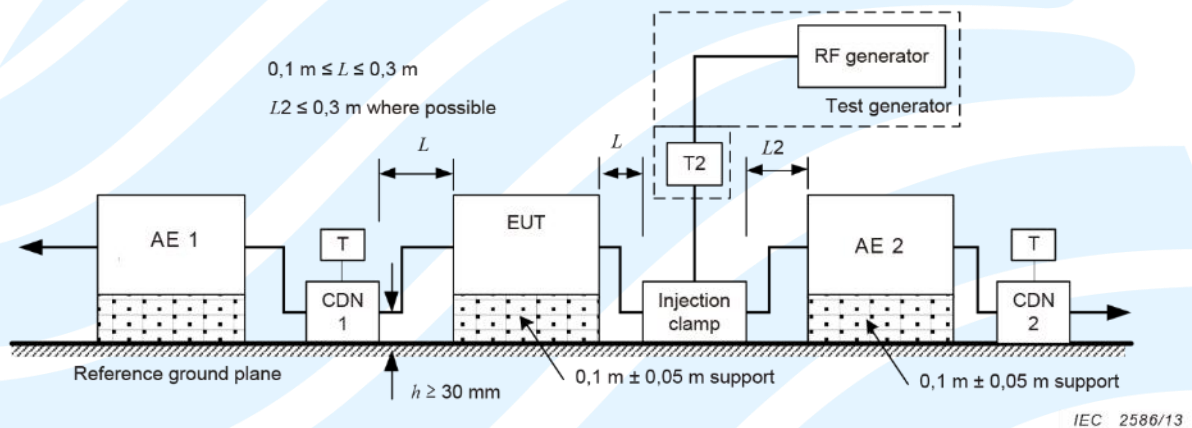

Schematic setup for immunity test used for injection clamp

- T Termination 50 Ω
- T2 Power attenuator (6 dB)
- CDN Coupling and decoupling network
- Injection clamp: Current clamp or EM clamp

b) Schematic setup for immunity test to RF conducted disturbances

Test setup for acoustic measurements

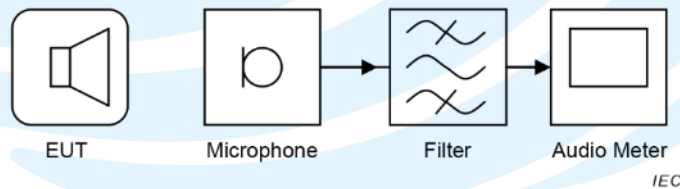

Test Procedures:

- 1) The Product and support units were located at a ground reference plane with the interposition of a 0.1 m thickness insulating support, and the telecommunication port under test was connected to support units through the current clamp.
- 2) The frequency range is swept from 150 kHz to 80MHz, with the signal 80% amplitude modulated with a 1 kHz sine wave. The rate of sweep did not exceed 1.5×10^{-3} decade/s. Where the frequency range is swept incrementally, the step size was 1% of fundamental.
- 3) The dwell time at each frequency shall be not less than the time necessary for the Product to be able to respond.

Equipment Used: Refer to section 3 for details.

Test Result: See below table.

Test Ports	Frequency	Level	Result (Pursuant to EN 55035 Criterion A)	
Antenna ports	0.15 MHz to 10 MHz 10 MHz to 30 MHz 30 MHz to 80 MHz	3 V 3 to 1 V 1 V	<input type="checkbox"/> A	<input checked="" type="checkbox"/> N/A
Wired network ports			<input checked="" type="checkbox"/> A	<input type="checkbox"/> N/A
Signal ports			<input type="checkbox"/> A	<input checked="" type="checkbox"/> N/A
Control ports			<input type="checkbox"/> A	<input checked="" type="checkbox"/> N/A
<p>Remark: N/A: Not applicable</p> <p>Observation: <input type="checkbox"/> No observable change. <input checked="" type="checkbox"/> The audio output signal level was monitored during test and was found to be at least 20dB less than the reference level recorded before the start of the test.</p> <p>Conclusion: The EUT met the requirements of the standard.</p>				

6.5.2 Surges

Test Requirement: EN 55035:2017/A11:2020 Table Clause 2.4
Test Method: The test method shall be in accordance with IEC 61000-4-5
Criterion Required:

EN 55035	performance criteria B
----------	------------------------

Wave Shape and Test level:

For EN 55035

	Port type: unshielded symmetrical Apply: lines to ground		Port type: coaxial or shielded Apply: shield to ground
	Apply where primary protection is intended	Apply where primary protection is not intended	
Open Circuit Voltage	10/700 μ s	10/700 μ s	1.2/50 μ s
Short Circuit Current	5/320 μ s	5/320 μ s	8/20 μ s
Test level	1 kV and 4 kV (Note 1, 2)	1 kV	0.5 kV (Note 3)

Note 1: Surges are applied with primary protection fitted. Where possible, use the actual primary protector intended to be used in the installation.

Note 2: Where the surge coupling network for the 10/700 (5/320) μ s waveform affects the functioning of high speed data ports, the test shall be carried out using a 1,2/50 (8/20) μ s waveform and appropriate coupling network.

Note 3: Surges are applicable to ports which satisfy all the following conditions:

- may connect directly to cables that leave the building structure,
- defined as an antenna port (3.1.3), a wired network port (3.1.34), or a broadcast receiver tuner port (3.1.8).

Typical ports covered include xDSL, PSTN, CATV, antenna and similar. Excluded ports are LAN and similar.

For ETSI EN 301 489-1

Test Level	<ul style="list-style-type: none"> - For outdoor cables(symmetrically): 1 kV (applied lines to ground) - For outdoor cables(non-symmetrically): 1 kV (applied line to ground, or shield to ground) and 0.5 kV (applied line to line) - For indoor cables: 0.5 kV (applied line to ground, or shield to ground) - In telecom centres 1 kV line to ground and 0.5 kV line to line shall be used.
Wave Shape	<ul style="list-style-type: none"> - For outdoor cables(symmetrically): 10/700 μs - For outdoor cables(non-symmetrically): 1.2/50μs - For indoor cables: 1.2/50μs

Polarity: Positive & Negative
Interval: 60s between each surge
No. of Surges:

EN 55035	5 positive at 90°, 5 negative at 270°
----------	---------------------------------------

Test Setup:

Test setup for surges applied to shielded lines

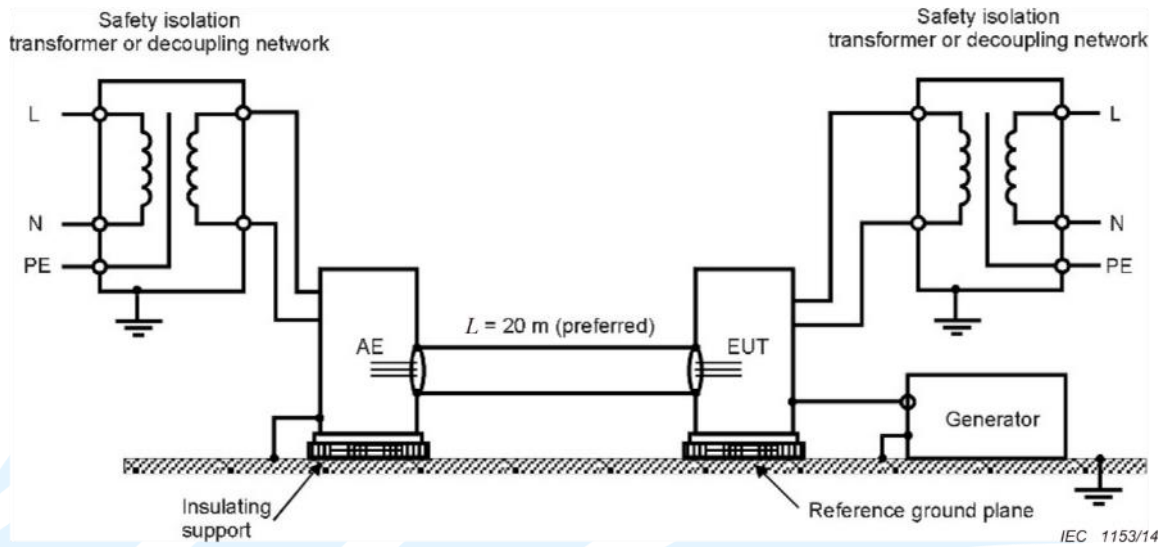

Test setup for unshielded symmetrical interconnection lines: lines-to-ground coupling via capacitors

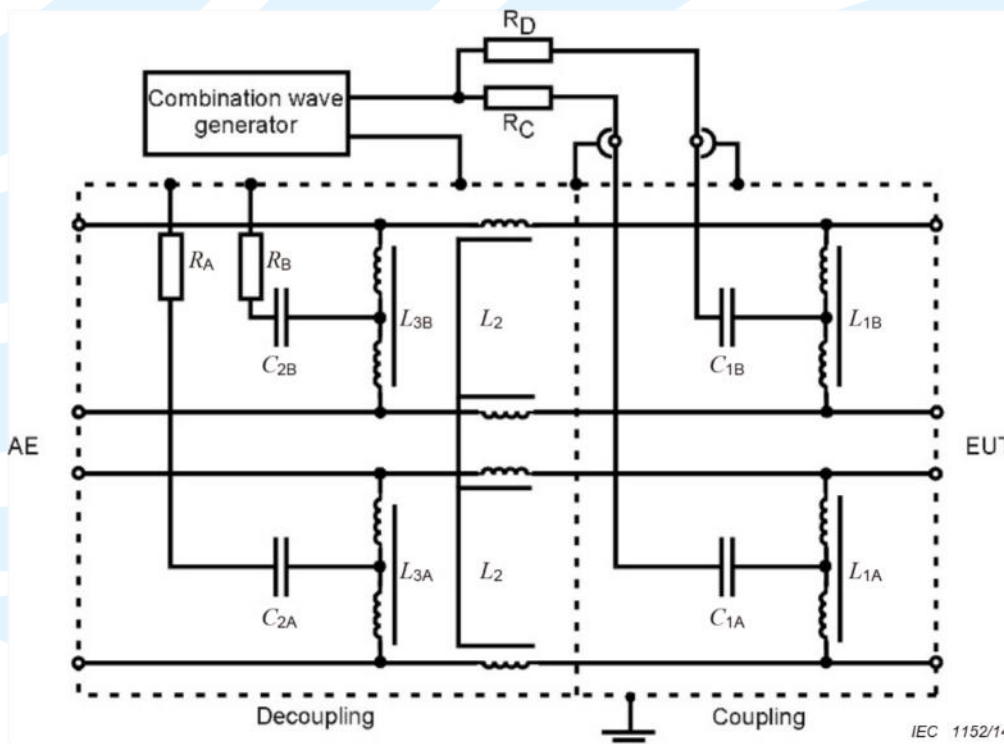

Equipment Used: Refer to section 3 for details.

Test Result: See below table.

Test Ports	Test Level	Result (Pursuant to EN 55035 Criterion B)		
		<input type="checkbox"/> A	<input type="checkbox"/> B (see phenomena)	<input checked="" type="checkbox"/> N/A
Antenna ports	± 0.5 kV	<input type="checkbox"/> A	<input type="checkbox"/> B (see phenomena)	<input checked="" type="checkbox"/> N/A
wired network ports unshielded symmetrical Apply where primary protection is intended	± 1 kV and ± 4 kV (lines to ground): 10/700 µs	<input type="checkbox"/> A	<input type="checkbox"/> B (see phenomena)	<input checked="" type="checkbox"/> N/A
wired network ports unshielded symmetrical Apply where primary protection is not intended	± 1 kV (lines to ground): 10/700 µs	<input checked="" type="checkbox"/> A	<input type="checkbox"/> B (see phenomena)	<input type="checkbox"/> N/A
wired network ports coaxial or shielded Apply	± 0.5 kV (shield to ground): 1.2/50 µs	<input type="checkbox"/> A	<input type="checkbox"/> B (see phenomena)	<input checked="" type="checkbox"/> N/A
Signal ports	± 0.5 kV	<input type="checkbox"/> A	<input type="checkbox"/> B (see phenomena)	<input checked="" type="checkbox"/> N/A
Control ports	± 0.5 kV	<input type="checkbox"/> A	<input type="checkbox"/> B (see phenomena)	<input checked="" type="checkbox"/> N/A
<p>Remark: N/A: Not applicable</p> <p>Observation: <input checked="" type="checkbox"/> No observable change. <input type="checkbox"/> During the experiment, the following phenomena occurred:</p>				
<p>Conclusion: The EUT met the requirements of the standard.</p>				

Remark: The testing of Surges (wired network ports) was performed in GRG Metrology & Test Group Co., Ltd.

6.5.3 Electrical fast transients/burst

Test Requirement: EN 55035:2017/A11:2020 Table Clause 2.5
Test Method: The test method shall be in accordance with IEC 61000-4-4
Criterion Required:

EN 55035	performance criteria B
----------	------------------------

Test Level and Repetition Frequency:

- The test level for signal ports, wired network ports (excluding xDSL), and control ports shall be 0,5 kV open circuit voltage at a repetition rate of 5 kHz as given in EN 61000-4-4;
- The test level for xDSL wired network ports shall be 0,5 kV open circuit voltage at a repetition rate of 100 kHz as given in EN 61000-4-4;

Impulse Wave shape: 5/50 ns
Burst Duration: 15ms
Burst Period: 300ms
Test Duration: 2 minute per level & polarity
Test Setup:

Test set-up for table-top equipment

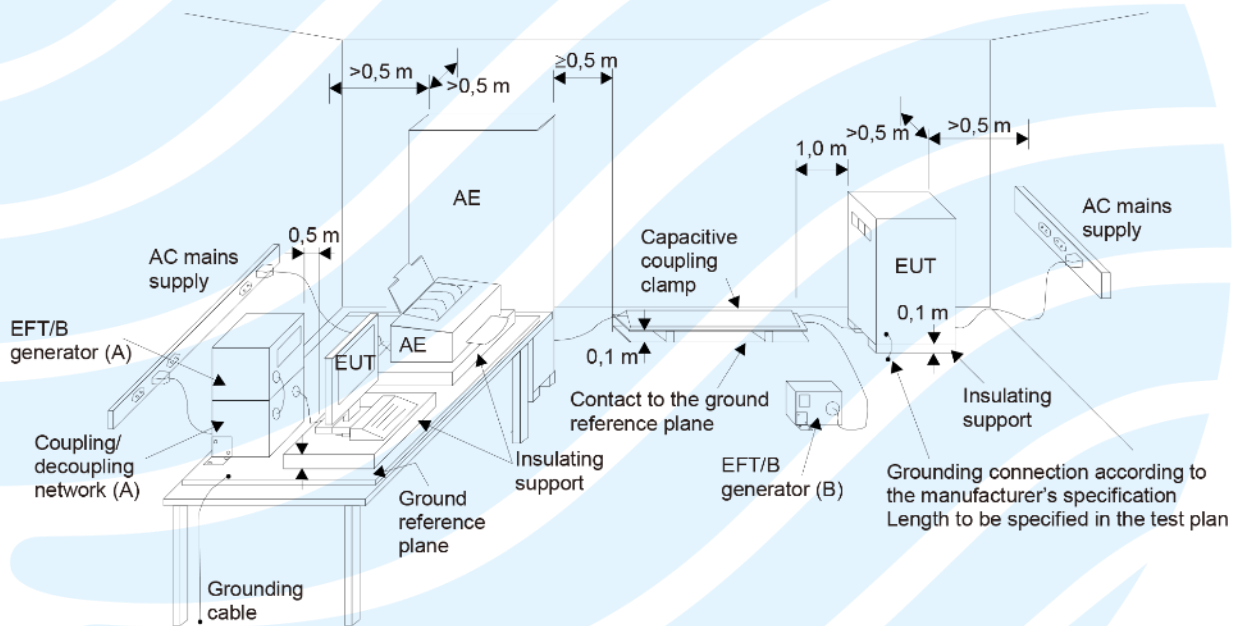

IEC 645/12

- (A) location for supply line coupling
- (B) location for signal lines coupling

Test setup for floor-standing equipment

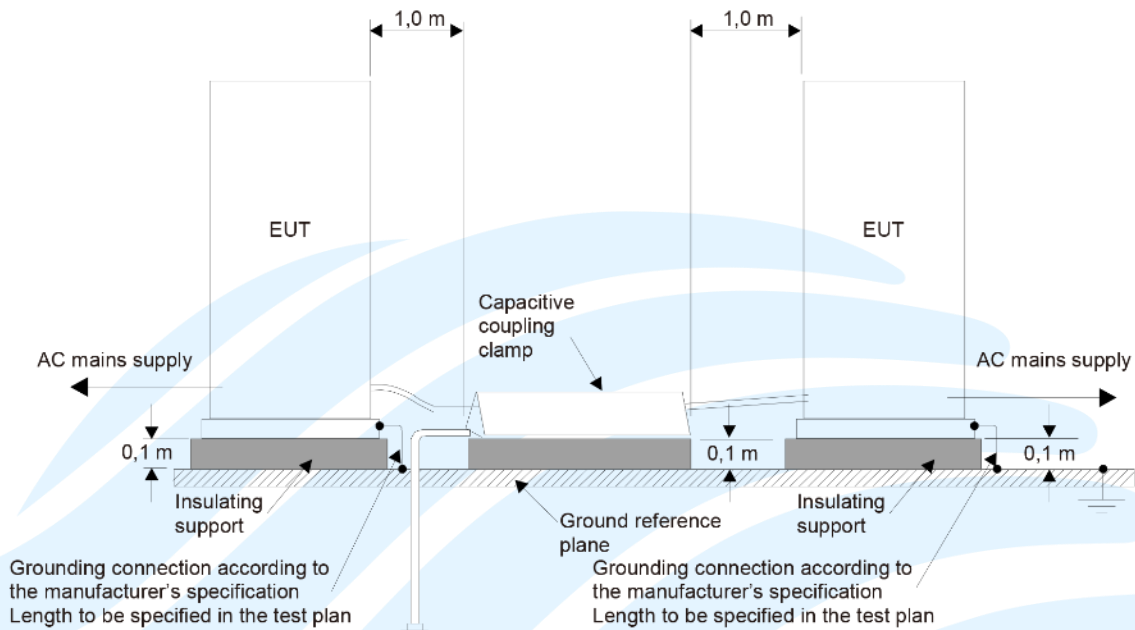

Equipment Used: Refer to section 3 for details.

Test Result: See below table.

Test Ports	Level (kV)	Result (Pursuant to EN 55035 Criterion B)		
		A	B (see phenomena)	N/A
Antenna ports	± 0.5	<input type="checkbox"/>	<input type="checkbox"/>	<input checked="" type="checkbox"/>
Wired network ports	± 0.5	<input checked="" type="checkbox"/>	<input type="checkbox"/>	<input type="checkbox"/>
Signal ports	± 0.5	<input type="checkbox"/>	<input type="checkbox"/>	<input checked="" type="checkbox"/>
Control ports	± 0.5	<input type="checkbox"/>	<input type="checkbox"/>	<input checked="" type="checkbox"/>

Remark:
N/A: Not applicable

Observation:
 No observable change.
 During the experiment, the following phenomena occurred:

Conclusion: The EUT met the requirements of the standard.

APPENDIX 1 PHOTOGRAPHS OF TEST SETUP

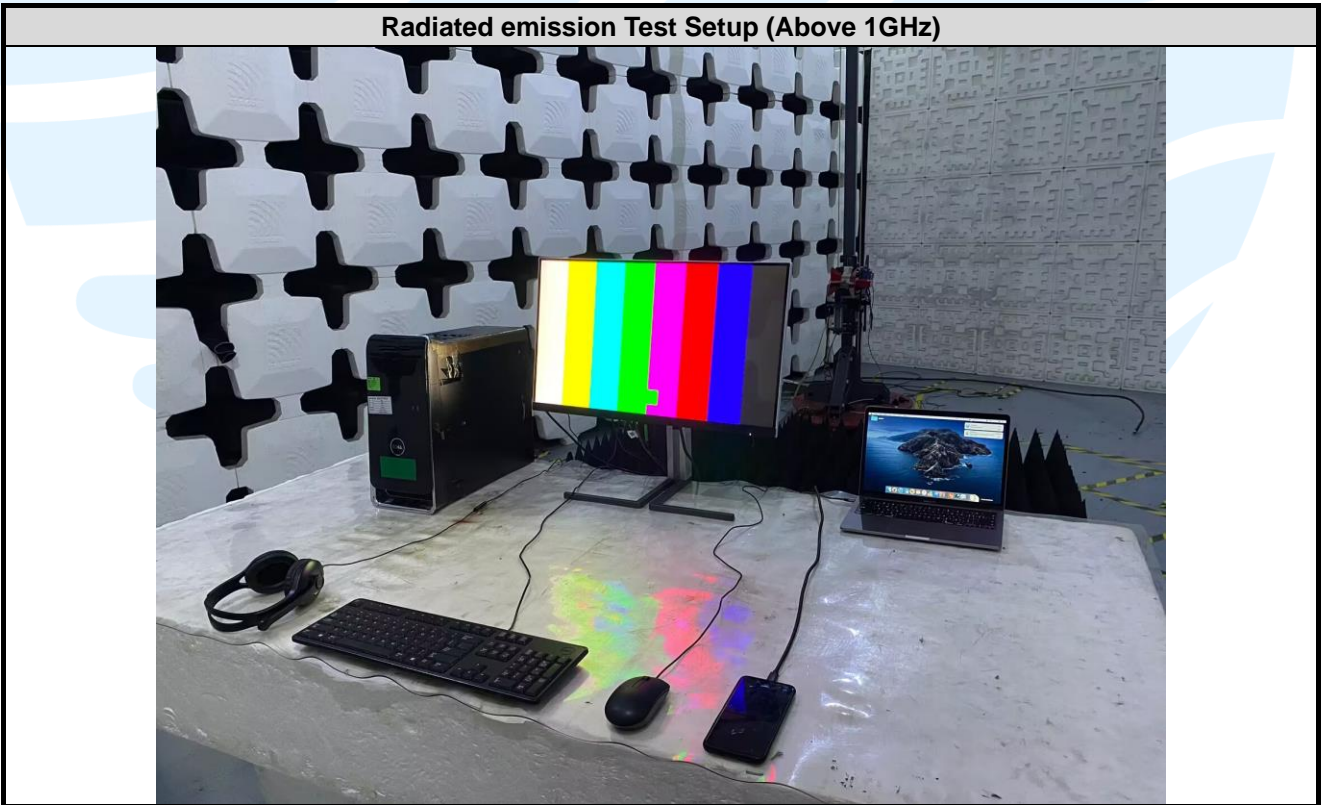
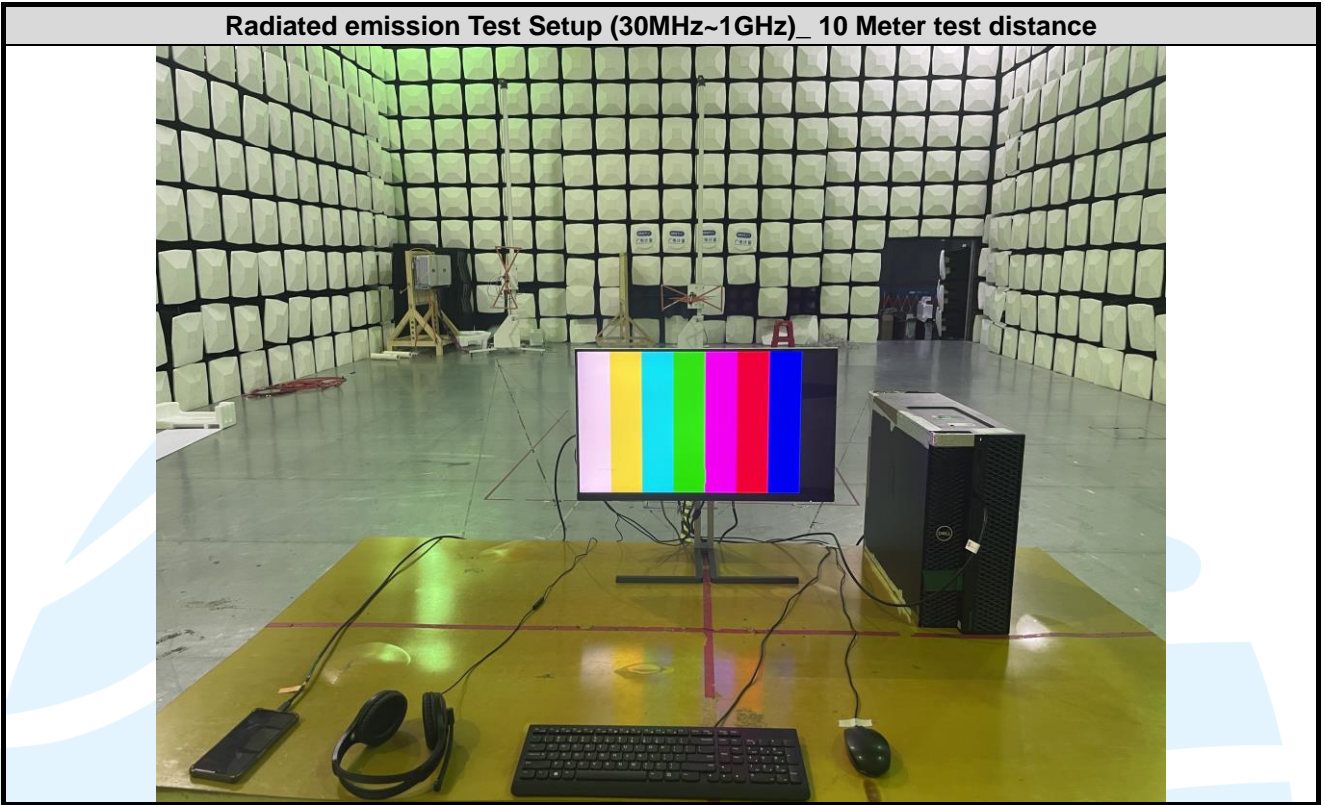

Conducted Emission (AC port) Test Setup

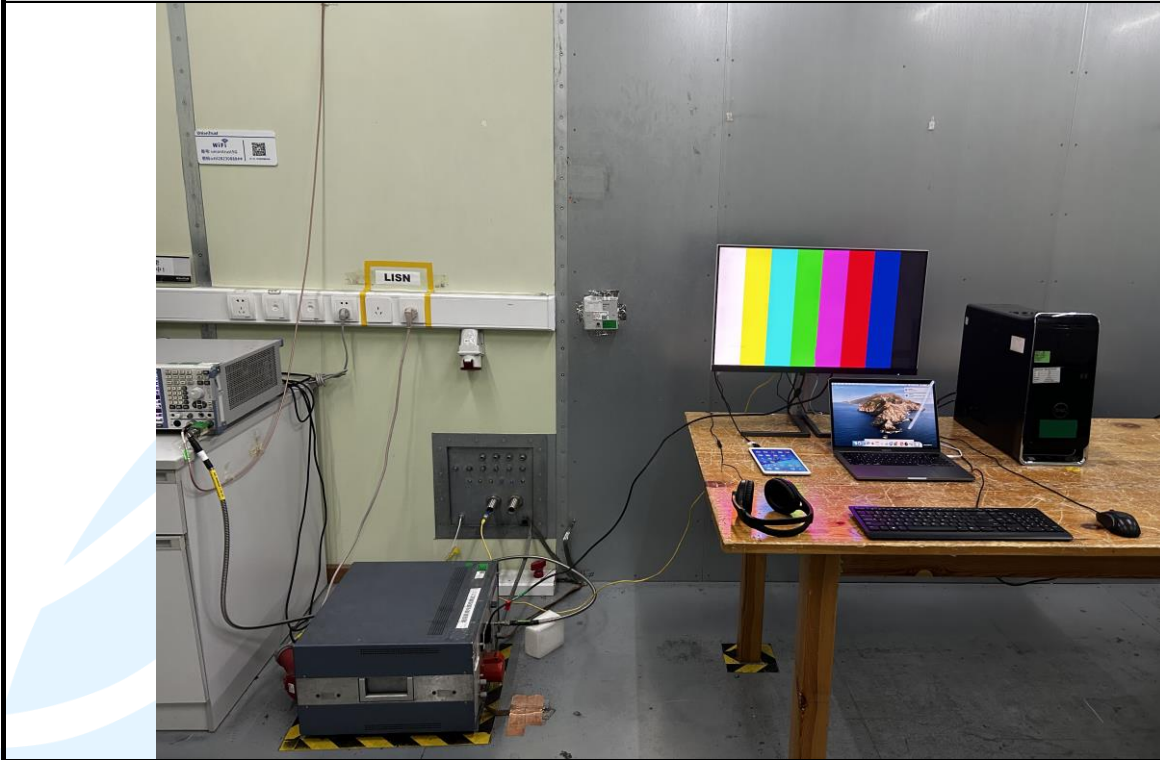

Conducted Emission (Wired network port) Test Setup

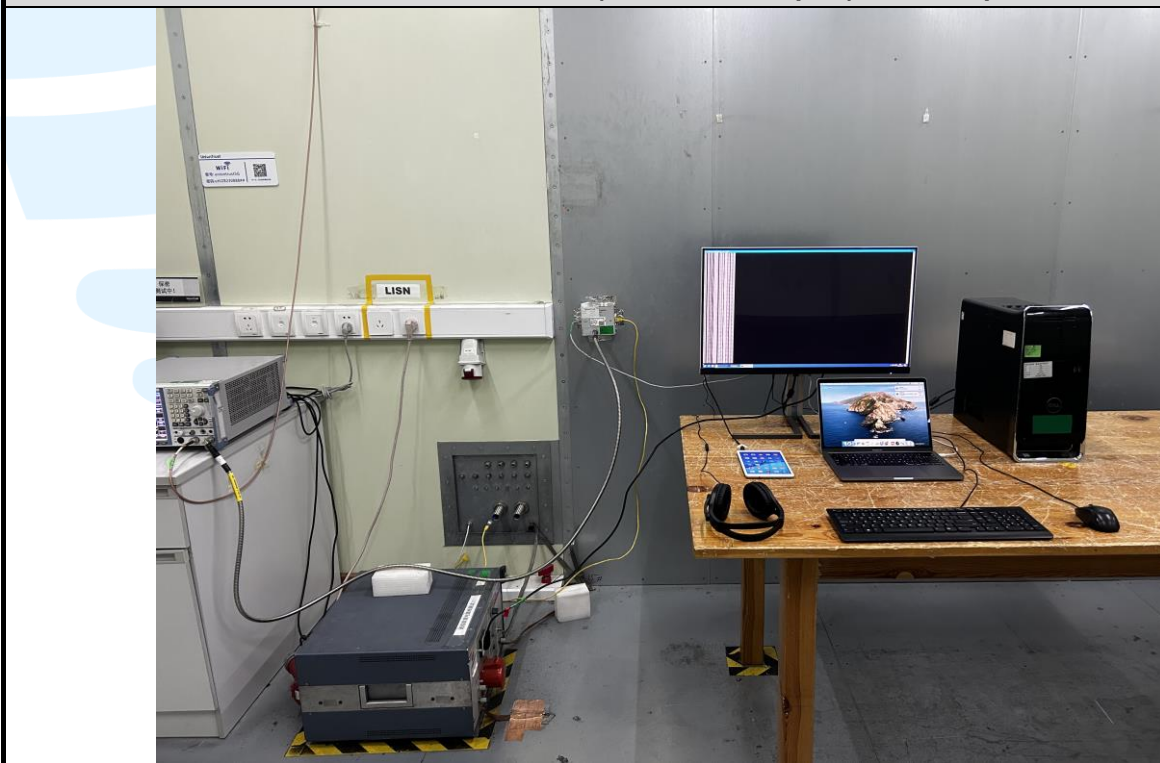

Harmonic & Flicker Test Setup



Electrostatic Discharge Test Setup



RF electromagnetic field Test Setup

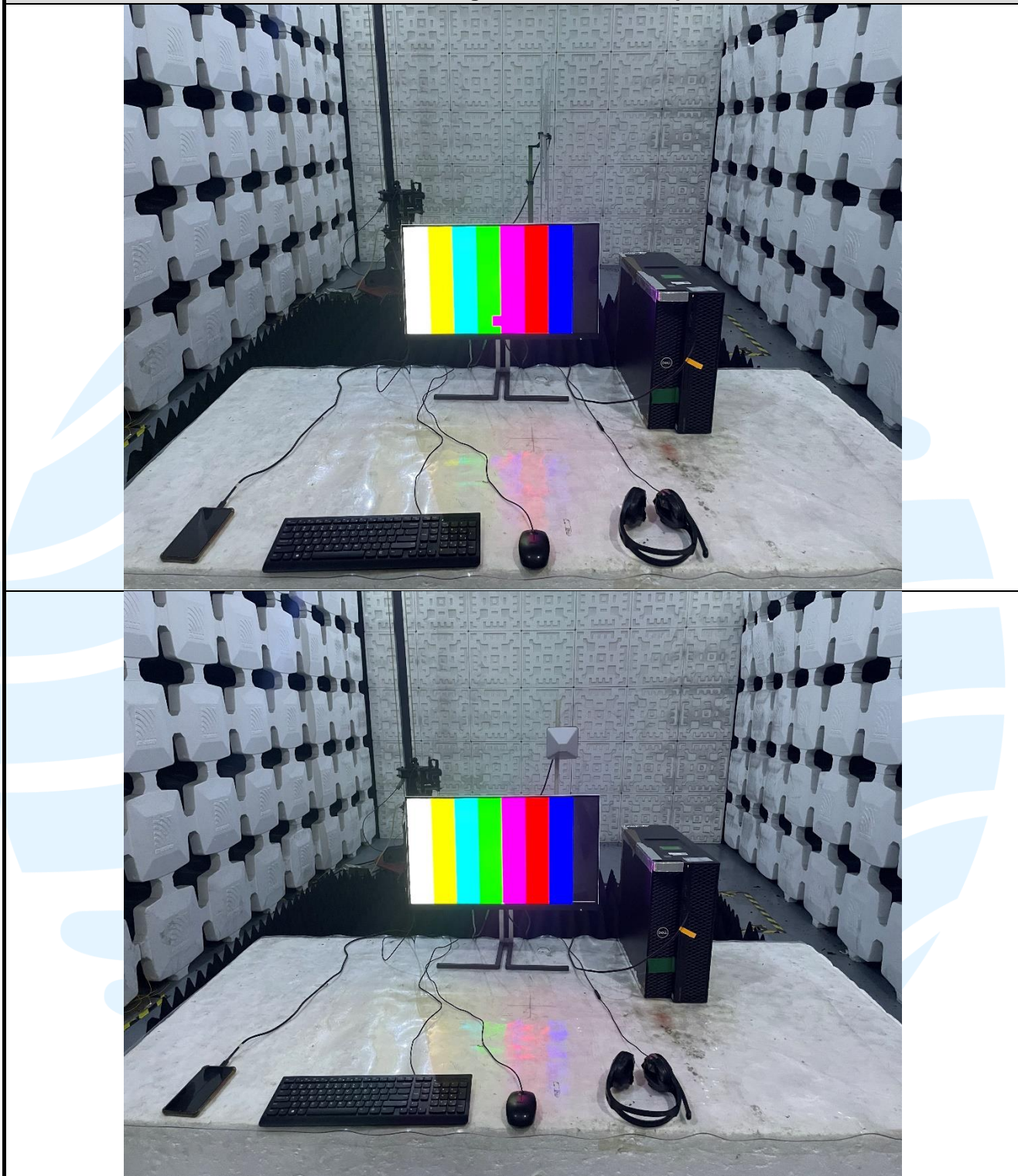

Fast Transients, Common mode / Surge Test Setup (AC Port) Test Setup



Fast Transients, Common mode (Wired network ports) Test Setup



Surge Test Setup (Wired network ports) Test Setup

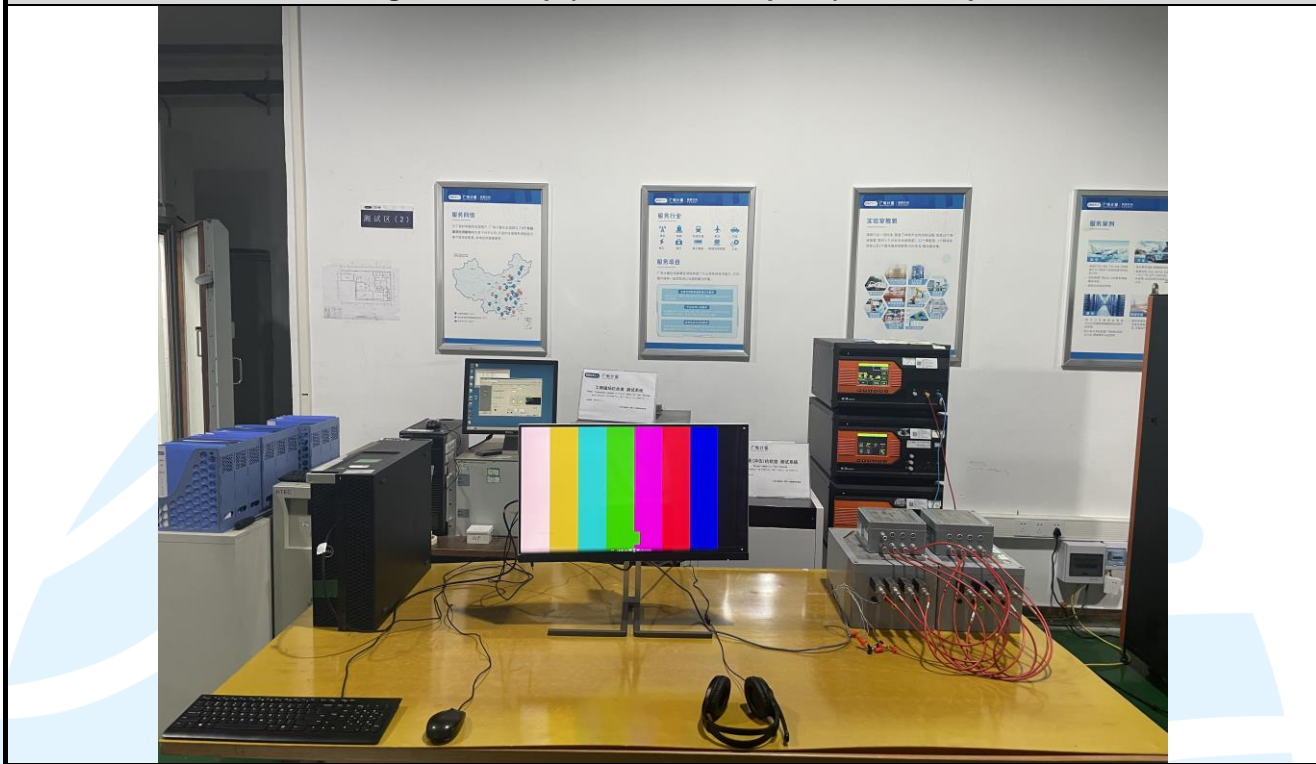

Radio frequency, common mode (AC Port) Test Setup



Radio frequency, common mode (Wired network ports) Test Setup



Power frequency magnetic field Test Setup



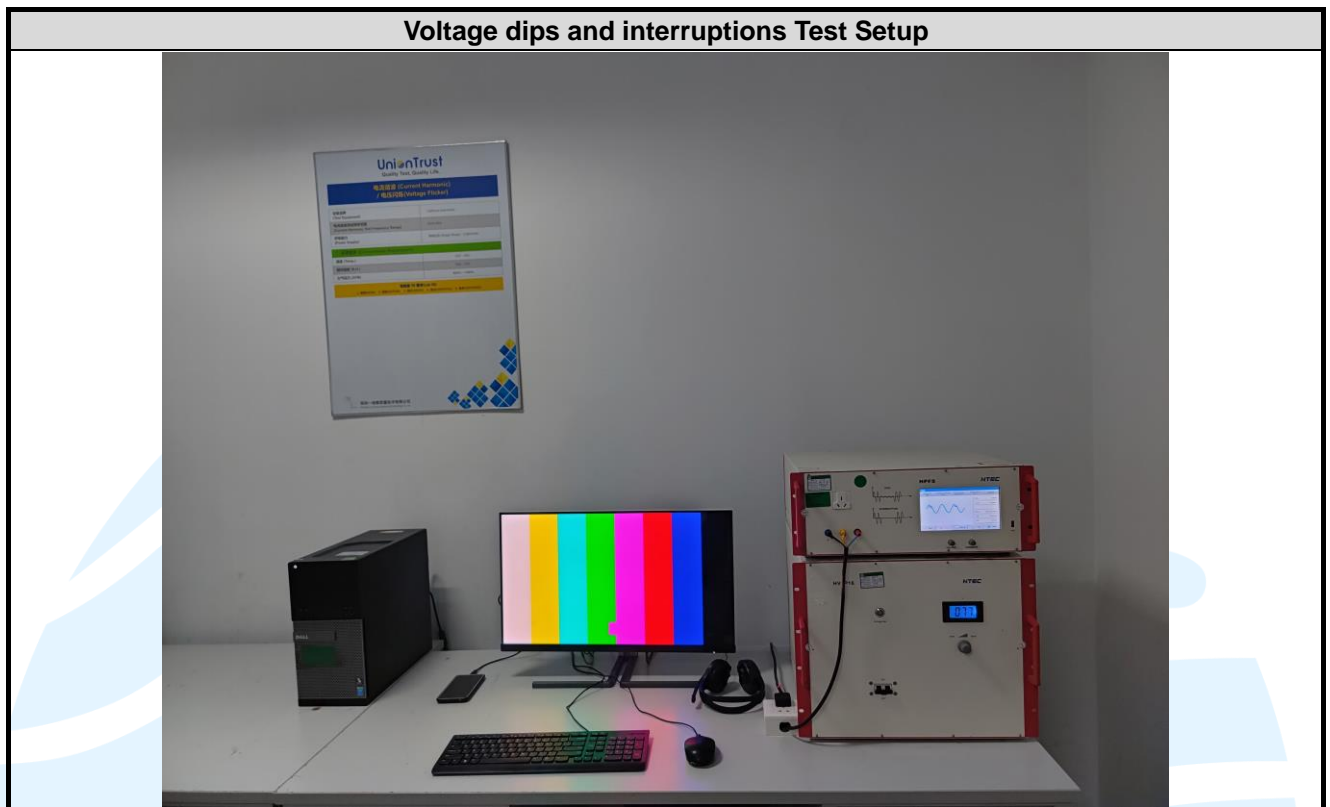

Shenzhen UnionTrust Quality and Technology Co., Ltd.

Address: Unit D/E of 9/F and 16/F, Block A, Building 6, Baoneng science and technology park, Longhua district, Shenzhen, China

Tel: +86-755-28230888

Fax: +86-755-28230886

E-mail: info@uttlab.com

<http://www.uttlab.com>

UTTR-EMC-EN55032-V1.2

APPENDIX 2 PHOTOGRAPHS OF EUT CONSTRUCTIONAL DETAILS

Refer to Appendix 2 for EUT external and internal photos.

*** End of Report ***

The test report is effective only with both signature and specialized stamp. The result(s) shown in this report refer only to the sample(s) tested. Without written approval of UnionTrust, this report can't be reproduced except in full.
