

FCC& ISED EMC Test Report

Project No. : 2002C094
Equipment : LCD Monitor
Brand Name : N/A
Test Model : **27P2*****(*=0-9,A-Z,a-z,+,-,/, \ or blank)
Series Model : N/A
Applicant : TPV Electronics (Fujian) Co., Ltd.
Address : Rongqiao Economic and Technological Development Zone, Fuqing City,
Fujian Province, P.R. China
Date of Receipt : Feb. 28, 2020
Date of Test : Mar. 06, 2020 ~ Apr. 01, 2020
Issued Date : Apr. 15, 2020
Report Version : R00
Test Sample : Engineering Sample No.: DG2020030649, DG2020030648
Standard(s) : FCC Part 15, Subpart B
ICES-003 Issue 6:2016
ICES-003 Issue 6:2016 (updated April 2019)

The above equipment has been tested and found compliance with the requirement of the relative standards by BTL Inc.

Derek Tong

Prepared by : Derek Tong

Kevin Li

Approved by : Kevin Li



Certificate #5123.02

Add: No.3, Jinshagang 1st Road, Shixia, Dalang Town, Dongguan, Guangdong, China.

Tel: +86-769-8318-3000

Web: www.newbtl.com

Declaration

BTL represents to the client that testing is done in accordance with standard procedures as applicable and that test instruments used has been calibrated with standards traceable to international standard(s) and/or national standard(s).

BTL's reports apply only to the specific samples tested under conditions. It is manufacture's responsibility to ensure that additional production units of this model are manufactured with the identical electrical and mechanical components. **BTL** shall have no liability for any declarations, inferences or generalizations drawn by the client or others from **BTL** issued reports.

The report must not be used by the client to claim product certification, approval, or endorsement by NIST, A2LA, or any agency of the U.S. Government.

This report is the confidential property of the client. As a mutual protection to the clients, the public and ourselves, the test report shall not be reproduced, except in full, without our written approval.

BTL's laboratory quality assurance procedures are in compliance with the **ISO/IEC 17025** requirements, and accredited by the conformity assessment authorities listed in this test report.

BTL is not responsible for the sampling stage, so the results only apply to the sample as received.

The information, data and test plan are provided by manufacturer which may affect the validity of results, so it is manufacturer's responsibility to ensure that the apparatus meets the essential requirements of applied standards and in all the possible configurations as representative of its intended use.

Limitation

For the use of the authority's logo is limited unless the Test Standard(s)/Scope(s)/Item(s) mentioned in this test report is (are) included in the conformity assessment authorities acceptance respective.

Please note that the measurement uncertainty is provided for informational purpose only and are not use in determining the Pass/Fail results.

Table of Contents	Page
REPORT ISSUED HISTORY	4
1 . SUMMARY OF TEST RESULTS	5
1.1 TEST FACILITY	6
1.2 MEASUREMENT UNCERTAINTY	6
1.3 TEST ENVIRONMENT CONDITIONS	6
2 . GENERAL INFORMATION	7
2.1 GENERAL DESCRIPTION OF EUT	7
2.2 DESCRIPTION OF TEST MODES	8
2.3 EUT OPERATING CONDITIONS	10
2.4 BLOCK DIAGRAM SHOWING THE CONFIGURATION OF SYSTEM TESTED	10
2.5 DESCRIPTION OF SUPPORT UNITS	12
3 . EMC EMISSION TEST	14
3.1 AC POWER LINE CONDUCTED EMISSIONS TEST	14
3.1.1 LIMIT	14
3.1.2 MEASUREMENT INSTRUMENTS LIST	14
3.1.3 TEST PROCEDURE	15
3.1.4 DEVIATION FROM TEST STANDARD	15
3.1.5 TEST SETUP	15
3.1.6 TEST RESULTS	15
3.2 RADIATED EMISSIONS 30 MHZ TO 1 GHZ	28
3.2.1 LIMIT	28
3.2.2 MEASUREMENT INSTRUMENTS LIST	28
3.2.3 TEST PROCEDURE	29
3.2.4 DEVIATION FROM TEST STANDARD	29
3.2.5 TEST SETUP	29
3.2.6 TEST RESULTS	29
3.3 RADIATED EMISSIONS ABOVE 1 GHZ	42
3.3.1 LIMIT	42
3.3.2 MEASUREMENT INSTRUMENTS LIST	42
3.3.3 TEST PROCEDURE	43
3.3.4 DEVIATION FROM TEST STANDARD	43
3.3.5 TEST SETUP	43
3.3.6 TEST RESULTS-ABOVE 1 GHZ	44
4 . EUT TEST PHOTO	57

REPORT ISSUED HISTORY

Report Version	Description	Issued Date
R00	Original Issue.	Apr. 15, 2020

1. SUMMARY OF TEST RESULTS

Emission		
Ref Standard(s)	Test Item	Result
ANSI C63.4-2014	AC Power Line Conducted Emissions	PASS
	Radiated Emissions 30 MHz to 1 GHz	PASS
	Radiated Emissions Above 1 GHz	PASS

1.1 TEST FACILITY

The test facilities used to collect the test data in this report at the location of No.3, Jinshagang 1st Road, Shixia, Dalang Town, Dongguan, Guangdong, China.

BTL's Test Firm Registration Number for FCC: 357015

BTL's Designation Number for FCC: CN1240

BTL's Test Firm Registration Number for ISCED: 4428B

1.2 MEASUREMENT UNCERTAINTY

ISO/IEC 17025 requires that an estimate of the measurement uncertainties associated with the emissions test results be included in the report. The measurement uncertainties given below are based on a 95% confidence level (based on a coverage factor (k=2))

The BTL measurement uncertainty as below table:

A. AC power line conducted emissions test:

Test Site	Method	Measurement Frequency Range	U,(dB)
DG-C02	CISPR	150 kHz ~ 30MHz	2.60

B. Radiated emissions test:

Test Site	Method	Measurement Frequency Range	Ant. H / V	U,(dB)
DG-CB08 (3m)	CISPR	30MHz ~ 200MHz	V	3.76
		30MHz ~ 200MHz	H	3.56
		200MHz ~ 1,000MHz	V	4.00
		200MHz ~ 1,000MHz	H	3.90

Test Site	Method	Measurement Frequency Range	U,(dB)
DG-CB08 (3m)	CISPR	1GHz ~ 6GHz	4.36

Note: Unless specifically mentioned, the uncertainty of measurement has not been taken into account to declare the compliance or non-compliance to the specification.

1.3 TEST ENVIRONMENT CONDITIONS

Test Item	Temperature	Humidity	Tested By
AC Power Line Conducted Emissions	25°C	53%	Gatsby Wang
Radiated emissions 30 MHz to 1 GHz	25°C	60%	Promise Yin
Radiated emissions above 1 GHz	25°C	60%	Promise Yin

2. GENERAL INFORMATION

2.1 GENERAL DESCRIPTION OF EUT

Equipment	LCD Monitor
Brand Name	N/A
Test Model	**27P2*****(*=0-9,A-Z,a-z,+,-,/,\ or blank)
Series Model	N/A
Model Difference(s)	N/A
Power Source	AC Mains.
Power Rating	100-240V~ 50-60Hz
Connecting I/O Port(s)	Please refer to Note 3
Classification Of EUT□	Clas B
Highest Internal Frequency(Fx)	600 MHz

Cable Type	Shielded Type	Ferrite Core	Length(m)	Note
AC Power Cord	Non-shielded	NO	1.8/1.5	1.8m is worst case Detachable
HDMI	Shielded	NO	1.8/1.5	/
DP	Shielded	NO	1.8/1.5	/
DVI	Shielded	YES	1.8/1.5	Bonded two Ferrite Cores
USB	Shielded	NO	1.8/1.5	/
AUDIO	Non-shielded	NO	1.8/1.5	/
D-SUB	Shielded	YES	1.8/1.5	Bonded two Ferrite Cores

Note:

- For a more detailed features description, please refer to the manufacturer's specifications or the user's manual.
- 27P2Q: Power cable 1.8m, 1.5m length, worst case is Power cable 1.8m with DPI + DVI++HDMI+ D-USB+ AUDIO+ SUB length testing and recording in test report.
27P2U: Power cable 1.8m,1.5m length, worst case is Power cable 1.8m with DP + HDMI+ D-SUB+USB length testing and recording in test report.
-

Model	I/O Port(s)
27P2Q	1* DP port 1* DVI port 1* HDMI port 1* D-SUB port 1* AUDIO port 1* Earphone port 5* USB port 1* AC port
27P2U	1* DP port 1* HDMI port 1* D-SUB port 1* Earphone port 5* USB port 1* AC port

2.2 DESCRIPTION OF TEST MODES

To investigate the maximum EMI emission characteristics generated from EUT, the test system was pre-scanning tested based on the consideration of following EUT operation mode or test configuration mode which possibly have effect on EMI emission level. Each of these EUT operation mode(s) or test configuration mode(s) mentioned above was evaluated respectively.

27P2Q:

Pretest Mode	Description
Mode 1	HDMI 1920*1080/75Hz 1.8m H
Mode 2	D-SUB 1920*1080/60Hz 1.8m H
Mode 3	DP 1920*1080/175Hz 1.8m H
Mode 4	DVI 1920*1080/60Hz 1.8m H
Mode 5	HDMI 1080P 1.8m H
Mode 6	HDMI 1280*720/60Hz 1.8m H
Mode 7	HDMI 640*480/60Hz 1.8m H
Mode 8	HDMI 1920*1080/60Hz 1.5m H
Mode 9	HDMI 1920*1080/75Hz 1.8m V

AC Power Line Conducted Emissions test	
Final Test Mode	Description
Mode 1	HDMI 1920*1080/75Hz 1.8m H
Mode 2	D-SUB 1920*1080/60Hz 1.8m H
Mode 5	HDMI 1080P 1.8m H

Radiated emissions 30 MHz to 1 GHz test	
Final Test Mode	Description
Mode 1	HDMI 1920*1080/75Hz 1.8m H
Mode 2	D-SUB 1920*1080/60Hz 1.8m H
Mode 5	HDMI 1080P 1.8m H

Radiated emissions Above 1 GHz test	
Final Test Mode	Description
Mode 1	HDMI 1920*1080/75Hz 1.8m V
Mode 2	D-SUB 1920*1080/60Hz 1.8m V
Mode 5	HDMI 1080P 1.8m V

Evaluation description:

1. The maximum resolution is evaluated Mode 1-5. The worst case is Mode 1 and evaluated the middle and low resolution Mode 6 and Mode 7.
2. According to the client's requirement, choose Mode 1, Mode 2, Mode 5 and recorded in test report.

27P2U:

Pretest Mode	Description
Mode 1	HDMI 1920*1080/75Hz 1.8m V
Mode 2	D-SUB 1920*1080/60Hz 1.8m V
Mode 3	DP 1920*1080/175Hz 1.8m V
Mode 4	HDMI 1080P 1.8m V
Mode 5	HDMI 1280*720/60Hz 1.8m V
Mode 6	HDMI 640*480/60Hz 1.8m V
Mode 7	HDMI 1920*1080/60Hz 1.5m V
Mode 8	HDMI 1920*1080/75Hz 1.8m H

AC Power Line Conducted Emissions test	
Final Test Mode	Description
Mode 1	HDMI 1920*1080/75Hz 1.8m V
Mode 2	D-SUB 1920*1080/60Hz 1.8m V
Mode 4	HDMI 1080P 1.8m V

Radiated emissions 30 MHz to 1 GHz test	
Final Test Mode	Description
Mode 1	HDMI 1920*1080/75Hz 1.8m V
Mode 2	D-SUB 1920*1080/60Hz 1.8m V
Mode 4	HDMI 1080P 1.8m V

Radiated emissions Above 1 GHz test	
Final Test Mode	Description
Mode 1	HDMI 1920*1080/75Hz 1.8m V
Mode 2	D-SUB 1920*1080/60Hz 1.8m V
Mode 4	HDMI 1080P 1.8m V

Evaluation description:

1. The maximum resolution is evaluated Mode 1-4. The worst case is Mode 1 and evaluated the middle and low resolution Mode 5 and Mode 6.
2. According to the client's requirement, choose Mode 1, Mode 2, Mode 4 and recorded in test report.

2.3 EUT OPERATING CONDITIONS

The EUT exercise program used during radiated and/or conducted emission measurement was designed to exercise the various system components in a manner similar to a typical use. The standard test signals and output signal as following:

27P2Q:

1. EUT connected to PC via HDMI&DP&D-USB&AUDIO&DVI &USB cable.
2. Mouse and Keyboard connected to PC via USB cable.
3. EUT connected to Earphone via Earphone cable.
4. EUT connected to USB3.0 Hard Disk via USB cable.
5. Modem connected to PC via RS232 Cable.
6. Printer connected to PC via Parallel Cable.

27P2U:

1. EUT connected to PC via HDMI&DP&D-USB&USB cable.
2. Mouse and Keyboard connected to PC via USB cable.
3. EUT connected to Earphone via Earphone cable.
4. EUT connected to USB3.0 Hard Disk via USB cable.
5. Modem connected to PC via RS232 Cable.
6. Printer connected to PC via Parallel Cable.

2.4 BLOCK DIAGRAM SHOWING THE CONFIGURATION OF SYSTEM TESTED

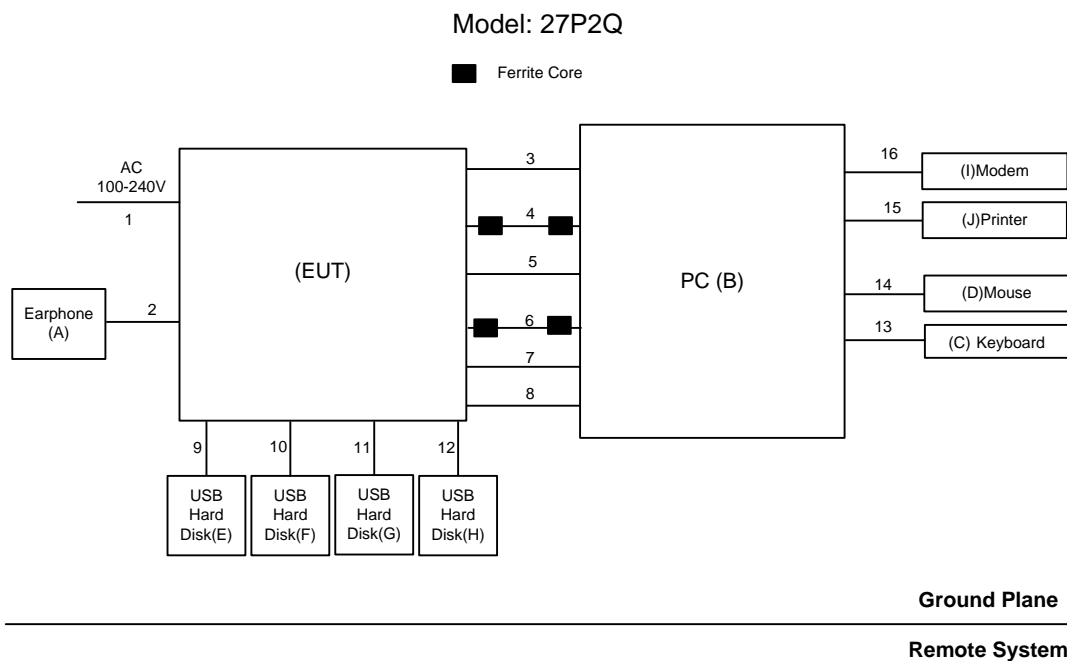

Model: 27P2U

■ Ferrite Core

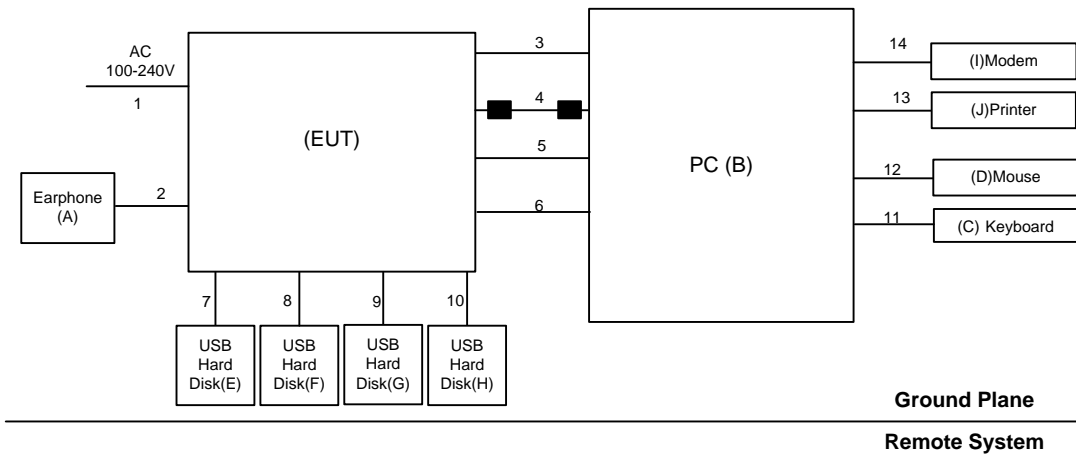

2.5 DESCRIPTION OF SUPPORT UNITS

The EUT has been tested as an independent unit together with other necessary accessories or support units. The following support units or accessories were used to form a representative test configuration during the tests.

27P2Q:

Item	Equipment	Mfr/Brand	Model/Type No.	Series No.
A	Earphone	APPLE	N/A	N/A
B	PC	DELL	Vostro 470	24454162837
C	Keyboard	DELL	KB212-B	CN0HTXH97158125004DXA01
D	Mouse	DELL	MS111-P	CN011D3V71581279OLOT
E	USB Hard Disk	WD	WDBBLW5000AAL	WX31AA323251
F	USB Hard Disk	WD	WDBBLW5000AAL	WX81A64A5EJ5
G	USB Hard Disk	WD	WDBBLW5000AAL	WX31A93J5223
H	USB Hard Disk	WD	WDBBLW5000AAL	WX31AA323251
I	Modem	ACEEX	DM-1414V	603002131
J	Printer	SII	DPU-414	3018507 B

Item	Cable Type	Shielded Type	Ferrite Core	Length
1	AC Cable	NO	NO	1.8/1.5m
2	Earphone Cable	NO	NO	1.2m
3	HDMI Cable	YES	NO	1.8/1.5m
4	D-SUB Cable	YES	YES	1.8/1.5m
5	DP Cable	YES	NO	1.8/1.5m
6	DVI Cable	YES	YES	1.8/1.5m
7	Audio Cable	NO	NO	1.8/1.5m
8	USB Cable	YES	NO	1.8/1.5m
9	USB Cable	YES	NO	1.0m
10	USB Cable	YES	NO	1.0m
11	USB Cable	YES	NO	1.0m
12	USB Cable	YES	NO	1.0m
13	USB Cable	YES	NO	1.8m
14	USB Cable	YES	NO	1.8m
15	Parallel Cable	YES	NO	1.8m
16	RS232 Cable	YES	NO	1.8m

27P2U:

Item	Equipment	Mfr/Brand	Model/Type No.	Series No.
A	Earphone	APPLE	N/A	N/A
B	PC	DELL	Vostro 470	24454162837
C	Keyboard	DELL	KB212-B	CN0HTXH97158125004DXA01
D	Mouse	DELL	MS111-P	CN011D3V71581279OLOT
E	USB Hard Disk	WD	WDBBLW5000AAL	WX31AA323251
F	USB Hard Disk	WD	WDBBLW5000AAL	WX81A64A5EJ5
G	USB Hard Disk	WD	WDBBLW5000AAL	WX31A93J5223
H	USB Hard Disk	WD	WDBBLW5000AAL	WX31AA323251
I	Modem	ACEEX	DM-1414V	603002131
J	Printer	SII	DPU-414	3018507 B

Item	Cable Type	Shielded Type	Ferrite Core	Length
1	AC Cable	NO	NO	1.8/1.5m
2	Earphone Cable	NO	NO	1.2m
3	HDMI Cable	YES	NO	1.8/1.5m
4	D-SUB Cable	YES	YES	1.8/1.5m
5	DP Cable	YES	NO	1.8/1.5m
6	USB Cable	YES	NO	1.8/1.5m
7	USB Cable	YES	NO	1.0m
8	USB Cable	YES	NO	1.0m
9	USB Cable	YES	NO	1.0m
10	USB Cable	YES	NO	1.0m
11	USB Cable	YES	NO	1.8m
12	USB Cable	YES	NO	1.8m
13	Parallel Cable	YES	NO	1.8m
14	RS232 Cable	YES	NO	1.8m

3. EMC EMISSION TEST

3.1 AC POWER LINE CONDUCTED EMISSIONS TEST

3.1.1 LIMIT

Frequency of Emission (MHz)	Class B (dBuV)	
	Quasi-peak	Average
0.15 - 0.5	66 - 56 *	56 - 46 *
0.5 - 5.0	56.00	46.00
5.0 - 30.0	60.00	50.00

Note:

- (1) The tighter limit applies at the band edges.
- (2) The limit of " * " marked band means the limitation decreases linearly with the logarithm of the frequency in the range.
- (3) The test result calculated as following:
 Measurement Value = Reading Level + Correct Factor
 Correct Factor = Insertion Loss + Cable Loss + Attenuator Factor(if use)
 Margin Level = Measurement Value - Limit Value

3.1.2 MEASUREMENT INSTRUMENTS LIST

Item	Kind of Equipment	Manufacturer	Type No.	Serial No.	Calibrated until
1	EMI Test Receiver	R&S	ESCI	100382	Feb. 28, 2021
2	LISN	EMCO	3816/2	52765	Mar. 01, 2021
3	TWO-LINE V-NETWORK	R&S	ENV216	101447	May. 19, 2020
4	50Ω Terminator	SHX	TF5-3	15041305	Mar. 01, 2021
5	Measurement Software	Farad	EZ-EMC Ver.NB-03A1-01	N/A	N/A
6	Cable	N/A	RG223	12m	Mar. 10, 2021

Remark: "N/A" denotes no model name, serial no. or calibration specified.

All calibration period of equipment list is one year.

3.1.3 TEST PROCEDURE

- a. The EUT was placed 0.8 meters from the horizontal ground plane with EUT being connected to the power mains through a line impedance stabilization network (LISN). All other support equipment powered from additional LISN(s). The LISN provide 50 Ohm/ 50uH of coupling impedance for the measuring instrument.
- b. Interconnecting cables that hang closer than 40 cm to the ground plane shall be folded back and forth in the center forming a bundle 30 to 40 cm long.
- c. I/O cables that are not connected to a peripheral shall be bundled in the center. The end of the cable may be terminated, if required, using the correct terminating impedance. The overall length shall not exceed 1 m.
- d. LISN at least 80 cm from nearest part of EUT chassis.
- e. For the actual test configuration, please refer to the related Item –EUT Test Photos.
- f. Measuring frequency range from 150KHz to 30MHz.

3.1.4 DEVIATION FROM TEST STANDARD

No deviation

3.1.5 TEST SETUP

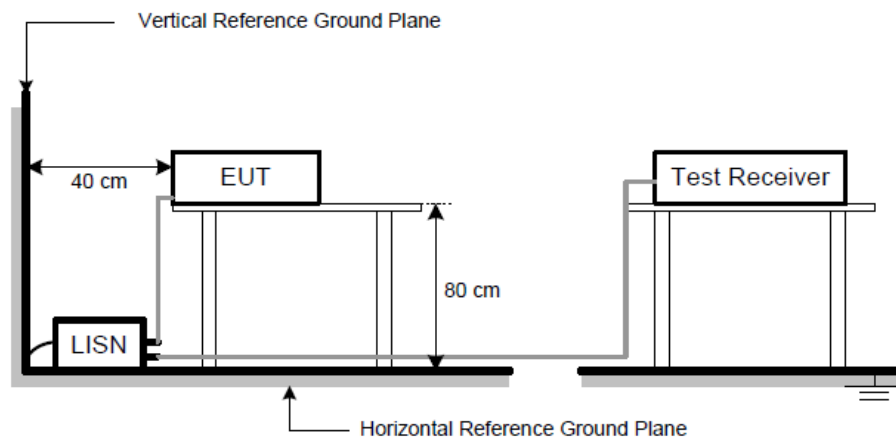

3.1.6 TEST RESULTS

Remark

- (1) Reading in which marked as QP means measurements by using are Quasi-Peak Mode with Detector BW=9 kHz; SPA setting in RBW=10 kHz, VBW =10 kHz, Swp. Time = 0.3 sec./MHz. Reading in which marked as AV means measurements by using are Average Mode with instrument setting in RBW=10 kHz, VBW=10 kHz, Swp. Time =0.3 sec./MHz.
- (2) All readings are QP Mode value unless otherwise stated AVG in column of 『Note』 . If the QP Mode Measured value compliance with the QP Limits and lower than AVG Limits, the EUT shall be deemed to meet both QP & AVG Limits and then only QP Mode was measured, but AVG Mode didn't perform. In this case, a “ * ” marked in AVG Mode column of Interference Voltage Measured.

Test Voltage	AC 120V/60Hz	Phase	Line
Test Mode	HDMI 1920*1080/75Hz 1.8m H		
Model	27P2Q		

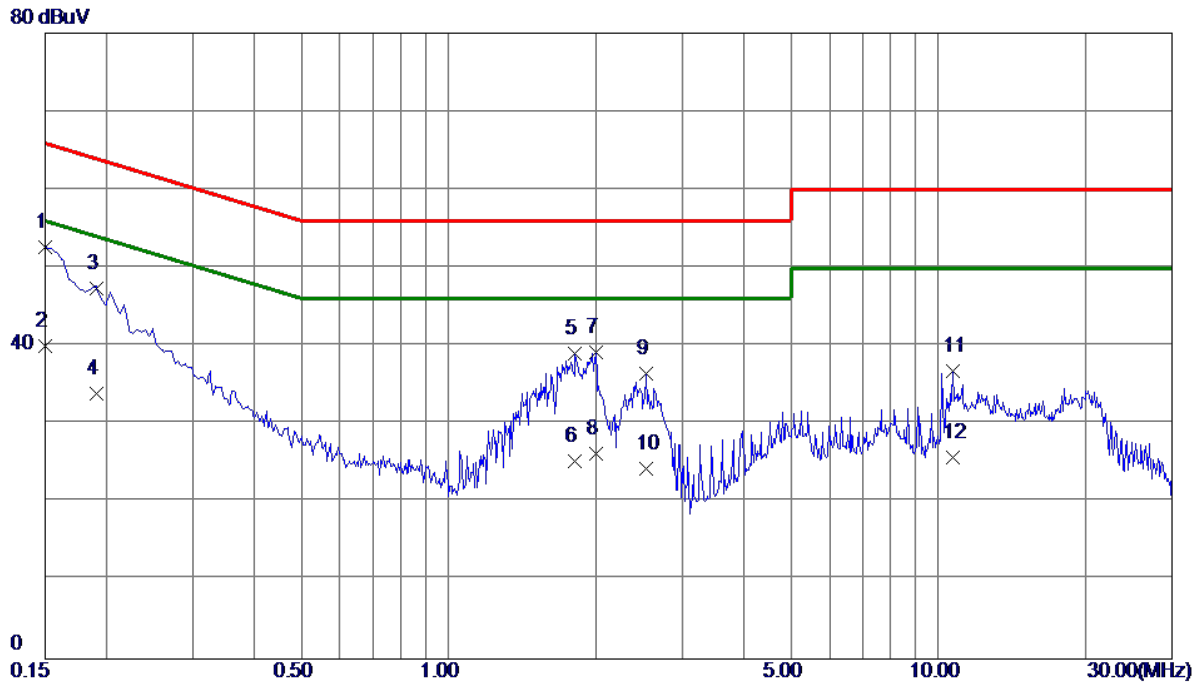

No.	Freq. MHz	Reading Level dBuV	Correct Factor dB	Measure ment dBuV	Limit dBuV	Margin dB	Detector
1 *	0.1500	42.75	9.82	52.57	66.00	-13.43	QP
2	0.1500	30.20	9.82	40.02	56.00	-15.98	AVG
3	0.1914	37.58	9.83	47.41	63.98	-16.57	QP
4	0.1914	24.10	9.83	33.93	53.98	-20.05	AVG
5	1.8105	29.10	10.01	39.11	56.00	-16.89	QP
6	1.8105	15.31	10.01	25.32	46.00	-20.68	AVG
7	1.9950	29.12	10.03	39.15	56.00	-16.85	QP
8	1.9950	16.20	10.03	26.23	46.00	-19.77	AVG
9	2.5350	26.43	10.07	36.50	56.00	-19.50	QP
10	2.5350	14.20	10.07	24.27	46.00	-21.73	AVG
11	10.6889	26.23	10.57	36.80	60.00	-23.20	QP
12	10.6889	15.21	10.57	25.78	50.00	-24.22	AVG

Test Voltage	AC 120V/60Hz	Phase	Neutral
Test Mode	HDMI 1920*1080/75Hz 1.8m H		
Model	27P2Q		

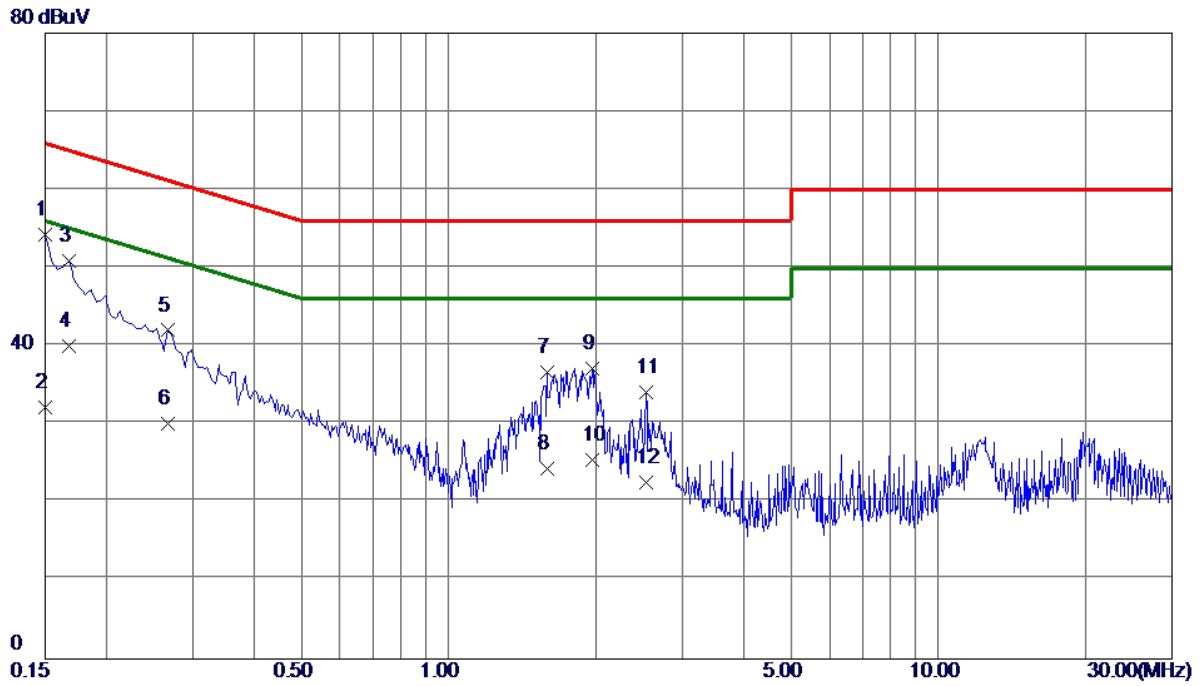

No.	Freq. MHz	Reading Level dBuV	Correct Factor dB	Measure ment dBuV	Limit dBuV	Margin dB	Detector
1 *	0.1500	44.31	9.91	54.22	66.00	-11.78	QP
2	0.1500	22.30	9.91	32.21	56.00	-23.79	AVG
3	0.1680	40.90	9.92	50.82	65.06	-14.24	QP
4	0.1680	30.10	9.92	40.02	55.06	-15.04	AVG
5	0.2670	32.05	9.95	42.00	61.21	-19.21	QP
6	0.2670	20.11	9.95	30.06	51.21	-21.15	AVG
7	1.5855	26.50	10.19	36.69	56.00	-19.31	QP
8	1.5855	14.20	10.19	24.39	46.00	-21.61	AVG
9	1.9635	26.92	10.22	37.14	56.00	-18.86	QP
10	1.9635	15.20	10.22	25.42	46.00	-20.58	AVG
11	2.5260	23.81	10.26	34.07	56.00	-21.93	QP
12	2.5260	12.30	10.26	22.56	46.00	-23.44	AVG

Test Voltage	AC 120V/60Hz	Phase	Line
Test Mode	D-SUB 1920*1080/60Hz 1.8m H		
Model	27P2Q		

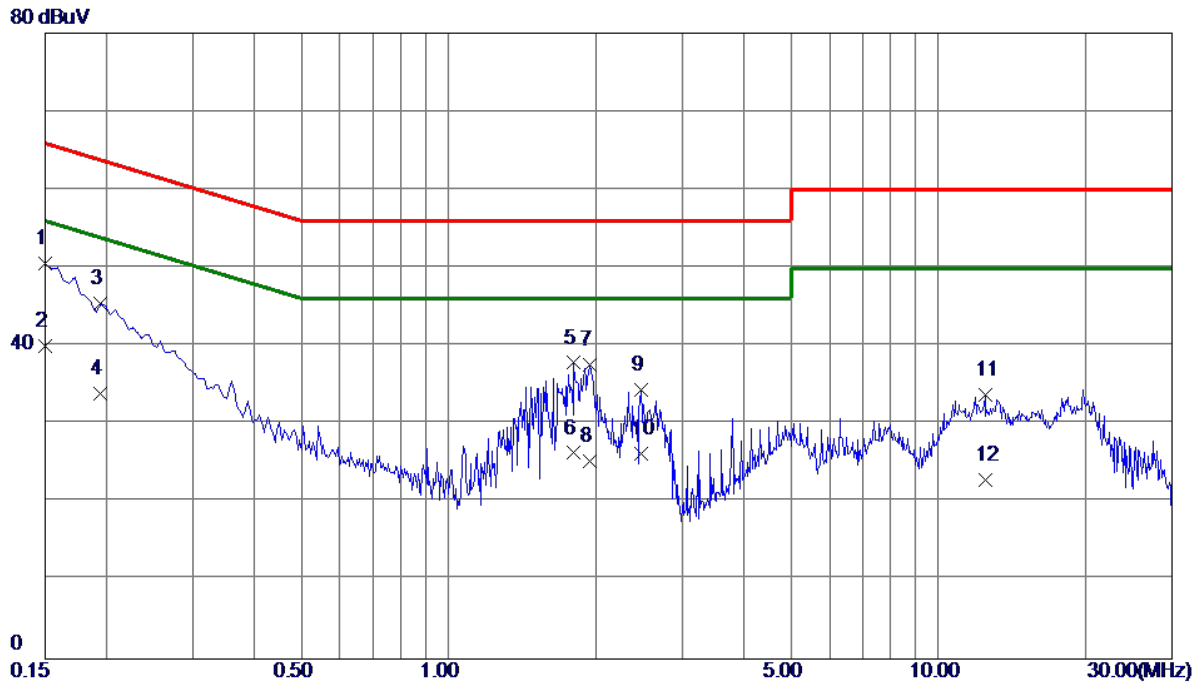

No.	Freq. MHz	Reading Level dBuV	Correct Factor dB	Measure ment dBuV	Limit dBuV	Margin dB	Detector
1 *	0.1500	40.67	9.82	50.49	66.00	-15.51	QP
2	0.1500	30.20	9.82	40.02	56.00	-15.98	AVG
3	0.1949	35.57	9.83	45.40	63.83	-18.43	QP
4	0.1949	24.10	9.83	33.93	53.83	-19.90	AVG
5	1.8015	27.83	10.01	37.84	56.00	-18.16	QP
6	1.8015	16.31	10.01	26.32	46.00	-19.68	AVG
7	1.9455	27.64	10.02	37.66	56.00	-18.34	QP
8	1.9455	15.21	10.02	25.23	46.00	-20.77	AVG
9	2.4675	24.33	10.06	34.39	56.00	-21.61	QP
10	2.4675	16.20	10.06	26.26	46.00	-19.74	AVG
11	12.4485	23.09	10.66	33.75	60.00	-26.25	QP
12	12.4485	12.20	10.66	22.86	50.00	-27.14	AVG

Test Voltage	AC 120V/60Hz	Phase	Neutral
Test Mode	D-SUB 1920*1080/60Hz 1.8m H		
Model	27P2Q		

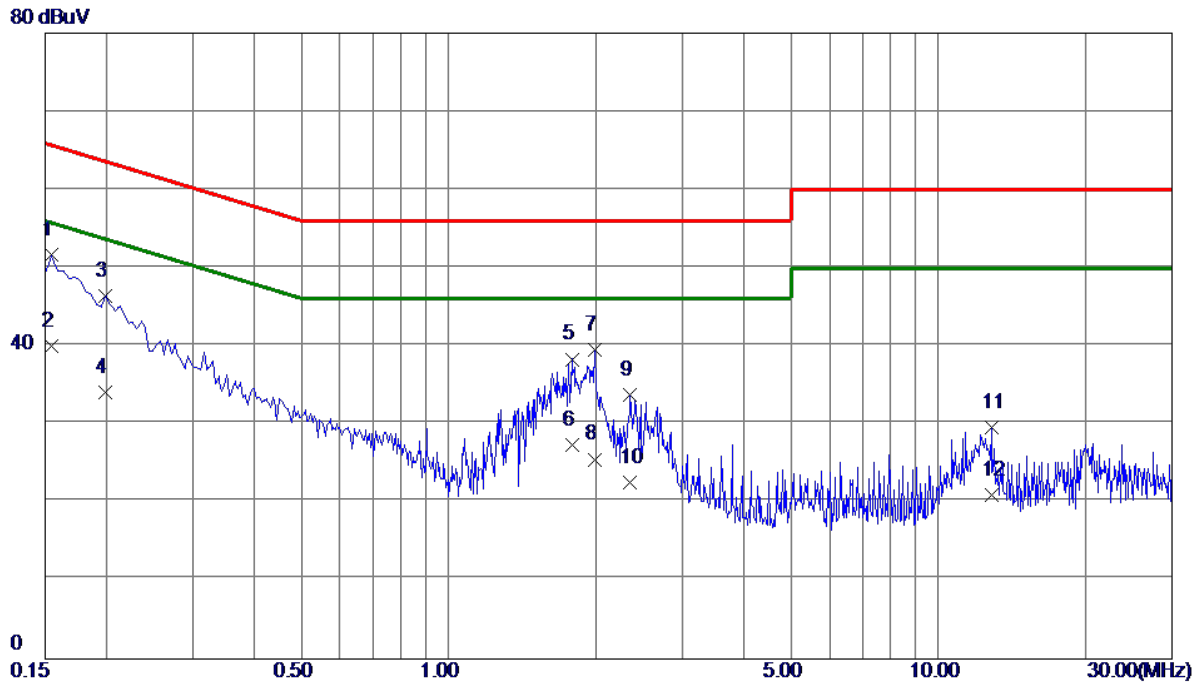

No.	Freq. MHz	Reading Level dBuV	Correct Factor dB	Measure ment dBuV	Limit dBuV	Margin dB	Detector
1 *	0.1545	41.76	9.91	51.67	65.75	-14.08	QP
2	0.1545	30.10	9.91	40.01	55.75	-15.74	AVG
3	0.1995	36.55	9.92	46.47	63.63	-17.16	QP
4	0.1995	24.10	9.92	34.02	53.63	-19.61	AVG
5	1.7880	28.11	10.21	38.32	56.00	-17.68	QP
6	1.7880	17.20	10.21	27.41	46.00	-18.59	AVG
7	1.9860	29.34	10.22	39.56	56.00	-16.44	QP
8	1.9860	15.30	10.22	25.52	46.00	-20.48	AVG
9	2.3505	23.51	10.24	33.75	56.00	-22.25	QP
10	2.3505	12.30	10.24	22.54	46.00	-23.46	AVG
11	12.8220	18.67	10.98	29.65	60.00	-30.35	QP
12	12.8220	10.00	10.98	20.98	50.00	-29.02	AVG

Test Voltage	AC 120V/60Hz	Phase	Line
Test Mode	HDMI 1080P 1.8m H		
Model	27P2Q		

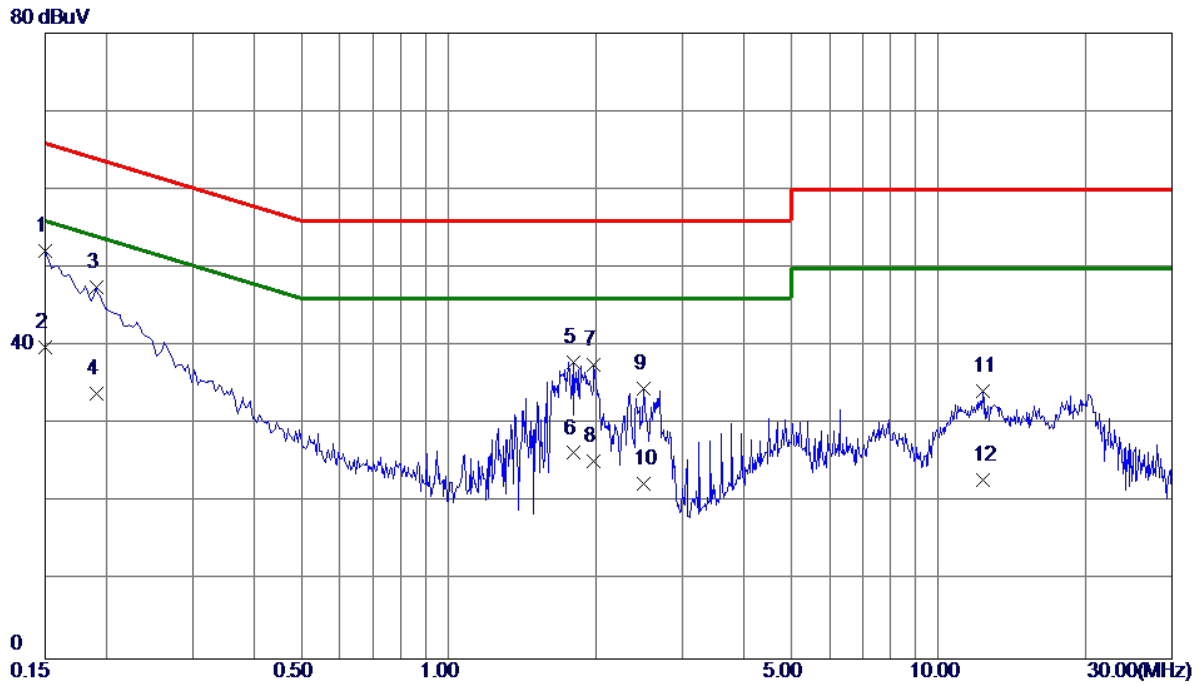

No.	Freq. MHz	Reading Level dBuV	Correct Factor dB	Measure ment dBuV	Limit dBuV	Margin dB	Detector
1 *	0.1500	42.30	9.82	52.12	66.00	-13.88	QP
2	0.1500	30.10	9.82	39.92	56.00	-16.08	AVG
3	0.1905	37.63	9.83	47.46	64.01	-16.55	QP
4	0.1905	24.10	9.83	33.93	54.01	-20.08	AVG
5	1.8015	27.93	10.01	37.94	56.00	-18.06	QP
6	1.8015	16.31	10.01	26.32	46.00	-19.68	AVG
7	1.9815	27.60	10.03	37.63	56.00	-18.37	QP
8	1.9815	15.20	10.03	25.23	46.00	-20.77	AVG
9	2.5035	24.49	10.07	34.56	56.00	-21.44	QP
10	2.5035	12.30	10.07	22.37	46.00	-23.63	AVG
11	12.3135	23.54	10.66	34.20	60.00	-25.80	QP
12	12.3135	12.29	10.66	22.95	50.00	-27.05	AVG

Test Voltage	AC 120V/60Hz	Phase	Neutral
Test Mode	HDMI 1080P 1.8m H		
Model	27P2Q		

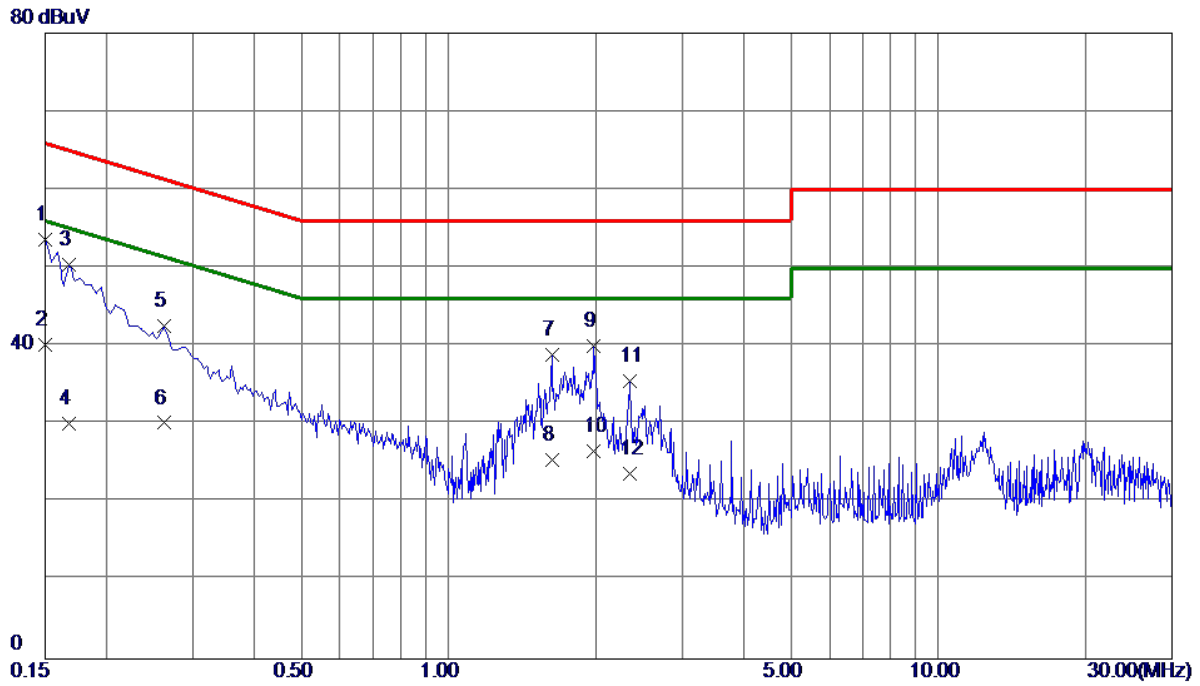

No.	Freq. MHz	Reading Level dBuV	Correct Factor dB	Measure ment dBuV	Limit dBuV	Margin dB	Detector
1 *	0.1500	43.68	9.91	53.59	66.00	-12.41	QP
2	0.1500	30.20	9.91	40.11	56.00	-15.89	AVG
3	0.1680	40.50	9.92	50.42	65.06	-14.64	QP
4	0.1680	20.20	9.92	30.12	55.06	-24.94	AVG
5	0.2625	32.56	9.95	42.51	61.35	-18.84	QP
6	0.2625	20.21	9.95	30.16	51.35	-21.19	AVG
7	1.6260	28.73	10.19	38.92	56.00	-17.08	QP
8	1.6260	15.20	10.19	25.39	46.00	-20.61	AVG
9	1.9815	29.76	10.22	39.98	56.00	-16.02	QP
10	1.9815	16.30	10.22	26.52	46.00	-19.48	AVG
11	2.3415	25.27	10.24	35.51	56.00	-20.49	QP
12	2.3415	13.40	10.24	23.64	46.00	-22.36	AVG

Test Voltage	AC 120V/60Hz	Phase	Line
Test Mode	HDMI 1920*1080/75Hz 1.8m V		
Model	27P2U		

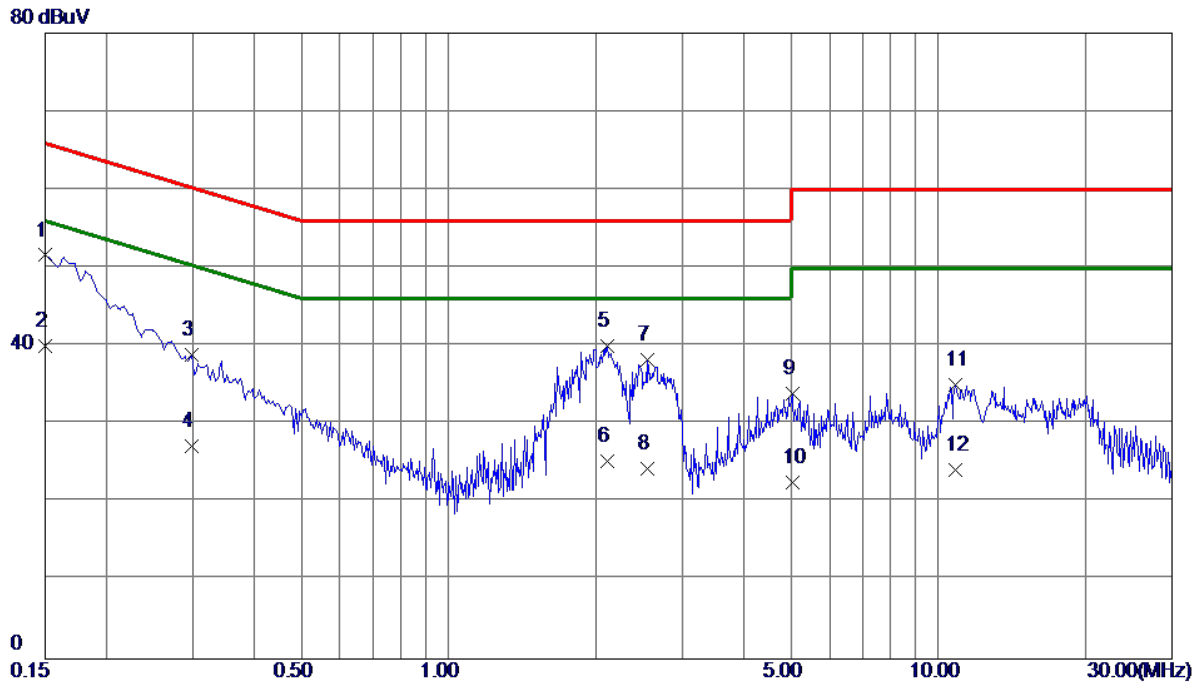

No.	Freq. MHz	Reading Level dBuV	Correct Factor dB	Measure ment dBuV	Limit dBuV	Margin dB	Detector
1 *	0.1500	41.78	9.82	51.60	66.00	-14.40	QP
2	0.1500	30.20	9.82	40.02	56.00	-15.98	AVG
3	0.2985	29.01	9.86	38.87	60.28	-21.41	QP
4	0.2985	17.30	9.86	27.16	50.28	-23.12	AVG
5	2.1030	29.96	10.04	40.00	56.00	-16.00	QP
6	2.1030	15.30	10.04	25.34	46.00	-20.66	AVG
7	2.5395	28.13	10.07	38.20	56.00	-17.80	QP
8	2.5395	14.20	10.07	24.27	46.00	-21.73	AVG
9	5.0280	23.75	10.24	33.99	60.00	-26.01	QP
10	5.0280	12.30	10.24	22.54	50.00	-27.46	AVG
11	10.8060	24.50	10.58	35.08	60.00	-24.92	QP
12	10.8060	13.60	10.58	24.18	50.00	-25.82	AVG

Test Voltage	AC 120V/60Hz	Phase	Neutral
Test Mode	HDMI 1920*1080/75Hz 1.8m V		
Model	27P2U		

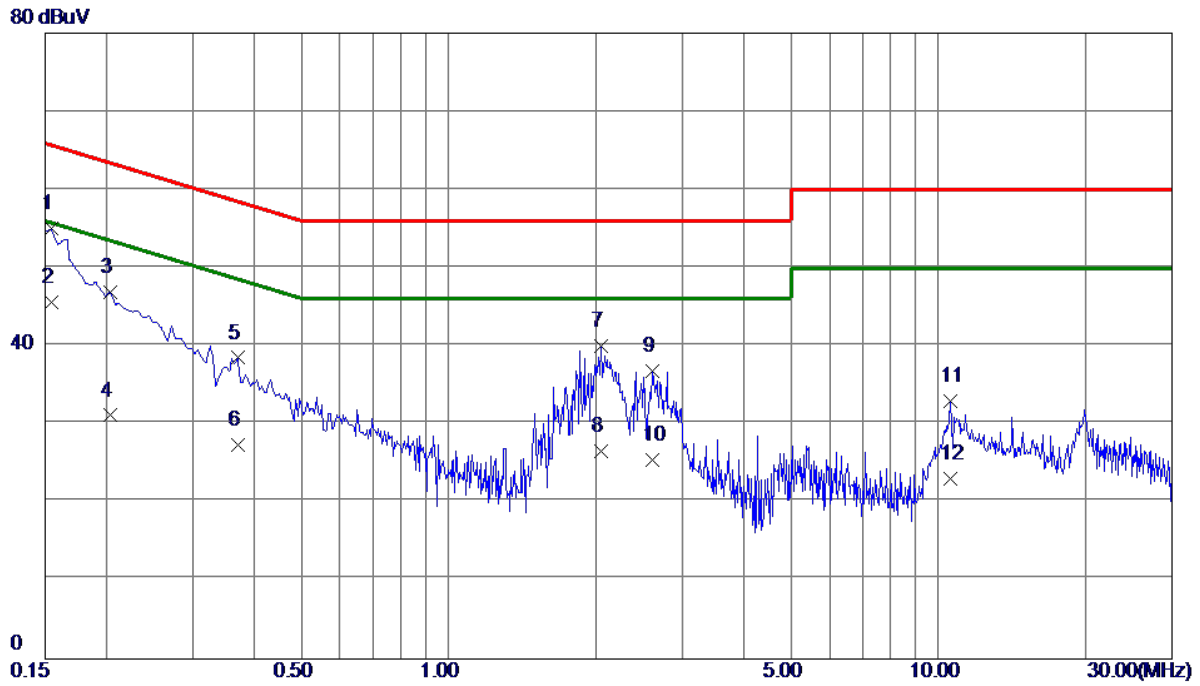

No.	Freq. MHz	Reading Level dBuV	Correct Factor dB	Measure ment dBuV	Limit dBuV	Margin dB	Detector
1	0.1544	45.16	9.91	55.07	65.76	-10.69	QP
2 *	0.1544	35.71	9.91	45.62	55.76	-10.14	AVG
3	0.2040	37.03	9.92	46.95	63.45	-16.50	QP
4	0.2040	21.20	9.92	31.12	53.45	-22.33	AVG
5	0.3704	28.46	10.02	38.48	58.49	-20.01	QP
6	0.3704	17.29	10.02	27.31	48.49	-21.18	AVG
7	2.0490	29.72	10.22	39.94	56.00	-16.06	QP
8	2.0490	16.30	10.22	26.52	46.00	-19.48	AVG
9	2.6115	26.52	10.26	36.78	56.00	-19.22	QP
10	2.6115	15.20	10.26	25.46	46.00	-20.54	AVG
11	10.6080	22.06	10.83	32.89	60.00	-27.11	QP
12	10.6080	12.20	10.83	23.03	50.00	-26.97	AVG

Test Voltage	AC 120V/60Hz	Phase	Line
Test Mode	D-SUB 1920*1080/60Hz 1.8m V		
Model	27P2U		

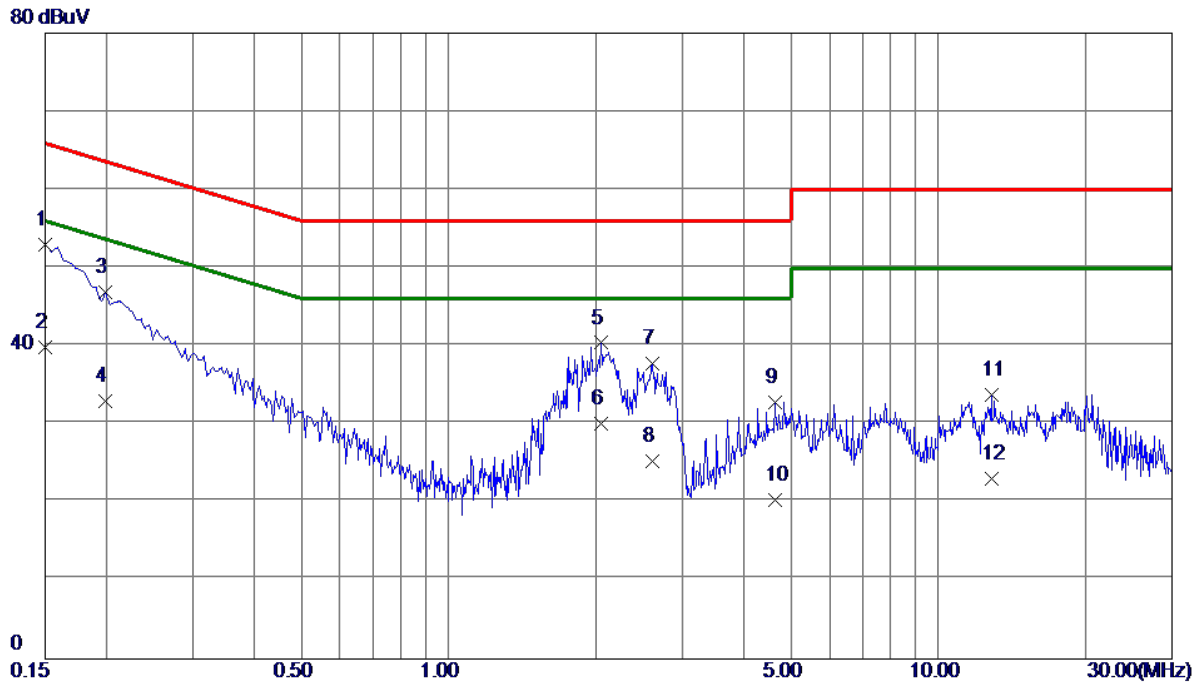

No.	Freq. MHz	Reading Level dBuV	Correct Factor dB	Measure ment dBuV	Limit dBuV	Margin dB	Detector
1 *	0.1500	43.21	9.82	53.03	66.00	-12.97	QP
2	0.1500	30.10	9.82	39.92	56.00	-16.08	AVG
3	0.1995	37.00	9.83	46.83	63.63	-16.80	QP
4	0.1995	23.20	9.83	33.03	53.63	-20.60	AVG
5	2.0490	30.37	10.03	40.40	56.00	-15.60	QP
6	2.0490	20.10	10.03	30.13	46.00	-15.87	AVG
7	2.6070	27.76	10.07	37.83	56.00	-18.17	QP
8	2.6070	15.20	10.07	25.27	46.00	-20.73	AVG
9	4.6455	22.60	10.22	32.82	56.00	-23.18	QP
10	4.6455	10.10	10.22	20.32	46.00	-25.68	AVG
11	12.8265	23.13	10.68	33.81	60.00	-26.19	QP
12	12.8265	12.30	10.68	22.98	50.00	-27.02	AVG

Test Voltage	AC 120V/60Hz	Phase	Neutral
Test Mode	D-SUB 1920*1080/60Hz 1.8m V		
Model	27P2U		

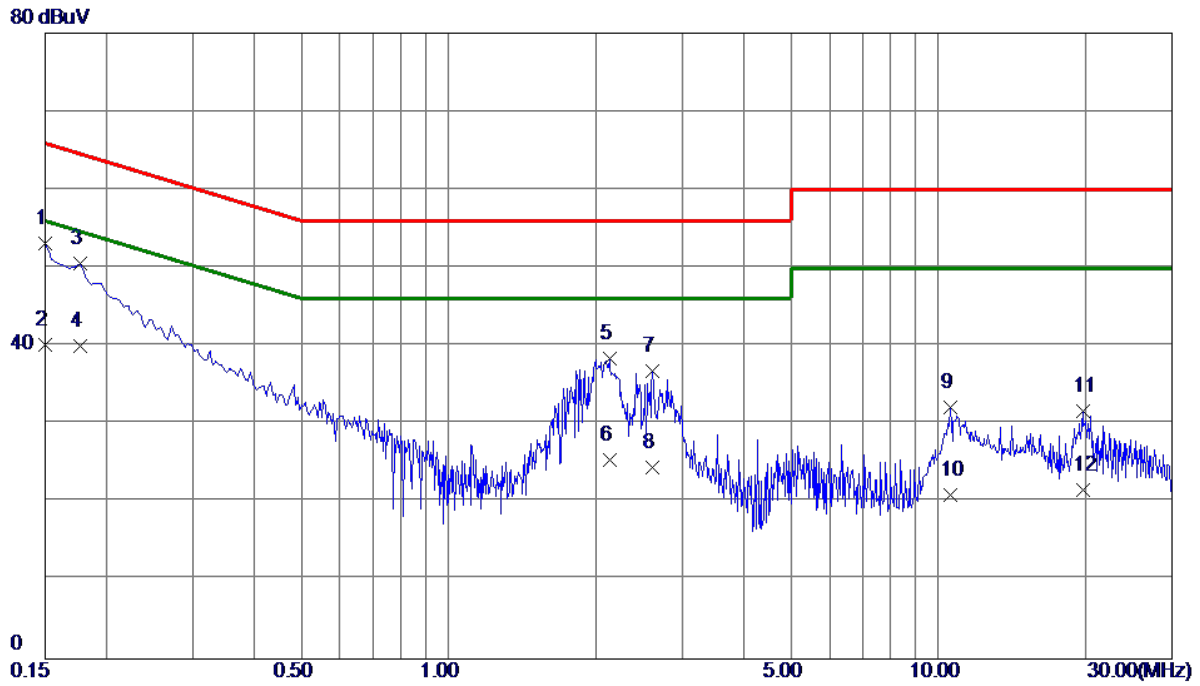

No.	Freq. MHz	Reading Level dBuV	Correct Factor dB	Measure ment dBuV	Limit dBuV	Margin dB	Detector
1 *	0.1500	43.28	9.91	53.19	66.00	-12.81	QP
2	0.1500	30.20	9.91	40.11	56.00	-15.89	AVG
3	0.1770	40.60	9.92	50.52	64.63	-14.11	QP
4	0.1770	30.10	9.92	40.02	54.63	-14.61	AVG
5	2.1300	28.10	10.23	38.33	56.00	-17.67	QP
6	2.1300	15.20	10.23	25.43	46.00	-20.57	AVG
7	2.6115	26.48	10.26	36.74	56.00	-19.26	QP
8	2.6115	14.20	10.26	24.46	46.00	-21.54	AVG
9	10.6035	21.32	10.83	32.15	60.00	-27.85	QP
10	10.6035	10.10	10.83	20.93	50.00	-29.07	AVG
11	19.7115	20.13	11.49	31.62	60.00	-28.38	QP
12	19.7115	10.09	11.49	21.58	50.00	-28.42	AVG

Test Voltage	AC 120V/60Hz	Phase	Line
Test Mode	HDMI 1080P 1.8m V		
Model	27P2U		

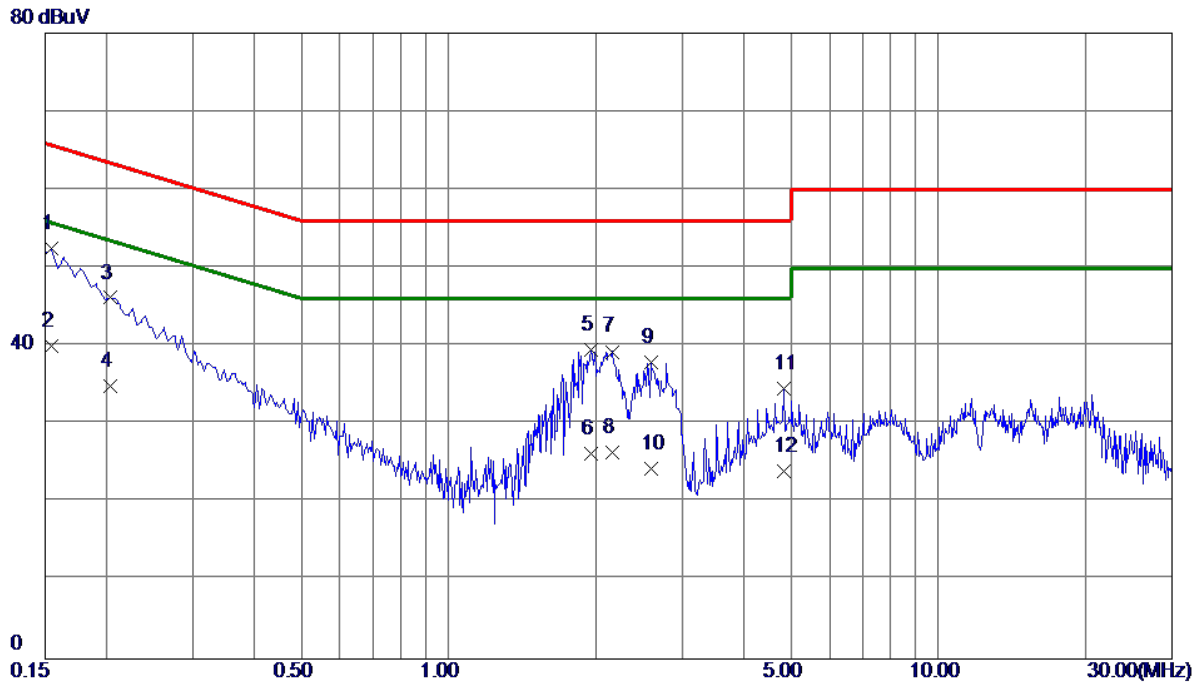

No.	Freq. MHz	Reading Level dBuV	Correct Factor dB	Measure ment dBuV	Limit dBuV	Margin dB	Detector
1 *	0.1545	42.70	9.82	52.52	65.75	-13.23	QP
2	0.1545	30.20	9.82	40.02	55.75	-15.73	AVG
3	0.2040	36.33	9.83	46.16	63.45	-17.29	QP
4	0.2040	25.10	9.83	34.93	53.45	-18.52	AVG
5	1.9545	29.43	10.03	39.46	56.00	-16.54	QP
6	1.9545	16.20	10.03	26.23	46.00	-19.77	AVG
7	2.1570	29.24	10.04	39.28	56.00	-16.72	QP
8	2.1570	16.30	10.04	26.34	46.00	-19.66	AVG
9	2.5935	27.89	10.07	37.96	56.00	-18.04	QP
10	2.5935	14.20	10.07	24.27	46.00	-21.73	AVG
11	4.8300	24.38	10.23	34.61	56.00	-21.39	QP
12	4.8300	13.70	10.23	23.93	46.00	-22.07	AVG

Test Voltage	AC 120V/60Hz	Phase	Neutral
Test Mode	HDMI 1080P 1.8m V		
Model	27P2U		

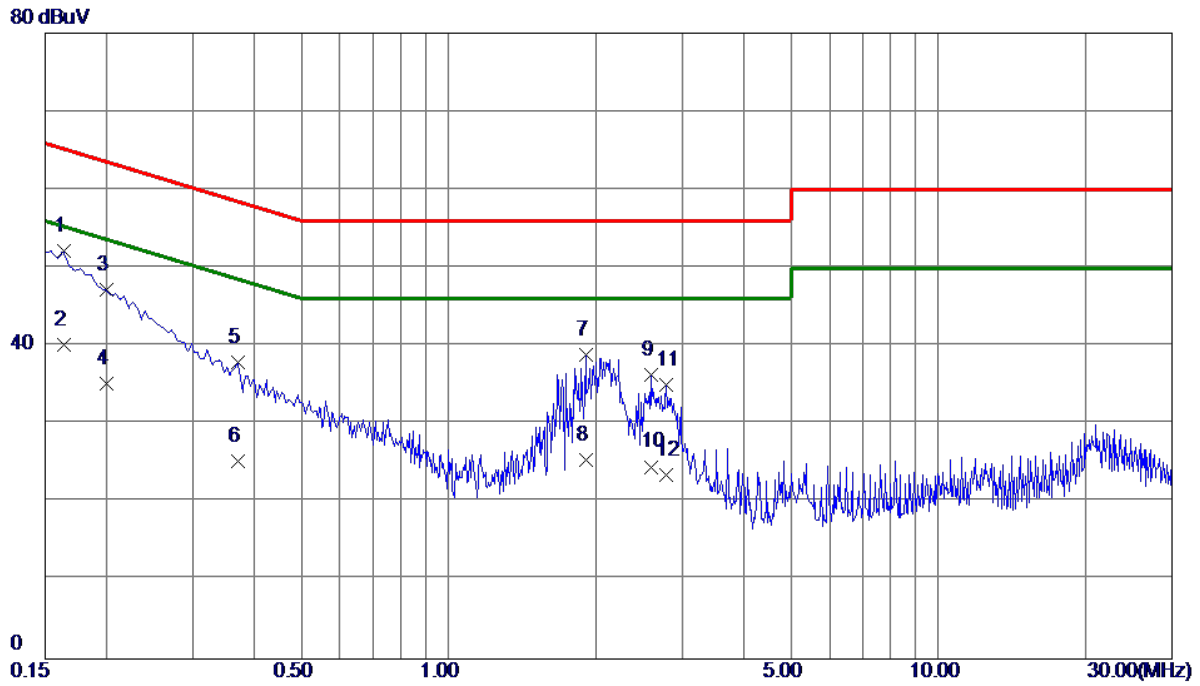

No.	Freq. MHz	Reading Level dBuV	Correct Factor dB	Measure ment dBuV	Limit dBuV	Margin dB	Detector
1 *	0.1635	42.25	9.92	52.17	65.28	-13.11	QP
2	0.1635	30.20	9.92	40.12	55.28	-15.16	AVG
3	0.1997	37.30	9.92	47.22	63.62	-16.40	QP
4	0.1997	25.30	9.92	35.22	53.62	-18.40	AVG
5	0.3704	27.94	10.02	37.96	58.49	-20.53	QP
6	0.3704	15.19	10.02	25.21	48.49	-23.28	AVG
7	1.9050	28.69	10.21	38.90	56.00	-17.10	QP
8	1.9050	15.20	10.21	25.41	46.00	-20.59	AVG
9	2.5935	26.00	10.26	36.26	56.00	-19.74	QP
10	2.5935	14.30	10.26	24.56	46.00	-21.44	AVG
11	2.7825	24.73	10.28	35.01	56.00	-20.99	QP
12	2.7825	13.20	10.28	23.48	46.00	-22.52	AVG

3.2 RADIATED EMISSIONS 30 MHZ TO 1 GHZ

3.2.1 LIMIT

Frequency (MHz)	Class B (at 3m)	
	(uV/m) Field strength	(dBuV/m) Field strength
30 - 88	100	40
88 - 216	150	43.5
216 - 960	200	46
Above 960	500	54

NOTE:

- (1) The tighter limit applies at the band edges.
- (2) Emission level (dBuV/m) = $20\log$ Emission level (uV/m).
3m Emission level = 10m Emission level + $20\log(10m/3m)$.
- (3) The test result calculated as following:
Measurement Value = Reading Level + Correct Factor
Correct Factor = Antenna Factor + Cable Loss - Amplifier Gain(if use)
Margin Level = Measurement Value - Limit Value

3.2.2 MEASUREMENT INSTRUMENTS LIST

Item	Kind of Equipment	Manufacturer	Type No.	Serial No.	Calibrated until
1	Receiver	Keysight	N9038A	MY54450004	Aug. 03, 2020
2	Pre-Amplifier	EMC INSTRUMENT	EMC 9135	980284	Mar. 01, 2021
3	Trilog-Broadband Antenna	Schwarzbeck	VULB9168	946	Oct. 26, 2020
4	Cable	emci	LMR-400(5m+11m+15m)	N/A	Nov. 22, 2020
5	Measurement Software	Farad	EZ-EMC Ver.BTL-2ANT-1	N/A	N/A
6	Multi-Device Controller	ETS-Lindgren	2090	N/A	N/A
7	Attenuator	EMCI	EMCI-N-6-06	N0670	Dec. 02, 2020

Remark: "N/A" denotes no model name, no serial no. or no calibration specified.

All calibration period of equipment list is one year.

3.2.3 TEST PROCEDURE

- The measuring distance of 3 m shall be used for measurements. The EUT was placed on the top of a rotating table 0.8 meter above the ground at a 10 meter semi-anechoic chamber. The table was rotated 360 degrees to determine the position of the highest radiation.
- The height of the equipment or of the substitution antenna shall be 0.8 m, the height of the test antenna shall vary between 1 m to 4 m. Both horizontal and vertical polarizations of the antenna are set to make the measurement.
- For each suspected emission, the EUT was arranged to its worst case and then the antenna was tuned to heights find the maximum reading (used Bore sight function).
- The initial step in collecting radiated emission data is a receiver peak detector mode pre-scanning the measurement frequency range. Significant peaks are then marked and then Quasi Peak detector mode re-measured.
- All readings are Peak unless otherwise stated QP in column of Note. Peak denotes that the Peak reading compliance with the QP Limits and then QP Mode measurement didn't perform.
- For the actual test configuration, please refer to the related Item - Block Diagram of system tested.

3.2.4 DEVIATION FROM TEST STANDARD

No deviation

3.2.5 TEST SETUP

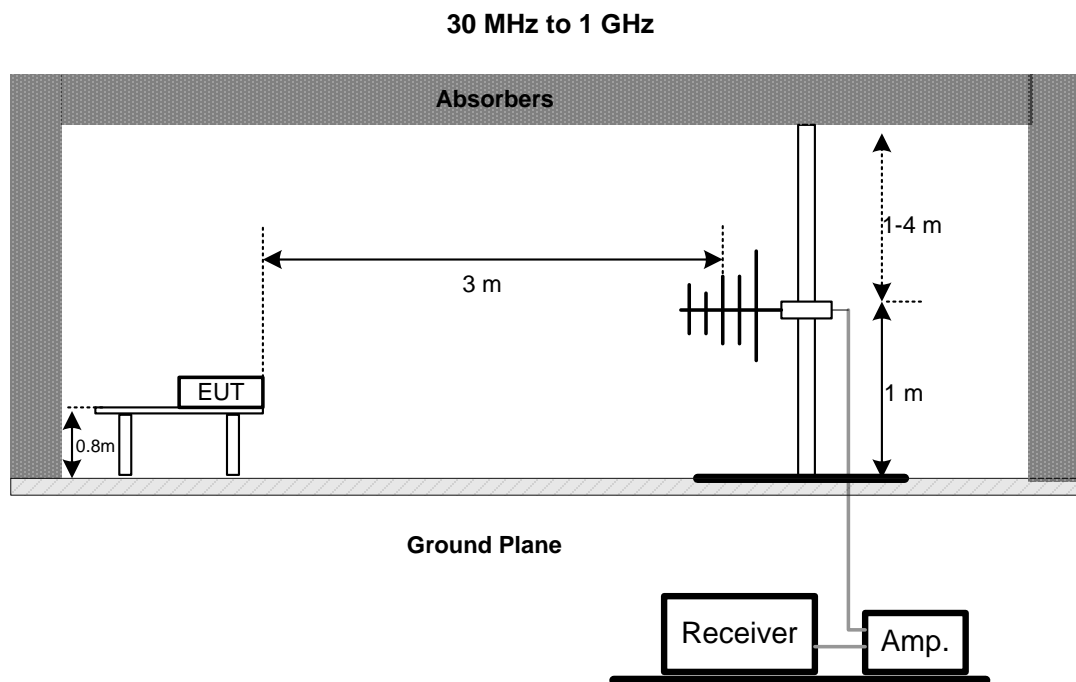

3.2.6 TEST RESULTS

Remark :

- Measuring frequency range from 30 MHz to 1000 MHz
- If the peak scan value lower limit more than 20 dB, then this signal data does not show in table.

Test Voltage	AC 120V/60Hz	Polarization	Vertical
Test Mode	HDMI 1920*1080/75Hz 1.8m H		
Model	27P2Q		

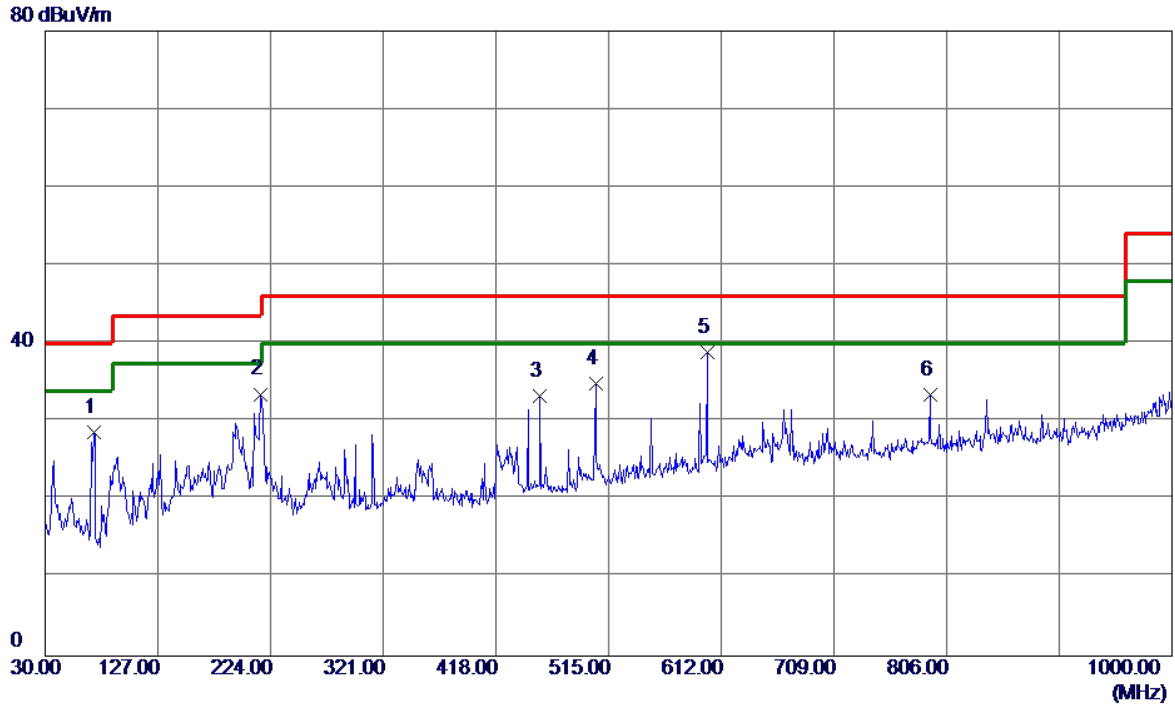

No.	Freq. MHz	Reading Level dBuV/m	Correct Factor dB	Measure ment dBuV/m	Limit dBuV/m	Margin dB	Detector
1	72.1950	46.84	-18.25	28.59	40.00	-11.41	QP
2	215.7550	50.17	-16.65	33.52	43.50	-9.98	QP
3	455.8300	42.38	-9.03	33.35	46.00	-12.65	QP
4	503.8450	43.26	-8.44	34.82	46.00	-11.18	QP
5 *	599.8750	45.21	-6.32	38.89	46.00	-7.11	QP
6	791.9350	36.85	-3.37	33.48	46.00	-12.52	QP

Test Voltage	AC 120V/60Hz	Polarization	Horizontal
Test Mode	HDMI 1920*1080/75Hz 1.8m H		
Model	27P2Q		

80 dBuV/m

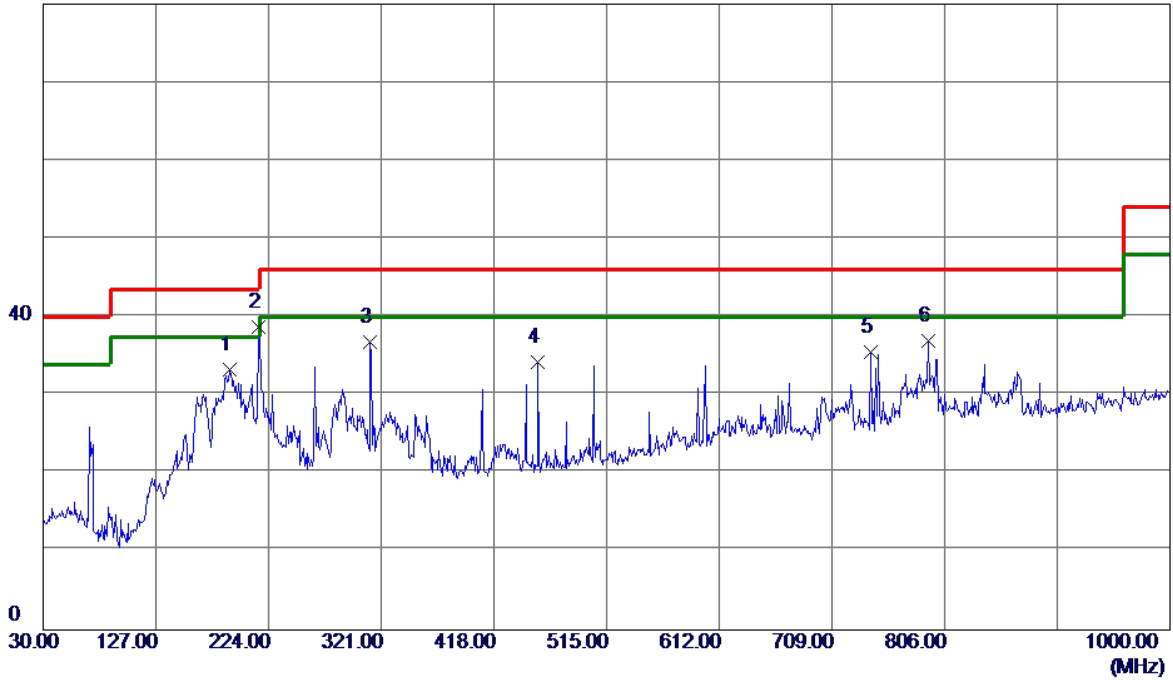

No.	Freq. MHz	Reading Level dBuV/m	Correct Factor dB	Measure ment dBuV/m	Limit dBuV/m	Margin dB	Detector
1	190.5350	50.10	-16.76	33.34	43.50	-10.16	QP
2 *	215.7550	55.30	-16.65	38.65	43.50	-4.85	QP
3	311.7850	49.52	-12.73	36.79	46.00	-9.21	QP
4	455.8300	43.23	-9.03	34.20	46.00	-11.80	QP
5	742.4650	39.51	-3.98	35.53	46.00	-10.47	QP
6	791.9350	40.37	-3.37	37.00	46.00	-9.00	QP

Test Voltage	AC 120V/60Hz	Polarization	Vertical
Test Mode	D-SUB 1920*1080/60Hz 1.8m H		
Model	27P2Q		

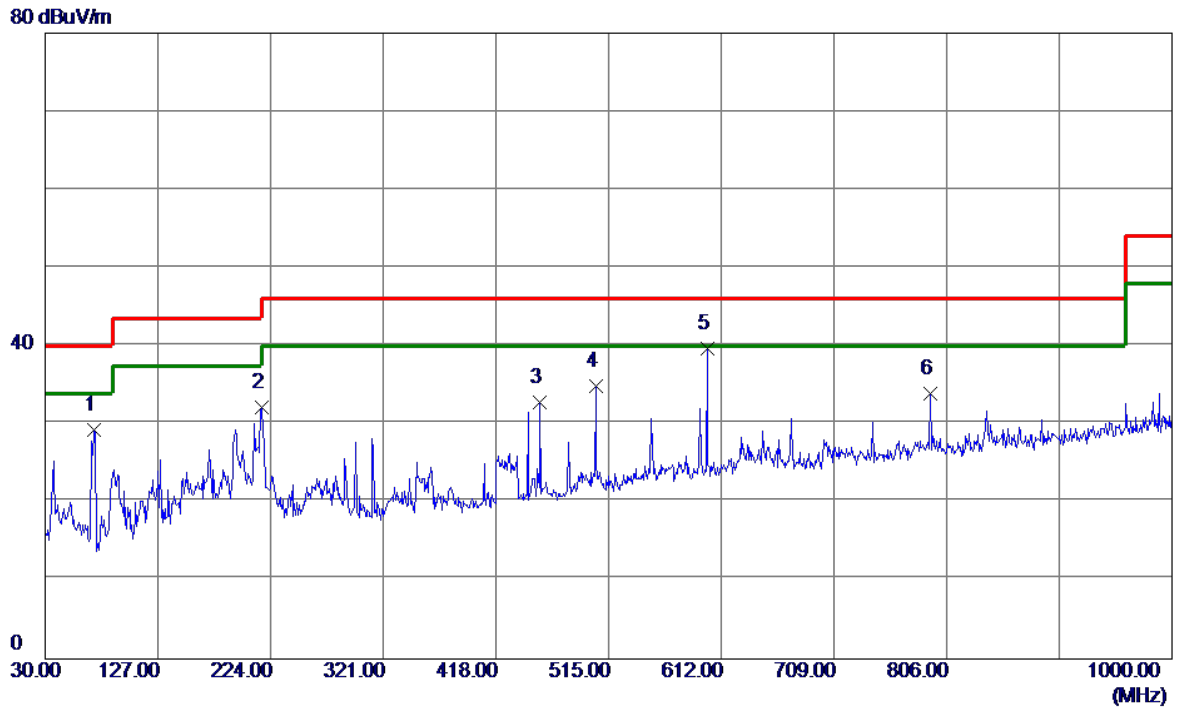

No.	Freq. MHz	Reading Level dBuV/m	Correct Factor dB	Measure ment dBuV/m	Limit dBuV/m	Margin dB	Detector
1	72.1950	47.48	-18.25	29.23	40.00	-10.77	QP
2	216.2400	48.84	-16.64	32.20	46.00	-13.80	QP
3	455.8300	41.82	-9.03	32.79	46.00	-13.21	QP
4	503.8450	43.36	-8.44	34.92	46.00	-11.08	QP
5 *	599.8750	45.94	-6.32	39.62	46.00	-6.38	QP
6	791.9350	37.31	-3.37	33.94	46.00	-12.06	QP

Test Voltage	AC 120V/60Hz	Polarization	Horizontal
Test Mode	D-SUB 1920*1080/60Hz 1.8m H		
Model	27P2Q		

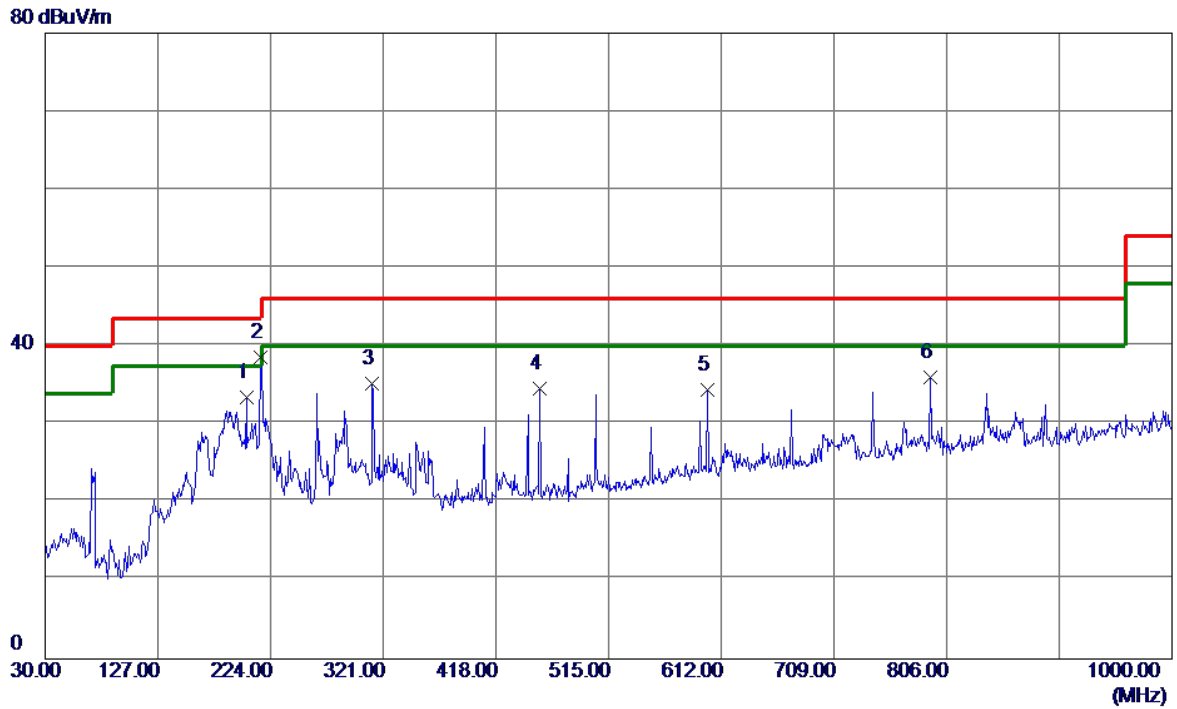

No.	Freq. MHz	Reading Level dBuV/m	Correct Factor dB	Measure ment dBuV/m	Limit dBuV/m	Margin dB	Detector
1	203.1450	50.36	-16.93	33.43	43.50	-10.07	QP
2 *	215.7550	55.20	-16.65	38.55	43.50	-4.95	QP
3	311.7850	47.97	-12.73	35.24	46.00	-10.76	QP
4	455.8300	43.64	-9.03	34.61	46.00	-11.39	QP
5	599.8750	40.71	-6.32	34.39	46.00	-11.61	QP
6	791.9350	39.42	-3.37	36.05	46.00	-9.95	QP

Test Voltage	AC 120V/60Hz	Polarization	Vertical
Test Mode	HDMI 1080P 1.8m H		
Model	27P2Q		

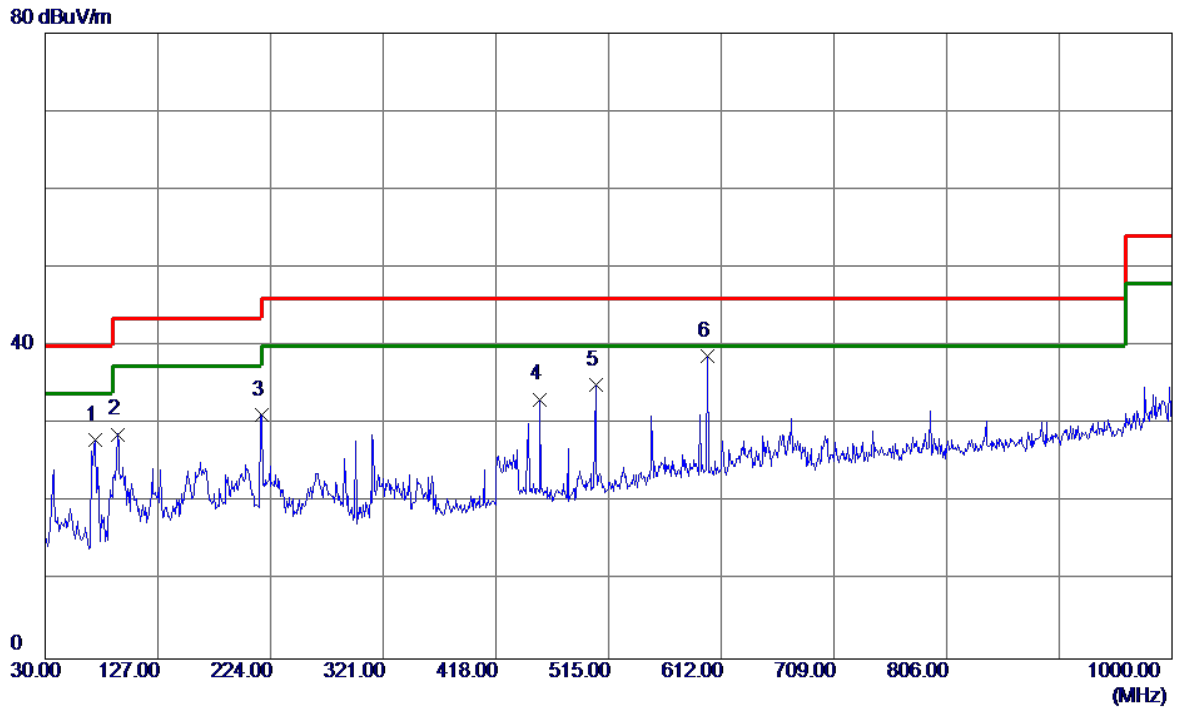

No.	Freq. MHz	Reading Level dBuV/m	Correct Factor dB	Measure ment dBuV/m	Limit dBuV/m	Margin dB	Detector
1	72.6800	46.35	-18.35	28.00	40.00	-12.00	QP
2	92.5650	49.73	-21.01	28.72	43.50	-14.78	QP
3	216.2400	47.85	-16.64	31.21	46.00	-14.79	QP
4	455.8300	42.23	-9.03	33.20	46.00	-12.80	QP
5	503.8450	43.50	-8.44	35.06	46.00	-10.94	QP
6 *	599.8750	45.00	-6.32	38.68	46.00	-7.32	QP

Test Voltage	AC 120V/60Hz	Polarization	Horizontal
Test Mode	HDMI 1080P 1.8m H		
Model	27P2Q		

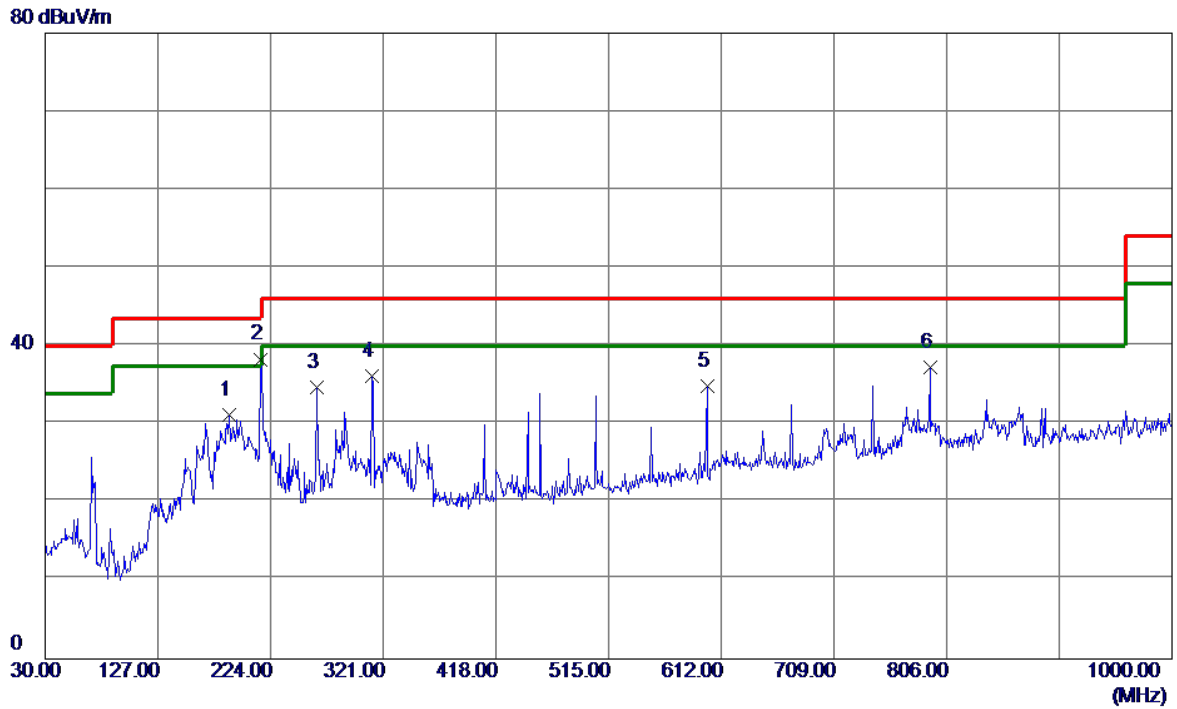

No.	Freq. MHz	Reading Level dBuV/m	Correct Factor dB	Measure ment dBuV/m	Limit dBuV/m	Margin dB	Detector
1	188.5950	47.81	-16.62	31.19	43.50	-12.31	QP
2 *	215.7550	54.97	-16.65	38.32	43.50	-5.18	QP
3	263.7700	49.25	-14.59	34.66	46.00	-11.34	QP
4	311.7850	48.88	-12.73	36.15	46.00	-9.85	QP
5	599.8750	41.24	-6.32	34.92	46.00	-11.08	QP
6	791.9350	40.69	-3.37	37.32	46.00	-8.68	QP

Test Voltage	AC 120V/60Hz	Polarization	Vertical
Test Mode	HDMI 1920*1080/75Hz 1.8m V		
Model	27P2U		

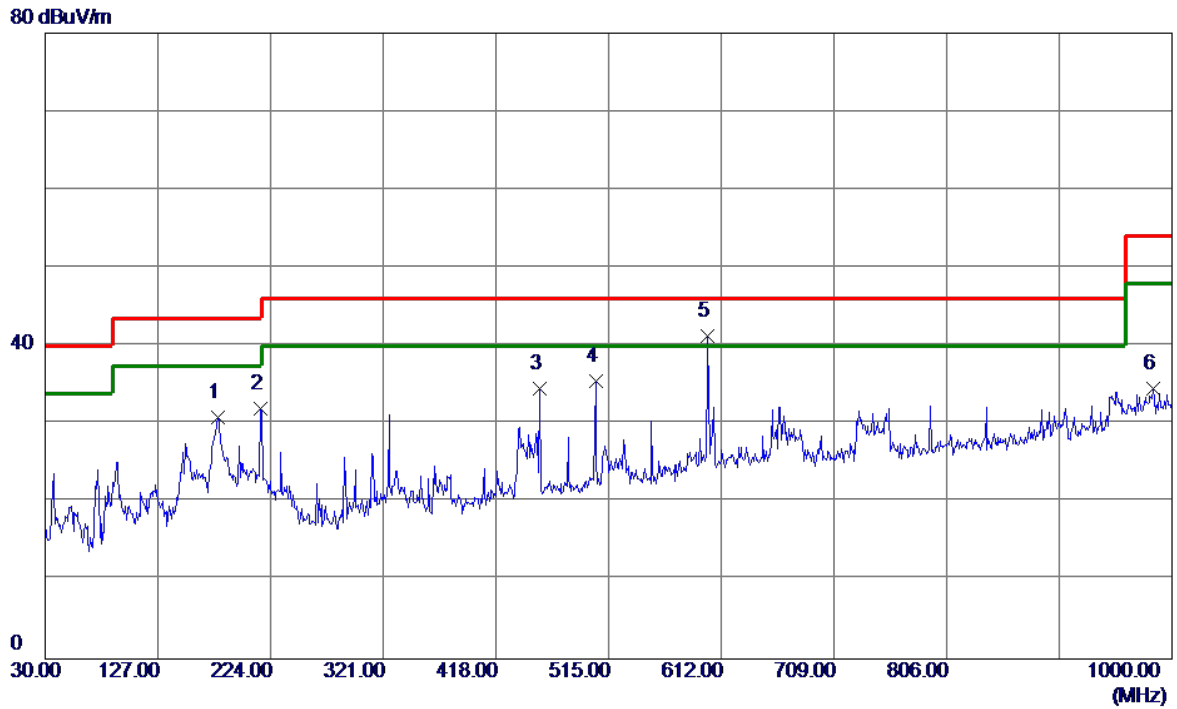

No.	Freq. MHz	Reading Level dBuV/m	Correct Factor dB	Measure ment dBuV/m	Limit dBuV/m	Margin dB	Detector
1	178.8950	46.63	-15.73	30.90	43.50	-12.60	QP
2	215.7550	48.59	-16.65	31.94	43.50	-11.56	QP
3	455.8300	43.65	-9.03	34.62	46.00	-11.38	QP
4	503.8450	43.93	-8.44	35.49	46.00	-10.51	QP
5 *	600.3600	47.54	-6.32	41.22	46.00	-4.78	QP
6	983.9950	35.16	-0.56	34.60	54.00	-19.40	QP

Test Voltage	AC 120V/60Hz	Polarization	Horizontal
Test Mode	HDMI 1920*1080/75Hz 1.8m V		
Model	27P2U		

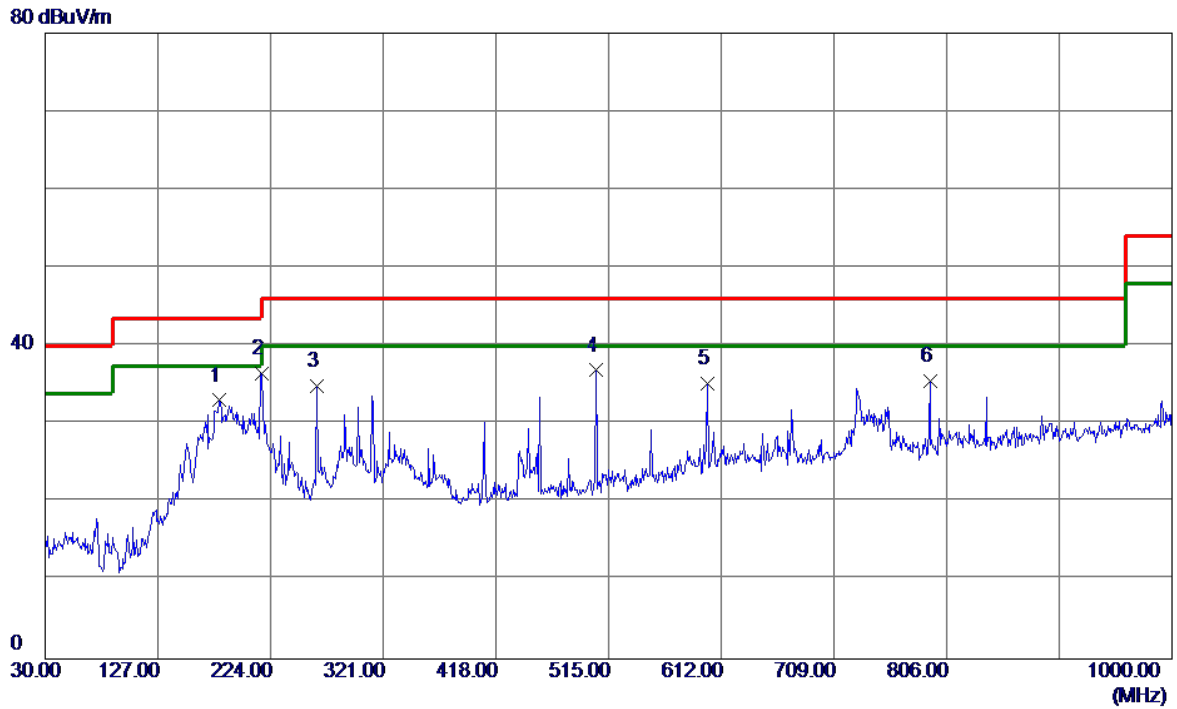

No.	Freq. MHz	Reading Level dBuV/m	Correct Factor dB	Measure ment dBuV/m	Limit dBuV/m	Margin dB	Detector
1	179.3800	48.81	-15.77	33.04	43.50	-10.46	QP
2	216.2400	53.16	-16.64	36.52	46.00	-9.48	QP
3	263.7700	49.41	-14.59	34.82	46.00	-11.18	QP
4 *	503.8450	45.32	-8.44	36.88	46.00	-9.12	QP
5	599.8750	41.49	-6.32	35.17	46.00	-10.83	QP
6	791.9350	38.93	-3.37	35.56	46.00	-10.44	QP

Test Voltage	AC 120V/60Hz	Polarization	Vertical
Test Mode	D-SUB 1920*1080/60Hz 1.8m V		
Model	27P2U		

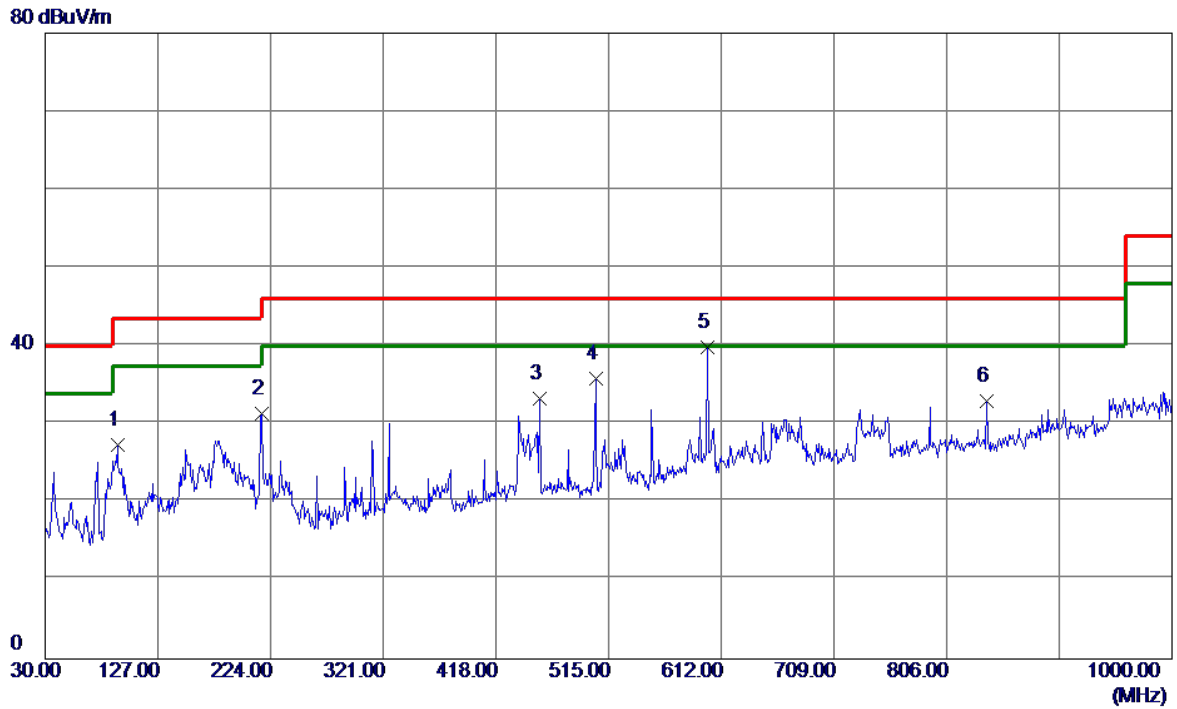

No.	Freq. MHz	Reading Level dBuV/m	Correct Factor dB	Measure ment dBuV/m	Limit dBuV/m	Margin dB	Detector
1	92.5650	48.37	-21.01	27.36	43.50	-16.14	QP
2	216.2400	48.03	-16.64	31.39	46.00	-14.61	QP
3	455.8300	42.24	-9.03	33.21	46.00	-12.79	QP
4	503.8450	44.23	-8.44	35.79	46.00	-10.21	QP
5 *	599.8750	46.10	-6.32	39.78	46.00	-6.22	QP
6	839.9500	35.89	-2.88	33.01	46.00	-12.99	QP

Test Voltage	AC 120V/60Hz	Polarization	Horizontal
Test Mode	D-SUB 1920*1080/60Hz 1.8m V		
Model	27P2U		

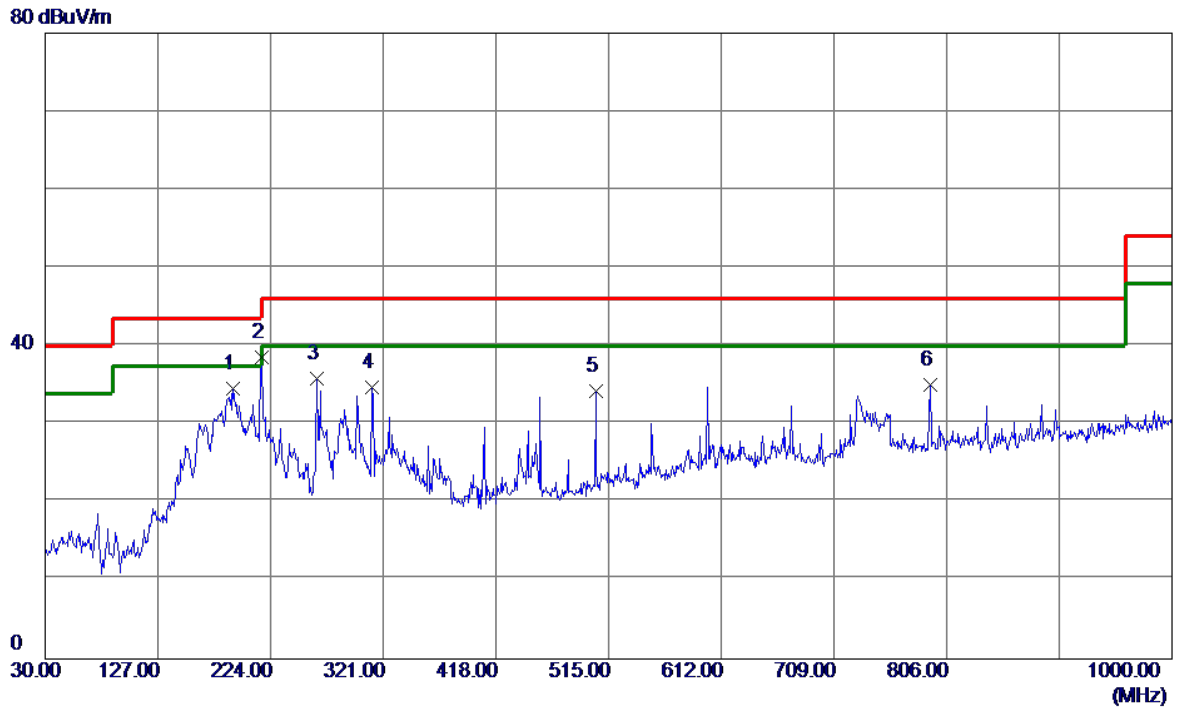

No.	Freq. MHz	Reading Level dBuV/m	Correct Factor dB	Measure ment dBuV/m	Limit dBuV/m	Margin dB	Detector
1	191.9900	51.29	-16.80	34.49	43.50	-9.01	QP
2 *	216.2400	55.15	-16.64	38.51	46.00	-7.49	QP
3	263.7700	50.36	-14.59	35.77	46.00	-10.23	QP
4	311.7850	47.38	-12.73	34.65	46.00	-11.35	QP
5	503.8450	42.65	-8.44	34.21	46.00	-11.79	QP
6	791.9350	38.46	-3.37	35.09	46.00	-10.91	QP

Test Voltage	AC 120V/60Hz	Polarization	Vertical
Test Mode	HDMI 1080P 1.8m V		
Model	27P2U		

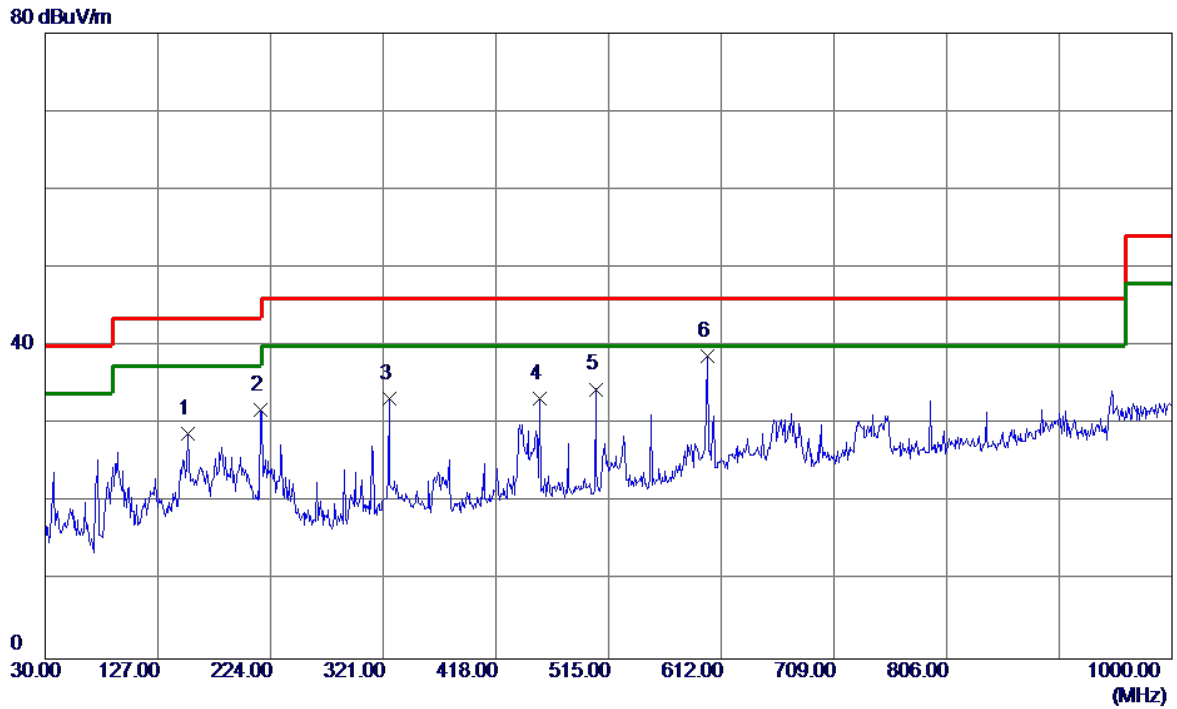

No.	Freq. MHz	Reading Level dBuV/m	Correct Factor dB	Measure ment dBuV/m	Limit dBuV/m	Margin dB	Detector
1	152.7050	43.29	-14.48	28.81	43.50	-14.69	QP
2	215.7550	48.42	-16.65	31.77	43.50	-11.73	QP
3	325.8500	45.51	-12.28	33.23	46.00	-12.77	QP
4	455.8300	42.25	-9.03	33.22	46.00	-12.78	QP
5	503.8450	42.92	-8.44	34.48	46.00	-11.52	QP
6 *	599.8750	45.10	-6.32	38.78	46.00	-7.22	QP

Test Voltage	AC 120V/60Hz	Polarization	Horizontal
Test Mode	HDMI 1080P 1.8m V		
Model	27P2U		

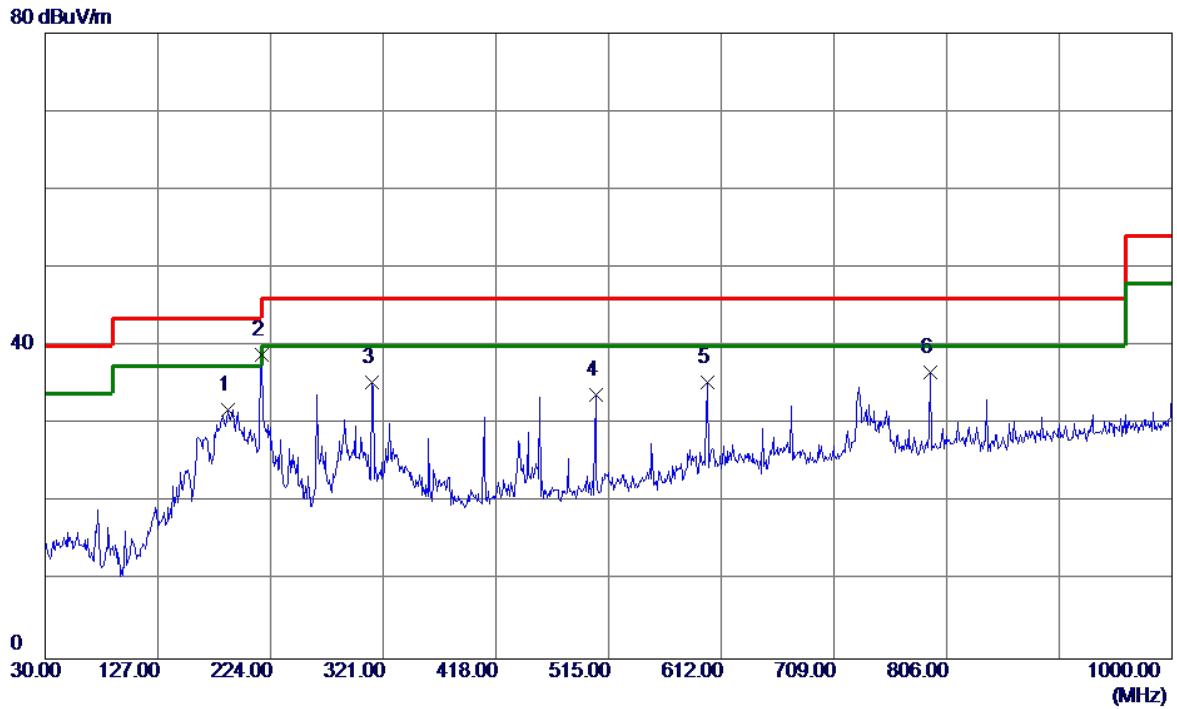

No.	Freq. MHz	Reading Level dBuV/m	Correct Factor dB	Measure ment dBuV/m	Limit dBuV/m	Margin dB	Detector
1	187.6250	48.40	-16.53	31.87	43.50	-11.63	QP
2 *	216.2400	55.55	-16.64	38.91	46.00	-7.09	QP
3	311.7850	48.14	-12.73	35.41	46.00	-10.59	QP
4	503.8450	42.21	-8.44	33.77	46.00	-12.23	QP
5	599.8750	41.64	-6.32	35.32	46.00	-10.68	QP
6	791.9350	40.06	-3.37	36.69	46.00	-9.31	QP

3.3 RADIATED EMISSIONS ABOVE 1 GHZ

3.3.1 LIMIT

Frequency (MHz)	Class B	
	(dBuV/m) (at 3m)	
	Peak	Average
Above 1000	74	54

FREQUENCY RANGE OF RADIATED MEASUREMENT (FOR UNINTENTIONAL RADIATORS)

Highest frequency generated or Upper frequency of measurement used in the device or on which the device operates or tunes (MHz)	Range (MHz)
Below 1.705	30
1.705 - 108	1000
108 - 500	2000
500 - 1000	5000
Above 1000	5 th harmonic of the highest frequency or 40 GHz, whichever is lower

NOTE:

- (1) The tighter limit applies at the band edges.
- (2) Emission level (dBuV/m) = 20log Emission level (uV/m).
3m Emission level = 10m Emission level + 20log(10m/3m).
- (3) The test result calculated as following:
Measurement Value = Reading Level + Correct Factor
Correct Factor = Antenna Factor + Cable Loss - Amplifier Gain(if use)
Margin Level = Measurement Value - Limit Value

3.3.2 MEASUREMENT INSTRUMENTS LIST

Item	Kind of Equipment	Manufacturer	Type No.	Serial No.	Calibrated until
1	Double Ridged Guide Antenna	ETS	3115	75846	Mar. 19, 2021
2	Amplifier	Agilent	8449B	3008A02333	Mar. 01, 2021
3	MXE EMI Receiver	Agilent	N9038A	MY53220133	Feb. 28, 2021
4	Measurement Software	Farad	EZ-EMC Ver.BTL-2ANT-1	N/A	N/A
5	Multi-Device Controller	ETS-Lindgren	2090	N/A	N/A
6	Controller	MF	MF-7802	MF780208159	N/A
7	Cable	Mlcable Inc.	B10-01-01-5M	18047123	Feb. 28, 2021
8	Cable	Mlcable Inc.	B10-01-01-12M	18072743	Feb. 28, 2021
9	Cable	RegalWay	RWLPS50-7.9A-SMSM-1 M	20200102 001	Feb. 28, 2021

Remark: "N/A" denotes no model name, no serial no. or no calibration specified.

All calibration period of equipment list is one year.

3.3.3 TEST PROCEDURE

- a. The measuring distance of 3 m shall be used for measurements. The EUT was placed on the top of a rotating table 0.8 meter above the ground at a 10 meter semi-anechoic chamber. The table was rotated 360 degrees to determine the position of the highest radiation.
- b. The height of the equipment or of the substitution antenna shall be 0.8 m, the height of the test antenna shall vary between 1 m to 4 m. Both horizontal and vertical polarizations of the antenna are set to make the measurement.
- c. For each suspected emission, the EUT was arranged to its worst case and then the antenna was tuned to heights find the maximum reading (used Bore sight function).
- d. The initial step in collecting radiated emission data is a receiver peak detector mode pre-scanning the measurement frequency range. Significant peaks are then marked and then Quasi Peak detector mode re-measured.
- e. The receiver system was set to peak and average detect function and specified bandwidth with maximum hold mode when the test frequency is above 1 GHz.
- f. All readings are Peak Mode value unless otherwise stated AVG in column of Note. If the Peak Mode Measured value compliance with the Peak Limits and lower than AVG Limits, the EUT shall be deemed to meet both Peak & AVG Limits and then only Peak Mode was measured, but AVG Mode didn't perform.
- g. For the actual test configuration, please refer to the related Item - Block Diagram of system tested.

3.3.4 DEVIATION FROM TEST STANDARD

No deviation

3.3.5 TEST SETUP

Above 1GHz

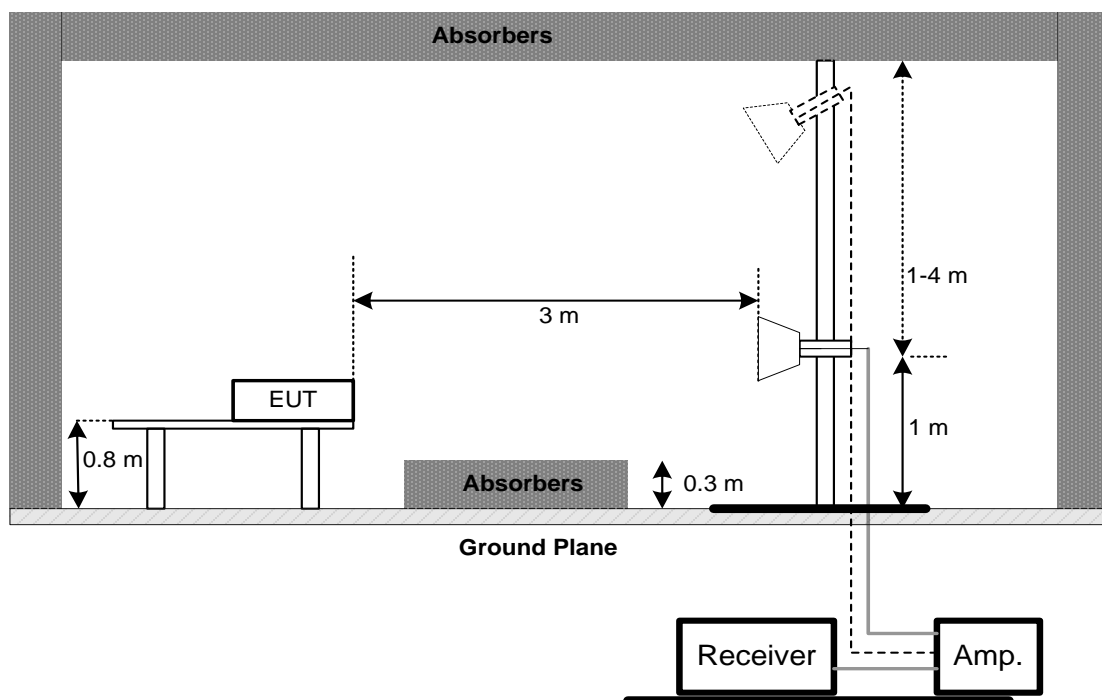

3.3.6 TEST RESULTS-ABOVE 1 GHZ

Remark :

- (1) Radiated emissions measured in frequency range above 1000 MHz were made with an instrument using Peak detector mode and AV detector mode of the emission.
- (2) Data of measurement within this frequency range shown “ * ” in the table above means the reading of emissions are attenuated more than 20 dB below the permissible limits or the field strength is too small to be measured.
- (3) A preamp and high pass filter were used for this test in order to provide sufficient measurement sensitivity.

Test Voltage	AC 120V/60Hz	Polarization	Vertical
Test Mode	HDMI 1920*1080/75Hz 1.8m H		
Model	27P2Q		

86.9 dBuV/m

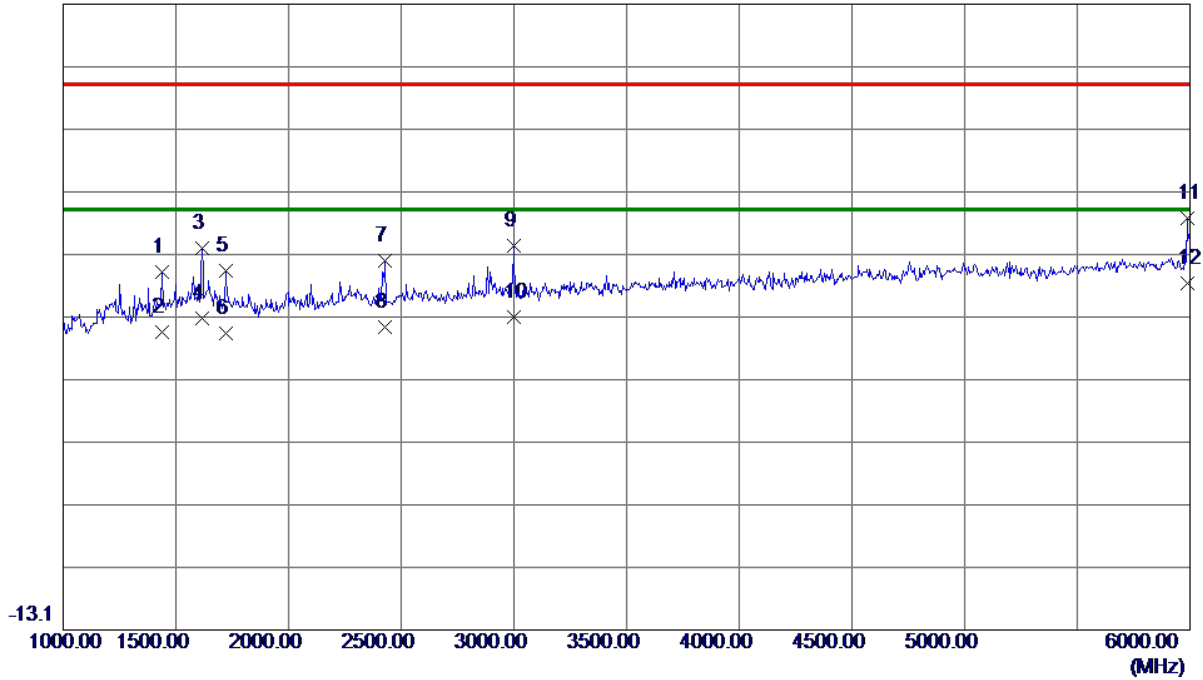

No.	Freq. MHz	Reading Level dBuV/m	Correct Factor dB	Measure ment dBuV/m	Limit dBuV/m	Margin dB	Detector
1	1440.0000	46.62	-2.53	44.09	74.00	-29.91	Peak
2	1440.0000	36.95	-2.53	34.42	54.00	-19.58	AVG
3	1615.0000	49.53	-1.59	47.94	74.00	-26.06	Peak
4	1615.0000	38.38	-1.59	36.79	54.00	-17.21	AVG
5	1722.5000	45.38	-1.16	44.22	74.00	-29.78	Peak
6	1722.5000	35.50	-1.16	34.34	54.00	-19.66	AVG
7	2430.0000	44.21	1.77	45.98	74.00	-28.02	Peak
8	2430.0000	33.46	1.77	35.23	54.00	-18.77	AVG
9	2997.5000	44.59	3.76	48.35	74.00	-25.65	Peak
10	2997.5000	33.19	3.76	36.95	54.00	-17.05	AVG
11	5987.5000	39.76	12.91	52.67	74.00	-21.33	Peak
12 *	5987.5000	29.41	12.91	42.32	54.00	-11.68	AVG

Test Voltage	AC 120V/60Hz	Polarization	Horizontal
Test Mode	HDMI 1920*1080/75Hz 1.8m H		
Model	27P2Q		

86.9 dBuV/m

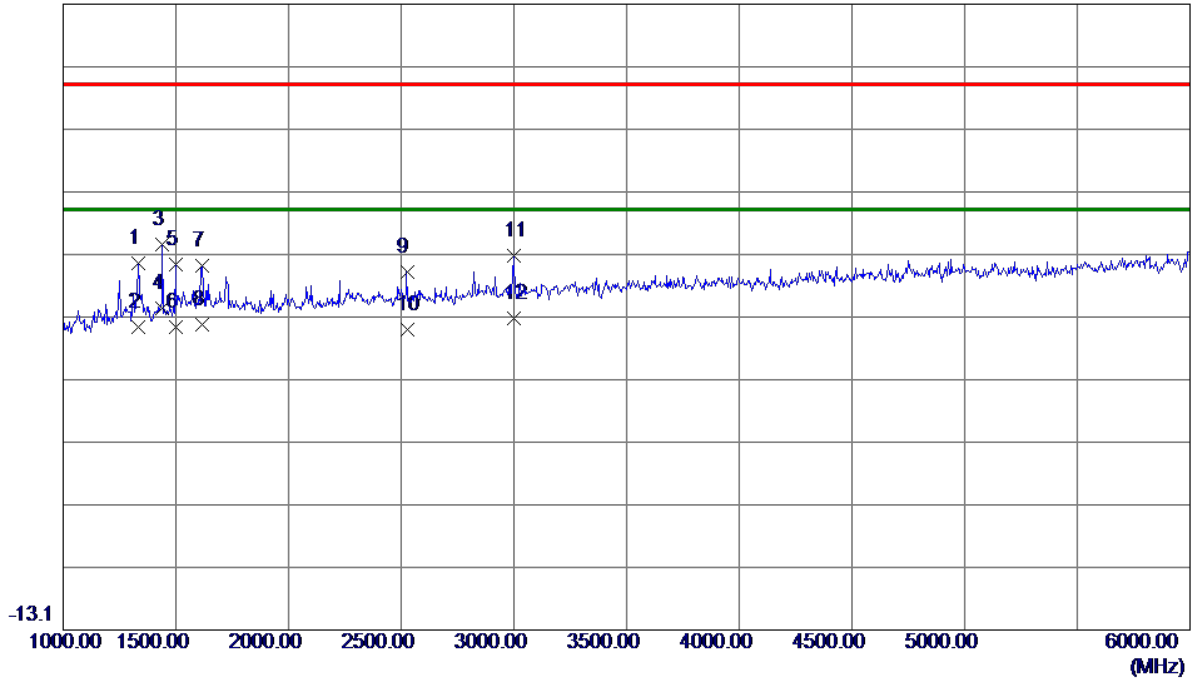

No.	Freq. MHz	Reading Level dBuV/m	Correct Factor dB	Measure ment dBuV/m	Limit dBuV/m	Margin dB	Detector
1	1332.5000	48.89	-3.41	45.48	74.00	-28.52	Peak
2	1332.5000	38.70	-3.41	35.29	54.00	-18.71	AVG
3	1440.0000	51.03	-2.53	48.50	74.00	-25.50	Peak
4 *	1440.0000	40.88	-2.53	38.35	54.00	-15.65	AVG
5	1497.5000	47.38	-2.06	45.32	74.00	-28.68	Peak
6	1497.5000	37.43	-2.06	35.37	54.00	-18.63	AVG
7	1615.0000	46.73	-1.59	45.14	74.00	-28.86	Peak
8	1615.0000	37.23	-1.59	35.64	54.00	-18.36	AVG
9	2525.0000	41.98	2.15	44.13	74.00	-29.87	Peak
10	2525.0000	32.68	2.15	34.83	54.00	-19.17	AVG
11	2997.5000	42.87	3.76	46.63	74.00	-27.37	Peak
12	2997.5000	32.96	3.76	36.72	54.00	-17.28	AVG

Test Voltage	AC 120V/60Hz	Polarization	Vertical
Test Mode	D-SUB 1920*1080/60Hz 1.8m H		
Model	27P2Q		

86.9 dBuV/m

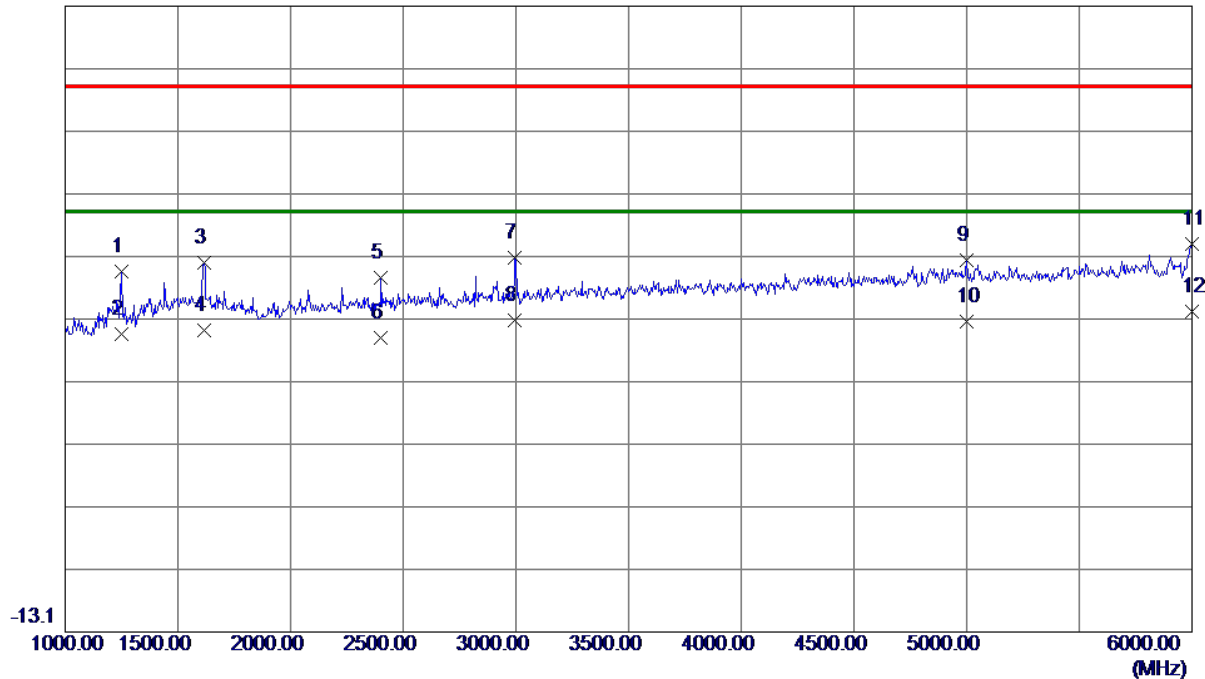

No.	Freq. MHz	Reading Level dBuV/m	Correct Factor dB	Measure ment dBuV/m	Limit dBuV/m	Margin dB	Detector
1	1247.5000	48.58	-4.11	44.47	74.00	-29.53	Peak
2	1247.5000	38.60	-4.11	34.49	54.00	-19.51	AVG
3	1617.5000	47.41	-1.58	45.83	74.00	-28.17	Peak
4	1617.5000	36.76	-1.58	35.18	54.00	-18.82	AVG
5	2400.0000	41.78	1.64	43.42	74.00	-30.58	Peak
6	2400.0000	32.28	1.64	33.92	54.00	-20.08	AVG
7	2995.0000	43.03	3.75	46.78	74.00	-27.22	Peak
8	2995.0000	33.03	3.75	36.78	54.00	-17.22	AVG
9	5002.5000	36.06	10.17	46.23	74.00	-27.77	Peak
10	5002.5000	26.36	10.17	36.53	54.00	-17.47	AVG
11	5997.5000	35.93	12.95	48.88	74.00	-25.12	Peak
12 *	5997.5000	25.18	12.95	38.13	54.00	-15.87	AVG

Test Voltage	AC 120V/60Hz	Polarization	Horizontal
Test Mode	D-SUB 1920*1080/60Hz 1.8m H		
Model	27P2Q		

86.9 dBuV/m

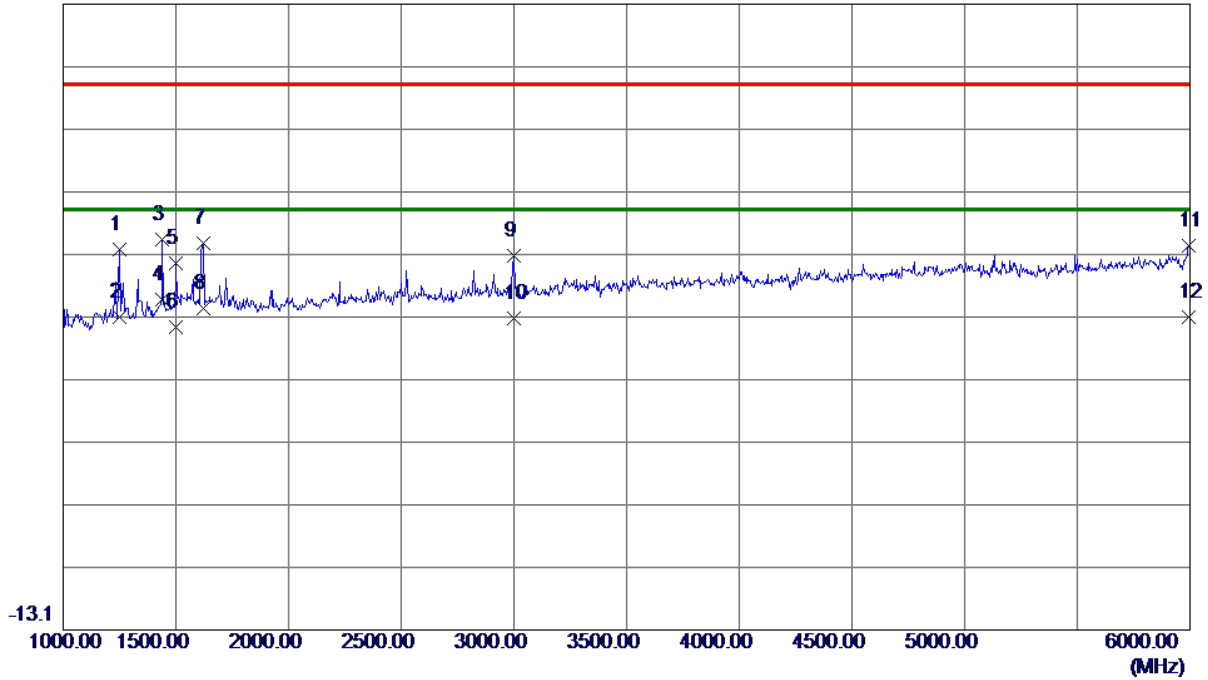

No.	Freq. MHz	Reading Level dBuV/m	Correct Factor dB	Measure ment dBuV/m	Limit dBuV/m	Margin dB	Detector
1	1247.5000	51.87	-4.11	47.76	74.00	-26.24	Peak
2	1247.5000	41.00	-4.11	36.89	54.00	-17.11	AVG
3	1440.0000	51.76	-2.53	49.23	74.00	-24.77	Peak
4 *	1440.0000	42.22	-2.53	39.69	54.00	-14.31	AVG
5	1500.0000	47.62	-2.04	45.58	74.00	-28.42	Peak
6	1500.0000	37.43	-2.04	35.39	54.00	-18.61	AVG
7	1620.0000	50.33	-1.57	48.76	74.00	-25.24	Peak
8	1620.0000	39.84	-1.57	38.27	54.00	-15.73	AVG
9	2997.5000	43.03	3.76	46.79	74.00	-27.21	Peak
10	2997.5000	32.99	3.76	36.75	54.00	-17.25	AVG
11	5995.0000	35.37	12.94	48.31	74.00	-25.69	Peak
12	5995.0000	24.04	12.94	36.98	54.00	-17.02	AVG

Test Voltage	AC 120V/60Hz	Polarization	Vertical
Test Mode	HDMI 1080P 1.8m H		
Model	27P2Q		

86.9 dBuV/m

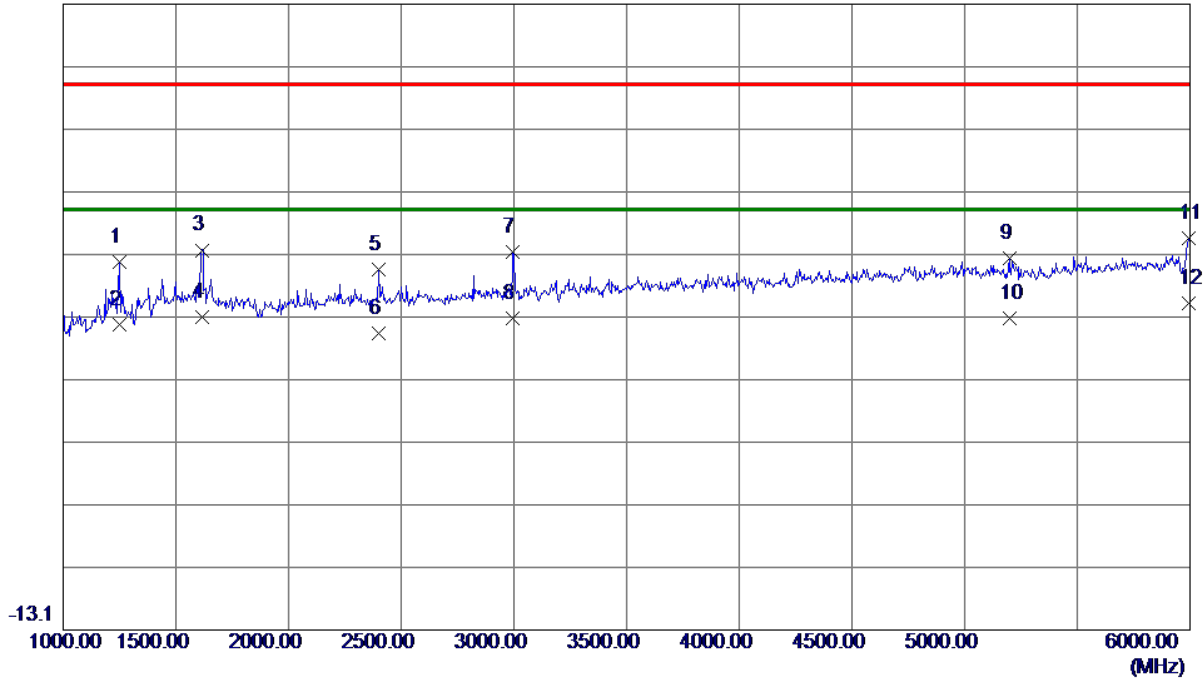

No.	Freq. MHz	Reading Level dBuV/m	Correct Factor dB	Measure ment dBuV/m	Limit dBuV/m	Margin dB	Detector
1	1247.5000	49.89	-4.11	45.78	74.00	-28.22	Peak
2	1247.5000	39.72	-4.11	35.61	54.00	-18.39	AVG
3	1617.5000	49.18	-1.58	47.60	74.00	-26.40	Peak
4	1617.5000	38.51	-1.58	36.93	54.00	-17.07	AVG
5	2400.0000	42.89	1.64	44.53	74.00	-29.47	Peak
6	2400.0000	32.64	1.64	34.28	54.00	-19.72	AVG
7	2995.0000	43.55	3.75	47.30	74.00	-26.70	Peak
8	2995.0000	33.03	3.75	36.78	54.00	-17.22	AVG
9	5197.5000	35.76	10.55	46.31	74.00	-27.69	Peak
10	5197.5000	26.17	10.55	36.72	54.00	-17.28	AVG
11	5995.0000	36.63	12.94	49.57	74.00	-24.43	Peak
12 *	5995.0000	26.20	12.94	39.14	54.00	-14.86	AVG

Test Voltage	AC 120V/60Hz	Polarization	Horizontal
Test Mode	HDMI 1080P 1.8m H		
Model	27P2Q		

86.9 dBuV/m

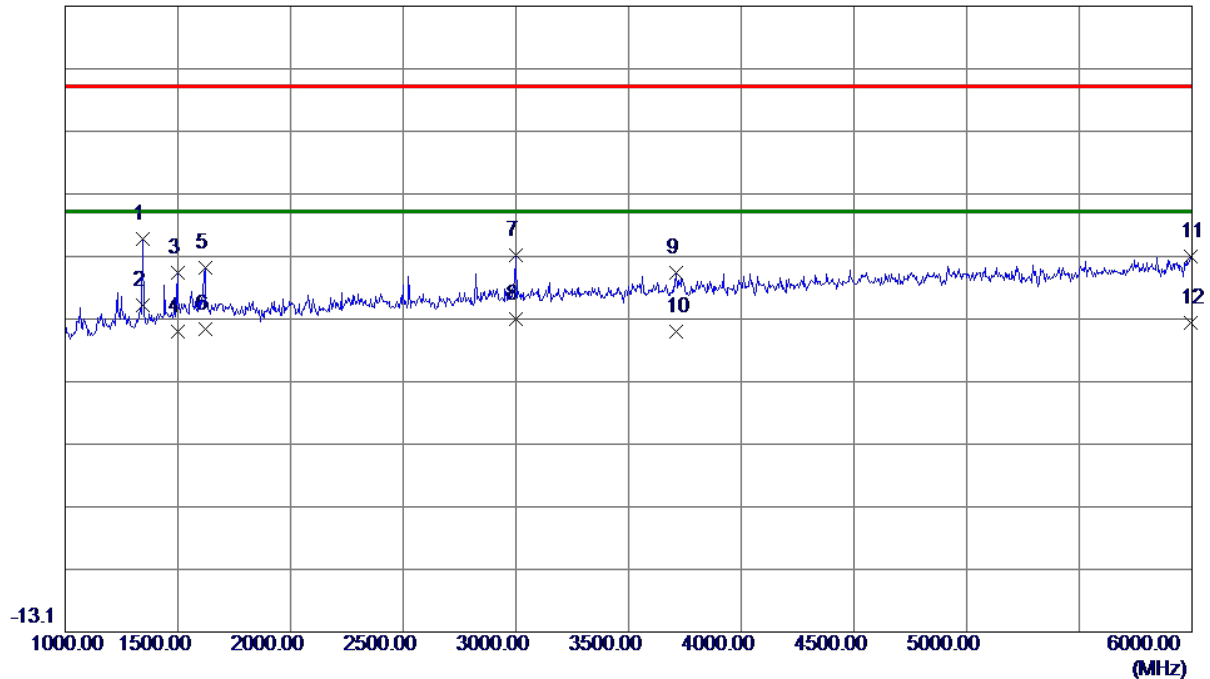

No.	Freq. MHz	Reading Level dBuV/m	Correct Factor dB	Measure ment dBuV/m	Limit dBuV/m	Margin dB	Detector
1	1342.5000	53.02	-3.33	49.69	74.00	-24.31	Peak
2 *	1342.5000	42.51	-3.33	39.18	54.00	-14.82	AVG
3	1497.5000	46.44	-2.06	44.38	74.00	-29.62	Peak
4	1497.5000	36.89	-2.06	34.83	54.00	-19.17	AVG
5	1620.0000	46.62	-1.57	45.05	74.00	-28.95	Peak
6	1620.0000	36.78	-1.57	35.21	54.00	-18.79	AVG
7	2997.5000	43.35	3.76	47.11	74.00	-26.89	Peak
8	2997.5000	33.21	3.76	36.97	54.00	-17.03	AVG
9	3712.5000	38.08	6.26	44.34	74.00	-29.66	Peak
10	3712.5000	28.60	6.26	34.86	54.00	-19.14	AVG
11	5995.0000	33.98	12.94	46.92	74.00	-27.08	Peak
12	5995.0000	23.43	12.94	36.37	54.00	-17.63	AVG

Test Voltage	AC 120V/60Hz	Polarization	Vertical
Test Mode	HDMI 1920*1080/75Hz 1.8m V		
Model	27P2U		

86.9 dBuV/m

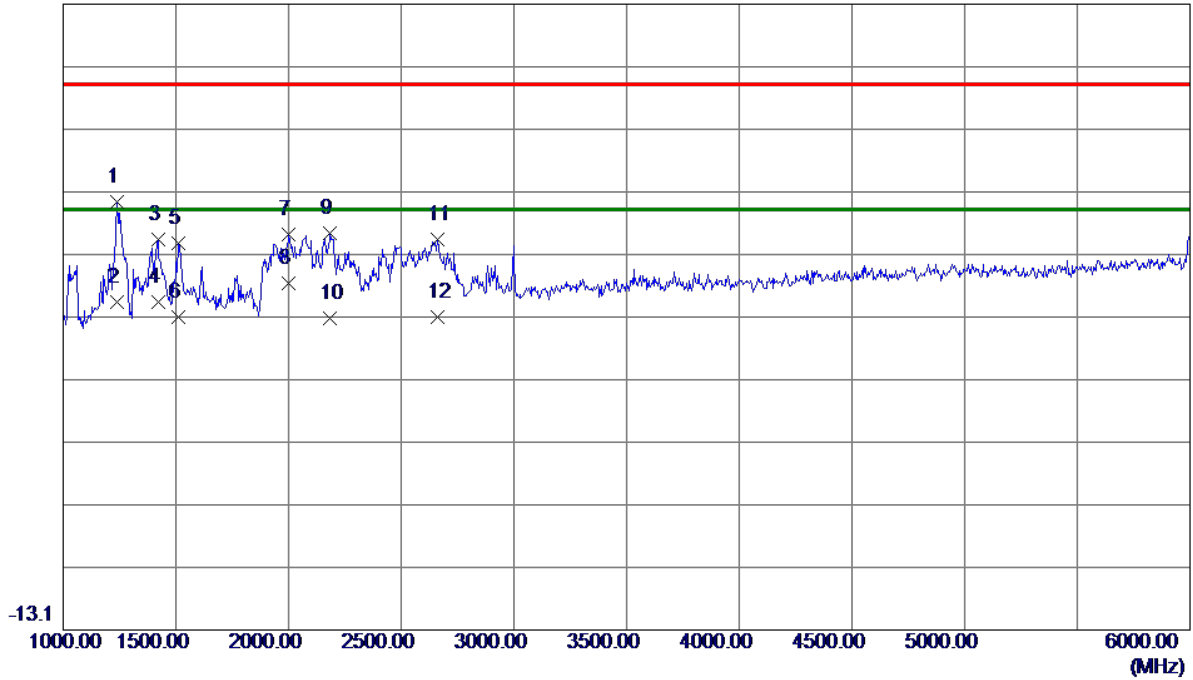

No.	Freq. MHz	Reading Level dBuV/m	Correct Factor dB	Measure ment dBuV/m	Limit dBuV/m	Margin dB	Detector
1	1237.5000	59.45	-4.19	55.26	74.00	-18.74	Peak
2	1237.5000	43.55	-4.19	39.36	54.00	-14.64	AVG
3	1420.0000	51.97	-2.70	49.27	74.00	-24.73	Peak
4	1420.0000	41.98	-2.70	39.28	54.00	-14.72	AVG
5	1512.5000	50.63	-1.99	48.64	74.00	-25.36	Peak
6	1512.5000	38.83	-1.99	36.84	54.00	-17.16	AVG
7	2002.5000	50.10	-0.06	50.04	74.00	-23.96	Peak
8 *	2002.5000	42.41	-0.06	42.35	54.00	-11.65	AVG
9	2185.0000	49.50	0.72	50.22	74.00	-23.78	Peak
10	2185.0000	36.07	0.72	36.79	54.00	-17.21	AVG
11	2660.0000	46.70	2.61	49.31	74.00	-24.69	Peak
12	2660.0000	34.30	2.61	36.91	54.00	-17.09	AVG

Test Voltage	AC 120V/60Hz	Polarization	Horizontal
Test Mode	HDMI 1920*1080/75Hz 1.8m V		
Model	27P2U		

86.9 dBuV/m

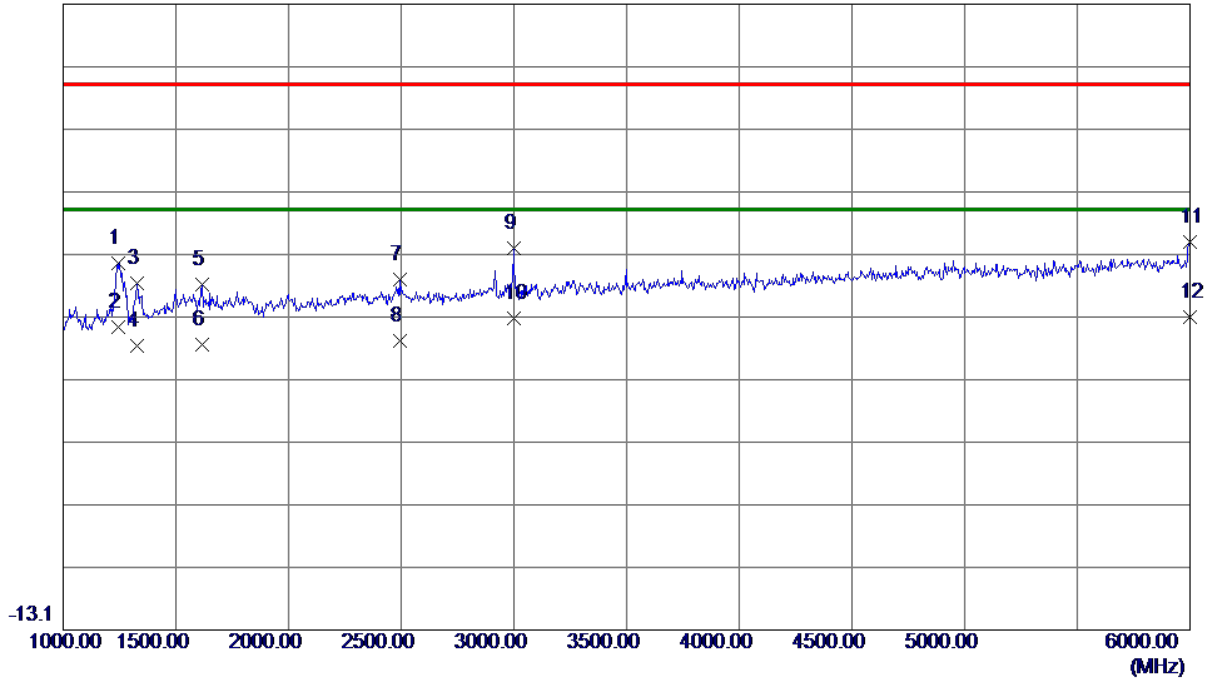

No.	Freq. MHz	Reading Level dBuV/m	Correct Factor dB	Measure ment dBuV/m	Limit dBuV/m	Margin dB	Detector
1	1245.0000	49.55	-4.13	45.42	74.00	-28.58	Peak
2	1245.0000	39.40	-4.13	35.27	54.00	-18.73	AVG
3	1330.0000	45.72	-3.43	42.29	74.00	-31.71	Peak
4	1330.0000	35.71	-3.43	32.28	54.00	-21.72	AVG
5	1615.0000	43.67	-1.59	42.08	74.00	-31.92	Peak
6	1615.0000	34.18	-1.59	32.59	54.00	-21.41	AVG
7	2492.5000	40.77	2.04	42.81	74.00	-31.19	Peak
8	2492.5000	31.10	2.04	33.14	54.00	-20.86	AVG
9	2997.5000	44.17	3.76	47.93	74.00	-26.07	Peak
10	2997.5000	32.92	3.76	36.68	54.00	-17.32	AVG
11	5997.5000	35.99	12.95	48.94	74.00	-25.06	Peak
12 *	5997.5000	24.00	12.95	36.95	54.00	-17.05	AVG

Test Voltage	AC 120V/60Hz	Polarization	Vertical
Test Mode	D-SUB 1920*1080/60Hz 1.8m V		
Model	27P2U		

86.9 dBuV/m

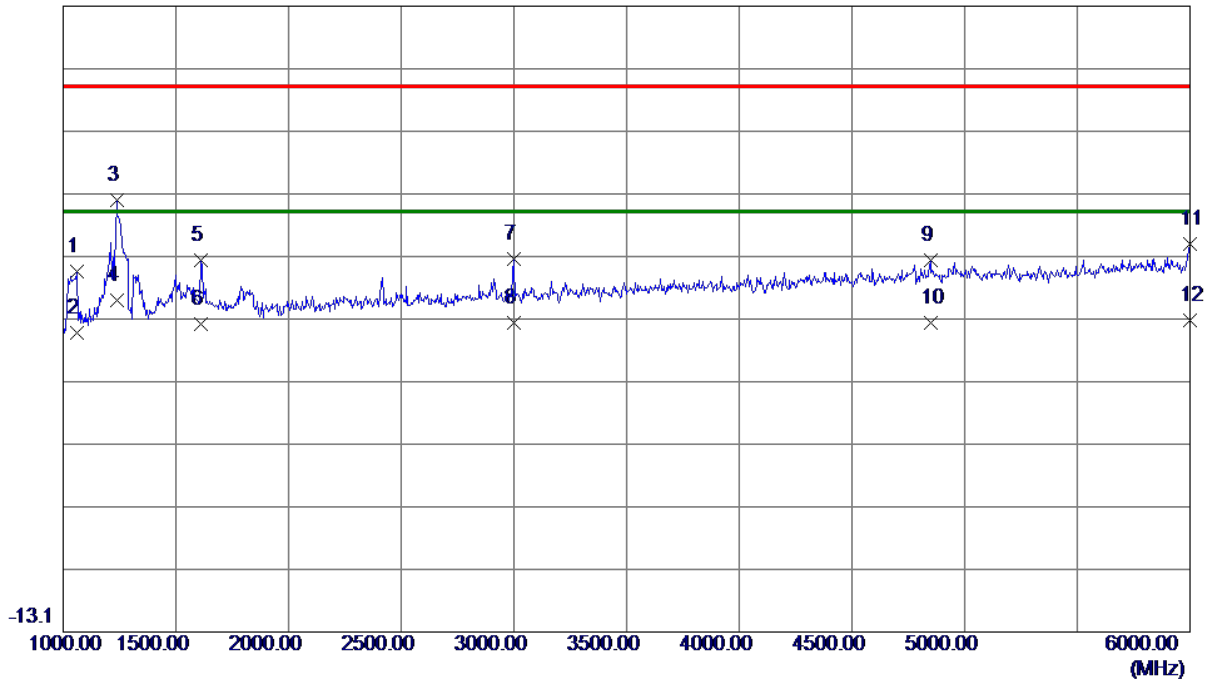

No.	Freq. MHz	Reading Level dBuV/m	Correct Factor dB	Measure ment dBuV/m	Limit dBuV/m	Margin dB	Detector
1	1060.0000	50.18	-5.65	44.53	74.00	-29.47	Peak
2	1060.0000	40.40	-5.65	34.75	54.00	-19.25	AVG
3	1237.5000	60.09	-4.19	55.90	74.00	-18.10	Peak
4 *	1237.5000	44.07	-4.19	39.88	54.00	-14.12	AVG
5	1612.5000	47.98	-1.60	46.38	74.00	-27.62	Peak
6	1612.5000	37.75	-1.60	36.15	54.00	-17.85	AVG
7	2997.5000	42.82	3.76	46.58	74.00	-27.42	Peak
8	2997.5000	32.47	3.76	36.23	54.00	-17.77	AVG
9	4847.5000	36.63	9.75	46.38	74.00	-27.62	Peak
10	4847.5000	26.59	9.75	36.34	54.00	-17.66	AVG
11	6000.0000	36.01	12.96	48.97	74.00	-25.03	Peak
12	6000.0000	23.73	12.96	36.69	54.00	-17.31	AVG

Test Voltage	AC 120V/60Hz	Polarization	Horizontal
Test Mode	D-SUB 1920*1080/60Hz 1.8m V		
Model	27P2U		

86.9 dBuV/m

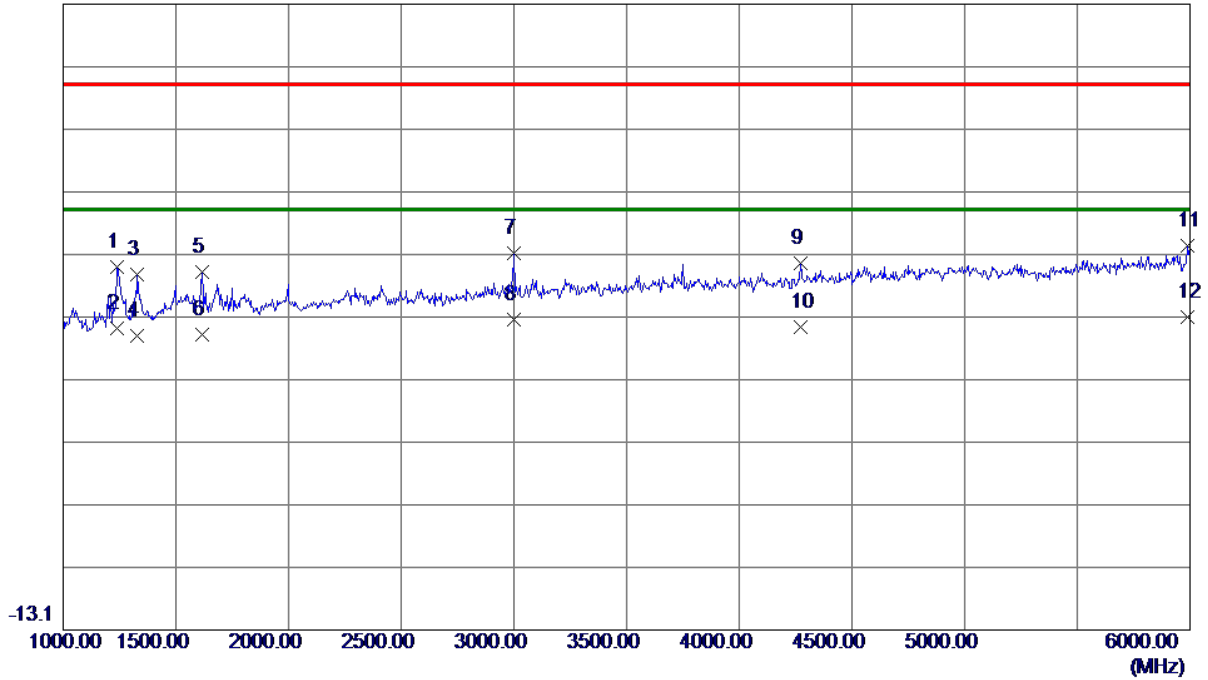

No.	Freq. MHz	Reading Level dBuV/m	Correct Factor dB	Measure ment dBuV/m	Limit dBuV/m	Margin dB	Detector
1	1237.5000	49.04	-4.19	44.85	74.00	-29.15	Peak
2	1237.5000	39.26	-4.19	35.07	54.00	-18.93	AVG
3	1330.0000	47.15	-3.43	43.72	74.00	-30.28	Peak
4	1330.0000	37.27	-3.43	33.84	54.00	-20.16	AVG
5	1615.0000	45.60	-1.59	44.01	74.00	-29.99	Peak
6	1615.0000	35.73	-1.59	34.14	54.00	-19.86	AVG
7	3000.0000	43.38	3.77	47.15	74.00	-26.85	Peak
8	3000.0000	32.79	3.77	36.56	54.00	-17.44	AVG
9	4272.5000	37.36	8.14	45.50	74.00	-28.50	Peak
10	4272.5000	27.13	8.14	35.27	54.00	-18.73	AVG
11	5987.5000	35.33	12.91	48.24	74.00	-25.76	Peak
12 *	5987.5000	24.02	12.91	36.93	54.00	-17.07	AVG

Test Voltage	AC 120V/60Hz	Polarization	Vertical
Test Mode	HDMI 1080P 1.8m V		
Model	27P2U		

86.9 dBuV/m

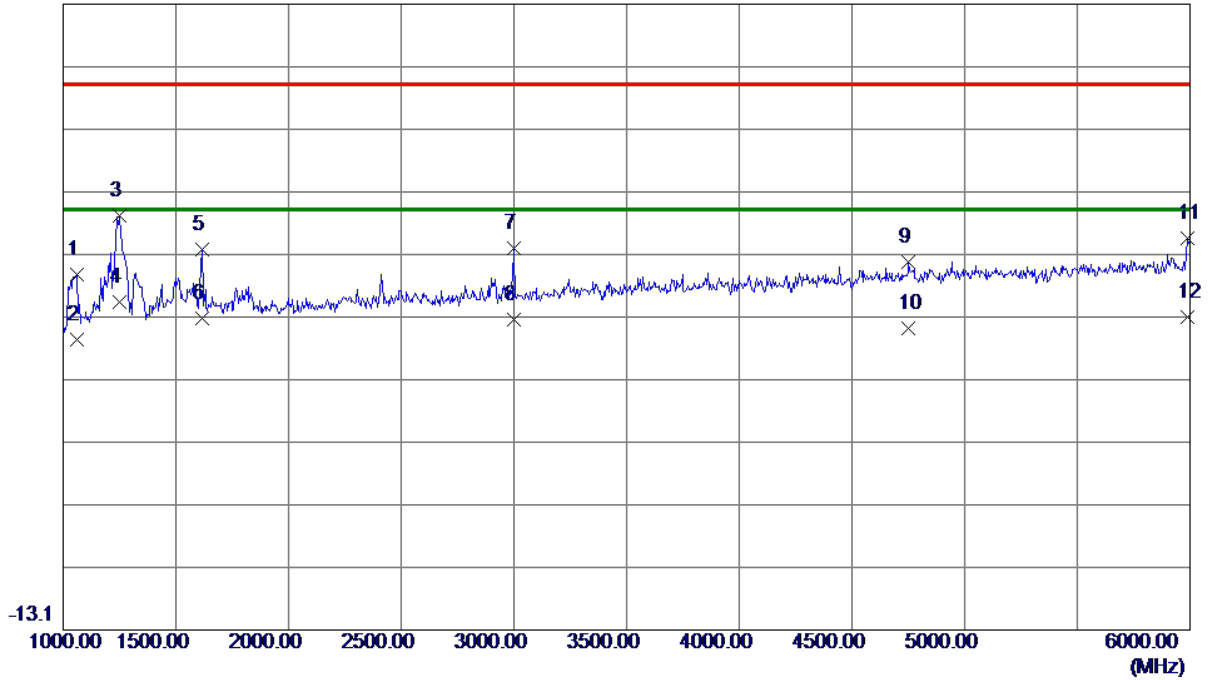

No.	Freq. MHz	Reading Level dBuV/m	Correct Factor dB	Measure ment dBuV/m	Limit dBuV/m	Margin dB	Detector
1	1060.0000	49.27	-5.65	43.62	74.00	-30.38	Peak
2	1060.0000	39.03	-5.65	33.38	54.00	-20.62	AVG
3	1247.5000	57.13	-4.11	53.02	74.00	-20.98	Peak
4 *	1247.5000	43.42	-4.11	39.31	54.00	-14.69	AVG
5	1615.0000	49.37	-1.59	47.78	74.00	-26.22	Peak
6	1615.0000	38.21	-1.59	36.62	54.00	-17.38	AVG
7	2997.5000	44.11	3.76	47.87	74.00	-26.13	Peak
8	2997.5000	32.69	3.76	36.45	54.00	-17.55	AVG
9	4752.5000	36.29	9.49	45.78	74.00	-28.22	Peak
10	4752.5000	25.66	9.49	35.15	54.00	-18.85	AVG
11	5987.5000	36.63	12.91	49.54	74.00	-24.46	Peak
12	5987.5000	24.06	12.91	36.97	54.00	-17.03	AVG

Test Voltage	AC 120V/60Hz	Polarization	Horizontal
Test Mode	HDMI 1080P 1.8m V		
Model	27P2U		

86.9 dBuV/m

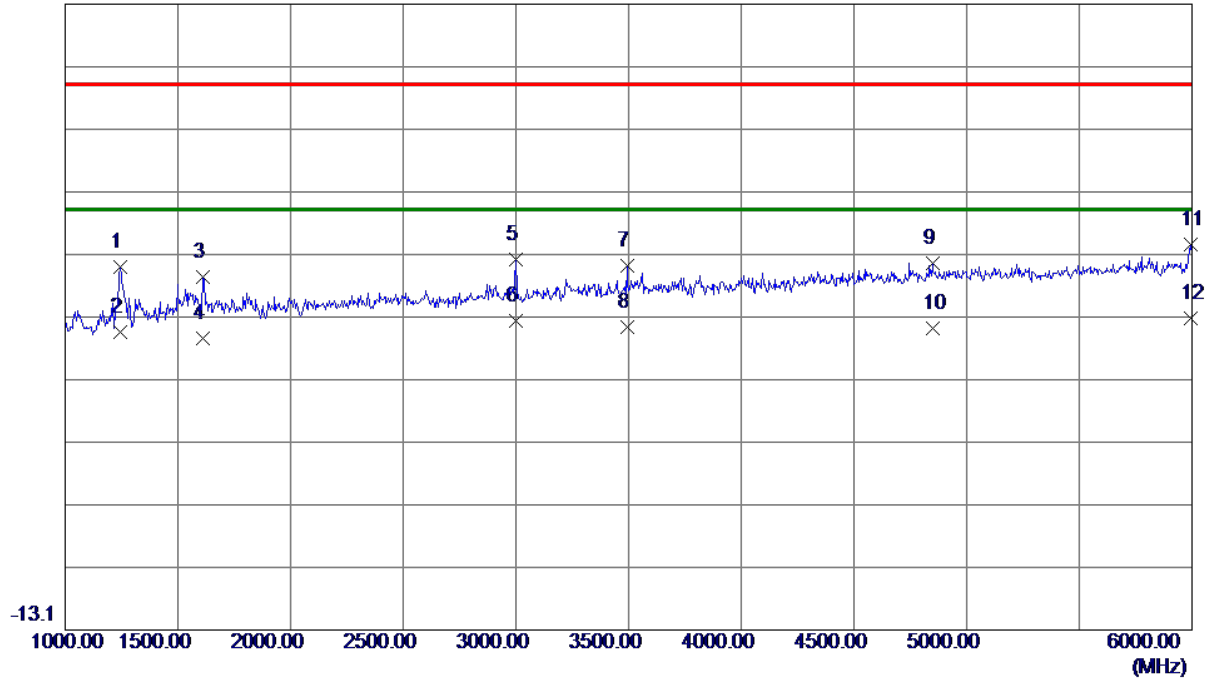

No.	Freq. MHz	Reading Level dBuV/m	Correct Factor dB	Measure ment dBuV/m	Limit dBuV/m	Margin dB	Detector
1	1242.5000	49.11	-4.15	44.96	74.00	-29.04	Peak
2	1242.5000	38.56	-4.15	34.41	54.00	-19.59	AVG
3	1612.5000	44.82	-1.60	43.22	74.00	-30.78	Peak
4	1612.5000	35.19	-1.60	33.59	54.00	-20.41	AVG
5	3000.0000	42.38	3.77	46.15	74.00	-27.85	Peak
6	3000.0000	32.61	3.77	36.38	54.00	-17.62	AVG
7	3492.5000	39.65	5.42	45.07	74.00	-28.93	Peak
8	3492.5000	29.83	5.42	35.25	54.00	-18.75	AVG
9	4847.5000	35.72	9.75	45.47	74.00	-28.53	Peak
10	4847.5000	25.41	9.75	35.16	54.00	-18.84	AVG
11	5992.5000	35.48	12.93	48.41	74.00	-25.59	Peak
12 *	5992.5000	23.83	12.93	36.76	54.00	-17.24	AVG

4. EUT TEST PHOTO

27P2Q

AC Power Line Conducted Emissions



Radiated Emissions 30 MHz to 1 GHz

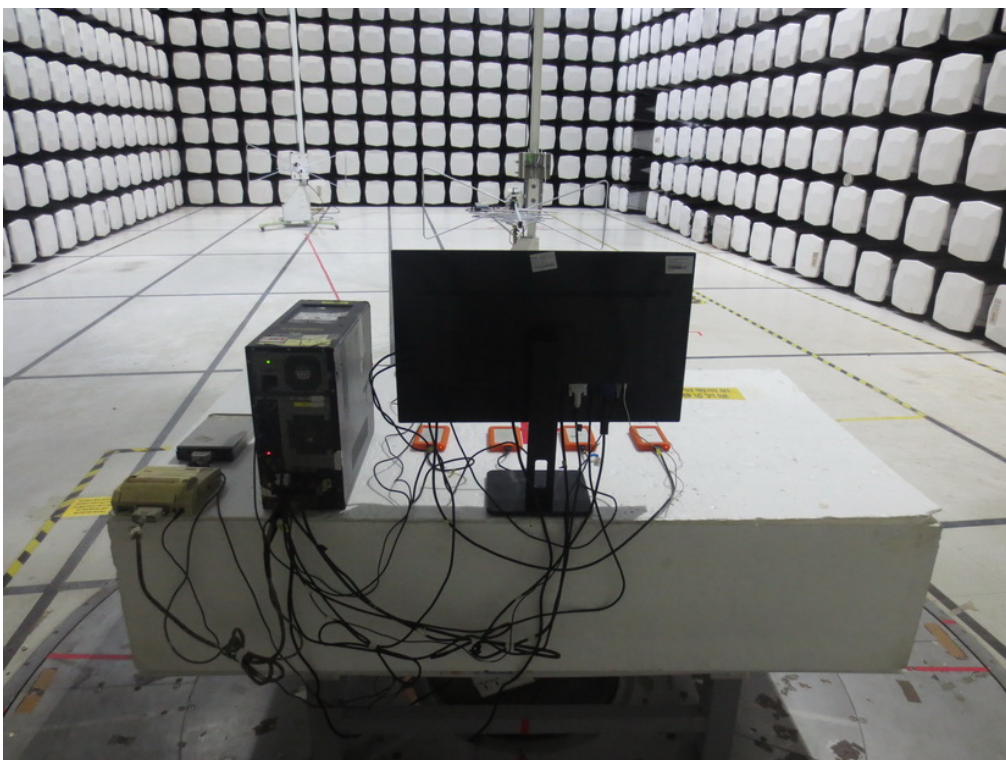
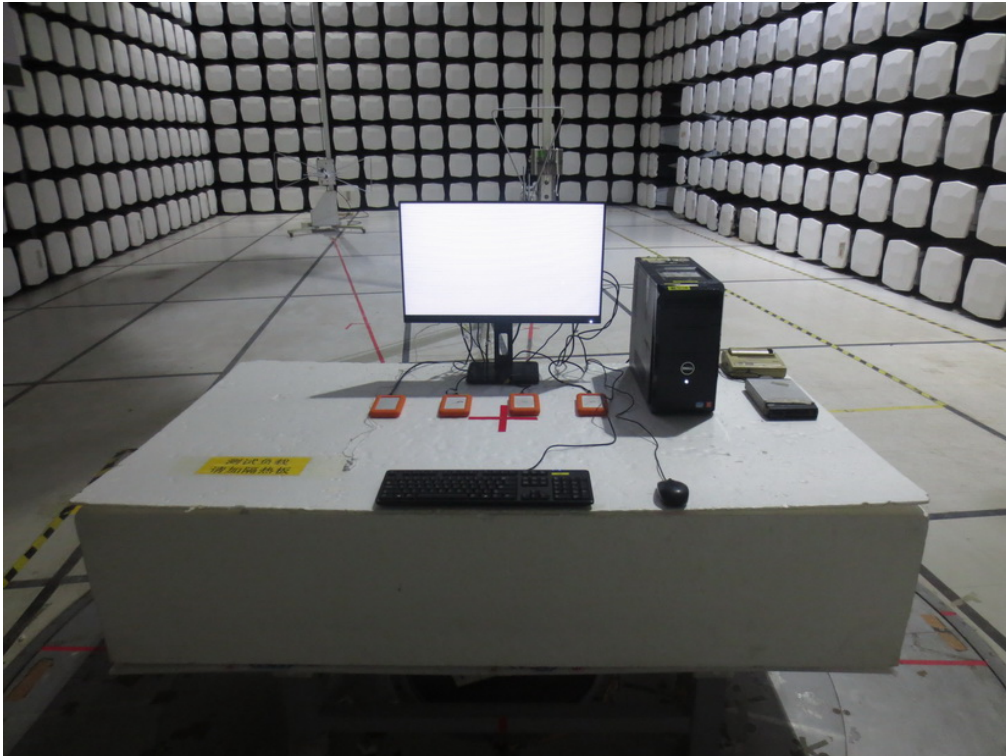

Radiated Emissions Above 1 GHz

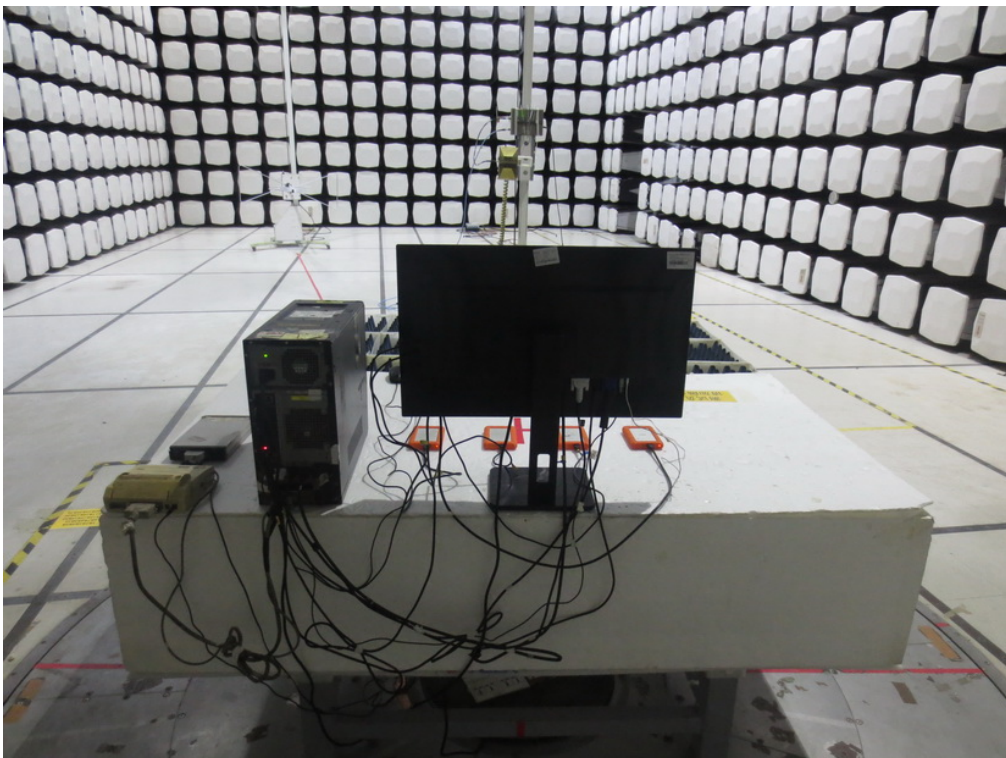

27P2U

AC Power Line Conducted Emissions



Radiated Emissions 30 MHz to 1 GHz

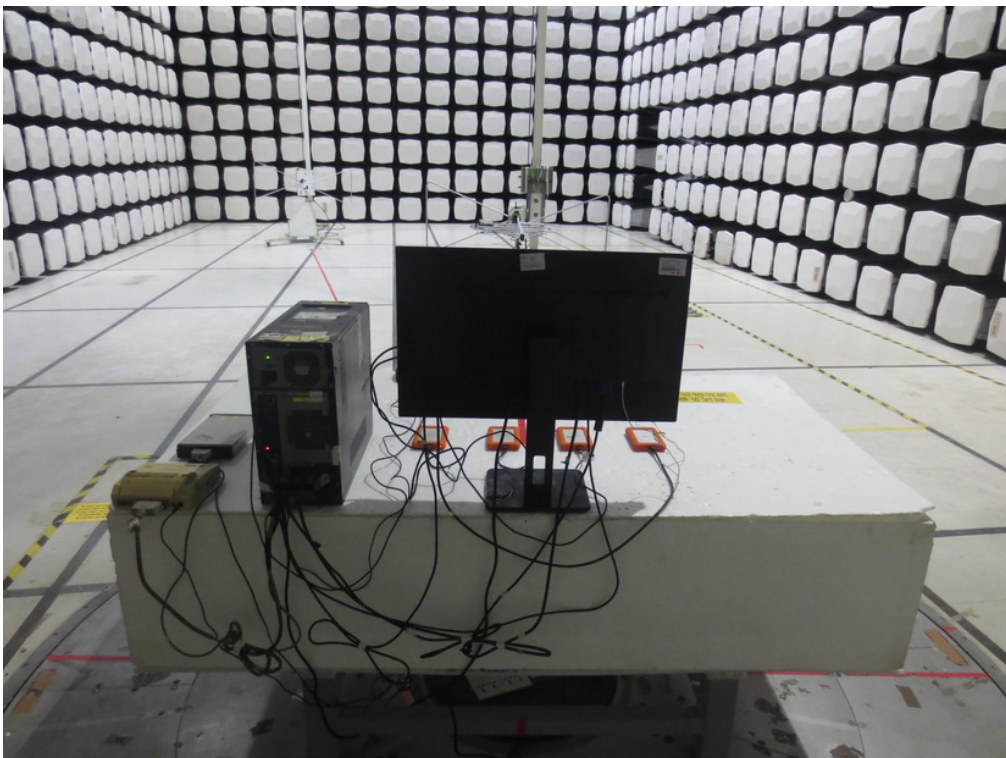
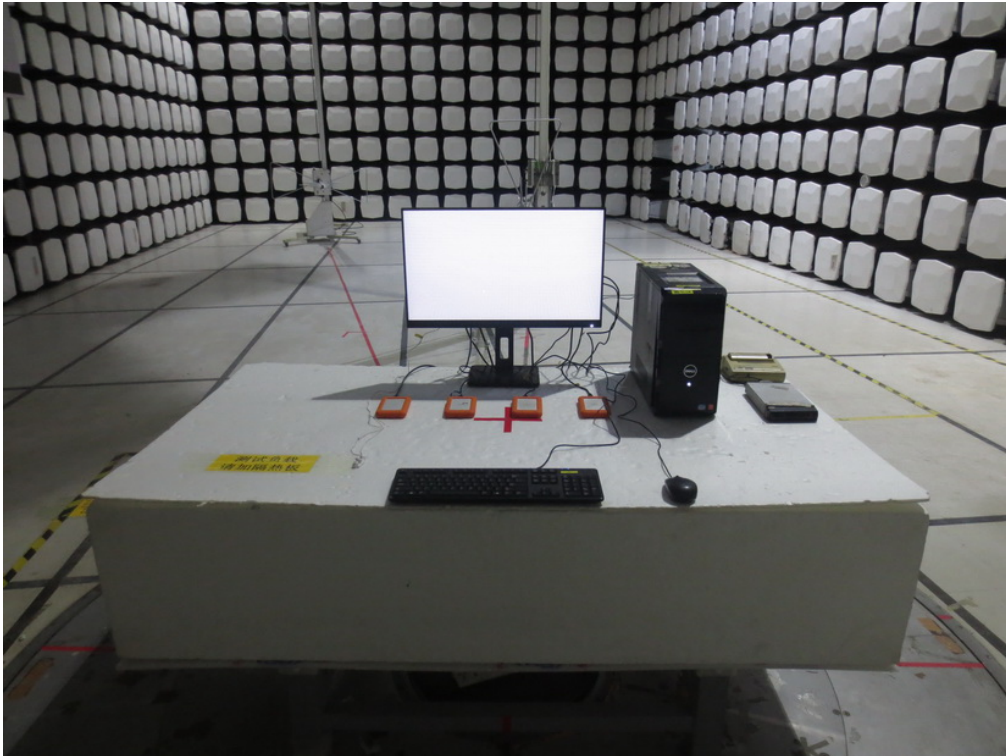

Radiated Emissions Above 1 GHz

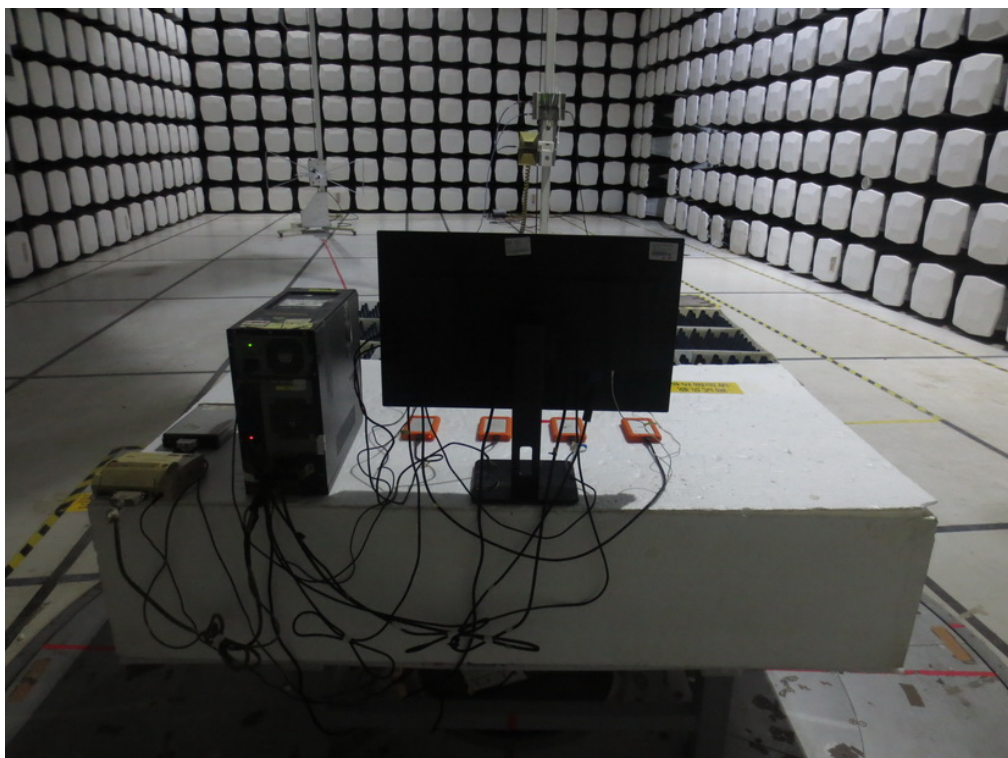

End of Test Report